

SPECIFICATION CONTROL DRAWING

55A0813

TITLE	WIRE, RADIATION-CROSSLINKED, MODIFIED ETFE-INSULATED, NORMAL WEIGHT, GENERAL PURPOSE, 600 VOLT	Date	28MAR11	Revision	R1
-------	--	------	---------	----------	----

This specification sheet forms a part of the latest issue of Raychem Specification 55A.

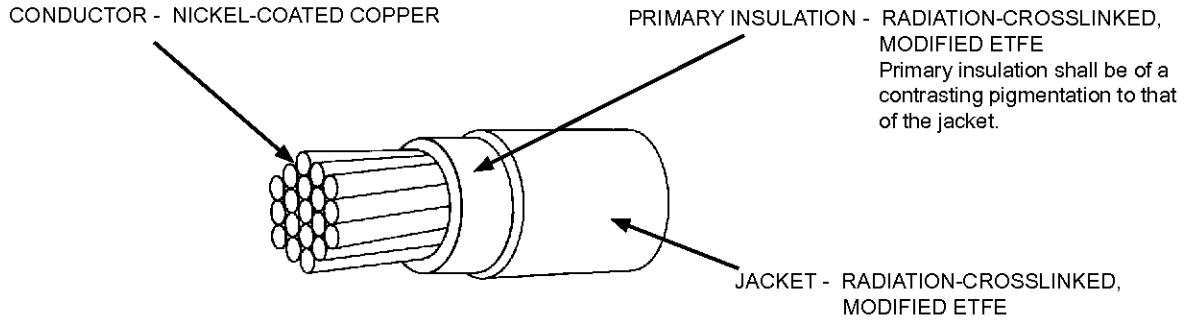

TABLE I. CONSTRUCTION DETAILS

PART NUMBER 1/	WIRE SIZE (AWG)	CONDUCTOR STRANDING (number x AWG)	DIAMETER OF STRANDED CONDUCTOR (in.)		FINISHED WIRE		
			MINIMUM	MAXIMUM	MAXIMUM RESISTANCE AT 20°C (ohms/1000 ft.)	DIAMETER (in.)	MAXIMUM WEIGHT (lbs/1000 ft.)
55A0813-26-*	26	19 x 38	.018	.020	42.2	.040 ± .002	1.7
55A0813-24-*	24	19 x 36	.023	.025	25.9	.045 ± .002	2.3
55A0813-22-*	22	19 x 34	.029	.031	16.0	.050 ± .002	3.2
55A0813-20-*	20	19 x 32	.037	.039	9.77	.058 ± .002	4.7
55A0813-18-*	18	19 x 30	.046	.049	6.10	.070 ± .003	7.2
55A0813-16-*	16	19 x 29	.052	.055	4.76	.077 ± .003	9.0
55A0813-14-*	14	19 x 27	.065	.069	3.00	.094 ± .003	13.8
55A0813-12-*	12	37 x 28	.084	.089	1.98	.111 ± .003	20.5
55A0813-10-*	10	37 x 26	.106	.113	1.24	.134 ± .004	32.4
55A0813- 8-*	8	133 x 29	.158	.173	.694	.195 ± .008	64.2
55A0813- 6-*	6	133 x 27	.198	.217	.436	.241 ± .010	96.8
55A0813- 4-*	4	133 x 25	.250	.274	.275	.310 ± .010	163.
55A0813- 2-*	2	665 x 30	.320	.340	.177	.408 ± .012	256.
55A0813- 1-*	1	817 x 30	.360	.380	.144	.470 ± .012	325.
55A0813- 0-*	0	1045 x 30	.395	.425	.113	.510 ± .016	427.
55A0813-00-*	00	1330 x 30	.440	.475	.089	.570 ± .016	531.
55A0813-000-*	000	1665 x 30	.500	.540	.071	.610 ± .016	616.
55A0813-0000-*	0000	2109 x 30	.565	.605	.056	.675 ± .022	763.

Users should evaluate the suitability of this product for their application. Specifications are subject to change without notice. TE Connectivity also reserves the right to make changes in materials or processing, which do not affect compliance with any specification, without notification to Buyer.

1/ COLORS AND COLOR CODE DESIGNATORS SHALL BE IN ACCORDANCE WITH MIL-STD-681. OTHER CODES AND SUFFIXES MAY BE ADDED TO THE PART NUMBER. AS NECESSARY, TO CAPTURE ANY ADDITIONAL REQUIREMENTS IMPOSED BY THE PURCHASE ORDER.

The TE logo, TE Connectivity and Raychem are trademarks.

DIMENSIONS ARE IN INCHES, AND UNLESS OTHERWISE DESIGNATED ARE NOMINAL.

THIS SPECIFICATION SHEET TAKES PRECEDENCE OVER DOCUMENTS REFERENCED HEREIN. REFERENCED DOCUMENTS SHALL BE OF THE ISSUE IN EFFECT ON DATE OF INVITATION FOR BID.

TE TE Connectivity Wire & Cable
501 Oaks Avenue
Redwood City, CA 94063-3800
Phone: 1-800-227-8816
Fax: 1-650-361-6297

TABLE II. PERFORMANCE DETAILS

PART NUMBER 1/	BEND TESTING			
	MANDREL DIAMETER (inch) (± 3%)		WEIGHT (lb) (± 3%)	
	IMMERSION, LIFE CYCLE AND ACCELERATED AGING	COLD BEND	IMMERSION, LIFE CYCLE AND ACCELERATED AGING	COLD BEND
55A0813-26-*	.375	1.00	.500	3.00
55A0813-24-*	.500	1.00	.750	3.00
55A0813-22-*	.500	1.00	1.00	3.00
55A0813-20-*	.500	1.00	1.50	4.00
55A0813-18-*	.750	1.50	2.00	4.00
55A0813-16-*	1.00	1.50	2.00	5.00
55A0813-14-*	1.00	2.00	3.00	5.00
55A0813-12-*	1.50	2.00	3.00	5.00
55A0813-10-*	2.00	3.00	3.00	5.00
55A0813- 8-*	3.00	4.00	4.00	6.00
55A0813- 6-*	4.00	5.00	4.00	10.0
55A0813- 4-*	5.00	6.00	4.00	10.0
55A0813- 2-*	6.00	8.00	6.00	15.0
55A0813- 1-*	8.00	10.0	6.00	15.0
55A0813- 0-*	8.00	10.0	6.00	15.0
55A0813-00-*	10.0	12.0	8.00	20.0
55A0813-000-*	10.0	12.0	8.00	20.0
55A0813-0000-*	10.0	12.0	8.00	20.0

WIRE RATINGS AND ADDITIONAL REQUIREMENTS

TEMPERATURE RATING: 200°C

Maximum continuous conductor temperature

VOLTAGE RATING: 600 volts (rms) at sea level

ACCELERATED AGING (CROSSLINKING PROOF): 300 ± 3°C for 7 hours

BLOCKING: 230 ± 3°C for 24 hours

COLOR: White preferred

CONCENTRICITY: 70% (minimum)

FLAMMABILITY: Procedure 1, 3 seconds (maximum); 3 inches (maximum); no flaming of facial tissue

HUMIDITY RESISTANCE: Insulation Resistance,

5000 megohms for 1000 ft. (minimum), AWG 26 - 10,

3000 megohms for 1000 ft. (minimum), AWG 8 - 0000

IDENTIFICATION, COLOR STRIPING AND BAND DURABILITY:

125 cycles (250 strokes) (minimum), 500 g weight

IMMERSION: Diameter increase 5% (maximum); no cracking, no dielectric breakdown

INSULATION ELONGATION AND TENSILE STRENGTH:

Tensile strength, 5000 lbf/in² (minimum) for primary insulation

5000 lbf/in² (minimum) for total insulation (primary insulation and jacket)

Elongation, 125% (minimum) for primary insulation, AWG 26 - 10 only

75% (minimum) for total insulation (primary insulation and jacket)

INSULATION FLAWS:

Primary Insulation,

Spark Test, 1.5 kV (rms) at 60 Hz

4.2 kV (rms) at 3 kHz

Impulse Dielectric Test, 6.0 kV (peak)

Finished Wire,

Spark Test, 5.7 kV (rms) at 3 kHz

Impulse Dielectric Test, 8.0 kV (peak)

INSULATION RESISTANCE:

5000 megohms for 1000 ft. (minimum), AWG 26 - 10

3000 megohms for 1000 ft. (minimum), AWG 8 - 0000

INSULATION THICKNESS: 0.003 in. (minimum) for primary insulation

0.004 in. (minimum) for outer jacket

0.009 in. (minimum) for total insulation

LIFE CYCLE: 230 ± 3°C for 500 hours

LOW TEMPERATURE-COLD BEND: -65 ± 3°C for 4 hours

SHRINKAGE: 230 ± 3°C, for 6 hours, 0.125 in. (maximum) in 12 inches

SMOKE TEST: 250 ± 5°C, no visible smoke

SURFACE RESISTANCE: 500 megohms-in. (minimum), both readings

THERMAL SHOCK RESISTANCE: 200 ± 3°C,

0.060 in. (maximum), AWG 26 - 12

0.100 in. (maximum), AWG 10 - 8

0.125 in. (maximum), AWG 6 - 0000

VOLTAGE WITHSTAND TEST (Post Environmental): 2500 volts (rms), 60 Hz

WICKING: 2.25 in. (maximum)

WRAP TEST: 313 ± 3°C for 2 hours

PART NUMBER:

The "*" in the part numbers on pages 1 and 2 shall be replaced by a color code designator.

1/ Example: AWG 22, white; 55A0813-22-9

AWG 22, white with a black stripe; 55A0813-22-90

1/ See footer section on page 1



Компания «ЭлектроПласт» предлагает заключение долгосрочных отношений при поставках импортных электронных компонентов на взаимовыгодных условиях!

Наши преимущества:

- Оперативные поставки широкого спектра электронных компонентов отечественного и импортного производства напрямую от производителей и с крупнейших мировых складов;
- Поставка более 17-ти миллионов наименований электронных компонентов;
- Поставка сложных, дефицитных, либо снятых с производства позиций;
- Оперативные сроки поставки под заказ (от 5 рабочих дней);
- Экспресс доставка в любую точку России;
- Техническая поддержка проекта, помощь в подборе аналогов, поставка прототипов;
- Система менеджмента качества сертифицирована по Международному стандарту ISO 9001;
- Лицензия ФСБ на осуществление работ с использованием сведений, составляющих государственную тайну;
- Поставка специализированных компонентов (Xilinx, Altera, Analog Devices, Intersil, Interpoint, Microsemi, Aeroflex, Peregrine, Syfer, Eurofarad, Texas Instrument, Miteq, Cobham, E2V, MA-COM, Hittite, Mini-Circuits, General Dynamics и др.);

Помимо этого, одним из направлений компании «ЭлектроПласт» является направление «Источники питания». Мы предлагаем Вам помощь Конструкторского отдела:

- Подбор оптимального решения, техническое обоснование при выборе компонента;
- Подбор аналогов;
- Консультации по применению компонента;
- Поставка образцов и прототипов;
- Техническая поддержка проекта;
- Защита от снятия компонента с производства.



Как с нами связаться

Телефон: 8 (812) 309 58 32 (многоканальный)

Факс: 8 (812) 320-02-42

Электронная почта: org@eplast1.ru

Адрес: 198099, г. Санкт-Петербург, ул. Калинина, дом 2, корпус 4, литера А.