



# BUK7610-55AL

N-channel TrenchMOS standard level FET

Rev. 02 — 9 January 2008

Product data sheet

## 1. Product profile

### 1.1 General description

N-channel enhancement mode Field-Effect Transistor (FET) in a plastic package using Nexperia General-Purpose Automotive (GPA) TrenchMOS technology specifically optimized for linear operation. This product has been designed and qualified to the appropriate AEC standard for use in automotive critical applications.

### 1.2 Features

- 175 °C rated
- Stable operation in linear mode
- Q101 compliant
- TrenchMOS technology

### 1.3 Applications

- 12 V and 24 V loads
- DC linear motor control
- Automotive systems
- Repetitive clamped inductive switching

### 1.4 Quick reference data

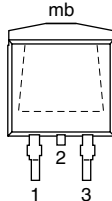
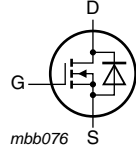
Table 1. Quick reference

Symbol	Parameter	Conditions	Min	Typ	Max	Unit
$I_D$	drain current	$V_{GS} = 10\text{ V}$ ; $T_{mb} = 25\text{ °C}$ ; see <a href="#">Figure 4</a> and <a href="#">1</a>	[1]	-	75	A
$P_{tot}$	total power dissipation	$T_{mb} = 25\text{ °C}$ ; see <a href="#">Figure 2</a>	-	-	300	W
<b>Avalanche ruggedness</b>						
$E_{DS(AL)S}$	non-repetitive drain-source avalanche energy	$I_D = 75\text{ A}$ ; $V_{sup} \leq 55\text{ V}$ ; $R_{GS} = 50\ \Omega$ ; $V_{GS} = 10\text{ V}$ ; $T_{j(init)} = 25\text{ °C}$ ; unclamped inductive load	-	-	1.1	J
<b>Static characteristics</b>						
$R_{DSon}$	drain-source on-state resistance	$V_{GS} = 10\text{ V}$ ; $I_D = 25\text{ A}$ ; $T_j = 25\text{ °C}$ ; see <a href="#">Figure 12</a> and <a href="#">13</a>	-	8.5	10	m $\Omega$

[1] Continuous current is limited by package.

## 2. Pinning information

Table 2. Pinning

Pin	Symbol	Description	Simplified outline	Graphic symbol
1	G	gate		
2	D	drain		
3	S	source		
mb	D	mounting base; connected to drain		

SOT404 (D2PAK)

## 3. Ordering information

Table 3. Ordering information

Type number	Package		Version
	Name	Description	
BUK7610-55AL	D2PAK	plastic single-ended surface-mounted package (D2PAK); 3 leads (one lead cropped)	SOT404

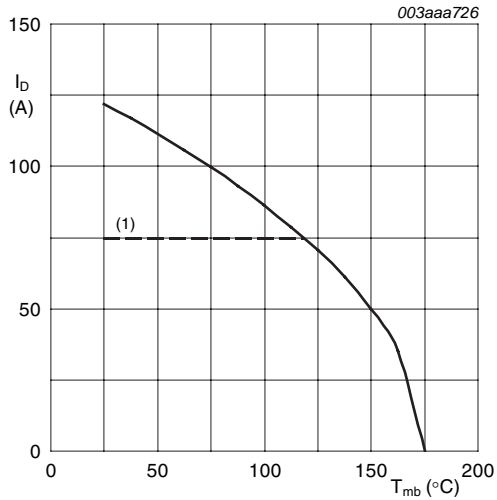
## 4. Limiting values

Table 4. Limiting values

In accordance with the Absolute Maximum Rating System (IEC 60134).

Symbol	Parameter	Conditions	Min	Max	Unit
$V_{DS}$	drain-source voltage	$T_j \geq 25\text{ °C}$ ; $T_j \leq 175\text{ °C}$	-	55	V
$V_{DGR}$	drain-gate voltage	$R_{GS} = 20\text{ k}\Omega$	-	55	V
$V_{GS}$	gate-source voltage		-20	20	V
$I_D$	drain current	$T_{mb} = 25\text{ °C}$ ; $V_{GS} = 10\text{ V}$ ; see <a href="#">Figure 4</a> and <a href="#">1</a>	<a href="#">[1][2]</a>	122	A
		$T_{mb} = 25\text{ °C}$ ; $V_{GS} = 10\text{ V}$ ; see <a href="#">Figure 4</a> and <a href="#">1</a>	<a href="#">[3]</a>	75	A
		$T_{mb} = 100\text{ °C}$ ; $V_{GS} = 10\text{ V}$ ; see <a href="#">Figure 4</a>	<a href="#">[3]</a>	75	A
$I_{DM}$	peak drain current	$T_{mb} = 25\text{ °C}$ ; $t_p \leq 10\text{ }\mu\text{s}$ ; pulsed	-	490	A
$P_{tot}$	total power dissipation	$T_{mb} = 25\text{ °C}$ ; see <a href="#">Figure 2</a>	-	300	W
$T_{stg}$	storage temperature		-55	175	°C
$T_j$	junction temperature		-55	175	°C
<b>Avalanche ruggedness</b>					
$E_{DS(AL)S}$	non-repetitive drain-source avalanche energy	$I_D = 75\text{ A}$ ; $V_{sup} \leq 55\text{ V}$ ; $R_{GS} = 50\text{ }\Omega$ ; $V_{GS} = 10\text{ V}$ ; $T_{j(init)} = 25\text{ °C}$ ; unclamped inductive load	-	1.1	J
$E_{DS(AL)R}$	repetitive drain-source avalanche energy	see <a href="#">Figure 3</a>	<a href="#">[4][5]</a> <a href="#">[6]</a>	-	J
<b>Source-drain diode</b>					
$I_S$	source current	$T_{mb} = 25\text{ °C}$	<a href="#">[1][2]</a>	122	A
		$T_{mb} = 25\text{ °C}$	<a href="#">[3]</a>	-	
$I_{SM}$	peak source current	$t_p \leq 10\text{ }\mu\text{s}$ ; pulsed; $T_{mb} = 25\text{ °C}$	-	490	A

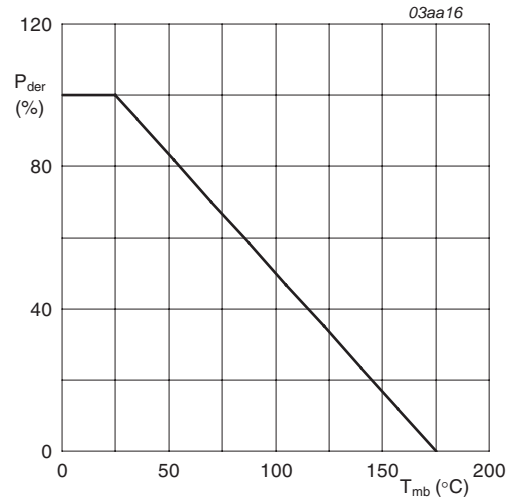
- [1] Current is limited by power dissipation chip rating.
- [2] Refer to document 9397 750 12572 for further information.
- [3] Continuous current is limited by package.
- [4] Single shot avalanche rating limited by maximum junction temperature of 175 °C.
- [5] Repetitive avalanche rating limited by average junction temperature of 170 °C.
- [6] Refer to application note AN10273 for further information.



$V_{GS} \geq 10 V$

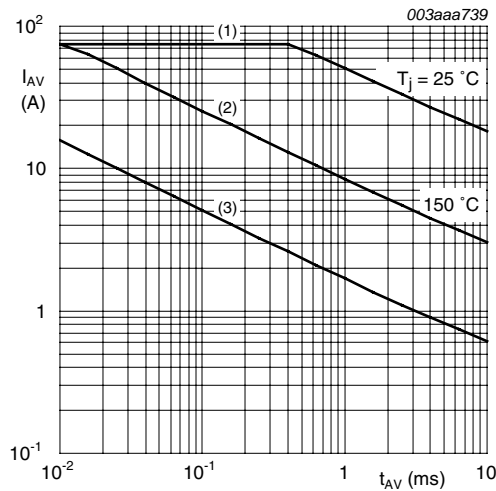
(1) Capped at 75 A due to package.

**Fig 1. Continuous drain current as a function of mounting base temperature**



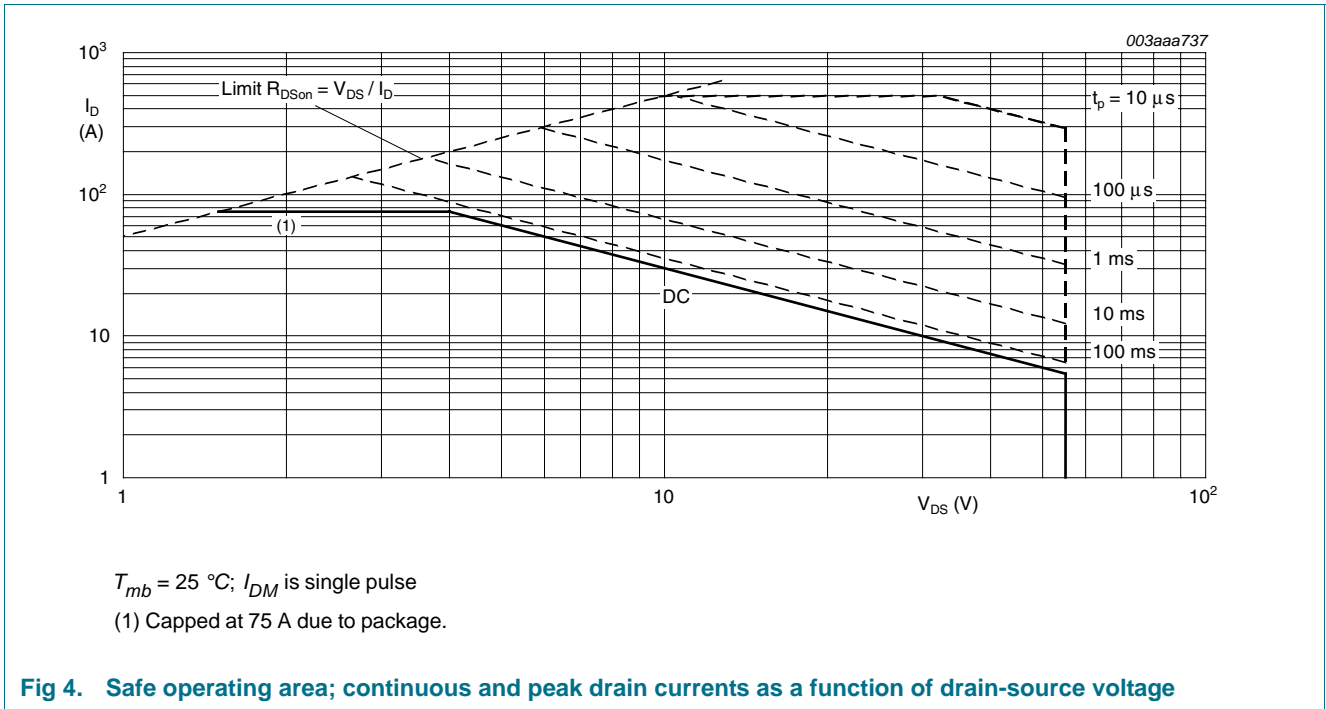
$$P_{der} = \frac{P_{tot}}{P_{tot(25^{\circ}C)}} \times 100 \%$$

**Fig 2. Normalized total power dissipation as a function of mounting base temperature**



- (1) Single-shot.
- (2) Single-shot.
- (3) Repetitive.

**Fig 3. Single-shot and repetitive avalanche rating; avalanche current as a function of a**



## 5. Thermal characteristics

**Table 5. Thermal characteristics**

Symbol	Parameter	Conditions	Min	Typ	Max	Unit
$R_{th(j-a)}$	thermal resistance from junction to ambient	mounted on a printed-circuit board; minimum footprint; vertical in still air	-	50	-	K/W
$R_{th(j-mb)}$	thermal resistance from junction to mounting base	see <a href="#">Figure 5</a>	-	0.25	0.5	K/W

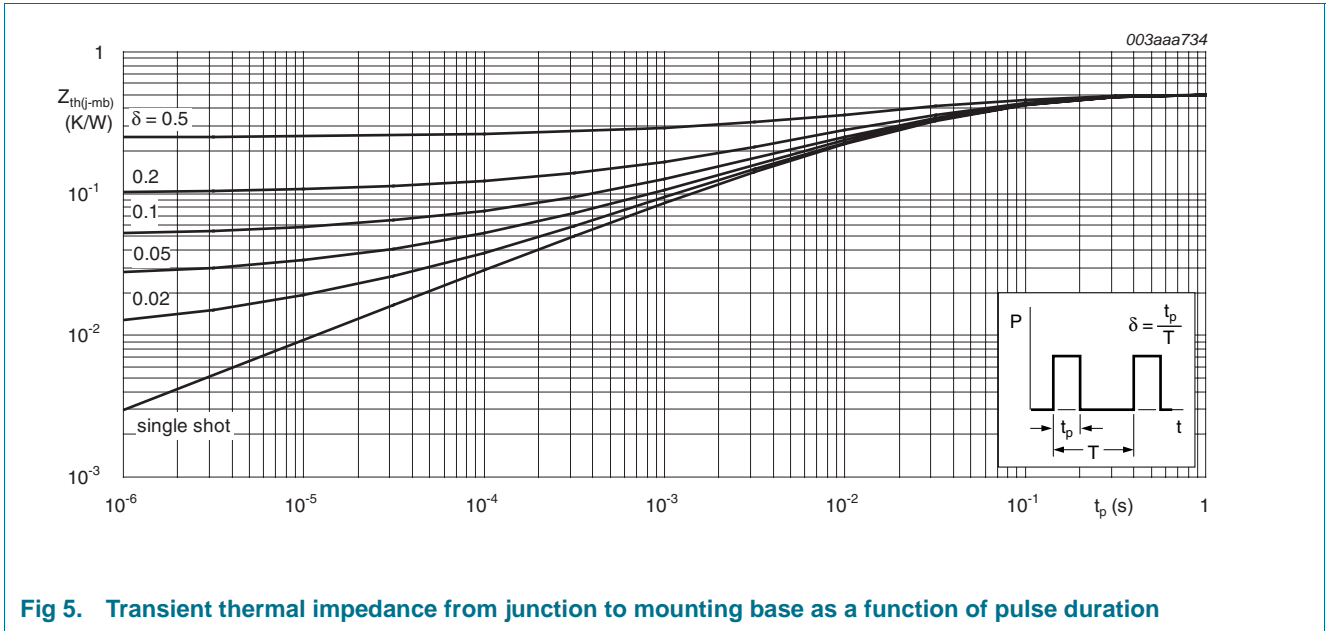


Fig 5. Transient thermal impedance from junction to mounting base as a function of pulse duration

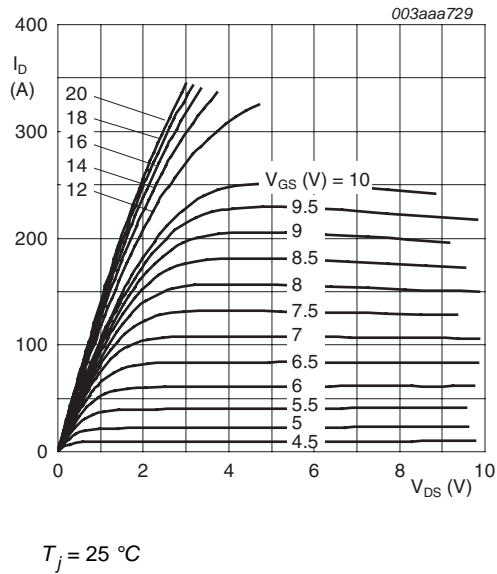
## 6. Characteristics

Table 6. Characteristics

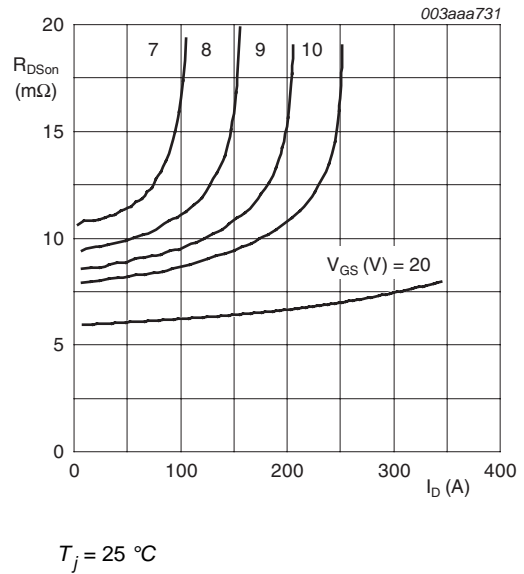
Symbol	Parameter	Conditions	Min	Typ	Max	Unit
<b>Static characteristics</b>						
$V_{(BR)DSS}$	drain-source breakdown voltage	$I_D = 250 \mu A; V_{GS} = 0 V; T_j = -55 \text{ }^\circ C$	50	-	-	V
		$I_D = 250 \mu A; V_{GS} = 0 V; T_j = 25 \text{ }^\circ C$	55	-	-	V
$V_{GS(th)}$	gate-source threshold voltage	$I_D = 1 \text{ mA}; V_{DS} = V_{GS}; T_j = 25 \text{ }^\circ C$ ; see <a href="#">Figure 10</a> and <a href="#">11</a>	2	3	4	V
		$I_D = 1 \text{ mA}; V_{DS} = V_{GS}; T_j = 175 \text{ }^\circ C$ ; see <a href="#">Figure 10</a> and <a href="#">11</a>	1	-	-	V
		$I_D = 1 \text{ mA}; V_{DS} = V_{GS}; T_j = -55 \text{ }^\circ C$ ; see <a href="#">Figure 10</a> and <a href="#">11</a>	-	-	4.4	V
$I_{DSS}$	drain leakage current	$V_{DS} = 55 \text{ V}; V_{GS} = 0 \text{ V}; T_j = 175 \text{ }^\circ C$	-	-	500	$\mu A$
		$V_{DS} = 55 \text{ V}; V_{GS} = 0 \text{ V}; T_j = 25 \text{ }^\circ C$	-	0.05	10	$\mu A$
$I_{GSS}$	gate leakage current	$V_{DS} = 0 \text{ V}; V_{GS} = +20 \text{ V}; T_j = 25 \text{ }^\circ C$	-	2	100	nA
		$V_{DS} = 0 \text{ V}; V_{GS} = -20 \text{ V}; T_j = 25 \text{ }^\circ C$	-	2	100	nA
$R_{DSon}$	drain-source on-state resistance	$V_{GS} = 10 \text{ V}; I_D = 25 \text{ A}; T_j = 175 \text{ }^\circ C$ ; see <a href="#">Figure 12</a> and <a href="#">13</a>	-	-	20	m $\Omega$
		$V_{GS} = 10 \text{ V}; I_D = 25 \text{ A}; T_j = 25 \text{ }^\circ C$ ; see <a href="#">Figure 12</a> and <a href="#">13</a>	-	8.5	10	m $\Omega$

Table 6. Characteristics ...continued

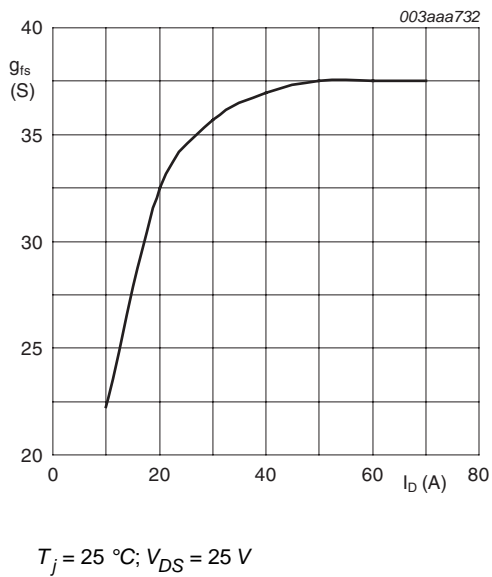
Symbol	Parameter	Conditions	Min	Typ	Max	Unit
<b>Source-drain diode</b>						
$V_{SD}$	source-drain voltage	$I_S = 25\text{ A}$ ; $V_{GS} = 0\text{ V}$ ; $T_j = 25\text{ °C}$ ; see <a href="#">Figure 16</a>	-	0.85	1.2	V
$t_{rr}$	reverse recovery time	$I_S = 20\text{ A}$ ; $di_S/dt = -100\text{ A}/\mu\text{s}$ ; $V_{GS} = 0\text{ V}$ ; $V_{DS} = 30\text{ V}$ ; $T_j = 25\text{ °C}$	-	73	-	ns
$Q_r$	recovered charge	$I_S = 20\text{ A}$ ; $di_S/dt = -100\text{ A}/\mu\text{s}$ ; $V_{GS} = 0\text{ V}$ ; $V_{DS} = 30\text{ V}$ ; $T_j = 25\text{ °C}$	-	430	-	nC
<b>Dynamic characteristics</b>						
$Q_{G(\text{tot})}$	total gate charge	$I_D = 25\text{ A}$ ; $V_{DS} = 44\text{ V}$ ; $V_{GS} = 10\text{ V}$ ; $T_j = 25\text{ °C}$ ; see <a href="#">Figure 14</a>	-	124	-	nC
$Q_{GS}$	gate-source charge	$I_D = 25\text{ A}$ ; $V_{DS} = 44\text{ V}$ ; $V_{GS} = 10\text{ V}$ ; $T_j = 25\text{ °C}$ ; see <a href="#">Figure 14</a>	-	22	-	nC
$Q_{GD}$	gate-drain charge	$I_D = 25\text{ A}$ ; $V_{DS} = 44\text{ V}$ ; $V_{GS} = 10\text{ V}$ ; $T_j = 25\text{ °C}$ ; see <a href="#">Figure 14</a>	-	50	-	nC
$V_{GS(\text{pl})}$	gate-source plateau voltage	$I_D = 25\text{ A}$ ; $V_{DS} = 44\text{ V}$ ; $T_j = 25\text{ °C}$ ; see <a href="#">Figure 14</a>	-	5	-	V
$C_{iss}$	input capacitance	$V_{GS} = 0\text{ V}$ ; $V_{DS} = 25\text{ V}$ ; $f = 1\text{ MHz}$ ; $T_j = 25\text{ °C}$ ; see <a href="#">Figure 15</a>	-	4710	6280	pF
$C_{oss}$	output capacitance	$V_{GS} = 0\text{ V}$ ; $V_{DS} = 25\text{ V}$ ; $f = 1\text{ MHz}$ ; $T_j = 25\text{ °C}$ ; see <a href="#">Figure 15</a>	-	980	1180	pF
$C_{rss}$	reverse transfer capacitance	$V_{GS} = 0\text{ V}$ ; $V_{DS} = 25\text{ V}$ ; $f = 1\text{ MHz}$ ; $T_j = 25\text{ °C}$ ; see <a href="#">Figure 15</a>	-	560	770	pF
$t_{d(\text{on})}$	turn-on delay time	$V_{DS} = 30\text{ V}$ ; $R_L = 1.2\ \Omega$ ; $V_{GS} = 10\text{ V}$ ; $R_{G(\text{ext})} = 10\ \Omega$ ; $T_j = 25\text{ °C}$	-	33	-	ns
$t_r$	rise time	$V_{DS} = 30\text{ V}$ ; $R_L = 1.2\ \Omega$ ; $V_{GS} = 10\text{ V}$ ; $R_{G(\text{ext})} = 10\ \Omega$ ; $T_j = 25\text{ °C}$	-	117	-	ns
$t_{d(\text{off})}$	turn-off delay time	$V_{DS} = 30\text{ V}$ ; $R_L = 1.2\ \Omega$ ; $V_{GS} = 10\text{ V}$ ; $R_{G(\text{ext})} = 10\ \Omega$ ; $T_j = 25\text{ °C}$	-	132	-	ns
$t_f$	fall time	$V_{DS} = 30\text{ V}$ ; $R_L = 1.2\ \Omega$ ; $V_{GS} = 10\text{ V}$ ; $R_{G(\text{ext})} = 10\ \Omega$ ; $T_j = 25\text{ °C}$	-	95	-	ns
$L_D$	internal drain inductance	from upper edge of drain mounting base to center of die; $T_j = 25\text{ °C}$	-	2.5	-	nH
$L_S$	internal source inductance	from source lead to source bond pad; $T_j = 25\text{ °C}$	-	7.5	-	nH



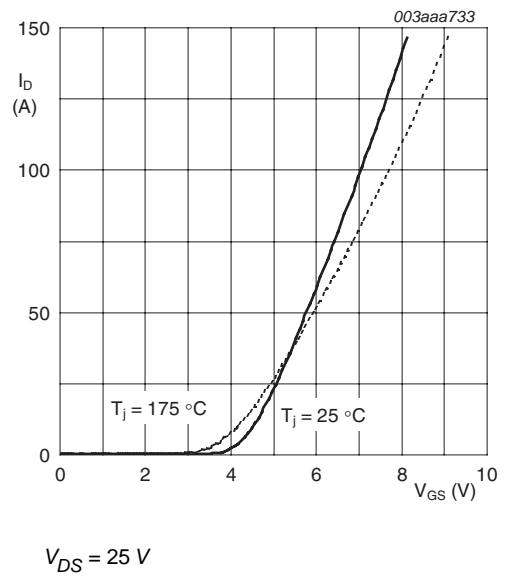
**Fig 6. Output characteristics: drain current as a function of drain-source voltage; typical values**



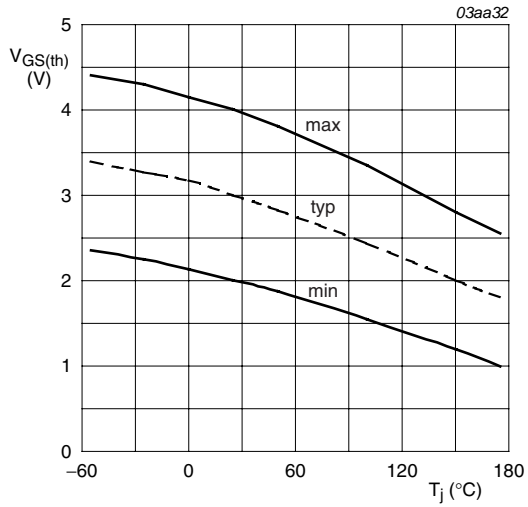
**Fig 7. Drain-source on-state resistance as a function of drain current; typical values**



**Fig 8. Forward transconductance as a function of drain current; typical values**

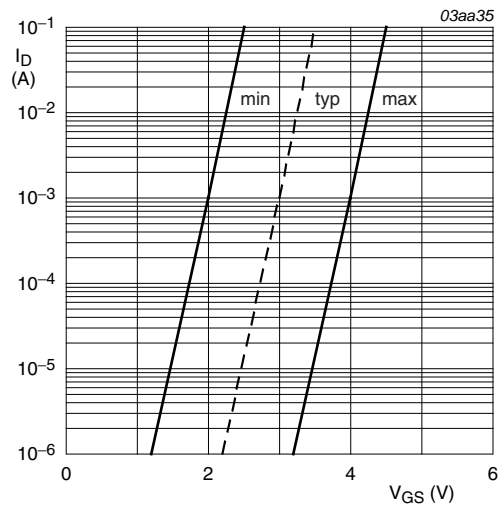


**Fig 9. Transfer characteristics: drain current as a function of gate-source voltage; typical values**



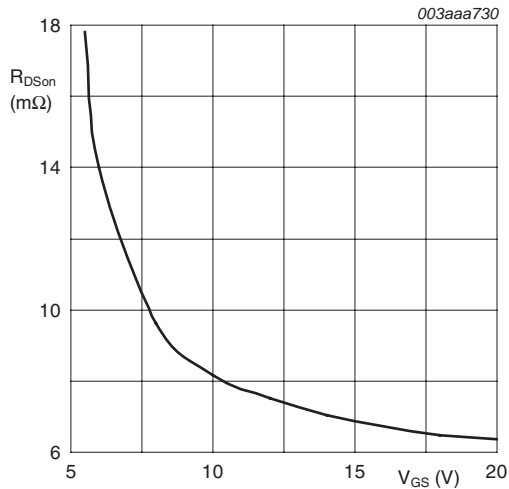
$I_D = 1 \text{ mA}; V_{DS} = V_{GS}$

**Fig 10. Gate-source threshold voltage as a function of junction temperature**



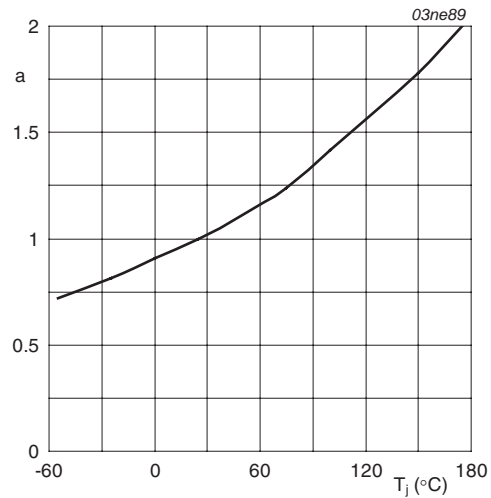
$T_j = 25 \text{ °C}; V_{DS} = V_{GS}$

**Fig 11. Sub-threshold drain current as a function of gate-source voltage**



$T_j = 25 \text{ °C}; I_D = 25 \text{ A}$

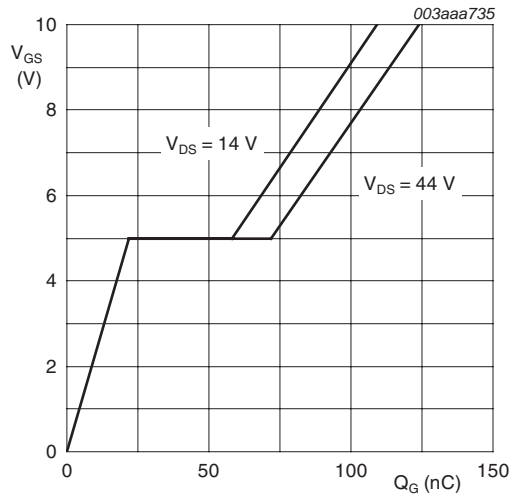
**Fig 12. Drain-source on-state resistance as a function of gate-source voltage; typical values**



$$a = \frac{R_{DSon}}{R_{DSon(25\text{°C})}}$$

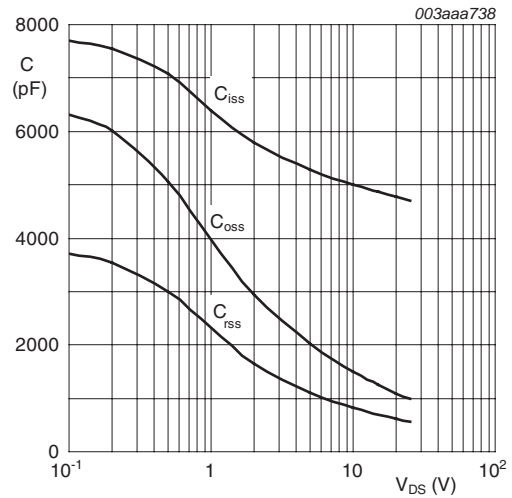
**Fig 13. Normalized drain-source on-state resistance factor as a function of junction temperature**





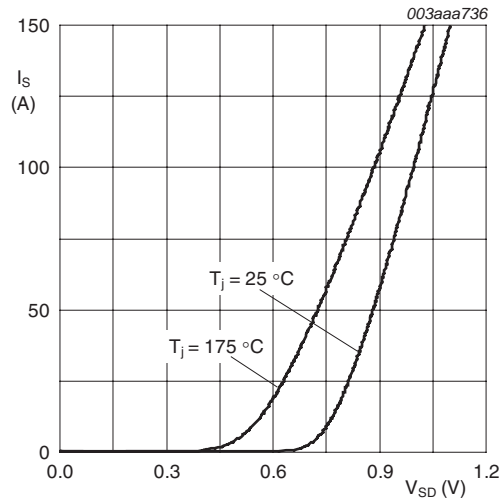
$T_j = 25\text{ }^\circ\text{C}; I_D = 25\text{ A}$

**Fig 14. Gate-source voltage as a function of gate charge; typical values**



$V_{GS} = 0\text{ V}; f = 1\text{ MHz}$

**Fig 15. Input, output and reverse transfer capacitances as a function of drain-source voltage; typical values**



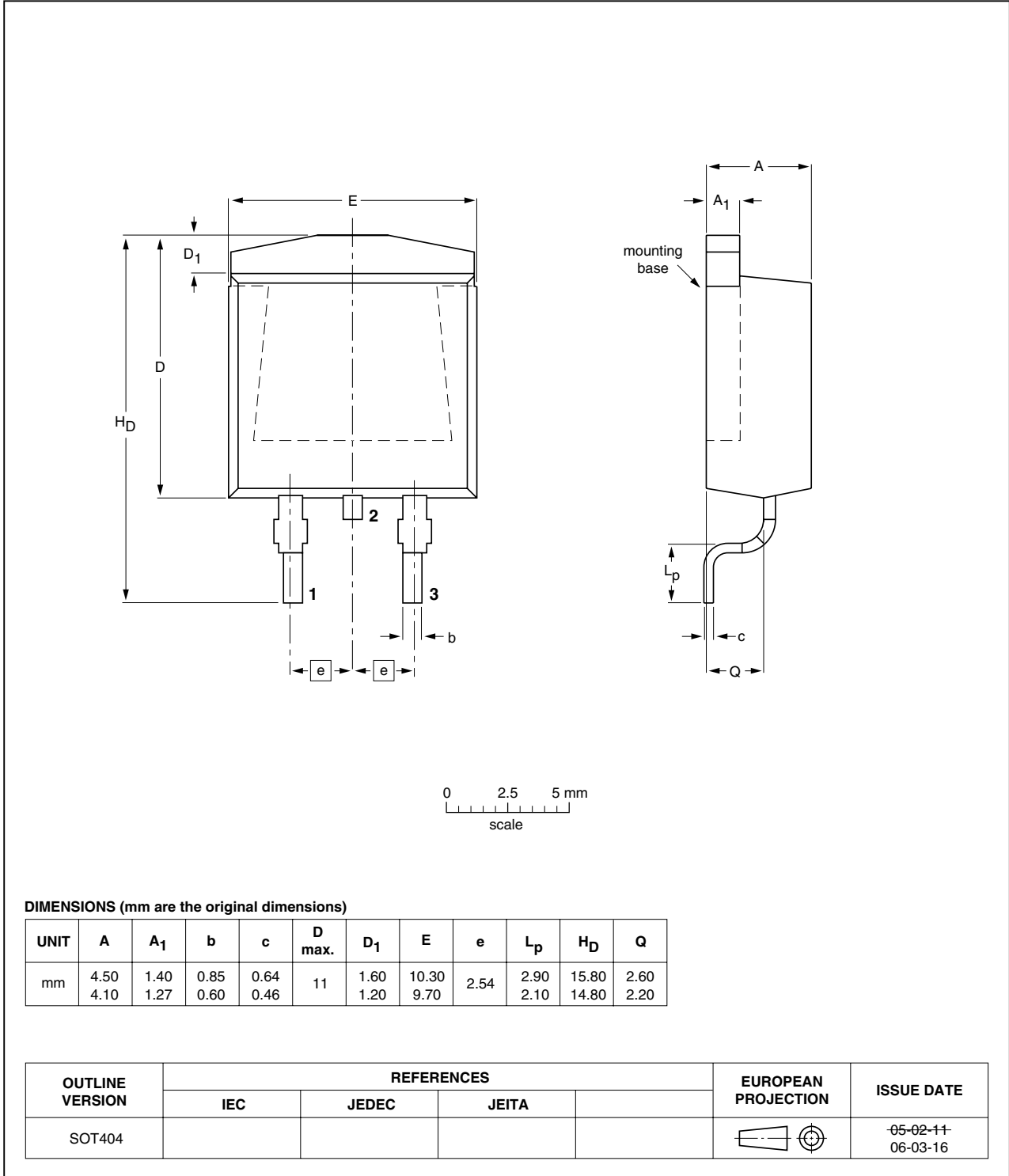
$V_{GS} = 0\text{ V}$

**Fig 16. Source current as a function of source-drain voltage; typical values**

**7. Package outline**

Plastic single-ended surface-mounted package (D2PAK); 3 leads (one lead cropped)

**SOT404**



**Fig 17. Package outline SOT404 (D2PAK)**

## 8. Revision history

Table 7. Revision history

Document ID	Release date	Data sheet status	Change notice	Supersedes
BUK7610-55AL_2	20080109	Product data sheet	-	BUK75_7610_55AL_1
Modifications:		<ul style="list-style-type: none"><li>• The format of this data sheet has been redesigned to comply with the new identity guidelines of NXP Semiconductors.</li><li>• Legal texts have been adapted to the new company name where appropriate.</li><li>• Typical thermal resistance (j-mb) figure added in <a href="#">Table 5</a>.</li></ul>		
BUK75_7610_55AL_1	20041022	Product data sheet	-	-

## 9. Legal information

### 9.1 Data sheet status

Document status <sup>[1][2]</sup>	Product status <sup>[3]</sup>	Definition
Objective [short] data sheet	Development	This document contains data from the objective specification for product development.
Preliminary [short] data sheet	Qualification	This document contains data from the preliminary specification.
Product [short] data sheet	Production	This document contains the product specification.

[1] Please consult the most recently issued document before initiating or completing a design.

[2] The term 'short data sheet' is explained in section "Definitions".

[3] The product status of device(s) described in this document may have changed since this document was published and may differ in case of multiple devices. The latest product status information is available on the internet at URL <http://www.nexperia.com>.

### 9.2 Definitions

**Draft** — The document is a draft version only. The content is still under internal review and subject to formal approval, which may result in modifications or additions. Nexperia does not give any representations or warranties as to the accuracy or completeness of information included herein and shall have no liability for the consequences of use of such information.

**Short data sheet** — A short data sheet is an extract from a full data sheet with the same product type number(s) and title. A short data sheet is intended for quick reference only and should not be relied upon to contain detailed and full information. For detailed and full information see the relevant full data sheet, which is available on request via the local Nexperia sales office. In case of any inconsistency or conflict with the short data sheet, the full data sheet shall prevail.

### 9.3 Disclaimers

**General** — Information in this document is believed to be accurate and reliable. However, Nexperia does not give any representations or warranties, expressed or implied, as to the accuracy or completeness of such information and shall have no liability for the consequences of use of such information.

**Right to make changes** — Nexperia reserves the right to make changes to information published in this document, including without limitation specifications and product descriptions, at any time and without notice. This document supersedes and replaces all information supplied prior to the publication hereof.

**Suitability for use** — Nexperia products are not designed, authorized or warranted to be suitable for use in medical, military, aircraft, space or life support equipment, nor in applications where failure or malfunction of a Nexperia product can reasonably be expected to

result in personal injury, death or severe property or environmental damage. Nexperia accepts no liability for inclusion and/or use of Nexperia products in such equipment or applications and therefore such inclusion and/or use is at the customer's own risk.

**Applications** — Applications that are described herein for any of these products are for illustrative purposes only. Nexperia makes no representation or warranty that such applications will be suitable for the specified use without further testing or modification.

**Limiting values** — Stress above one or more limiting values (as defined in the Absolute Maximum Ratings System of IEC 60134) may cause permanent damage to the device. Limiting values are stress ratings only and operation of the device at these or any other conditions above those given in the Characteristics sections of this document is not implied. Exposure to limiting values for extended periods may affect device reliability.

**Terms and conditions of sale** — Nexperia products are sold subject to the general terms and conditions of commercial sale, as published at <http://www.nexperia.com/profile/terms>, including those pertaining to warranty, intellectual property rights infringement and limitation of liability, unless explicitly otherwise agreed to in writing by Nexperia. In case of any inconsistency or conflict between information in this document and such terms and conditions, the latter will prevail.

**No offer to sell or license** — Nothing in this document may be interpreted or construed as an offer to sell products that is open for acceptance or the grant, conveyance or implication of any license under any copyrights, patents or other industrial or intellectual property rights.

### 9.4 Trademarks

Notice: All referenced brands, product names, service names and trademarks are the property of their respective owners.

## 10. Contact information

For additional information, please visit: <http://www.nexperia.com>

For sales office addresses, send an email to: [salesaddresses@nexperia.com](mailto:salesaddresses@nexperia.com)

## 11. Contents

---

<b>1</b>	<b>Product profile</b> . . . . .	<b>1</b>
1.1	General description . . . . .	1
1.2	Features . . . . .	1
1.3	Applications . . . . .	1
1.4	Quick reference data . . . . .	1
<b>2</b>	<b>Pinning information</b> . . . . .	<b>2</b>
<b>3</b>	<b>Ordering information</b> . . . . .	<b>2</b>
<b>4</b>	<b>Limiting values</b> . . . . .	<b>2</b>
<b>5</b>	<b>Thermal characteristics</b> . . . . .	<b>4</b>
<b>6</b>	<b>Characteristics</b> . . . . .	<b>5</b>
<b>7</b>	<b>Package outline</b> . . . . .	<b>10</b>
<b>8</b>	<b>Revision history</b> . . . . .	<b>11</b>
<b>9</b>	<b>Legal information</b> . . . . .	<b>12</b>
9.1	Data sheet status . . . . .	12
9.2	Definitions . . . . .	12
9.3	Disclaimers . . . . .	12
9.4	Trademarks . . . . .	12
<b>10</b>	<b>Contact information</b> . . . . .	<b>12</b>
<b>11</b>	<b>Contents</b> . . . . .	<b>13</b>



Компания «ЭлектроПласт» предлагает заключение долгосрочных отношений при поставках импортных электронных компонентов на взаимовыгодных условиях!

Наши преимущества:

- Оперативные поставки широкого спектра электронных компонентов отечественного и импортного производства напрямую от производителей и с крупнейших мировых складов;
- Поставка более 17-ти миллионов наименований электронных компонентов;
- Поставка сложных, дефицитных, либо снятых с производства позиций;
- Оперативные сроки поставки под заказ (от 5 рабочих дней);
- Экспресс доставка в любую точку России;
- Техническая поддержка проекта, помощь в подборе аналогов, поставка прототипов;
- Система менеджмента качества сертифицирована по Международному стандарту ISO 9001;
- Лицензия ФСБ на осуществление работ с использованием сведений, составляющих государственную тайну;
- Поставка специализированных компонентов (Xilinx, Altera, Analog Devices, Intersil, Interpoint, Microsemi, Aeroflex, Peregrine, Syfer, Eurofarad, Texas Instrument, Miteq, Cobham, E2V, MA-COM, Hittite, Mini-Circuits, General Dynamics и др.);

Помимо этого, одним из направлений компании «ЭлектроПласт» является направление «Источники питания». Мы предлагаем Вам помощь Конструкторского отдела:

- Подбор оптимального решения, техническое обоснование при выборе компонента;
- Подбор аналогов;
- Консультации по применению компонента;
- Поставка образцов и прототипов;
- Техническая поддержка проекта;
- Защита от снятия компонента с производства.



#### Как с нами связаться

**Телефон:** 8 (812) 309 58 32 (многоканальный)

**Факс:** 8 (812) 320-02-42

**Электронная почта:** [org@eplast1.ru](mailto:org@eplast1.ru)

**Адрес:** 198099, г. Санкт-Петербург, ул. Калинина, дом 2, корпус 4, литера А.