

MAX98358

PDM Input Class D Audio Power Amplifier

General Description

The MAX98358 is a digital pulse-density modulated (PDM) input Class D power amplifier that provides Class AB audio performance with Class D efficiency. This IC offers five selectable gain settings (3dB, 6dB, 9dB, 12dB, and 15dB) set by a single gain-select input (GAIN). The IC can be configured to produce a left channel, right channel, or (left/2 + right/2) output from the stereo input data.

The MAX98358 takes a stereo pulse density modulated (SPDM) input signal directly into the DAC. Data on the rising edge of PDM_CLK is considered left-channel data while data on the falling PDM_CLK edge is right channel. A mono sum feature is also implemented with SPDM data input by summing the data from both rising and falling clock edges.

Active emissions-limiting, edge-rate limiting, and overshoot control circuitry greatly reduce EMI. A filterless spread-spectrum modulation scheme eliminates the need for output filtering found in traditional Class D devices and reduces the component count of the solution.

The IC is available in 9-pin WLP (1.345mm x 1.435mm x 0.64mm) and 16-pin TQFN (3mm x 3mm x 0.75mm) packages and is specified over the -40°C to +85°C temperature range.

Applications

- Notebook and Netbook Computers
- Cellular Phones
- Tablets
- Portable Media Players

Ordering Information and **Functional Diagram** appears at end of data sheet.

Features

- Single-Supply Operation (2.5V to 5.5V)
- 3.2W Output Power into 4Ω at 5V
- 1.8mA Quiescent Current ($V_{DD} = 3.7V$)
- 92% Efficiency ($R_L = 8\Omega$, $P_{OUT} = 1.5W$)
- 29μV_{RMS} Output Noise ($A_V = 6dB$)
- Low 0.015% THD+N at 1kHz
- Supported PDM_CLK Rates of 1.84MHz–4.32MHz and 5.28MHz–8.64MHz
- Supports Left, Right, or Left/2 + Right/2 Outputs
- Sophisticated Edge Rate Control Enables Filterless Class D Outputs
- 77dB PSRR at 217Hz
- Low RF Susceptibility Rejects TDMA Noise from GSM Radios
- Extensive Click-and-Pop Reduction Circuitry
- Robust Short-Circuit and Thermal Protection
- Available in Space-Saving Packages:
 - 1.345mm x 1.435mm WLP (0.4mm Pitch)
 - 3mm x 3mm TQFN

Simplified Block Diagram

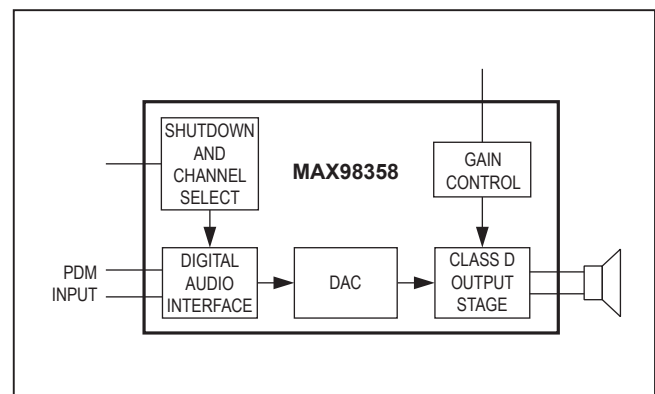

TABLE OF CONTENTS

General Description	1
Applications	1
Features	1
Simplified Block Diagram	1
Absolute Maximum Ratings	4
Package Thermal Characteristics	4
Electrical Characteristics	4
Typical Operating Characteristics	7
General	7
Speaker Amplifier	8
Bump/Pin Configurations	15
Bump/Pin Description	15
Detailed Description	16
Digital Audio Interface	16
Supported PDM_CLK Rates	16
PDM_CLK Jitter Tolerance	16
PDM Timing Characteristics	17
Standby Mode	17
SD $\overline{\text{MODE}}$ Pin and Shutdown Operation	17
Class D Speaker Amplifier	18
Ultra-Low EMI Filterless Output Stage	18
Speaker Current Limit	18
Gain Selection	18
Click-and-Pop Suppression	18
Filterless Class D Operation	22
Power-Supply Input	22
Layout and Grounding	22
WLP Applications Information	22
Functional Diagram	23
Ordering Information	23
Package Information	24
Revision History	27

LIST OF FIGURES

Figure 1. PDM Audio Interface Timing Diagram	7
Figure 2. PDM Digital Audio Interface Timing	17
Figure 3. $\overline{\text{SDMODE}}$ Resistor Connection Using Open-Drain Driver	19
Figure 4. $\overline{\text{SDMODE}}$ Resistor Connection Using Push-Pull Driver	19
Figure 5. EMI with 12in of Speaker Cable and No Output Filtering	19
Figure 6. Left-Channel Operation with 6dB Gain	20
Figure 8. Right-Channel Operation with 6dB Gain	20
Figure 7. Left-Channel Operation with 12dB Gain	20
Figure 9. Stereo Operation Using Two MAX98358s	21
Figure 10. Monomix (Left/2 + Right/2) PDM Operation with 6dB Gain	22
Figure 11. MAX98358 WLP Ball Dimensions	22

LIST OF TABLES

Table 1. PDM_CLK Channel Select	16
Table 2. PDM_CLK Rates	16
Table 3. Calculated PDM_CLK Rates	16
Table 4. RMS Jitter Tolerance	16
Table 5. $\overline{\text{SDMODE}}$ Control	17
Table 6. Examples of $\overline{\text{SDMODE}}$ Pullup Resistor Values	18
Table 7. Gain Selection	18

Absolute Maximum Ratings

V _{DD} , PDM_CLK and PDM_DATA to GND	-0.3V to +6V	Continuous Power Dissipation (T _A = +70°C)	
All Other Pins to GND	-0.3V to (V _{DD} + 0.3V)	WLP (derate 13.7mW/°C above +70°C)	1096mW
Continuous Current In/Out of V _{DD} /GND/OUT_	±1.6A	TQFN (derate 20.8mW/°C above +70°C)	1666mW
Continuous Input Current (all other pins)	±20mA	Junction Temperature	+150°C
Duration of OUT_ Short Circuit to GND or V _{DD}	Continuous	Operating Temperature Range	-40°C to +85°C
Duration of OUTP Short to OUTN	Continuous	Storage Temperature Range	-65°C to +150°C
		Soldering Temperature (reflow)	+230°C

Stresses beyond those listed under "Absolute Maximum Ratings" may cause permanent damage to the device. These are stress ratings only, and functional operation of the device at these or any other conditions beyond those indicated in the operational sections of the specifications is not implied. Exposure to absolute maximum rating conditions for extended periods may affect device reliability.

Package Thermal Characteristics (Note 1)

WLP	Junction-to-Ambient Thermal Resistance (θ _{JA})	73°C/W	TQFN	Junction-to-Ambient Thermal Resistance (θ _{JA})	48°C/W
	Junction-to-Case Thermal Resistance (θ _{JC})	50°C/W		Junction-to-Case Thermal Resistance (θ _{JC})	7°C/W

Note 1: Package thermal resistances were obtained using the method described in JEDEC specification JESD51-7, using a four-layer board. For detailed information on package thermal considerations, refer to www.maximintegrated.com/thermal-tutorial.

Electrical Characteristics

(V_{DD} = 5V, V_{GND} = 0V, GAIN = V_{DD} (+6dB), PDM_CLK = 3.072MHz, speaker loads (Z_{SPK}) connected between OUTP and OUTN, Z_{SPK} = ∞, T_A = T_{MIN} to T_{MAX}, unless otherwise noted. Typical values are at T_A = +25°C.) (Note 2)

PARAMETER	SYMBOL	CONDITIONS	MIN	TYP	MAX	UNITS
Supply Voltage Range	V _{DD}	Guaranteed by PSSR test	2.5		5.5	V
Undervoltage Lockout	UVLO		1.4	1.8	2.3	V
Quiescent Current	I _{DD}	T _A = +25°C		2.2	2.7	mA
		T _A = +25°C, V _{DD} = 3.7V		1.8	2.2	
Shutdown Current	I _{SHDN}	SD_MODE = 0V, T _A = +25°C		0.6	2	µA
Standby Current	I _{STNDBY}	SD_MODE = 1.8V, no PDM_CLK, T _A = +25°C		340	400	µA
Turn-On Time	t _{ON}	Time from receipt of first clock cycle to full operation		0.6	0.7	ms
Output Offset Voltage	V _{OS}	T _A = +25°C, gain = 15dB		±0.3	±2.5	mV
Click-and-Pop Level	K _{CP}	Peak voltage, T _A = +25°C, A-weighted, 32 samples per second (Note 3)	Into shutdown		-72	dBV
			Out of shutdown		-66	
Power-Supply Rejection Ratio	PSRR	V _{DD} = 2.5V to 5.5V, T _A = +25°C		60	75	dB
		T _A = +25°C (Notes 3, 4)	f = 217Hz, 200mV _{P-P} ripple		77	
			f = 10kHz, 200mV _{P-P} ripple		60	

Electrical Characteristics (continued)

($V_{DD} = 5V$, $V_{GND} = 0V$, $GAIN = V_{DD}$ (+6dB). $PDM_CLK = 3.072MHz$, speaker loads (Z_{SPK}) connected between $OUTP$ and $OUTN$, $Z_{SPK} = \infty$, $T_A = T_{MIN}$ to T_{MAX} , unless otherwise noted. Typical values are at $T_A = +25^{\circ}C$.) (Note 2)

PARAMETER	SYMBOL	CONDITIONS	MIN	TYP	MAX	UNITS
Output Power (Note 3)	P_{OUT}	THD+N 10%	$Z_{SPK} = 4\Omega + 33\mu H$	3.2		W
			$Z_{SPK} = 8\Omega + 68\mu H$	1.8		
			$Z_{SPK} = 8\Omega + 68\mu H$, $V_{DD} = 3.7V$	0.93		
		THD+N = 1%	$Z_{SPK} = 4\Omega + 33\mu H$	2.5		
			$Z_{SPK} = 8\Omega + 68\mu H$	1.4		
			$Z_{SPK} = 8\Omega + 68\mu H$, $V_{DD} = 3.7V$	0.77		
Total Harmonic Distortion + Noise	THD+N	$f = 1kHz$, $P_{OUT} = 1W$, $T_A = +25^{\circ}C$, $Z_{SPK} = 4\Omega + 33\mu H$ (WLP)		0.02	0.06	%
		$f = 1kHz$, $P_{OUT} = 1W$, $T_A = +25^{\circ}C$, $Z_{SPK} = 4\Omega + 33\mu H$ (TQFN)		0.02		
		$f = 1kHz$, $P_{OUT} = 0.5W$, $T_A = +25^{\circ}C$, $Z_{SPK} = 8\Omega + 68\mu H$		0.013		
Dynamic Range	DR	A-weighted, $PDM_CLK = 6.144MHz$, $V_{RMS} = 2.54V$		99		dB
Output Noise	V_N	A-weighted (Note 4)		29		μV_{RMS}
Gain (Relative to a 2.1dBV Reference Level)	A_V	GAIN = GND through 100k Ω	14.4	15	15.6	dB
		GAIN = GND	11.4	12	12.6	
		GAIN = unconnected	8.4	9	9.6	
		GAIN = V_{DD}	5.4	6	6.6	
		GAIN = V_{DD} through 100k Ω	2.4	3	3.6	
Current Limit	I_{LIM}			2.8		A
Efficiency	h	$Z_{SPK} = 8\Omega + 68\mu H$, THD+N = 10%, $f = 1kHz$, gain = 12dB		92		%
DAC Gain Error				1		%
Frequency Response				± 0.5		dB
Class D Oscillator Frequency	f_{OSC}			330		kHz
Spread-Spectrum Bandwidth				± 20		kHz
DIGITAL AUDIO INTERFACE						
PDM_CLK High Frequency Range	f_{CLKH}		5.28		8.64	MHz
PDM_CLK Low Frequency Range	f_{CLKL}		1.84		4.32	MHz
PDM_CLK High Time	t_{PDM_CLKH}		40			ns
PDM_CLK Low Time	t_{PDM_CLKL}		40			ns
Maximum Low-Frequency PDM_CLK Jitter		RMS jitter below 40kHz		0.5		ns
Maximum Low-Frequency PDM_CLK Jitter		RMS jitter above 40kHz		12		ns

Electrical Characteristics (continued)

($V_{DD} = 5V$, $V_{GND} = 0V$, GAIN = V_{DD} (+6dB). PDM_CLK = 3.072MHz, speaker loads (Z_{SPK}) connected between OUP and OUTN, $Z_{SPK} = \infty$, $T_A = T_{MIN}$ to T_{MAX} , unless otherwise noted. Typical values are at $T_A = +25^\circ C$.) (Note 2)

PARAMETER	SYMBOL	CONDITIONS	MIN	TYP	MAX	UNITS
Input High Voltage	V_{IH}	Digital audio inputs	1.3			V
Input Low Voltage	V_{IL}	Digital audio inputs			0.6	V
Input Leakage Current	I_{IH}, I_{IL}	$V_{IN} = 0V, V_{DD} = 5.5V, T_A = +25^\circ C$	-1		+1	μA
Input Capacitance	C_{IN}			3		pF
PDM Ones Density		Maximum		75		%
		Minimum		25		
PDM_DATA to PDM_CLK Setup Time	t_{SETUP}		10			ns
PDM_DATA to PDM_CLK Hold Time	t_{HOLD}		10			
SD_MODE COMPARATOR TRIP POINTS						
B0		See $\overline{SD_MODE}$ and shutdown operation for details	0.08	0.16	0.355	V
B1			0.65	0.77	0.825	
B2			1.245	1.4	1.5	
$\overline{SD_MODE}$ Pulldown Resistor	R_{PD}		92	100	108	k Ω
GAIN COMPARATOR TRIP POINTS						
	V_{GAIN}	$A_V = 3dB$ gain	0.65 x V_{DD}		0.85 x V_{DD}	V
		$A_V = 6dB$ gain	0.9 x V_{DD}		V_{DD}	
		$A_V = 9dB$ gain	0.4 x V_{DD}		0.6 x V_{DD}	
		$A_V = 12dB$ gain	0		0.1 x V_{DD}	
		$A_V = 15dB$ gain	0.15 x V_{DD}		0.35 x V_{DD}	

Note 2: 100% production tested at $T_A = +25^\circ C$. Specifications over temperature limits are guaranteed by design.

Note 3: Class D amplifier testing performed with a resistive load in series with an inductor to simulate an actual speaker load. For $R_L = 8\Omega$, $L_L = 68\mu H$. For $R_L = 4\Omega$, $L_L = 33\mu H$.

Note 4: Digital silence used for input signal.

Note 5: Dynamic range is measured using the EISA method. -60dbFS 1kHz output signal. A-weighted and normalized to 0dbFS. $f = 20Hz$ to 20kHz.

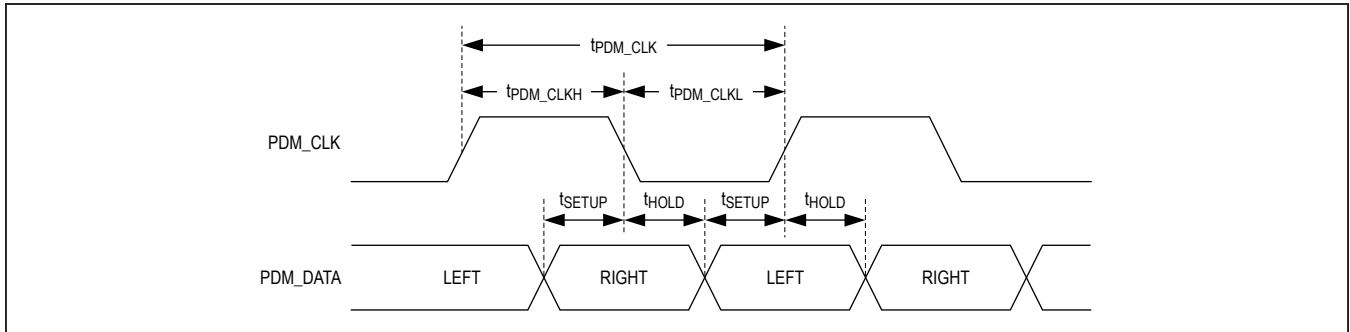
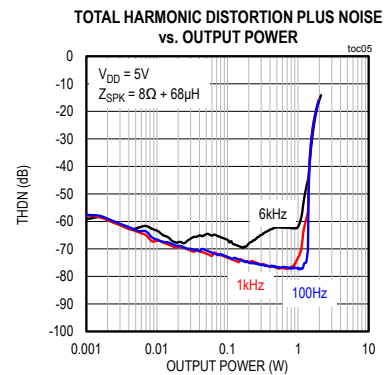
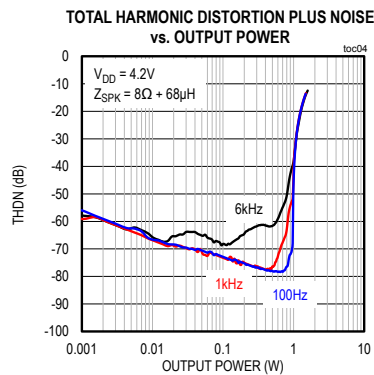
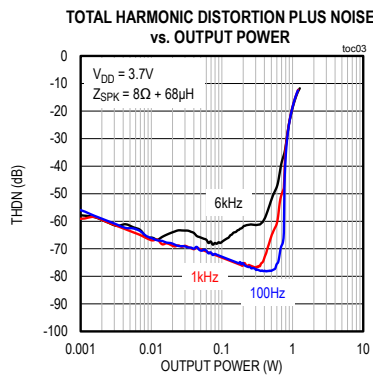
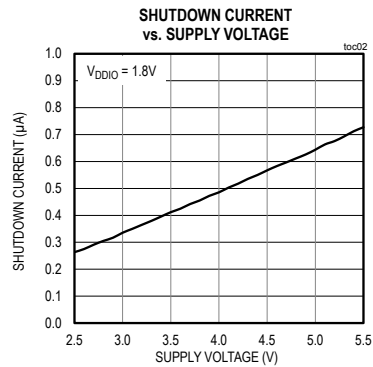
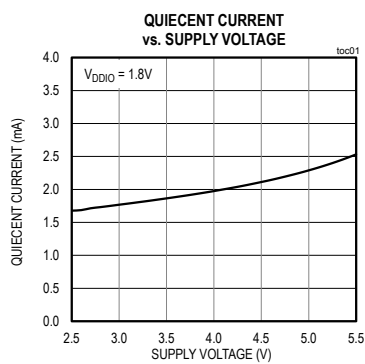

Figure 1. PDM Audio Interface Timing Diagram

Typical Operating Characteristics

($V_{DD} = 5V$, $V_{GND} = 0V$, GAIN = GND (12dB), PDM_CLK = 3.072MHz, speaker loads (Z_{SPK}) connected between OUPN and OUPN, $T_A = T_{MIN}$ to T_{MAX} , unless otherwise noted. Typical values are at $T_A = +25^{\circ}C$.)



Typical Operating Characteristics (continued)

($V_{DD} = 5V$, $V_{GND} = 0V$, GAIN = GND (12dB). PDM_CLK = 3.072MHz, speaker loads (Z_{SPK}) connected between OUTP and OUTN, $T_A = T_{MIN}$ to T_{MAX} , unless otherwise noted. Typical values are at $T_A = +25^{\circ}C$.)

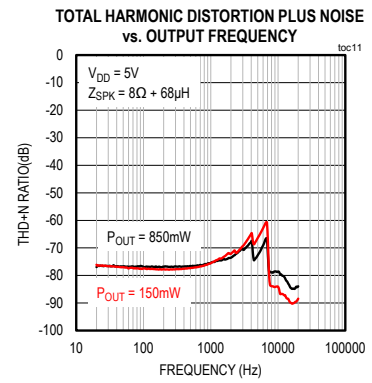
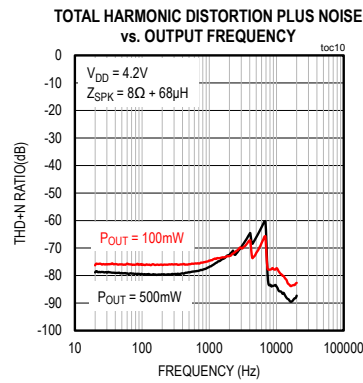
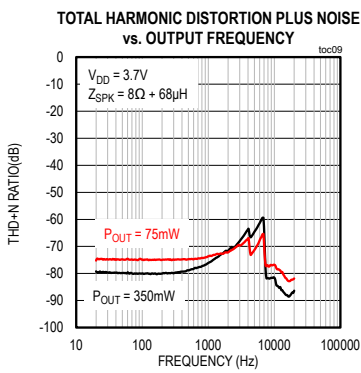
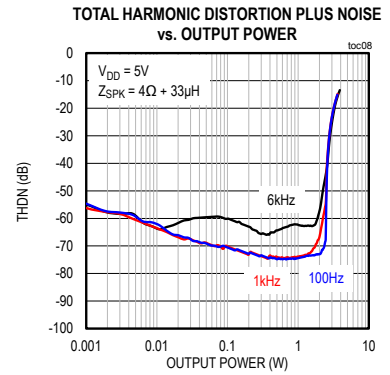
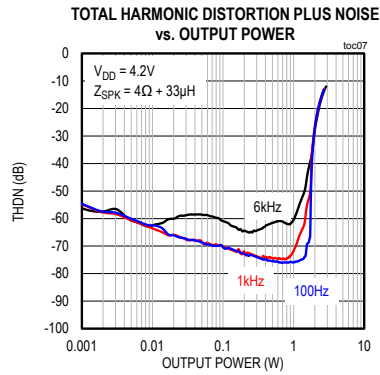
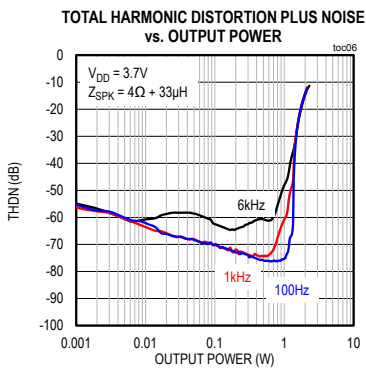

Typical Operating Characteristics (continued)

($V_{DD} = 5V$, $V_{GND} = 0V$, GAIN = GND (12dB). PDM_CLK = 3.072MHz, speaker loads (Z_{SPK}) connected between OUTP and OUTN, $T_A = T_{MIN}$ to T_{MAX} , unless otherwise noted. Typical values are at $T_A = +25^{\circ}C$.)

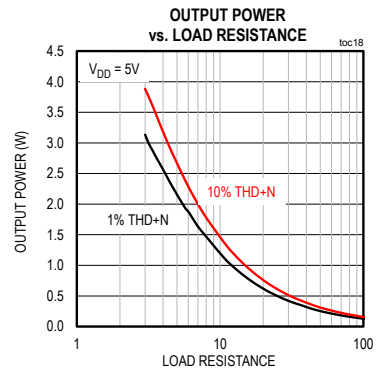
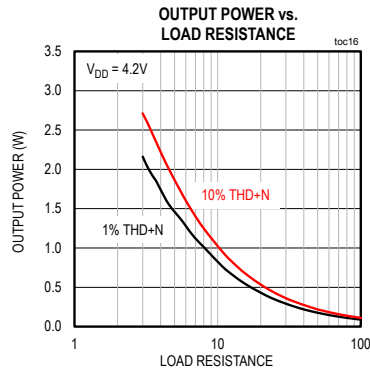
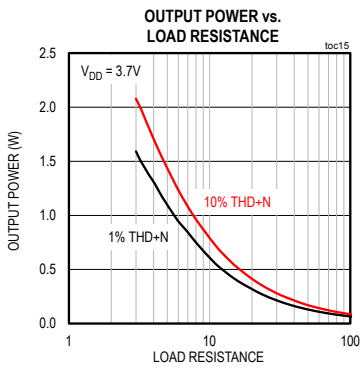
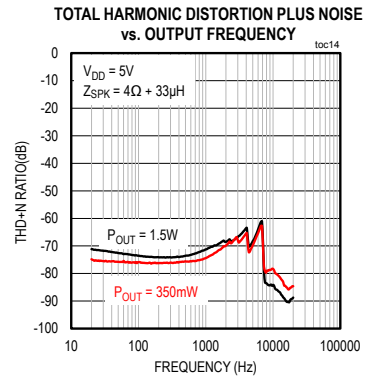
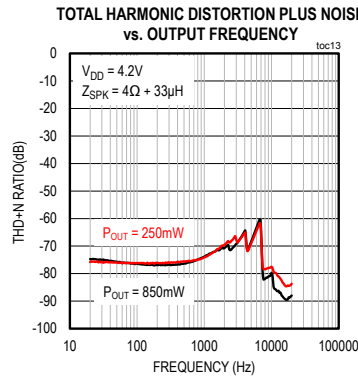
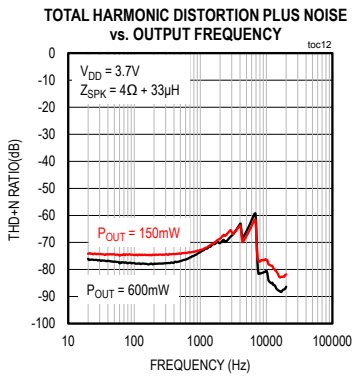

Typical Operating Characteristics (continued)

($V_{DD} = 5V$, $V_{GND} = 0V$, GAIN = GND (12dB). PDM_CLK = 3.072MHz, speaker loads (Z_{SPK}) connected between OUTP and OUTN, $T_A = T_{MIN}$ to T_{MAX} , unless otherwise noted. Typical values are at $T_A = +25^{\circ}C$.)

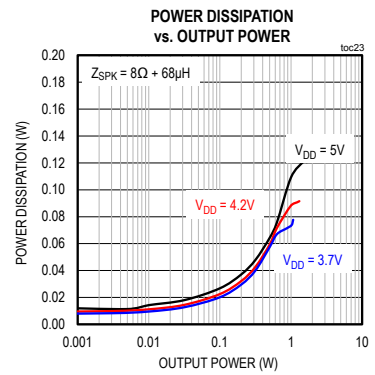
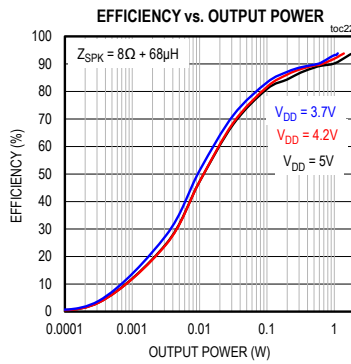
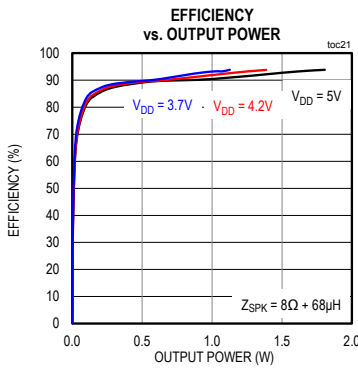
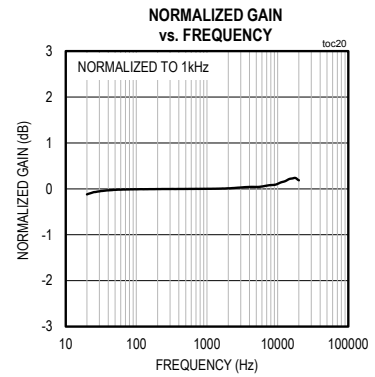
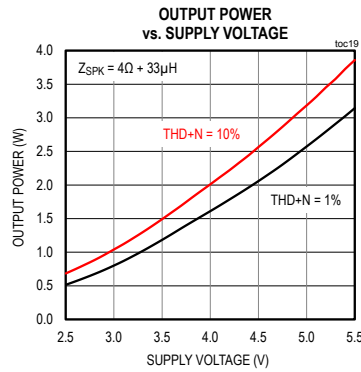
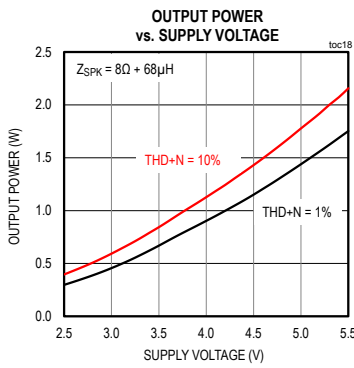

Typical Operating Characteristics (continued)

($V_{DD} = 5V$, $V_{GND} = 0V$, GAIN = GND (12dB). PDM_CLK = 3.072MHz, speaker loads (Z_{SPK}) connected between OUTP and OUTN, $T_A = T_{MIN}$ to T_{MAX} , unless otherwise noted. Typical values are at $T_A = +25^{\circ}C$.)

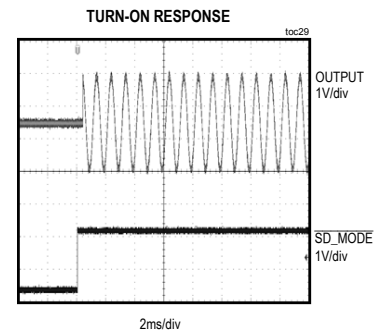
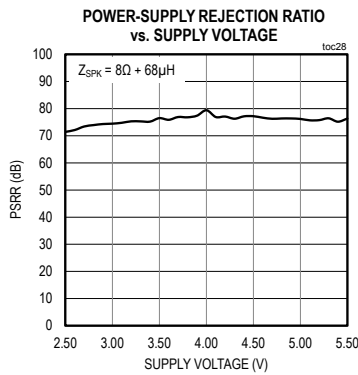
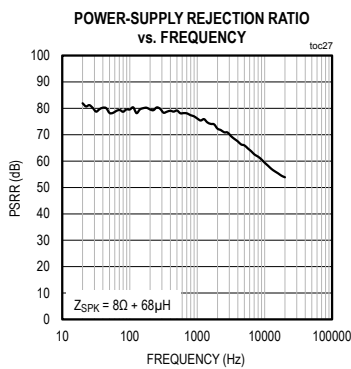
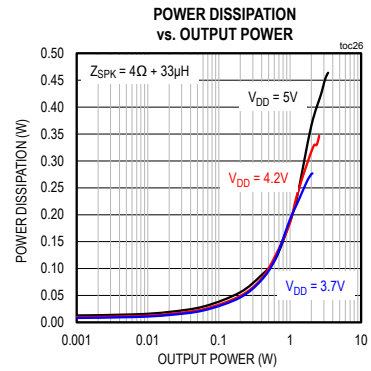
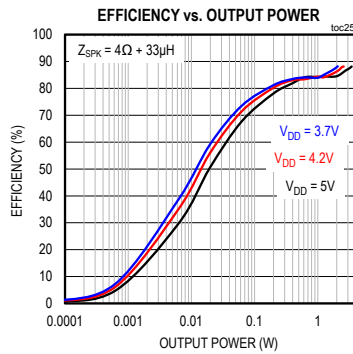
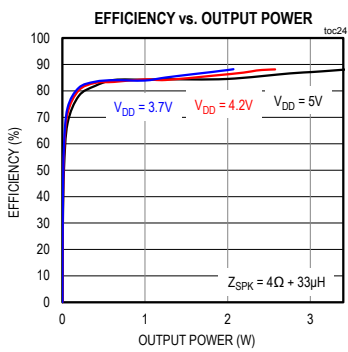

Typical Operating Characteristics (continued)

($V_{DD} = 5V$, $V_{GND} = 0V$, GAIN = GND (12dB). PDM_CLK = 3.072MHz, speaker loads (Z_{SPK}) connected between OUTP and OUTN, $T_A = T_{MIN}$ to T_{MAX} , unless otherwise noted. Typical values are at $T_A = +25^{\circ}C$.)

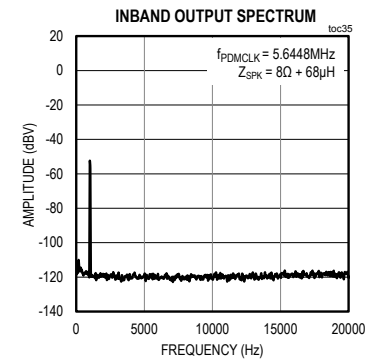
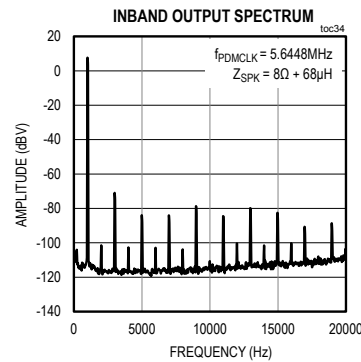
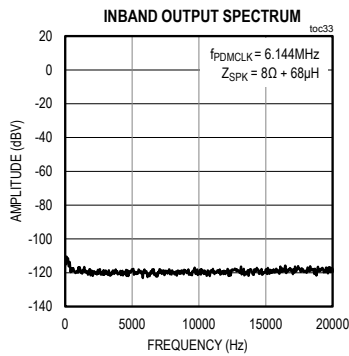
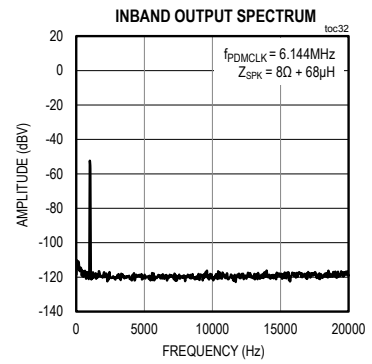
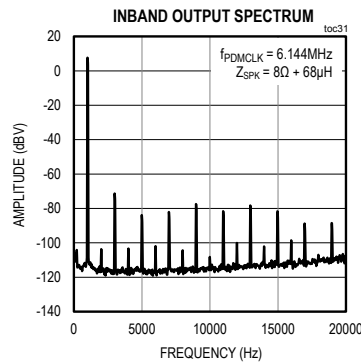
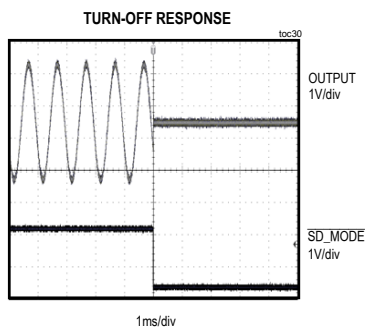

Typical Operating Characteristics (continued)

($V_{DD} = 5V$, $V_{GND} = 0V$, GAIN = GND (12dB). PDM_CLK = 3.072MHz, speaker loads (Z_{SPK}) connected between OUTP and OUTN, $T_A = T_{MIN}$ to T_{MAX} , unless otherwise noted. Typical values are at $T_A = +25^{\circ}C$.)

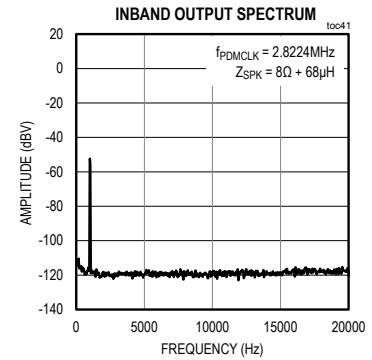
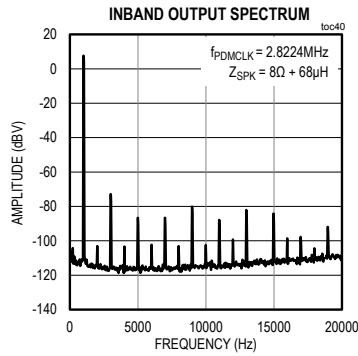
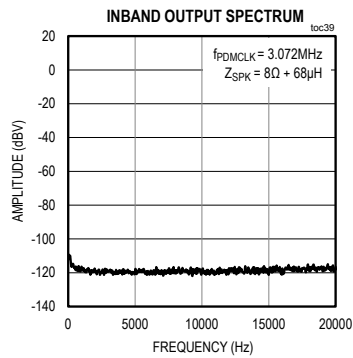
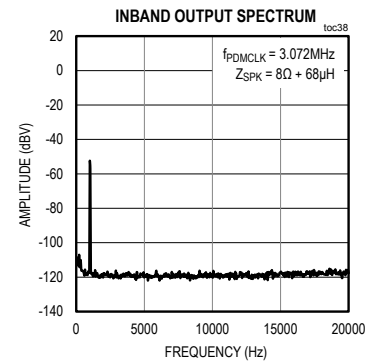
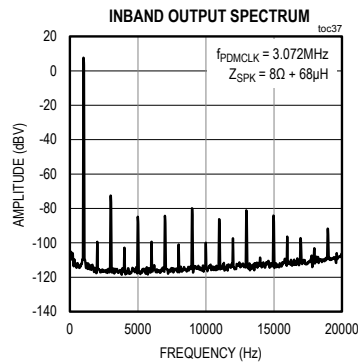
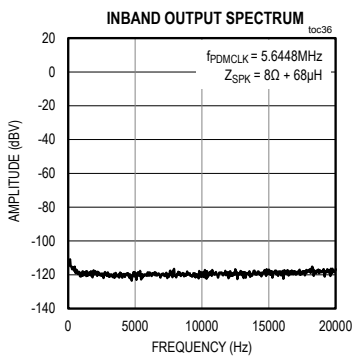

Typical Operating Characteristics (continued)

($V_{DD} = 5V$, $V_{GND} = 0V$, GAIN = GND (12dB). PDM_CLK = 3.072MHz, speaker loads (Z_{SPK}) connected between OUTP and OUTN, $T_A = T_{MIN}$ to T_{MAX} , unless otherwise noted. Typical values are at $T_A = +25^{\circ}C$.)

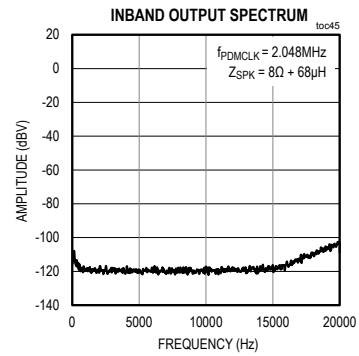
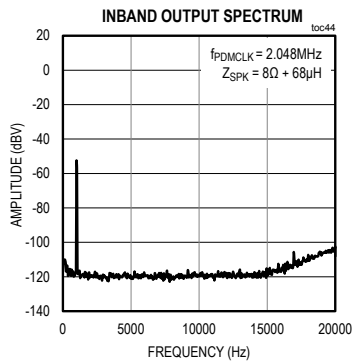
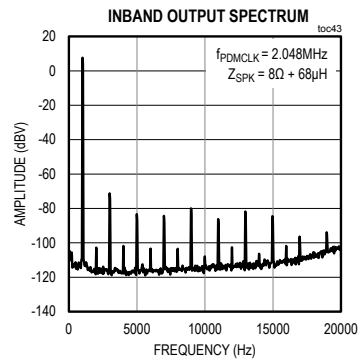
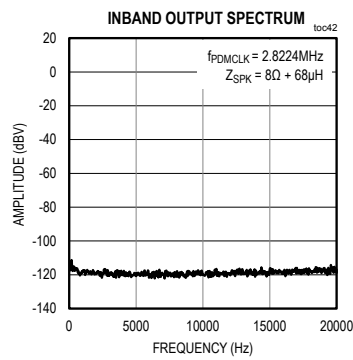

Bump/Pin Configurations

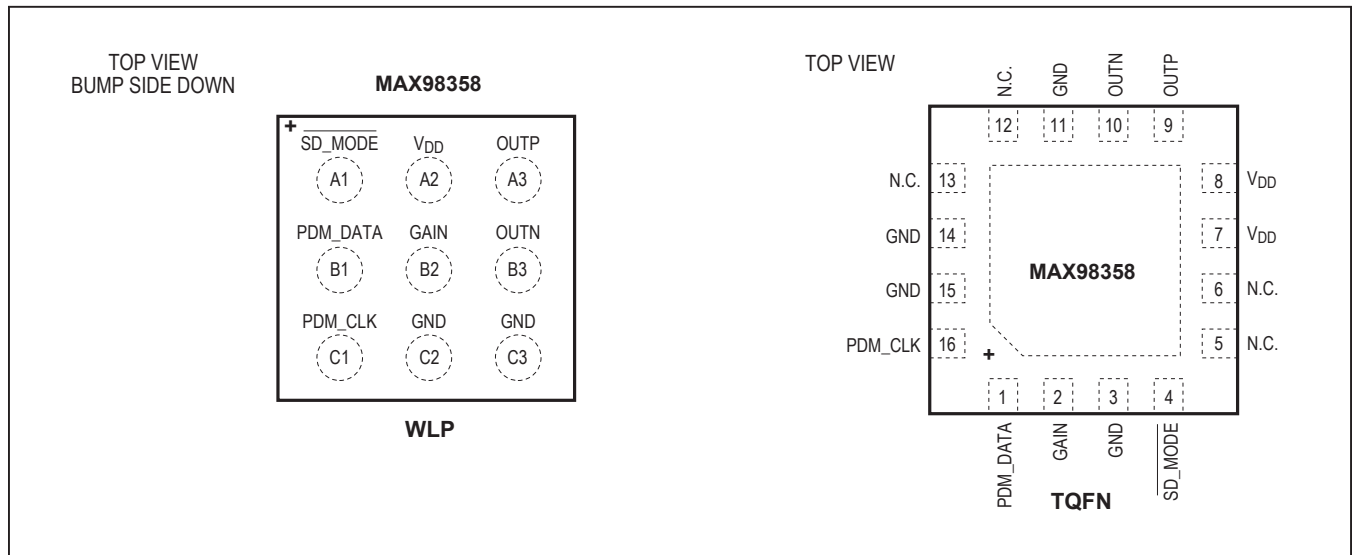

Bump/Pin Description

BUMP	PIN	NAME	FUNCTION	
WLP	TQFN			
A1	4	SD_MODE	Shutdown and Channel Select. Determines left, right, or (left/2 + right/2) mix and also used for shutdown. See Table 5.	
A2	7, 8	V _{DD}	Power-Supply Input	
A3	9	OUTP	Positive Speaker Amplifier Output	
B1	1	PDM_DATA	Digital Input Signal	
B2	2	GAIN	Amplifier Gain	
			Gain Connections	Gain (dB)
			GND through 100kΩ resistor	15
			GND	12
			Unconnected	9
			V _{DD}	6
		V _{DD} through 100kΩ resistor	3	
B3	10	OUTN	Negative Speaker Amplifier Output	
C1	16	PDM_CLK	PDM Bit Clock Input Signal. Supports frequency ranges: 1.84MHz–4.32MHz and 5.28 MHz–8.64MHz.	
C2, C3	3, 11, 14, 15	GND	Ground	
—	5, 6, 12, 13	N.C.	No Connection	
—	—	EP	Exposed Pad. The exposed pad is not internally connected. Connect the exposed pad to a solid ground plane for thermal dissipation.	

Detailed Description

The MAX98358 is a digital PDM input Class D power amplifier. The PDM modulation scheme uses the relative density of digital pulses to represent the amplitude of an analog signal. The IC accepts stereo PDM data through PDM_DATA and PDM_CLK.

SD_MODE selects which audio channel is output by the amplifier and is used to put the IC into shutdown. The GAIN pin offers five gain settings and allows the output of the amplifier to be tuned to the appropriate level.

Table 1. PDM_CLK Channel Select

PDM_CLK EDGE DIRECTION	CHANNEL
Rising edge	Left
Falling edge	Right

Table 2. PDM_CLK Rates

SUPPORTED CLOCK RATES (MHz)
1.84–4.32
5.28–8.64

Table 3. Calculated PDM_CLK Rates

BASEBAND SAMPLE RATE (kHz)	INPUT CLOCK RATES (MHz)			
	32x OVERSAMPLED PDM	64x OVERSAMPLED PDM	128x OVERSAMPLED PDM	256x OVERSAMPLED PDM
8	—	—	—	2.048
16	—	—	2.048	4.096
32	—	2.048	4.096	—
44.1	—	2.8224	5.6448*	—
48	—	3.072	6.144*	—
88.2	2.8224	5.6448*	—	—
96	3.072	6.144*	—	—

*The mono left/2 + right/2 feature is not supported at PDM_CLK rates of 5.28MHz and above.

Table 4. RMS Jitter Tolerance

FREQUENCY	RMS JITTER TOLERANCE (ns)
< 40kHz	0.5
40kHz–PDM_CLK	12

The output stage features low-quiescent current, comprehensive click-and-pop suppression, and excellent RF immunity. The IC offers Class AB audio performance with Class D efficiency in a minimal board-space solution. The Class D amplifier features spread-spectrum modulation with edge-rate and overshoot control circuitry that offers significant improvements in switch-mode amplifier radiated emissions. The amplifier features click-and-pop suppression that reduces audible transients on startup and shutdown. The amplifier includes thermal-overload and short-circuit protection.

Digital Audio Interface

The IC takes a stereo PDM input signal directly into the DAC. Data read on the rising edge of PDM_CLK is left-channel data while data read on the falling PDM_CLK edge is right channel (Table 1).

Supported PDM_CLK Rates

Table 2 indicates the range of PDM_CLK rates that are supported by the IC. Table 3 indicates the specific clock rates to use based on the baseband rate and the oversample rate of the incoming PDM signal.

PDM_CLK Jitter Tolerance

The IC features a very high PDM_CLK jitter tolerance of 0.5ns for RMS jitter below 40kHz and 12ns for wideband RMS jitter while maintaining a dynamic range greater than 98dB (Table 4).

PDM Timing Characteristics

Figure 2 shows the PDM operation of the IC. The bit depth is one bit and each bit alternates between left-channel and right-channel data.

If the PDM generator produces data that is stuck at logic-high or logic-low, then the output of the IC is railed, forcing DC at the load. Therefore, it is recommended that the PDM generator includes protection to detect this invalid condition. If such a condition is detected, then the IC should either be put into shutdown or PDM_CLK should be stopped.

Standby Mode

The MAX98358 automatically enters standby mode when PDM_CLK is removed. In standby mode, the Class D speaker amplifier is turned off and the outputs go into a high-impedance state, ensuring that the unwanted current is not transferred to the load during this condition. Standby mode should not be used in place of the shutdown mode because the shutdown mode provides the lowest power consumption and the best power-on/off click-and-pop performance.

SD_MODE Pin and Shutdown Operation

The IC features a low-power shutdown mode, drawing less than 0.6µA (typ) of supply current. During shutdown, all internal blocks are turned off, including setting the output stage to a high-impedance state. Drive SD_MODE low to put the IC into shutdown.

The state of $\overline{SD_MODE}$ determines the audio channel that is sent to the amplifier output (Table 5).

Drive $\overline{SD_MODE}$ high to select the left channel of the stereo input data. Drive $\overline{SD_MODE}$ high through a sufficiently small resistor to select the right channel of the stereo input data. Drive $\overline{SD_MODE}$ high through a sufficiently large resistor to select monomix mode where both the left and right words of the stereo input data are summed (left/2 + right/2). The monomix (left/2 + right/2) mode is not supported for PDM_CLK rates 5.28MHz. and above. RLARGE and RSMALL are determined by the VDDIO voltage (logic voltage from control interface) that is driving $\overline{SD_MODE}$ according to the following two equations:

$$R_{SMALL} \text{ (k}\Omega\text{)} = 94.0 \times V_{DDIO} - 100$$

$$R_{LARGE} \text{ (k}\Omega\text{)} = 222.2 \times V_{DDIO} - 100$$

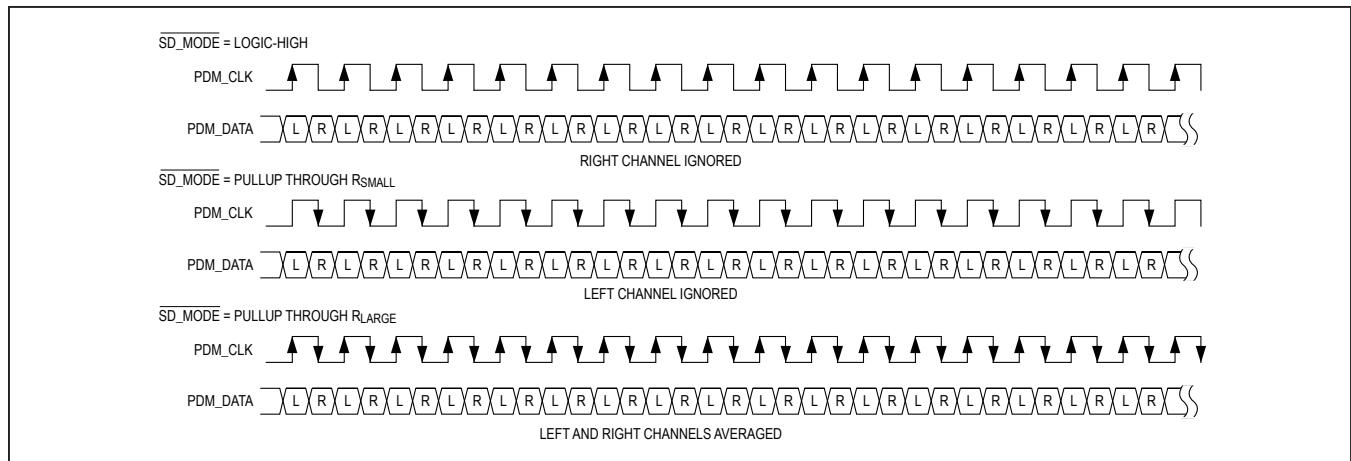

Figure 2. PDM Digital Audio Interface Timing

Table 5. $\overline{SD_MODE}$ Control

$\overline{SD_MODE}$ STATUS		SELECTED CHANNEL
High	$V_{\overline{SD_MODE}} > B2$ trip point	Left
Pullup through R_{SMALL}	$B2$ trip point (1.4V typ) $> V_{\overline{SD_MODE}} > B1$ trip point	Right
Pullup through R_{LARGE}^*	$B1$ trip point (0.77V typ) $> V_{\overline{SD_MODE}} > B0$ trip point	(Left/2 + right/2)
Low	$B0$ trip point (0.16V typ) $> V_{\overline{SD_MODE}}$	Shutdown

Figure 3 and Figure 4 show how to connect an external resistor to $\overline{\text{SD_MODE}}$ when using an open-drain driver or a pullup/down driver.

When the device is configured in left channel mode ($\overline{\text{SD_MODE}}$ is directly driven to logic-high by the control interface) care must be taken to avoid violating the Absolute Maximum Ratings limits for $\overline{\text{SD_MODE}}$. Ensuring that V_{DD} is always greater than V_{DDIO} is one way to prevent $\overline{\text{SD_MODE}}$ from violating the Absolute Maximum Ratings limits. If this is not possible in the application (e.g., if $V_{\text{DD}} < 3.0\text{V}$ and $V_{\text{DDIO}} = 3.3\text{V}$), then it is necessary to add a small resistance (~2k Ω) in series with $\overline{\text{SD_MODE}}$ to limit the current into the $\overline{\text{SD_MODE}}$ pin. This is not a concern when using the right channel or monomix modes.

Class D Speaker Amplifier

The filterless Class D amplifier offers much higher efficiency than Class AB amplifiers. The high efficiency of a Class D amplifier is due to the switching operation of the output stage transistors. Any power loss associated with the Class D output stage is mostly due to the I²R loss of the MOSFET on-resistance and quiescent current overhead.

Ultra-Low EMI Filterless Output Stage

Traditional Class D amplifiers require the use of external LC filters, or shielding, to meet EN55022B electromagnetic-interference (EMI) regulation standards. Maxim’s active emissions-limiting edge-rate control circuitry and spread-spectrum modulation reduces EMI emissions while maintaining up to 92% efficiency.

Maxim’s spread-spectrum modulation mode flattens wide-band spectral components while proprietary techniques ensure that the cycle-to-cycle variation of the switching period does not degrade audio reproduction or efficiency. The ICs’ spread-spectrum modulator randomly varies the switching frequency by $\pm 20\text{kHz}$ around the center frequency (330kHz). Above 10MHz, the wideband spectrum looks like noise for EMI purposes (Figure 5).

Speaker Current Limit

If the output current of the speaker amplifier exceeds the current limit (2.8A typ), the IC disables the outputs for approximately 100 μs . At the end of the 100 μs , the outputs are re-enabled. If the fault condition still exists, the IC continues to disable and re-enable the outputs until the fault condition is removed.

Gain Selection

The IC offers five programmable gain selections through a single gain input (GAIN). Gain is referenced to the full-scale output of the DAC, which is 2.1dBV (Table 7). Assuming that the desired output swing is not limited by the supply voltage rail, the IC’s output level can be calculated based on the PDM input one’s density and selected amplifier gain according to the following equation:

$$\text{Output signal level (dBV)} = 20 \times \log[\text{abs}(\text{PDM one's density}(\%) - 50) / 25] \text{ (dBFS)} + 2.1\text{dB} + \text{selected speaker amplifier gain (dB)}$$

where the one’s density of the PDM input ranges from 75% (maximum positive magnitude) to 25% (maximum negative magnitude). 0dBFS is referenced to 0dBV.

Click-and-Pop Suppression

The IC speaker amplifier features Maxim’s comprehensive click-and-pop suppression. During startup, the click-and-pop suppression circuitry reduces audible transient sources internal to the device. To achieve optimal click-and-pop reduction at startup, it is recommended that idle data be sent to the digital audio interface for the first 0.5ms of turn-on time. When entering shutdown, the differential speaker outputs simultaneously drop to GND.

Table 6. Examples of $\overline{\text{SD_MODE}}$ Pullup Resistor Values

LOGIC VOLTAGE LEVEL (V_{DDIO}) (V)	R _{SMALL} (k Ω)	R _{LARGE} (k Ω)
1.8	69.8	300
3.3	210	634

Table 7. Gain Selection

GAIN	GAIN (dB)
Connect to GND through 100k Ω $\pm 5\%$ resistor	15
Connect to GND	12
Unconnected	9
Connect to V_{DD}	6
Connect to V_{DD} through 100k Ω $\pm 5\%$ resistor	3

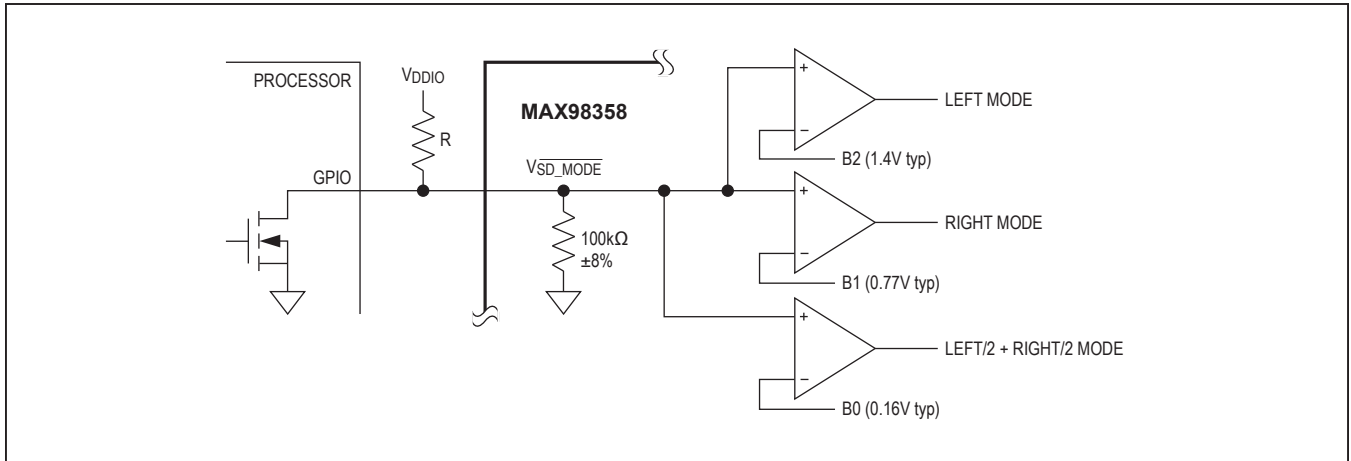

Figure 3. $\overline{SD_MODE}$ Resistor Connection Using Open-Drain Driver

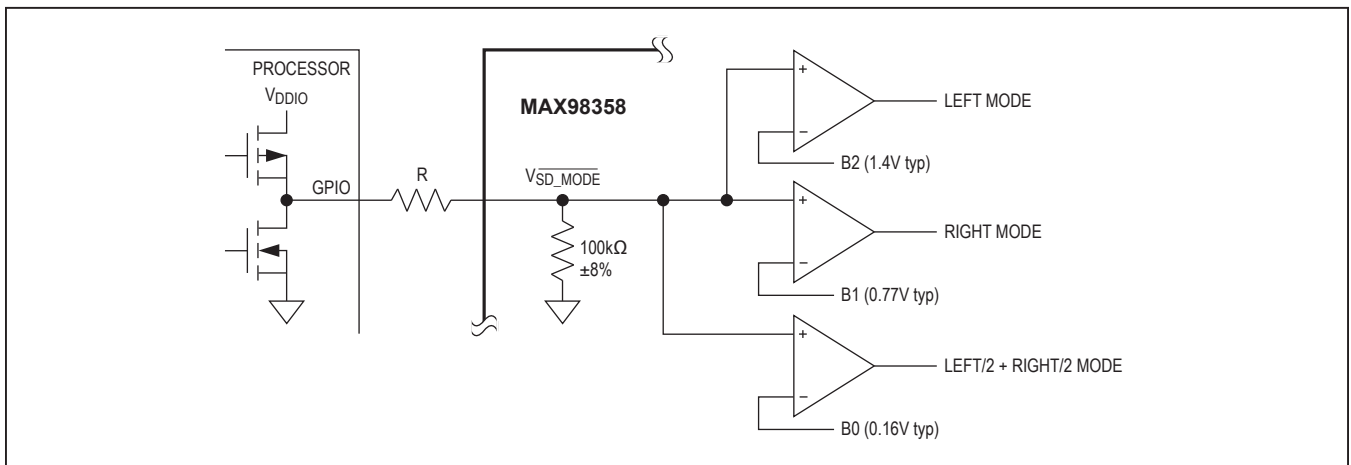

Figure 4. $\overline{SD_MODE}$ Resistor Connection Using Push-Pull Driver

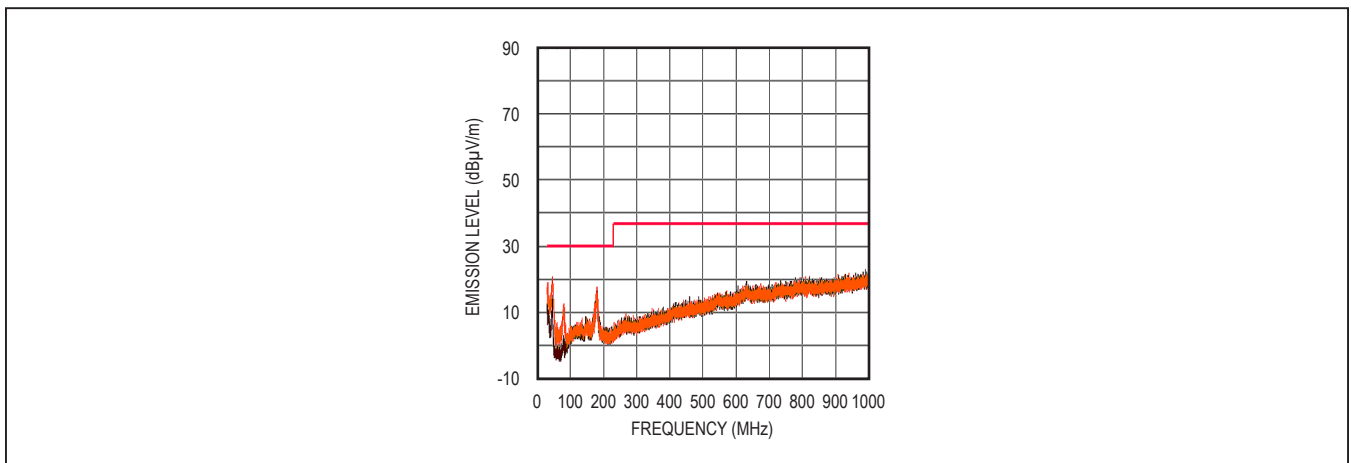

Figure 5. EMI with 12in of Speaker Cable and No Output Filtering

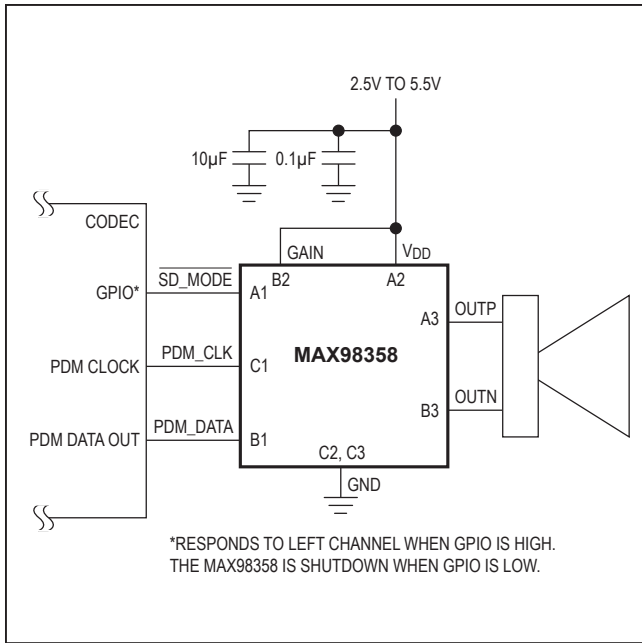

Figure 6. Left-Channel Operation with 6dB Gain

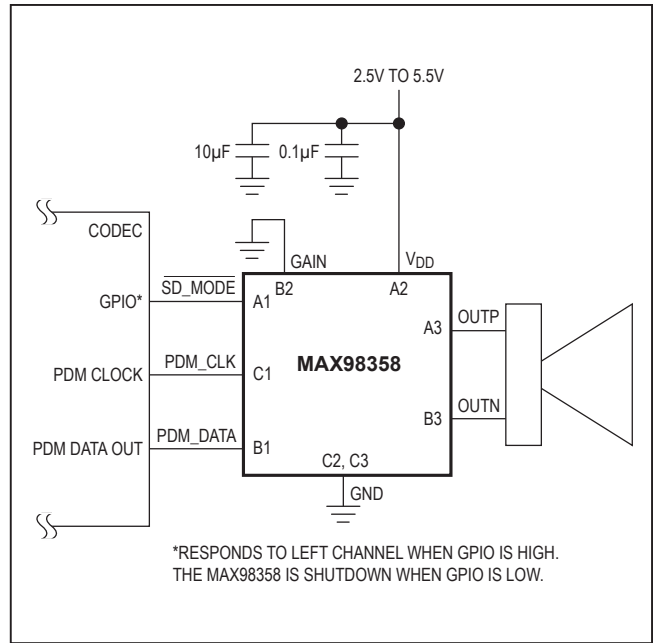

Figure 7. Left-Channel Operation with 12dB Gain

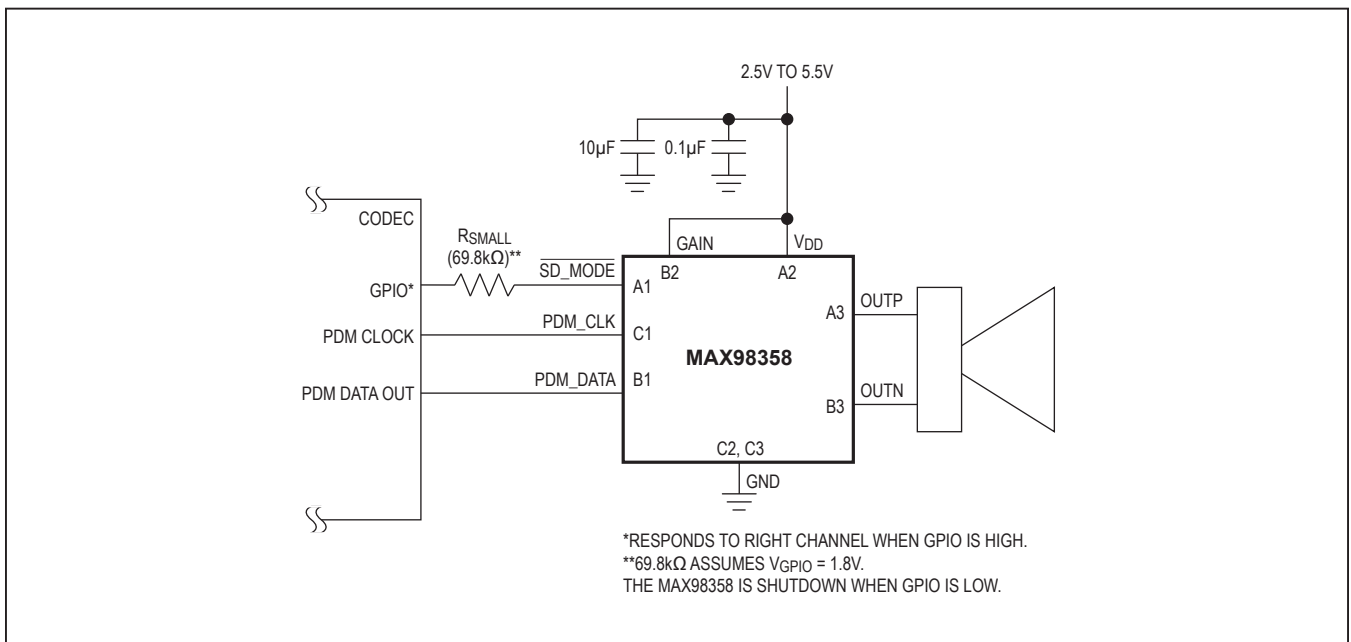

Figure 8. Right-Channel Operation with 6dB Gain

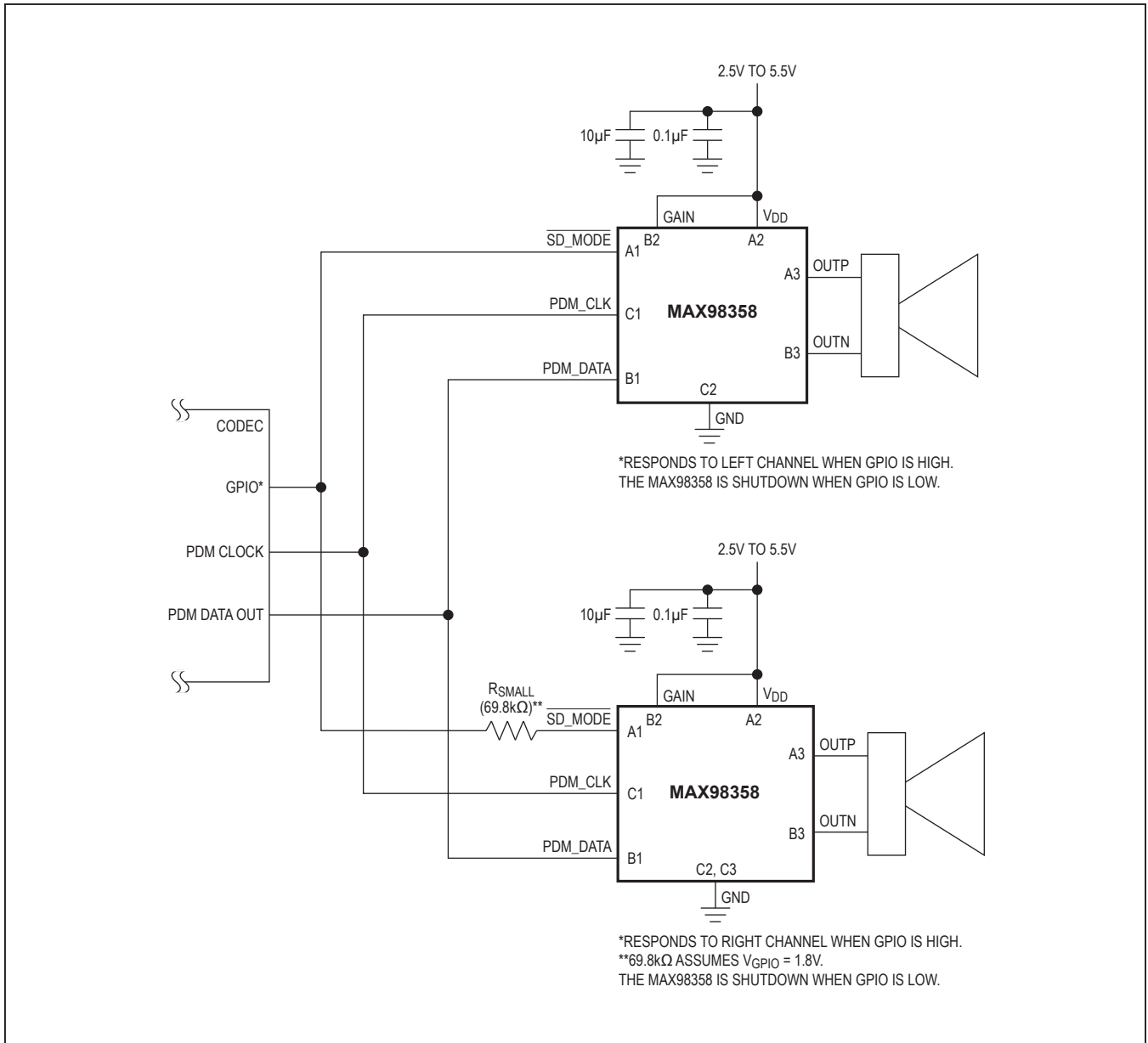

Figure 9. Stereo Operation Using Two MAX98358s

Filterless Class D Operation

Traditional Class D amplifiers require an output filter to recover the audio signal from the amplifier's output. The filter adds cost, size, and decreases efficiency and THD+N performance. The MAX98358's filterless modulation scheme does not require an output filter. The device relies on the inherent inductance of the speaker coil and the natural filtering of both the speaker and the human ear to recover the audio component of the square-wave output.

Because the switching frequency of the IC is well beyond the bandwidth of most speakers, voice coil movement due to the switching frequency is very small. Use a speaker with a series inductance > 10µH. Typical 8Ω speakers exhibit series inductances in the 20µH to 100µH range.

Power-Supply Input

V_{DD}, which ranges from 2.5V to 5.5V, powers the IC, including the speaker amplifier. Bypass V_{DD} with a 0.1µF and 10µF capacitor to GND. Some applications might require only the 10µF bypass capacitor, making it possible to operate with a single external component. Apply additional bulk capacitance at the IC if long input traces between V_{DD} and the power source are used.

Layout and Grounding

Proper layout and grounding are essential for optimum performance. Good grounding improves audio performance and prevents switching noise from coupling into the audio signal.

Use wide, low-resistance output traces. As load impedance decreases, the current drawn from the device outputs increases. At higher current, the resistance of the output traces decreases the power delivered to the load. For example, if 2W is delivered from the speaker output to a 4Ω load through 100mΩ of total speaker trace, 1.904W is being delivered to the speaker. If power is delivered through 10mΩ of total speaker trace, 1.951W is being delivered to the speaker. Wide output, supply, and ground traces also improve the power dissipation of the IC. Parasitic capacitance on the output causes higher quiescent current by $V_{DD} \times 330\text{kHz} \times C_{PARASITIC}$.

For example, at V_{DD} and a total parasitic capacitance of 100pF (50pF on each output trace), the increase in quiescent current is: $5 \times 330\text{kHz} \times 100\text{pF} = 165\mu\text{A}$.

The IC is inherently designed for excellent RF immunity. For best performance, add ground fills around all signal traces on top or bottom PCB planes.

WLP Applications Information

For the latest application details on WLP construction, dimensions, tape carrier information, PCB techniques, bump-pad layout, and recommended reflow temperature profile, as well as the latest information on reliability testing results, refer to the Application Note 1891: *Wafer-Level Packaging (WLP) and Its Applications*. Figure 11 shows the dimensions of the WLP balls used on the IC.

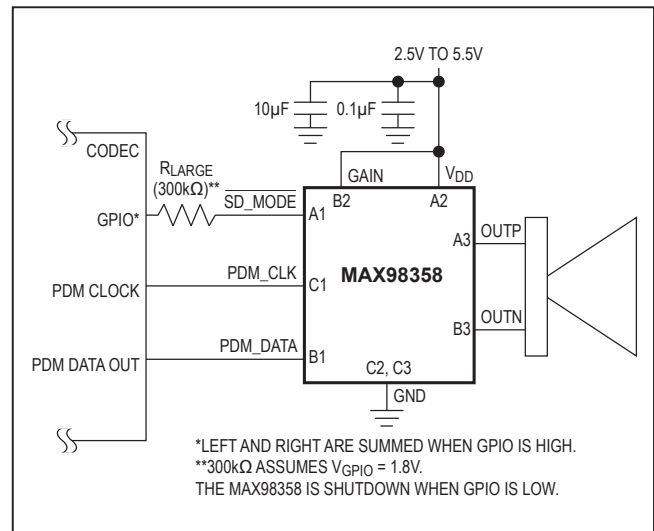

Figure 10. Monomix (Left/2 + Right/2) PDM Operation with 6dB Gain

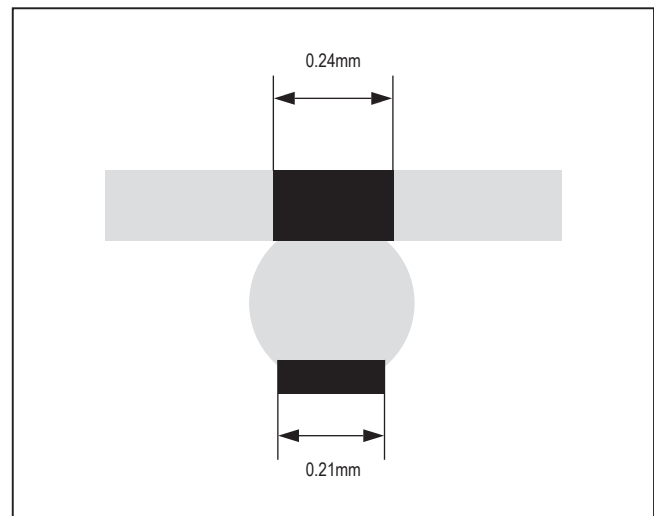
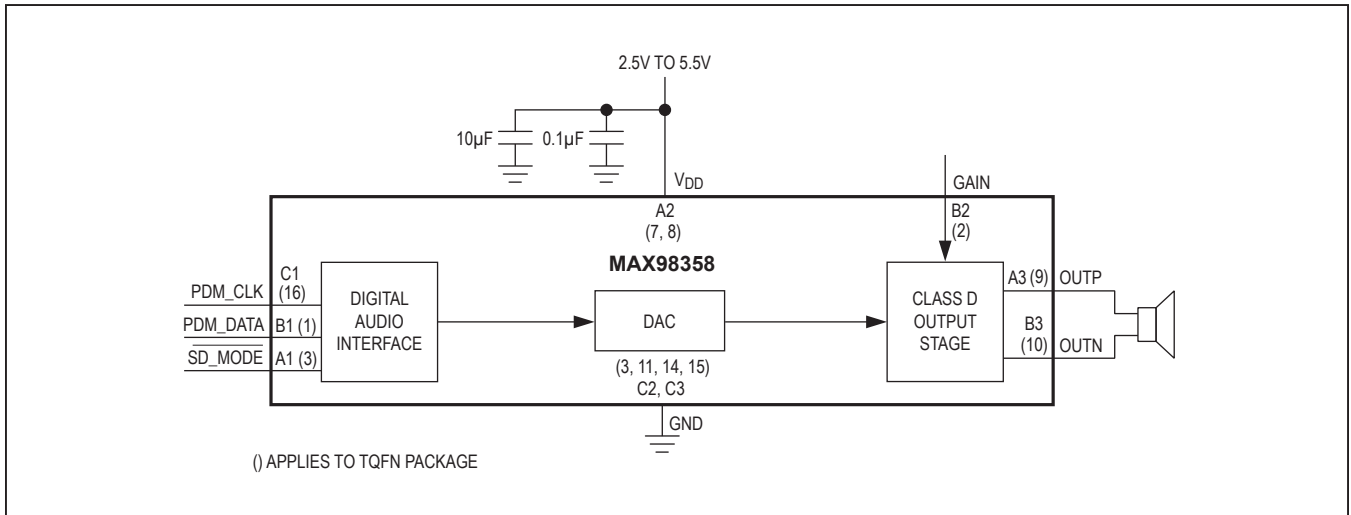

Figure 11. MAX98358 WLP Ball Dimensions

Functional Diagram



Ordering Information

PART	TEMP RANGE	PIN-PACKAGE
MAX98358EWL+T	-40°C to +85°C	9 WLP
MAX98358ETE+	-40°C to +85°C	16 TQFN

+Denotes a lead(Pb)-free/RoHS-compliant package.
 T = Tape and reel.

Package Information

For the latest package outline information and land patterns (footprints), go to www.maximintegrated.com/packages. Note that a "+", "#", or "-" in the package code indicates RoHS status only. Package drawings may show a different suffix character, but the drawing pertains to the package regardless of RoHS status.

PACKAGE TYPE	PACKAGE CODE	OUTLINE NO.	LAND PATTERN NO.
9 WLP	W91F1+1	21-0896	Refer to Application Note 1891
16 TQFN	T1633+4	21-0136	90-0031

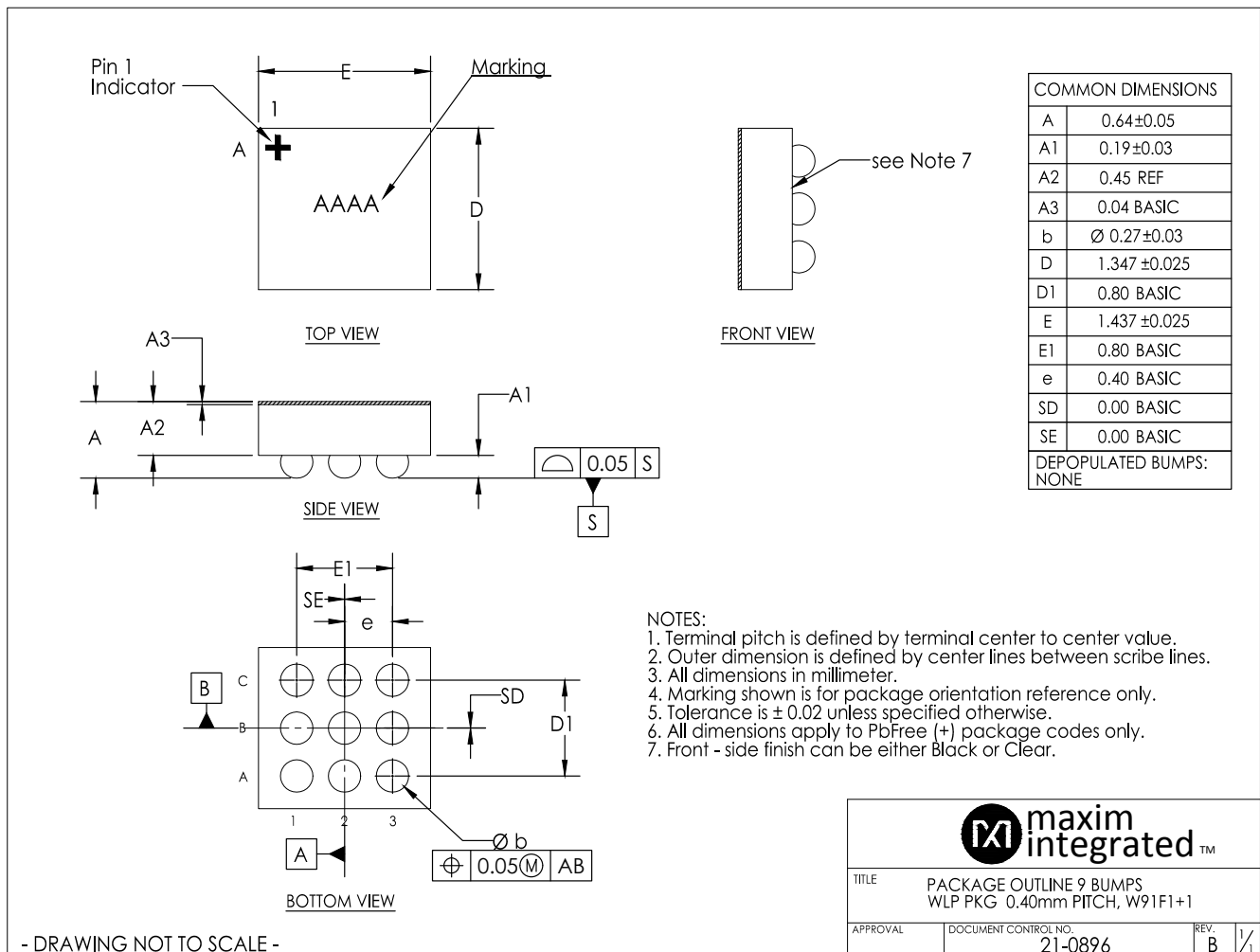

Package Information (continued)

For the latest package outline information and land patterns (footprints), go to www.maximintegrated.com/packages. Note that a "+", "#", or "-" in the package code indicates RoHS status only. Package drawings may show a different suffix character, but the drawing pertains to the package regardless of RoHS status.

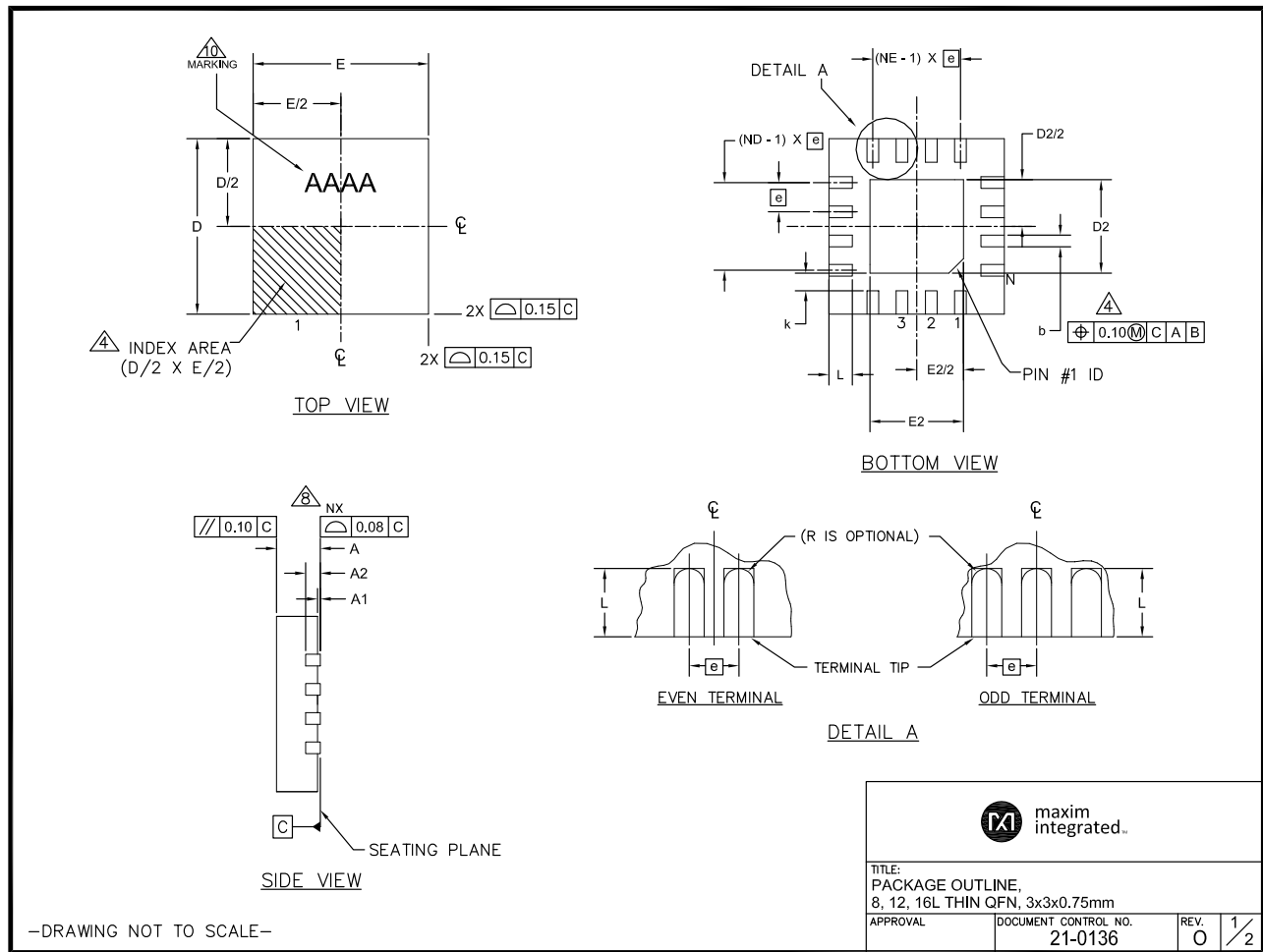

Package Information (continued)

For the latest package outline information and land patterns (footprints), go to www.maximintegrated.com/packages. Note that a "+", "#", or "-" in the package code indicates RoHS status only. Package drawings may show a different suffix character, but the drawing pertains to the package regardless of RoHS status.

PKG	8L 3x3			12L 3x3			16L 3x3		
REF.	MIN.	NOM.	MAX.	MIN.	NOM.	MAX.	MIN.	NOM.	MAX.
A	0.70	0.75	0.80	0.70	0.75	0.80	0.70	0.75	0.80
b	0.25	0.30	0.35	0.20	0.25	0.30	0.20	0.25	0.30
D	2.90	3.00	3.10	2.90	3.00	3.10	2.90	3.00	3.10
E	2.90	3.00	3.10	2.90	3.00	3.10	2.90	3.00	3.10
e	0.65 BSC.			0.50 BSC.			0.50 BSC.		
L	0.35	0.55	0.75	0.45	0.55	0.65	0.30	0.40	0.50
N	8			12			16		
ND	2			3			4		
NE	2			3			4		
A1	0	0.02	0.05	0	0.02	0.05	0	0.02	0.05
A2	0.20 REF			0.20 REF			0.20 REF		
k	0.25	-	-	0.25	-	-	0.25	-	-

EXPOSED PAD VARIATIONS								
PKG. CODES	D2			E2			PIN ID	JEDEC
	MIN.	NOM.	MAX.	MIN.	NOM.	MAX.		
TQ833-1	0.25	0.70	1.25	0.25	0.70	1.25	0.35 x 45°	WEEC
T1233-1	0.95	1.10	1.25	0.95	1.10	1.25	0.35 x 45°	WEED-1
T1233-3	0.95	1.10	1.25	0.95	1.10	1.25	0.35 x 45°	WEED-1
T1633-2	0.95	1.10	1.25	0.95	1.10	1.25	0.35 x 45°	WEED-2
T1633-2C	0.95	1.10	1.25	0.95	1.10	1.25	0.35 x 45°	WEED-2
T1633F-3	0.65	0.80	0.95	0.65	0.80	0.95	0.225 x 45°	WEED-2
T1633FH-3	0.65	0.80	0.95	0.65	0.80	0.95	0.225 x 45°	WEED-2
T1633-4	0.95	1.10	1.25	0.95	1.10	1.25	0.35 x 45°	WEED-2
T1633-4C	0.95	1.10	1.25	0.95	1.10	1.25	0.35 x 45°	WEED-2
T1633MK-5	0.95	1.10	1.25	0.95	1.10	1.25	0.35 x 45°	WEED-2

EXPOSED PAD VARIATIONS										
PKG. CODES	D2			E2			L			PIN ID
	MIN.	NOM.	MAX.	MIN.	NOM.	MAX.	MIN.	NOM.	MAX.	
T1233-4	0.95	1.10	1.25	0.95	1.10	1.25	0.35	0.45	0.55	0.35 x 45°
T1633-5	0.95	1.10	1.25	0.95	1.10	1.25	0.25	0.35	0.45	0.35 x 45°
T1633-5C	0.95	1.10	1.25	0.95	1.10	1.25	0.25	0.35	0.45	0.35 x 45°

NOTES:

- DIMENSIONING & TOLERANCING CONFORM TO ASME Y14.5M-1994.
- ALL DIMENSIONS ARE IN MILLIMETERS. ANGLES ARE IN DEGREES.
- N IS THE TOTAL NUMBER OF TERMINALS.
- THE TERMINAL #1 IDENTIFIER AND TERMINAL NUMBERING CONVENTION SHALL CONFORM TO JESD 95-1 SPP-012. DETAILS OF TERMINAL #1 IDENTIFIER ARE OPTIONAL, BUT MUST BE LOCATED WITHIN THE ZONE INDICATED. THE TERMINAL #1 IDENTIFIER MAY BE EITHER A MOLD OR MARKED FEATURE.
- DIMENSION b APPLIES TO METALLIZED TERMINAL AND IS MEASURED BETWEEN 0.20 mm AND 0.25 mm FROM TERMINAL TIP.
- ND AND NE REFER TO THE NUMBER OF TERMINALS ON EACH D AND E SIDE RESPECTIVELY.
- DEPOPULATION IS POSSIBLE IN A SYMMETRICAL FASHION.
- COPLANARITY APPLIES TO THE EXPOSED HEAT SINK SLUG AS WELL AS THE TERMINALS.
- DRAWING CONFORMS TO JEDEC MO220 REVISION C. T1233-4, T1633-5 AND T1633-5C WITH CUSTOM LEAD DIMENSION.
- MARKING SHOWN IS FOR PACKAGE ORIENTATION REFERENCE ONLY.
- NUMBER OF LEADS SHOWN ARE FOR REFERENCE ONLY.
- WARPAGE NOT TO EXCEED 0.10mm.
- ALL DIMENSIONS APPLY TO BOTH LEADED (-) AND Pb FREE (+) PARTS.

-DRAWING NOT TO SCALE-

TITLE:
PACKAGE OUTLINE,
8, 12, 16L THIN QFN, 3x3x0.75mm

APPROVAL	DOCUMENT CONTROL NO. 21-0136	REV. O	2/2
----------	---------------------------------	--------	-----

Revision History

REVISION NUMBER	REVISION DATE	DESCRIPTION	PAGES CHANGED
0	9/13	Initial release	—
1	11/13	Removed future product reference	21
2	8/14	Added THD+N TQFN typical only spec to <i>Electrical Characteristics</i> table	3
3	1/15	Added <i>Table of Contents</i> , updated SSM spec, replaced all typical operating characteristics, and corrected typos	5–12, 16–18
4	8/15	Corrected package outline for WLP package	24

For pricing, delivery, and ordering information, please contact Maxim Direct at 1-888-629-4642, or visit Maxim Integrated's website at www.maximintegrated.com.

Maxim Integrated cannot assume responsibility for use of any circuitry other than circuitry entirely embodied in a Maxim Integrated product. No circuit patent licenses are implied. Maxim Integrated reserves the right to change the circuitry and specifications without notice at any time. The parametric values (min and max limits) shown in the *Electrical Characteristics* table are guaranteed. Other parametric values quoted in this data sheet are provided for guidance.



Компания «ЭлектроПласт» предлагает заключение долгосрочных отношений при поставках импортных электронных компонентов на взаимовыгодных условиях!

Наши преимущества:

- Оперативные поставки широкого спектра электронных компонентов отечественного и импортного производства напрямую от производителей и с крупнейших мировых складов;
- Поставка более 17-ти миллионов наименований электронных компонентов;
- Поставка сложных, дефицитных, либо снятых с производства позиций;
- Оперативные сроки поставки под заказ (от 5 рабочих дней);
- Экспресс доставка в любую точку России;
- Техническая поддержка проекта, помощь в подборе аналогов, поставка прототипов;
- Система менеджмента качества сертифицирована по Международному стандарту ISO 9001;
- Лицензия ФСБ на осуществление работ с использованием сведений, составляющих государственную тайну;
- Поставка специализированных компонентов (Xilinx, Altera, Analog Devices, Intersil, Interpoint, Microsemi, Aeroflex, Peregrine, Syfer, Eurofarad, Texas Instrument, Miteq, Cobham, E2V, MA-COM, Hittite, Mini-Circuits, General Dynamics и др.);

Помимо этого, одним из направлений компании «ЭлектроПласт» является направление «Источники питания». Мы предлагаем Вам помощь Конструкторского отдела:

- Подбор оптимального решения, техническое обоснование при выборе компонента;
- Подбор аналогов;
- Консультации по применению компонента;
- Поставка образцов и прототипов;
- Техническая поддержка проекта;
- Защита от снятия компонента с производства.



Как с нами связаться

Телефон: 8 (812) 309 58 32 (многоканальный)

Факс: 8 (812) 320-02-42

Электронная почта: org@eplast1.ru

Адрес: 198099, г. Санкт-Петербург, ул. Калинина, дом 2, корпус 4, литера А.