

# FCMT099N65S3

## Power MOSFET, N-Channel, SUPERFET<sup>®</sup> III, Easy Drive, 650 V, 30 A, 99 mΩ

### Description

SUPERFET III MOSFET is ON Semiconductor's brand-new high voltage super-junction (SJ) MOSFET family that is utilizing charge balance technology for outstanding low on-resistance and lower gate charge performance. This advanced technology is tailored to minimize conduction loss, provide superior switching performance, and withstand extreme dv/dt rate. Consequently, SUPERFET III MOSFET is very suitable for the switching power applications such as server / telecom power, adaptor and solar inverter applications.

The Power88 package is an ultra-slim surface-mount package (1 mm high) with a low profile and small footprint (8x8 mm<sup>2</sup>). SUPERFET III MOSFET in a Power88 package offers excellent switching performance due to lower parasitic source inductance and separated power and drive sources. Power88 offers Moisture Sensitivity Level 1 (MSL 1).

### Features

- 700 V @ T<sub>J</sub> = 150°C
- Typ. R<sub>DS(on)</sub> = 87 mΩ
- Ultra Low Gate Charge (Typ. Q<sub>g</sub> = 56 nC)
- Low Effective Output Capacitance (Typ. C<sub>oss(eff.)</sub> = 500 pF)
- 100% Avalanche Tested
- These Devices are Pb-Free and are RoHS Compliant

### Applications

- Telecom / Server Power Supplies
- Industrial Power Supplies
- UPS / Solar



ON Semiconductor<sup>®</sup>

[www.onsemi.com](http://www.onsemi.com)

V <sub>DSS</sub>	R <sub>DS(ON)</sub> MAX	I <sub>D</sub> MAX
650 V	99 mΩ @ 10 V	30 A

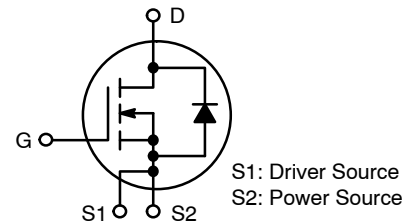

POWER MOSFET

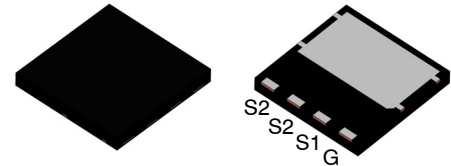

Power88  
PQFN4 8X8 2P  
CASE 483AP

### MARKING DIAGRAM

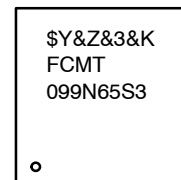

- \$Y = ON Semiconductor Logo
- &Z = Assembly Plant Code
- &3 = Data Code (Year & Week)
- &K = Lot Code
- FCMT099N65S3 = Specific Device Code

### ORDERING INFORMATION

See detailed ordering and shipping information on page 2 of this data sheet.

# FCMT099N65S3

## ABSOLUTE MAXIMUM RATINGS (T<sub>C</sub> = 25°C, Unless otherwise specified)

Symbol	Parameter	FCMT099N65S3	Unit
V <sub>DSS</sub>	Drain to Source Voltage	650	V
V <sub>GSS</sub>	Gate to Source Voltage	DC	±30
		AC (f > 1 Hz)	±30
I <sub>D</sub>	Drain Current	Continuous (T <sub>C</sub> = 25°C)	30
		Continuous (T <sub>C</sub> = 100°C)	19
I <sub>DM</sub>	Drain Current	Pulsed (Note 1)	75
E <sub>AS</sub>	Single Pulsed Avalanche Energy (Note 2)	145	mJ
I <sub>AS</sub>	Avalanche Current (Note 1)	4.4	A
E <sub>AR</sub>	Repetitive Avalanche Energy (Note 1)	2.27	mJ
dv/dt	MOSFET dv/dt	100	V/ns
	Peak Diode Recovery dv/dt (Note 3)	20	
P <sub>D</sub>	Power Dissipation	(T <sub>C</sub> = 25°C)	227
		Derate Above 25°C	1.82
T <sub>J</sub> , T <sub>STG</sub>	Operating and Storage Temperature Range	-55 to +150	°C
T <sub>L</sub>	Maximum Lead Temperature for Soldering, 1/8" from Case for 5 s	300	°C

Stresses exceeding those listed in the Maximum Ratings table may damage the device. If any of these limits are exceeded, device functionality should not be assumed, damage may occur and reliability may be affected.

1. Repetitive rating: pulse-width limited by maximum junction temperature.
2. I<sub>AS</sub> = 4.4 A, R<sub>G</sub> = 25 Ω, starting T<sub>J</sub> = 25°C.
3. I<sub>SD</sub> ≤ 15 A, di/dt ≤ 200 A/μs, V<sub>DD</sub> ≤ 400 V, starting T<sub>J</sub> = 25°C.

## THERMAL CHARACTERISTICS

Symbol	Parameter	FCMT099N65S3	Unit
R <sub>θJC</sub>	Thermal Resistance, Junction to Case, Max.	0.55	°C/W
R <sub>θJA</sub>	Thermal Resistance, Junction to Ambient, Max. (Note 4)	45	

4. Device on 1 in<sup>2</sup> pad 2 oz copper pad on 1.5 x 1.5 in. board of FR-4 material.

## PACKAGE MARKING AND ORDERING INFORMATION

Part Number	Top Marking	Package	Reel Size	Tape Width	Shipping <sup>†</sup>
FCMT099N65S3	FCMT099N65S3	Power88	13"	13.3 mm	3000 / Tape & Reel

<sup>†</sup>For information on tape and reel specifications, including part orientation and tape sizes, please refer to our Tape and Reel Packaging Specifications Brochure, BRD8011/D.

# FCMT099N65S3

## ELECTRICAL CHARACTERISTICS ( $T_C = 25^\circ\text{C}$ unless otherwise noted)

Symbol	Parameter	Test Conditions	Min	Typ	Max	Unit
--------	-----------	-----------------	-----	-----	-----	------

### OFF CHARACTERISTICS

BV <sub>DSS</sub>	Drain to Source Breakdown Voltage	V <sub>GS</sub> = 0 V, I <sub>D</sub> = 1 mA, T <sub>J</sub> = 25°C	650	-	-	V
		V <sub>GS</sub> = 0 V, I <sub>D</sub> = 1 mA, T <sub>J</sub> = 150°C	700	-	-	V
ΔBV <sub>DSS</sub> /ΔT <sub>J</sub>	Breakdown Voltage Temperature Coefficient	I <sub>D</sub> = 1 mA, Referenced to 25°C	-	0.68	-	V/°C
I <sub>DSS</sub>	Zero Gate Voltage Drain Current	V <sub>DS</sub> = 650 V, V <sub>GS</sub> = 0 V	-	-	10	μA
		V <sub>DS</sub> = 520 V, T <sub>C</sub> = 125°C	-	2.77	-	
I <sub>GSS</sub>	Gate to Body Leakage Current	V <sub>GS</sub> = ±30 V, V <sub>DS</sub> = 0 V	-	-	±100	nA

### ON CHARACTERISTICS

V <sub>GS(th)</sub>	Gate Threshold Voltage	V <sub>GS</sub> = V <sub>DS</sub> , I <sub>D</sub> = 3 mA	2.5	-	4.5	V
R <sub>DS(on)</sub>	Static Drain to Source On Resistance	V <sub>GS</sub> = 10 V, I <sub>D</sub> = 15 A	-	87	99	mΩ
g <sub>FS</sub>	Forward Transconductance	V <sub>DS</sub> = 20 V, I <sub>D</sub> = 15 A	-	17	-	S

### DYNAMIC CHARACTERISTICS

C <sub>iss</sub>	Input Capacitance	V <sub>DS</sub> = 400 V, V <sub>GS</sub> = 0 V, f = 1 MHz	-	2270	-	pF
C <sub>oss</sub>	Output Capacitance		-	50	-	pF
C <sub>oss(eff.)</sub>	Effective Output Capacitance	V <sub>DS</sub> = 0 V to 400 V, V <sub>GS</sub> = 0 V	-	500	-	pF
C <sub>oss(er.)</sub>	Energy Related Output Capacitance	V <sub>DS</sub> = 0 V to 400 V, V <sub>GS</sub> = 0 V	-	74	-	pF
Q <sub>g(tot)</sub>	Total Gate Charge at 10 V	V <sub>DS</sub> = 400 V, I <sub>D</sub> = 15 A, V <sub>GS</sub> = 10 V (Note 5)	-	56	-	nC
Q <sub>gs</sub>	Gate to Source Gate Charge		-	13	-	nC
Q <sub>gd</sub>	Gate to Drain "Miller" Charge		-	23	-	nC
ESR	Equivalent Series Resistance	f = 1 MHz	-	0.5	-	Ω

### SWITCHING CHARACTERISTICS

t <sub>d(on)</sub>	Turn-On Delay Time	V <sub>DD</sub> = 400 V, I <sub>D</sub> = 15 A, V <sub>GS</sub> = 10 V, R <sub>g</sub> = 4.7 Ω (Note 5)	-	22	-	ns
t <sub>r</sub>	Turn-On Rise Time		-	20	-	ns
t <sub>d(off)</sub>	Turn-Off Delay Time		-	58	-	ns
t <sub>f</sub>	Turn-Off Fall Time		-	5	-	ns

### SOURCE-DRAIN DIODE CHARACTERISTICS

I <sub>S</sub>	Maximum Continuous Source to Drain Diode Forward Current		-	-	30	A
I <sub>SM</sub>	Maximum Pulsed Source to Drain Diode Forward Current		-	-	75	A
V <sub>SD</sub>	Source to Drain Diode Forward Voltage	V <sub>GS</sub> = 0 V, I <sub>SD</sub> = 15 A	-	-	1.2	V
t <sub>rr</sub>	Reverse Recovery Time	V <sub>GS</sub> = 0 V, I <sub>SD</sub> = 15 A, dI <sub>F</sub> /dt = 100 A/μs	-	352	-	ns
Q <sub>rr</sub>	Reverse Recovery Charge		-	6.5	-	μC

Product parametric performance is indicated in the Electrical Characteristics for the listed test conditions, unless otherwise noted. Product performance may not be indicated by the Electrical Characteristics if operated under different conditions.

5. Essentially independent of operating temperature typical characteristics.

TYPICAL PERFORMANCE CHARACTERISTICS

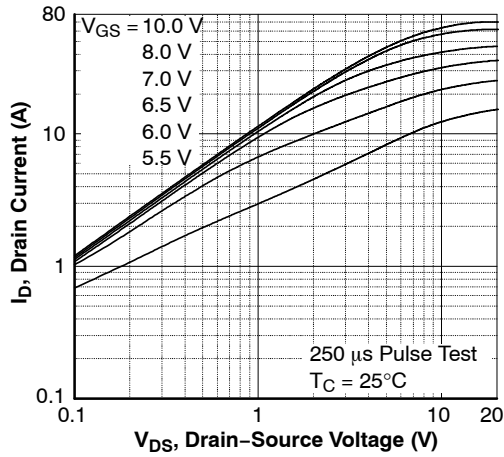

Figure 1. On-Region Characteristics

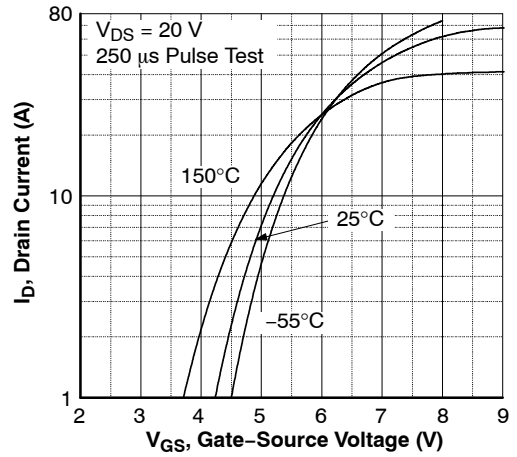

Figure 2. Transfer Characteristics

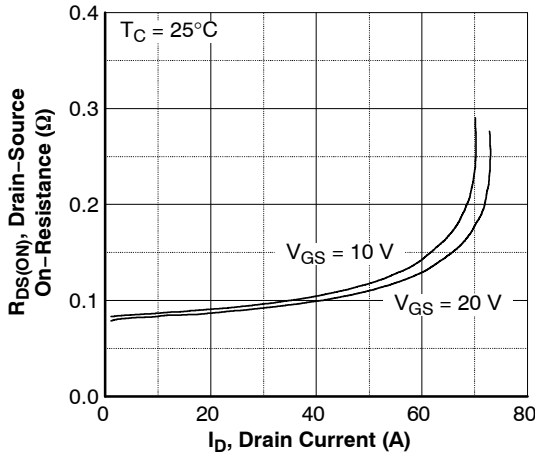

Figure 3. On-Resistance Variation vs. Drain Current and Gate Voltage

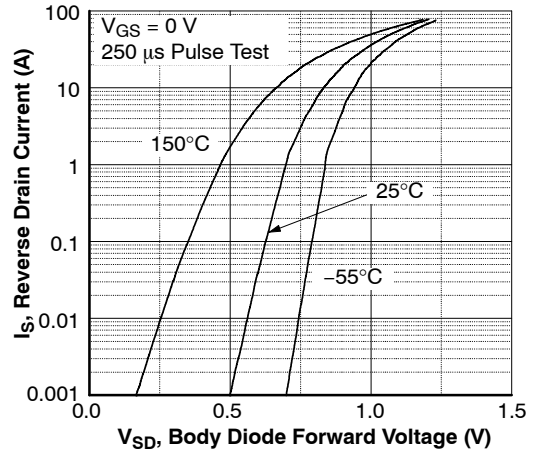

Figure 4. Body Diode Forward Voltage Variation vs. Source Current and Temperature

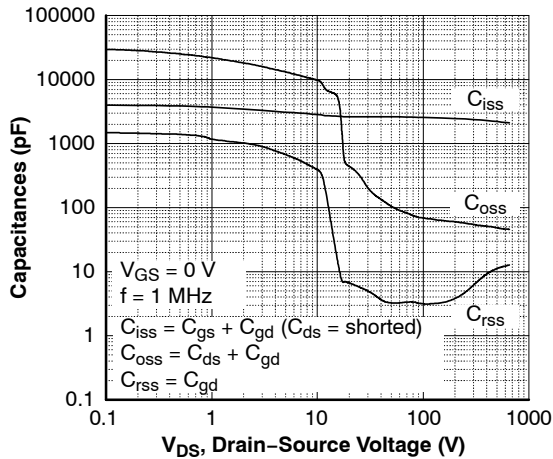

Figure 5. Capacitance Characteristics

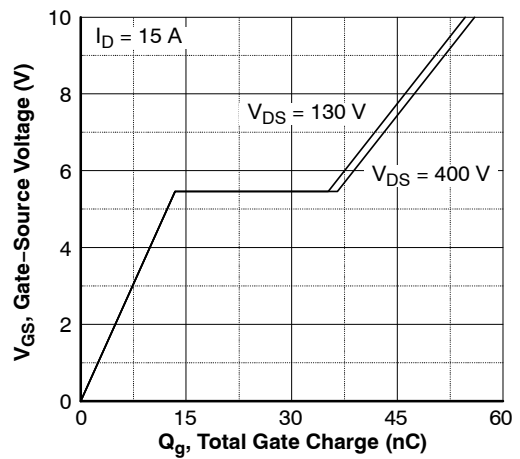

Figure 6. Gate Charge Characteristics

TYPICAL PERFORMANCE CHARACTERISTICS (Continued)

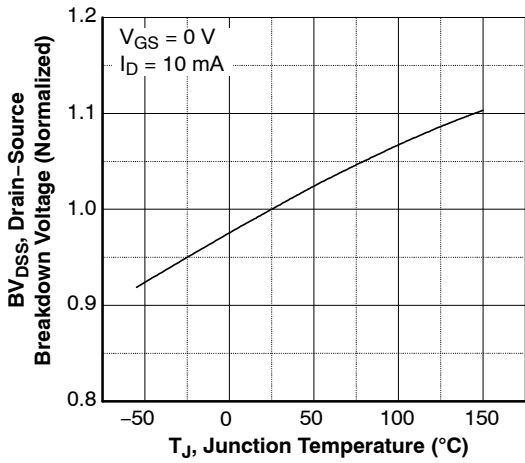

Figure 7. Breakdown Voltage Variation vs. Temperature

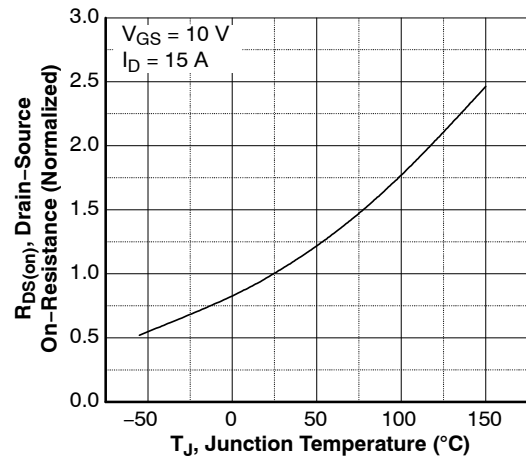

Figure 8. On-Resistance Variation vs. Temperature

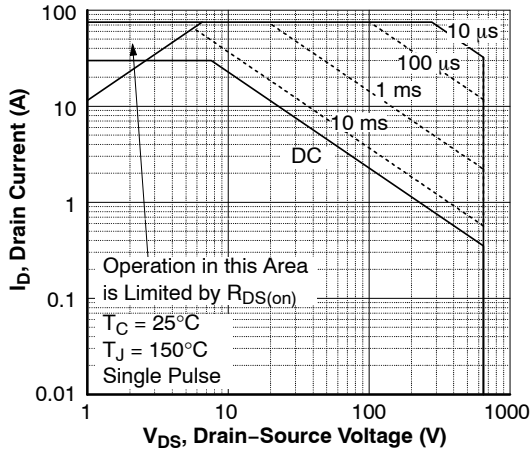

Figure 9. Maximum Safe Operating Area

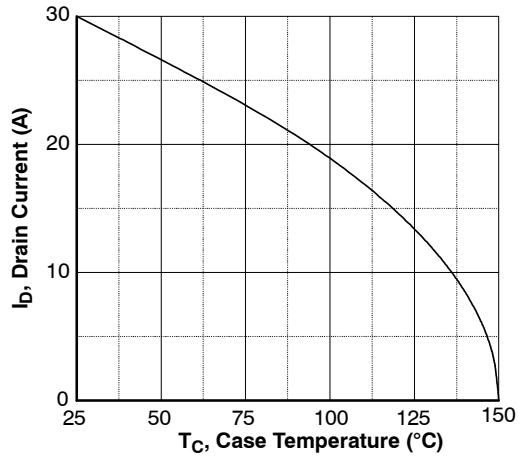

Figure 10. Maximum Drain Current vs. Case Temperature

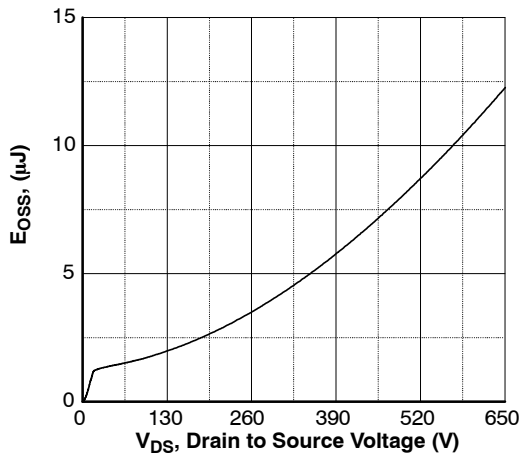

Figure 11.  $E_{OSS}$  vs. Drain to Source Voltage

TYPICAL PERFORMANCE CHARACTERISTICS (Continued)

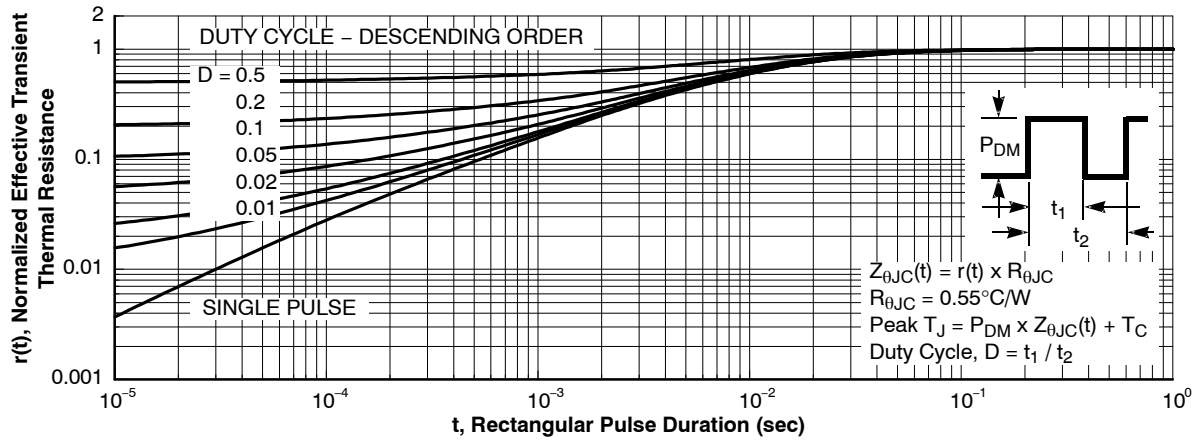

Figure 12. Transient Thermal Response Curve

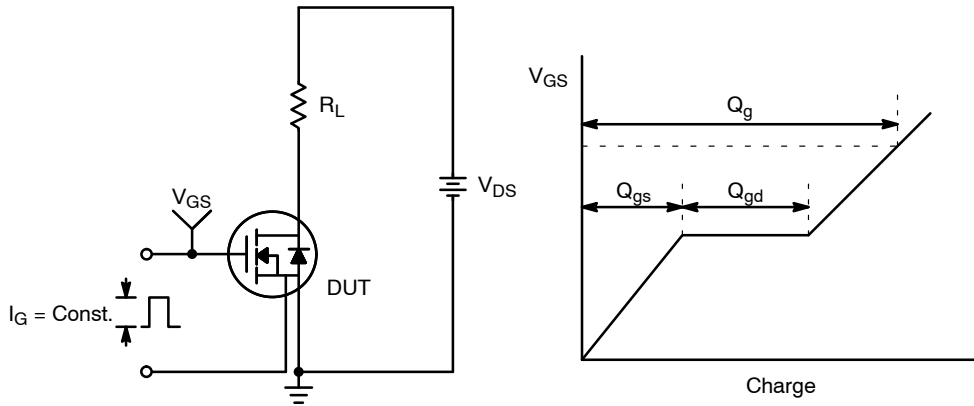

Figure 13. Gate Charge Test Circuit & Waveform

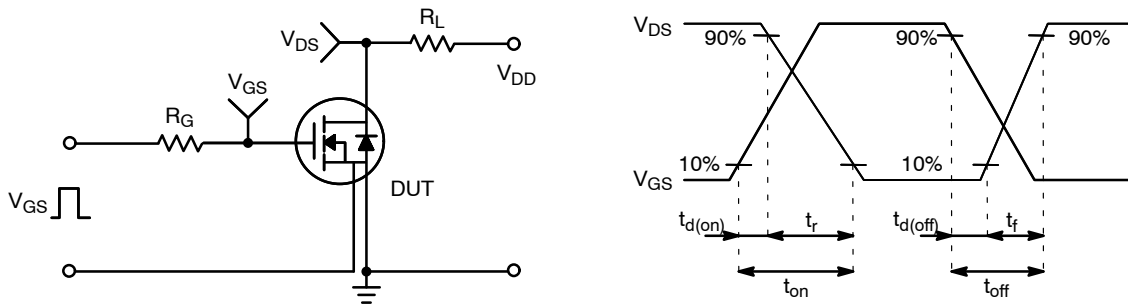

Figure 14. Resistive Switching Test Circuit & Waveforms

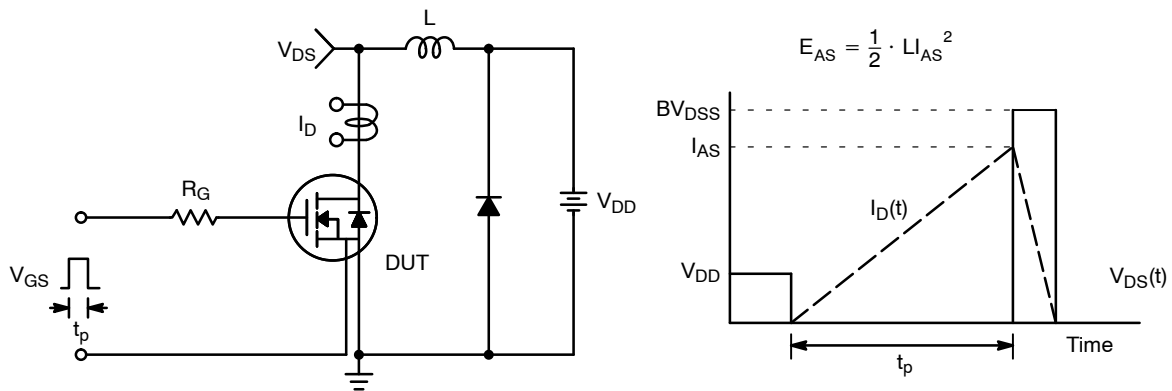
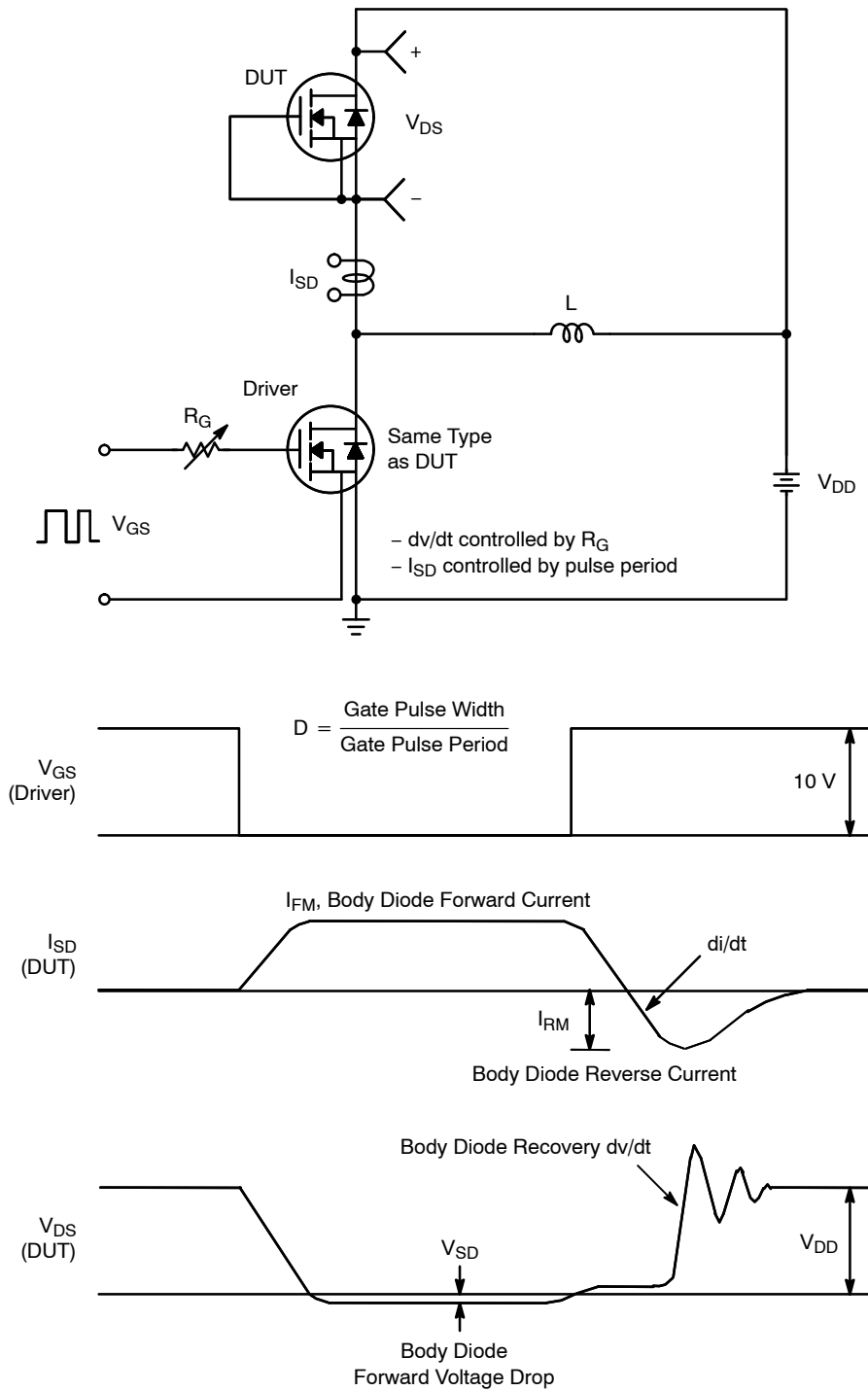

Figure 15. Unclamped Inductive Switching Test Circuit & Waveforms

# FCMT099N65S3



**Figure 16. Peak Diode Recovery  $dv/dt$  Test Circuit & Waveforms**

SUPERFET is a registered trademark of Semiconductor Components Industries, LLC (SCILLC) or its subsidiaries in the United States and/or other countries.



**MECHANICAL CASE OUTLINE**  
**PACKAGE DIMENSIONS**

ON Semiconductor®



**PQFN4 8X8, 2P**  
**CASE 483AP**  
**ISSUE O**

DATE 30 SEP 2016

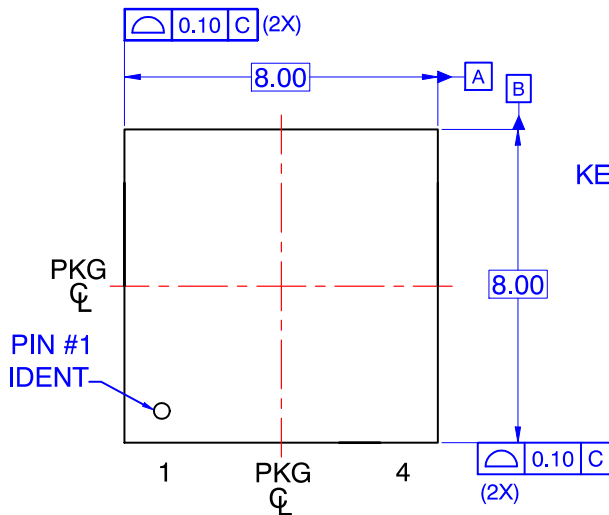

**TOP VIEW**

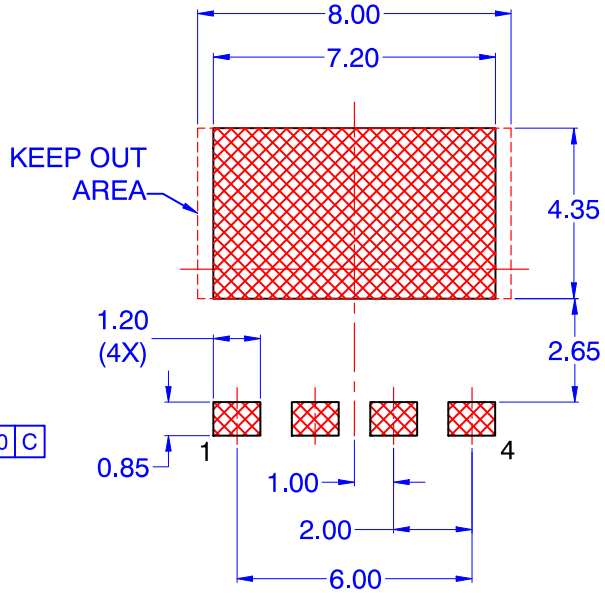

**LAND PATTERN RECOMMENDATION**

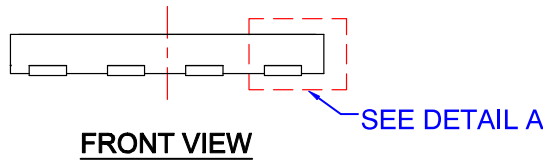

**FRONT VIEW**

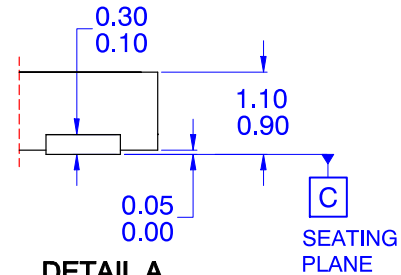

**DETAIL A**

SCALE: 2X

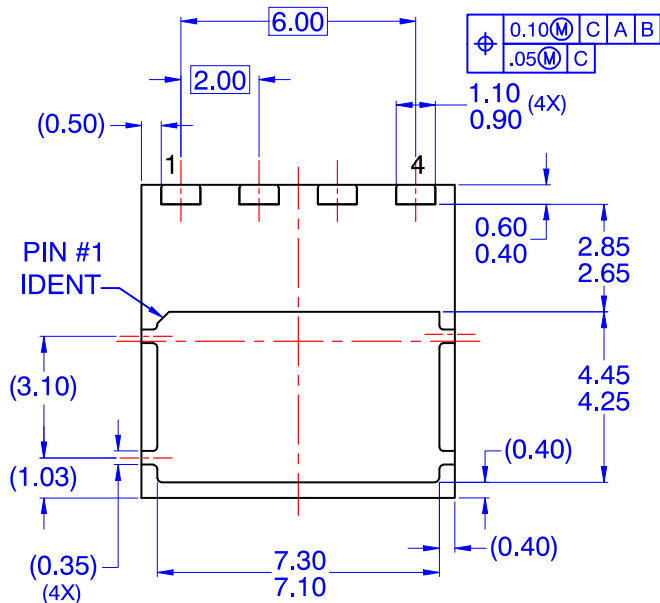

**BOTTOM VIEW**

- NOTES: UNLESS OTHERWISE SPECIFIED
- A) THIS PACKAGE IS NOT PRESENTLY REGISTERED WITH ANY STANDARDS COMMITTEE.
  - B) DIMENSIONS ARE INCLUSIVE OF BURRS, MOLD FLASH, AND TIE BAR PROTRUSIONS.
  - C) ALL DIMENSIONS ARE IN MILLIMETERS.
  - D) DRAWING CONFORMS TO ASME Y14.5M-1994.

<b>DOCUMENT NUMBER:</b>	<b>98AON13664G</b>	Electronic versions are uncontrolled except when accessed directly from the Document Repository. Printed versions are uncontrolled except when stamped "CONTROLLED COPY" in red.
<b>STATUS:</b>	<b>ON SEMICONDUCTOR STANDARD</b>	
<b>NEW STANDARD:</b>		
<b>DESCRIPTION:</b>	<b>PQFN4 8X8, 2P</b>	<b>PAGE 1 OF 2</b>



ISSUE	REVISION	DATE
O	RELEASED FOR PRODUCTION FROM FAIRCHILD PQFN04A TO ON SEMICONDUCTOR. REQ. BY I. CAMBALIZA.	30 SEP 2016

**ON Semiconductor** and are registered trademarks of Semiconductor Components Industries, LLC (SCILLC). SCILLC reserves the right to make changes without further notice to any products herein. SCILLC makes no warranty, representation or guarantee regarding the suitability of its products for any particular purpose, nor does SCILLC assume any liability arising out of the application or use of any product or circuit, and specifically disclaims any and all liability, including without limitation special, consequential or incidental damages. "Typical" parameters which may be provided in SCILLC data sheets and/or specifications can and do vary in different applications and actual performance may vary over time. All operating parameters, including "Typicals" must be validated for each customer application by customer's technical experts. SCILLC does not convey any license under its patent rights nor the rights of others. SCILLC products are not designed, intended, or authorized for use as components in systems intended for surgical implant into the body, or other applications intended to support or sustain life, or for any other application in which the failure of the SCILLC product could create a situation where personal injury or death may occur. Should Buyer purchase or use SCILLC products for any such unintended or unauthorized application, Buyer shall indemnify and hold SCILLC and its officers, employees, subsidiaries, affiliates, and distributors harmless against all claims, costs, damages, and expenses, and reasonable attorney fees arising out of, directly or indirectly, any claim of personal injury or death associated with such unintended or unauthorized use, even if such claim alleges that SCILLC was negligent regarding the design or manufacture of the part. SCILLC is an Equal Opportunity/Affirmative Action Employer. This literature is subject to all applicable copyright laws and is not for resale in any manner.

ON Semiconductor and  are trademarks of Semiconductor Components Industries, LLC dba ON Semiconductor or its subsidiaries in the United States and/or other countries. ON Semiconductor owns the rights to a number of patents, trademarks, copyrights, trade secrets, and other intellectual property. A listing of ON Semiconductor's product/patent coverage may be accessed at [www.onsemi.com/site/pdf/Patent-Marking.pdf](http://www.onsemi.com/site/pdf/Patent-Marking.pdf). ON Semiconductor reserves the right to make changes without further notice to any products herein. ON Semiconductor makes no warranty, representation or guarantee regarding the suitability of its products for any particular purpose, nor does ON Semiconductor assume any liability arising out of the application or use of any product or circuit, and specifically disclaims any and all liability, including without limitation special, consequential or incidental damages. Buyer is responsible for its products and applications using ON Semiconductor products, including compliance with all laws, regulations and safety requirements or standards, regardless of any support or applications information provided by ON Semiconductor. "Typical" parameters which may be provided in ON Semiconductor data sheets and/or specifications can and do vary in different applications and actual performance may vary over time. All operating parameters, including "Typicals" must be validated for each customer application by customer's technical experts. ON Semiconductor does not convey any license under its patent rights nor the rights of others. ON Semiconductor products are not designed, intended, or authorized for use as a critical component in life support systems or any FDA Class 3 medical devices or medical devices with a same or similar classification in a foreign jurisdiction or any devices intended for implantation in the human body. Should Buyer purchase or use ON Semiconductor products for any such unintended or unauthorized application, Buyer shall indemnify and hold ON Semiconductor and its officers, employees, subsidiaries, affiliates, and distributors harmless against all claims, costs, damages, and expenses, and reasonable attorney fees arising out of, directly or indirectly, any claim of personal injury or death associated with such unintended or unauthorized use, even if such claim alleges that ON Semiconductor was negligent regarding the design or manufacture of the part. ON Semiconductor is an Equal Opportunity/Affirmative Action Employer. This literature is subject to all applicable copyright laws and is not for resale in any manner.

## PUBLICATION ORDERING INFORMATION

### LITERATURE FULFILLMENT:

Literature Distribution Center for ON Semiconductor  
19521 E. 32nd Pkwy, Aurora, Colorado 80011 USA  
**Phone:** 303-675-2175 or 800-344-3860 Toll Free USA/Canada  
**Fax:** 303-675-2176 or 800-344-3867 Toll Free USA/Canada  
**Email:** [orderlit@onsemi.com](mailto:orderlit@onsemi.com)

**N. American Technical Support:** 800-282-9855 Toll Free  
USA/Canada  
**Europe, Middle East and Africa Technical Support:**  
Phone: 421 33 790 2910

**ON Semiconductor Website:** [www.onsemi.com](http://www.onsemi.com)

**Order Literature:** <http://www.onsemi.com/orderlit>

For additional information, please contact your local  
Sales Representative



Компания «ЭлектроПласт» предлагает заключение долгосрочных отношений при поставках импортных электронных компонентов на взаимовыгодных условиях!

Наши преимущества:

- Оперативные поставки широкого спектра электронных компонентов отечественного и импортного производства напрямую от производителей и с крупнейших мировых складов;
- Поставка более 17-ти миллионов наименований электронных компонентов;
- Поставка сложных, дефицитных, либо снятых с производства позиций;
- Оперативные сроки поставки под заказ (от 5 рабочих дней);
- Экспресс доставка в любую точку России;
- Техническая поддержка проекта, помощь в подборе аналогов, поставка прототипов;
- Система менеджмента качества сертифицирована по Международному стандарту ISO 9001;
- Лицензия ФСБ на осуществление работ с использованием сведений, составляющих государственную тайну;
- Поставка специализированных компонентов (Xilinx, Altera, Analog Devices, Intersil, Interpoint, Microsemi, Aeroflex, Peregrine, Syfer, Eurofarad, Texas Instrument, Miteq, Cobham, E2V, MA-COM, Hittite, Mini-Circuits, General Dynamics и др.);

Помимо этого, одним из направлений компании «ЭлектроПласт» является направление «Источники питания». Мы предлагаем Вам помощь Конструкторского отдела:

- Подбор оптимального решения, техническое обоснование при выборе компонента;
- Подбор аналогов;
- Консультации по применению компонента;
- Поставка образцов и прототипов;
- Техническая поддержка проекта;
- Защита от снятия компонента с производства.



#### Как с нами связаться

**Телефон:** 8 (812) 309 58 32 (многоканальный)

**Факс:** 8 (812) 320-02-42

**Электронная почта:** [org@eplast1.ru](mailto:org@eplast1.ru)

**Адрес:** 198099, г. Санкт-Петербург, ул. Калинина, дом 2, корпус 4, литера А.