



The SST12LP07 is a versatile power amplifier based on the highly-reliable InGaP/GaAs HBT technology. Easily configured for high-power applications with good power-added efficiency while operating over the 2.4- 2.5 GHz frequency band, the SST12LP07 has excellent linearity, typically ~2.5% added EVM at 19 dBm output power, while meeting 802.11g spectrum mask at 22 dBm. The SST12LP07 features easy board-level usage along with high-speed power-up/down control through a single combined reference voltage pin, and is offered in a 16-contact VQFN package.

Features

- **High Gain:**
 - Typically 29 dB gain across 2.4–2.5 GHz over temperature 0°C to +85°C
- **High linear output power:**
 - >26 dBm P1dB
 - Please refer to “Absolute Maximum Stress Ratings” on page 5
 - Meets 802.11g OFDM ACPR requirement up to 22 dBm
 - ~2.5% added EVM up to 19 dBm for 54 Mbps 802.11g signal
 - Meets 802.11b ACPR requirement up to 22 dBm
- **High power-added efficiency/Low operating current for both 802.11g/b applications**
 - ~22%/220 mA @ $P_{OUT} = 22$ dBm for 802.11g
 - ~21%/230 mA @ $P_{OUT} = 22$ dBm for 802.11b
- **Single-pin low I_{REF} power-up/down control**
 - $I_{REF} < 2$ mA
- **Low idle current**
 - ~70 mA I_{CQ}
- **High-speed power-up/down**
 - Turn on/off time (10%- 90%) <100 ns
 - Typical power-up/down delay with driver delay included <200 ns
- **High temperature stability**
 - ~1 dB gain/power variation between 0°C to +85°C
- **Low shut-down current (< 0.1 μ A)**
- **Excellent On-chip power detection**
 - <+/- 0.3dB variation between 0°C to +85°C
 - <+/- 0.4dB variation with 2:1 VSWR mismatch
 - <+/- 0.3dB variation Ch1 through Ch14
- **20 dB dynamic range on-chip power detection**
- **Simple input/output matching**
- **Packages available**
 - 16-contact VQFN – 3mm x 3mm
- **All non-Pb (lead-free) devices are RoHS compliant**

Applications

- WLAN (IEEE 802.11g/b)
- Home RF
- Cordless phones
- 2.4 GHz ISM wireless equipment



Product Description

The SST12LP07 is a versatile power amplifier based on the highly-reliable InGaP/GaAs HBT technology.

The SST12LP07 can be easily configured for high-power applications with good power-added efficiency while operating over the 2.4- 2.5 GHz frequency band. This device typically provides 29 dB gain with 22% power-added efficiency @ $P_{OUT} = 22$ dBm for 802.11g and 21% power-added efficiency @ $P_{OUT} = 22$ dBm for 802.11b.

The SST12LP07 has excellent linearity, typically ~2.5% added EVM at 19 dBm output power which is essential for 54 Mbps 802.11g/n operation while meeting 802.11g spectrum mask at 22 dBm. The SST12LP07 can also be configured for high-efficiency operation, typically 17 dBm linear 54 Mbps 802.11g output power at 85 mA total power consumption. High-efficiency operation is desirable in embedded applications such as in hand-held units.

The SST12LP07 also features easy board-level usage along with high-speed power-up/down control through a single combined reference voltage pin. Ultra-low reference current (total $I_{REF} \sim 2$ mA) makes the SST12LP07 controllable by an on/off switching signal directly from the baseband chip. These features coupled with low operating current make the SST12LP07 ideal for the final stage power amplification in battery-powered 802.11g/b WLAN transmitter applications.

The SST12LP07 has an excellent on-chip, single-ended power detector, which features wide-range (~20 dB) with dB-wise linearization and high stability over temperature (< +/-0.3 dB 0°C to +85°C), frequency (< +/-0.3 dB across Channels 1 through 14), and output load (< +/-0.4 dB with 2:1 output VSWR all phases). The excellent on-chip power detector provides a reliable solution to board-level power control.

The SST12LP07 is offered in a 16-contact VQFN package. See Figure 2 for pin assignments and Table 1 for pin descriptions.



Functional Blocks

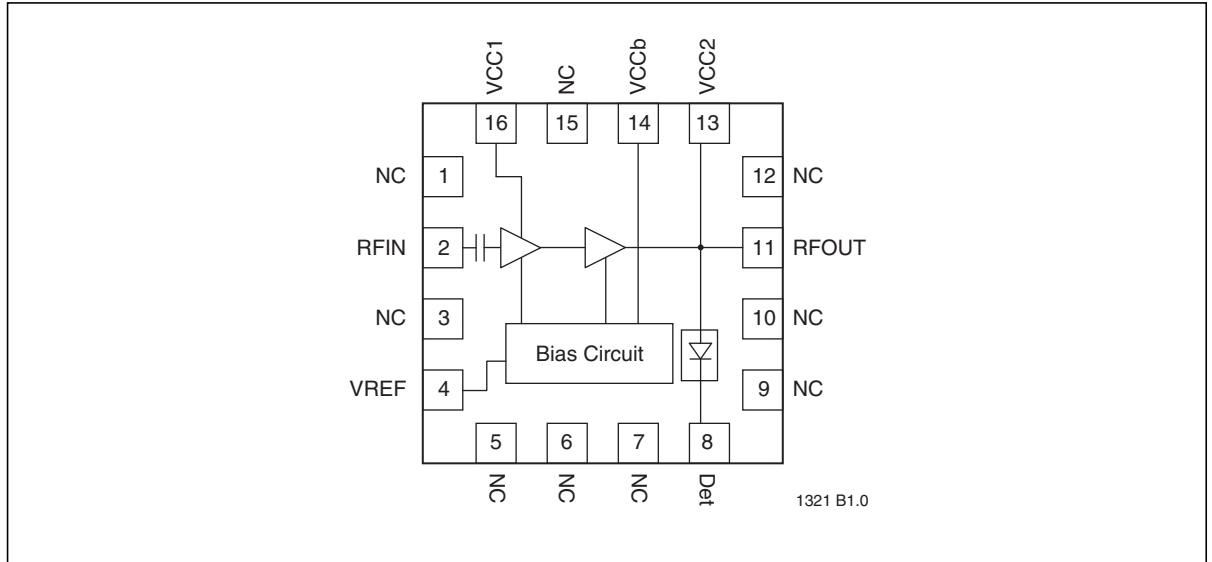

Figure 1: Functional Block Diagram



Pin Assignments

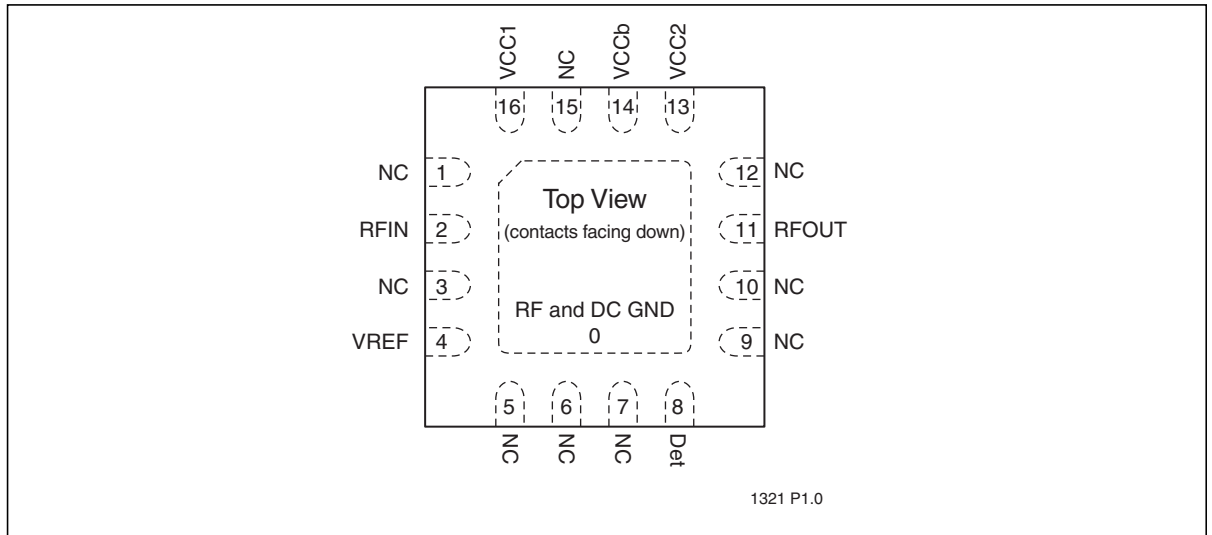

Figure 2: Pin Assignments for 16-contact VQFN

Pin Descriptions

Table 1: Pin Description

| Symbol | Pin No. | Pin Name | Type ¹ | Function |
|--------|---------|---------------|-------------------|--|
| GND | 0 | Ground | | The center pad should be connected to RF ground with several low inductance, low resistance vias |
| NC | 1 | No Connection | | Unconnected pin |
| RFIN | 2 | | I | RF input, DC decoupled |
| NC | 3 | No Connection | | Unconnected pin |
| VREF | 4 | | I | 1 st and 2 nd stage idle current control |
| NC | 5 | No Connection | | Unconnected pin |
| NC | 6 | No Connection | | Unconnected pin |
| NC | 7 | No Connection | | Unconnected pin |
| Det | 8 | | O | On-chip power detector |
| NC | 9 | No Connection | | Unconnected pin |
| NC | 10 | No Connection | | Unconnected pin |
| RFOUT | 11 | | O | RF output |
| NC | 12 | No Connection | | Unconnected pin |
| VCC2 | 13 | Power Supply | PWR | Power supply, 2 nd stage |
| VCCb | 14 | Power Supply | PWR | Power supply, bias circuit |
| NC | 15 | No Connection | | Unconnected pin |
| VCC1 | 16 | Power Supply | PWR | Power supply, 1 st stage |

1. I=Input, O=Output



2.4 GHz High-Power, High-Gain Power Amplifier

SST12LP07

Electrical Specifications

The AC and DC specifications for the power amplifier interface signals. Refer to Table 3 for the DC voltage and current specifications. Refer to Figures 3 through 11 for the RF performance.

Absolute Maximum Stress Ratings (Applied conditions greater than those listed under “Absolute Maximum Stress Ratings” may cause permanent damage to the device. This is a stress rating only and functional operation of the device at these conditions or conditions greater than those defined in the operational sections of this data sheet is not implied. Exposure to absolute maximum stress rating conditions may affect device reliability.)

| | |
|--|----------------------|
| Input power to pin 2 (P_{IN}) | +5 dBm |
| Average output power (P_{OUT}) ¹ | +26 dBm |
| Supply Voltage at pins 13, 14, and 16 (V_{CC}) | -0.3V to +4.0V |
| Reference voltage to pin 4 (V_{REF}) | -0.3V to +3.3V |
| DC supply current (I_{CC}) | 400 mA |
| Operating Temperature (T_A) | -40°C to +85°C |
| Storage Temperature (T_{STG}) | -40°C to +120°C |
| Maximum Junction Temperature (T_J) | +150°C |
| Surface Mount Solder Reflow Temperature | 260°C for 10 seconds |

1. Never measure with CW source. Pulsed single-tone source with <50% duty cycle is recommended. Exceeding the maximum rating of average output power could cause permanent damage to the device.

Table 2: Operating Range

| Range | Ambient Temp | V_{DD} |
|------------|----------------|----------|
| Industrial | -40°C to +85°C | 3.3V |

T2.1 75033

Table 3: DC Electrical Characteristics

| Symbol | Parameter | Min. | Typ | Max. | Unit | Test Conditions |
|-----------|---|----------|----------|------|------|-----------------|
| V_{CC} | Supply Voltage at pins 13, 14, 16 | 3.0 | 3.3 | 3.6 | V | |
| I_{CC} | Supply Current | | | | | |
| | for 802.11g, 22 dBm | | 220 | | mA | |
| I_{CQ} | Supply Current | | | | | |
| | for 802.11b, 22 dBm | | 230 | | mA | |
| I_{CQ} | Idle current for 802.11g to meet EVM <2.5% @ 19 dBm | | 70 | | mA | |
| I_{OFF} | Shut down current | | | 0.1 | μA | |
| V_{REG} | Reference Voltage for, with 110Ω resistor | 2.7 5 | 2.8 5 | 2.95 | V | |

T3.0 75033



2.4 GHz High-Power, High-Gain Power Amplifier

SST12LP07

Data Sheet

Table 4: AC Electrical Characteristics for Configuration

| Symbol | Parameter | Min. | Typ | Max. | Unit |
|-------------------|---|------|-----|------|------|
| F _{L-U} | Frequency range | 2400 | | 2485 | MHz |
| P _{OUT} | Output power | | | | |
| | @ PIN = -6 dBm 11b signals | 22 | | | dBm |
| | @ PIN = -7 dBm 11g signals | 21 | | | dBm |
| G | Small signal gain | 28 | 29 | | dB |
| G _{VAR1} | Gain variation over band (2400~2485 MHz) | | | ±0.5 | dB |
| G _{VAR2} | Gain ripple over channel (20 MHz) | | 0.2 | | dB |
| ACPR | Meet 11b spectrum mask | 22 | | | dBm |
| | Meet 11g OFDM 54 Mbps spectrum mask | 22 | | | dBm |
| Added EVM | @ 19 dBm output with 11g OFDM 54 Mbps signal | | 2.5 | | % |
| 2f, 3f, 4f, 5f | Harmonics at 22 dBm, without external filters | | -40 | | dBc |

T4.2 75033



Typical Performance Characteristics

Test Conditions: $V_{CC} = 3.3V$, $T_A = 25^\circ C$, unless otherwise specified

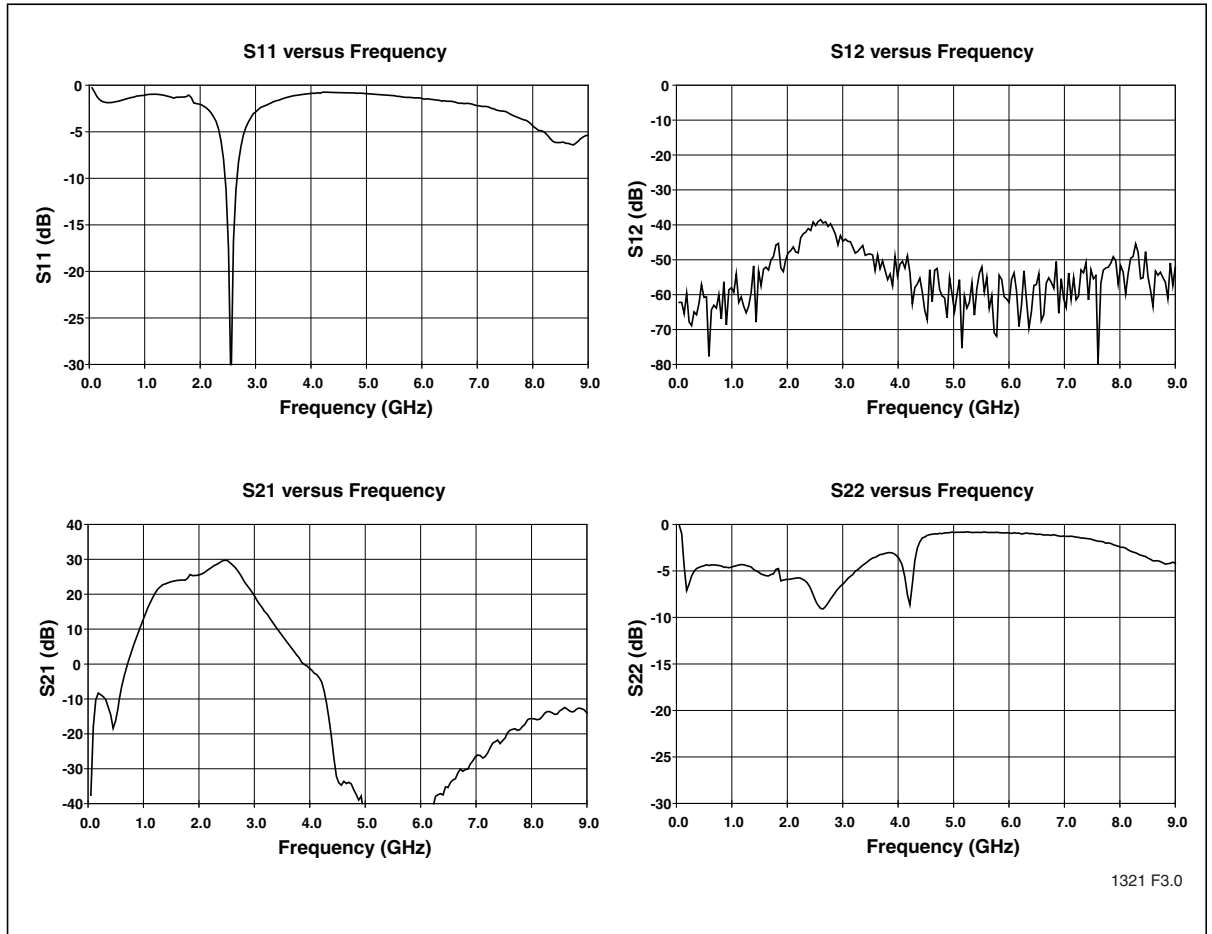

Figure 3: S-Parameters



Typical Performance Characteristics

Test Conditions: $V_{CC} = 3.3V$, $T_A = 25^\circ C$, 54 Mbps 802.11g OFDM signal

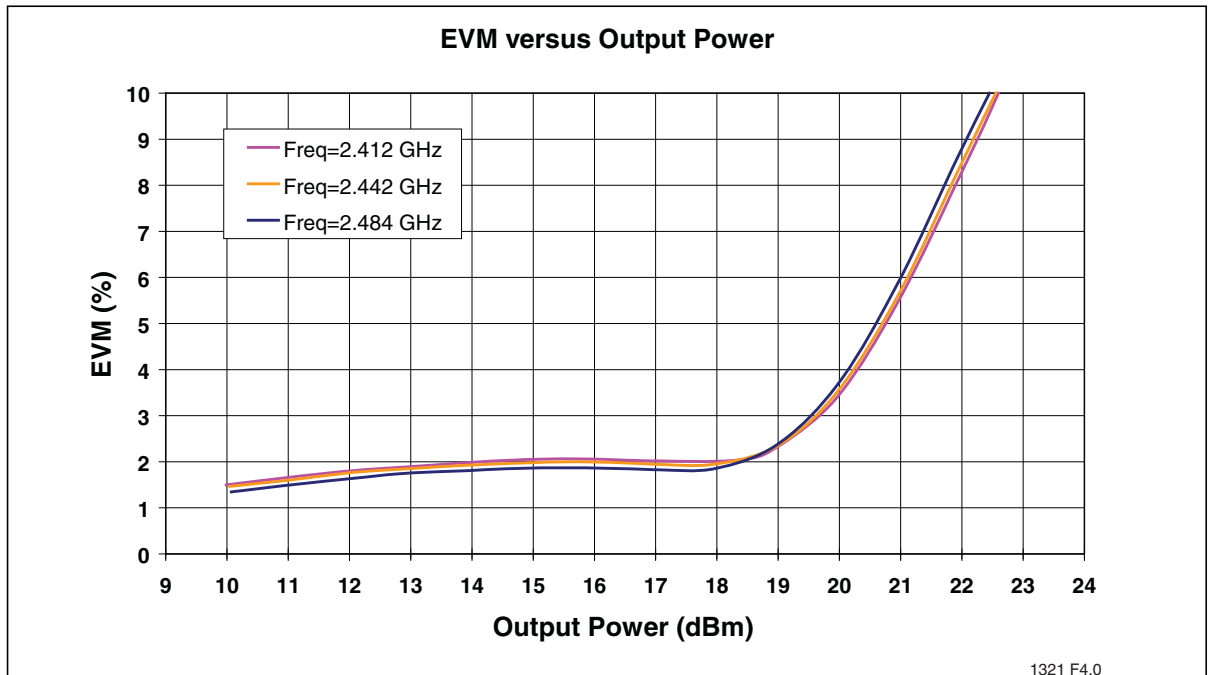

Figure 4: EMV versus Output Power

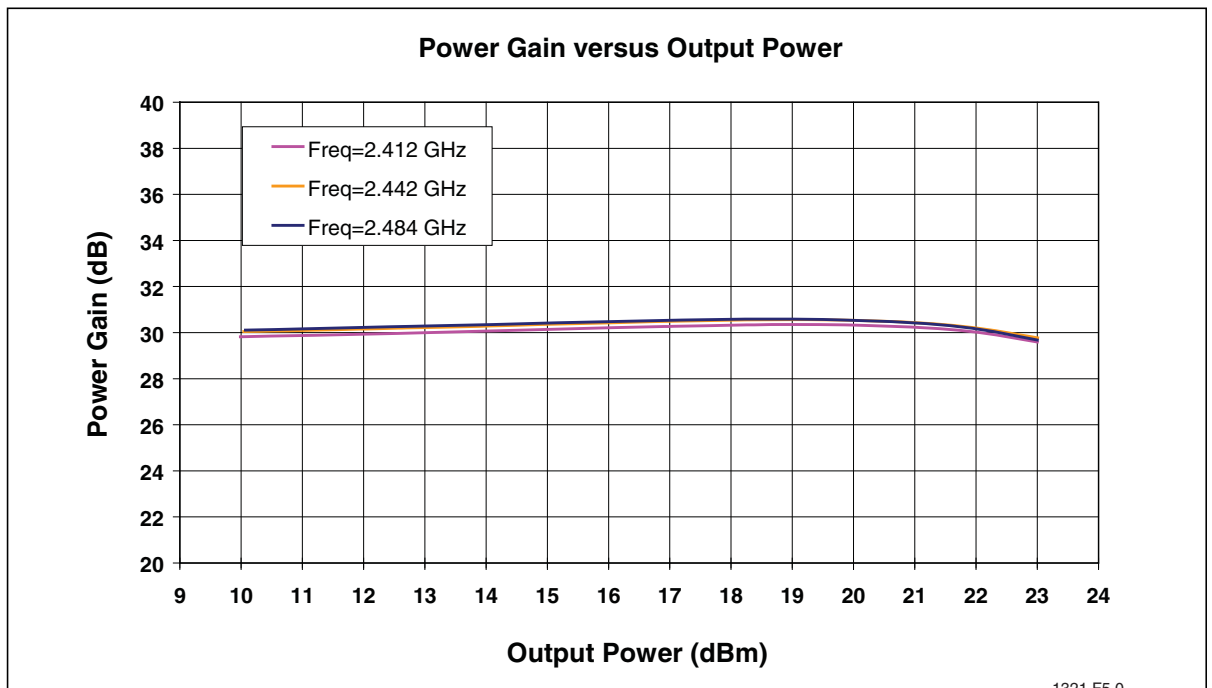

Figure 5: Power Gain versus Output Power



2.4 GHz High-Power, High-Gain Power Amplifier

SST12LP07

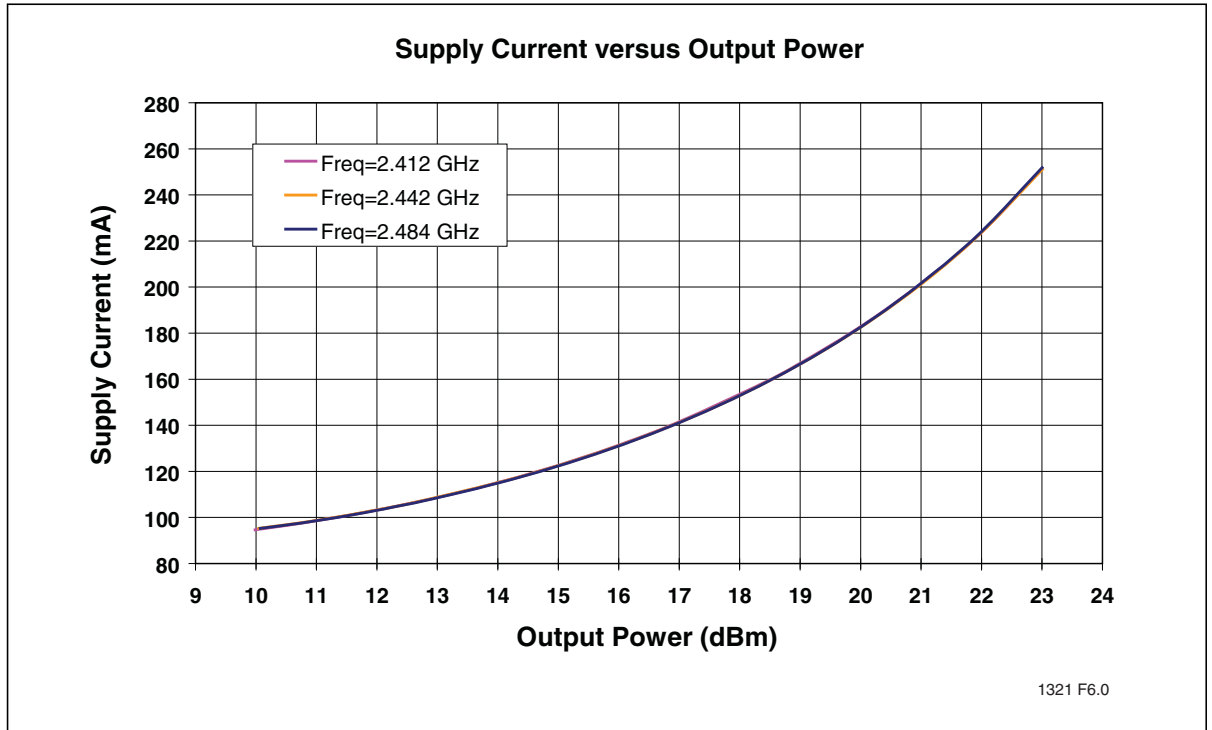

Figure 6: Total Current Consumption for 802.11g operation versus Output Power

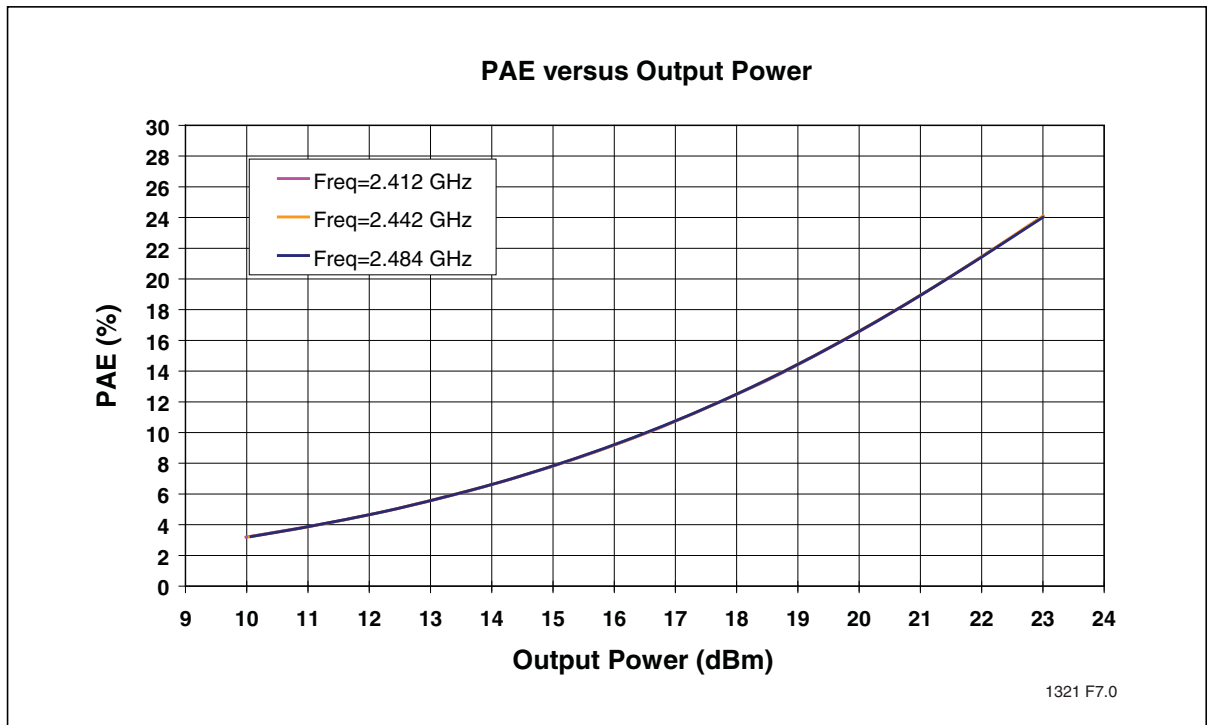

Figure 7: PAE versus Output Power



2.4 GHz High-Power, High-Gain Power Amplifier SST12LP07

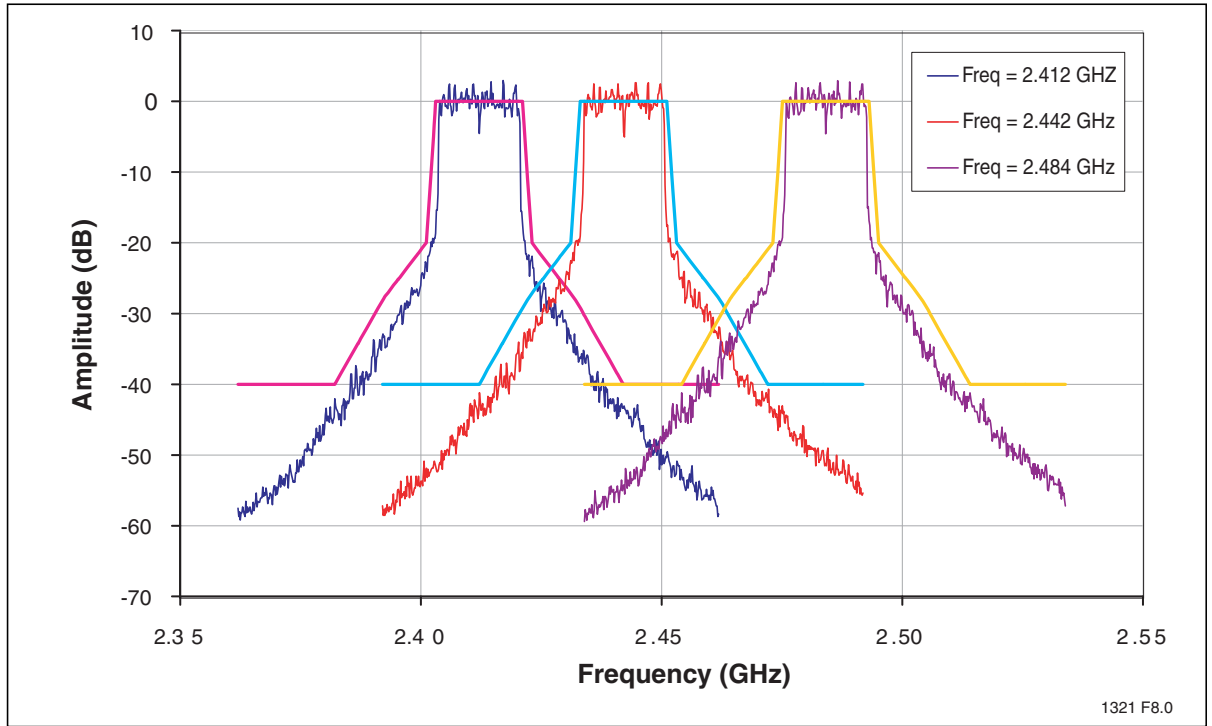

Figure 8: 802.11g Spectrum Mask at 22 dBm

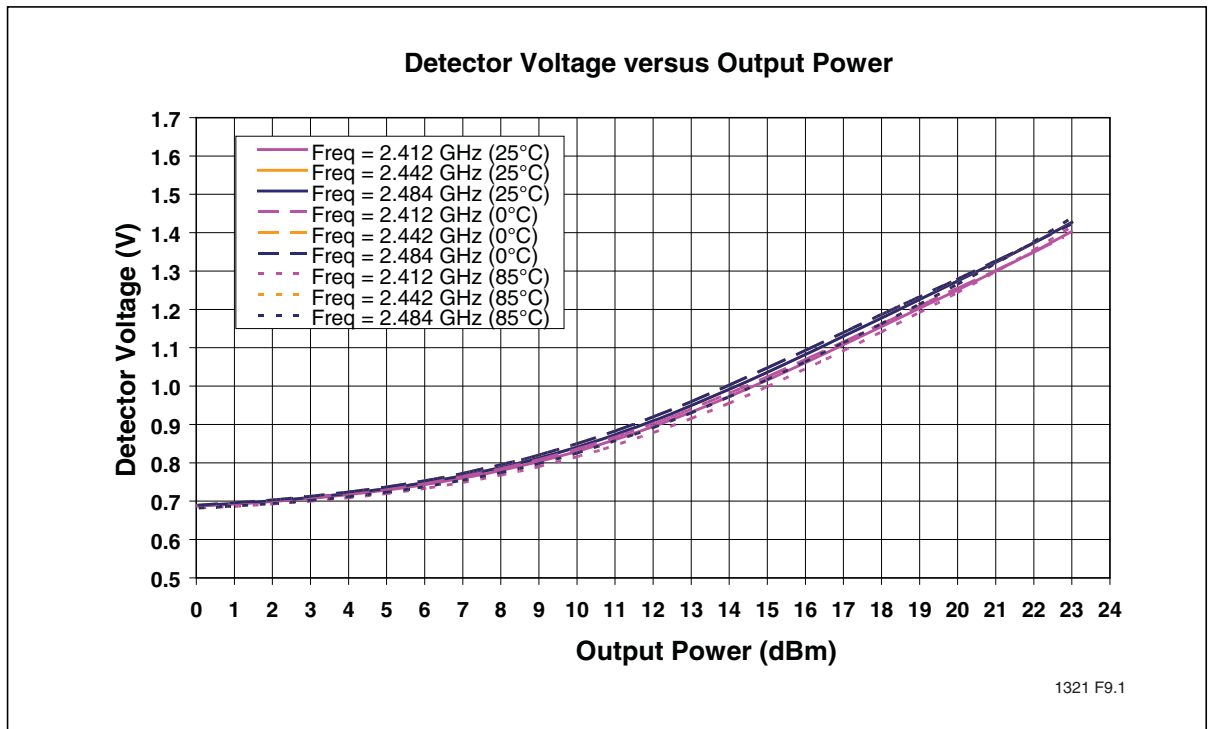

Figure 9: Detector Characteristics Over Temperature and Over Frequency



2.4 GHz High-Power, High-Gain Power Amplifier SST12LP07

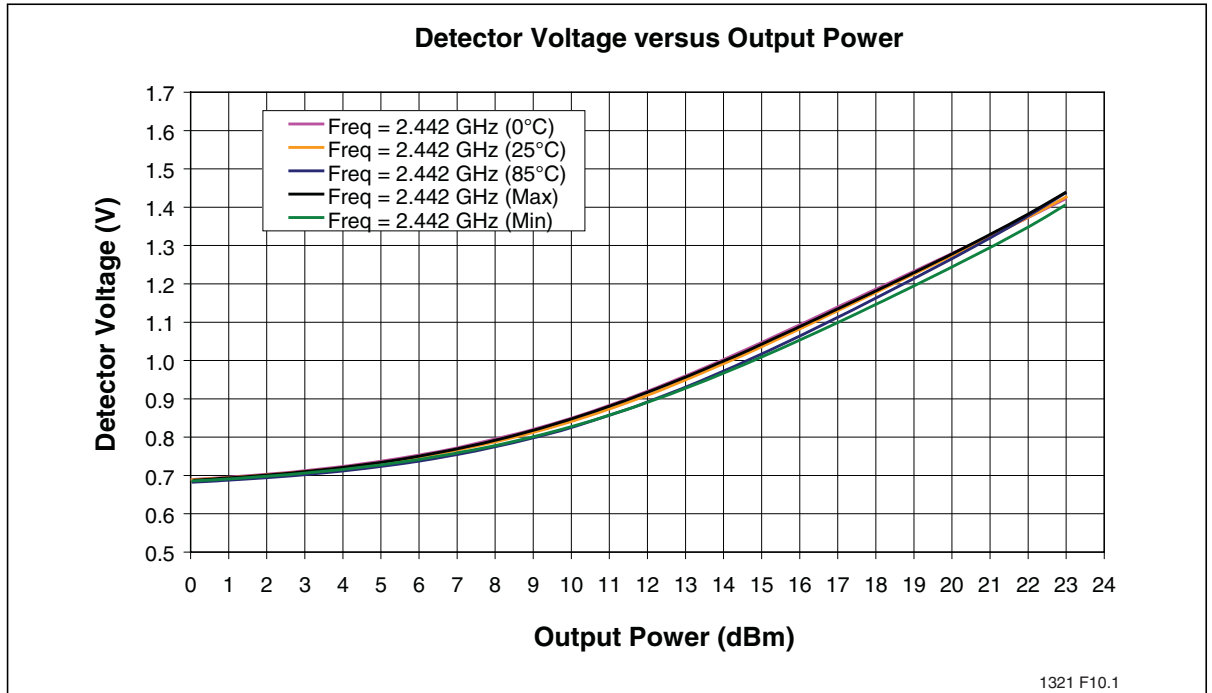

Figure 10: CH7 Detector Characteristics Over Temperature with 2:1 Output VSWR All Phases

Test Conditions: $V_{CC} = 3.3V$, $T_A = 25^\circ C$, 1 Mbps 802.11B CCK signal

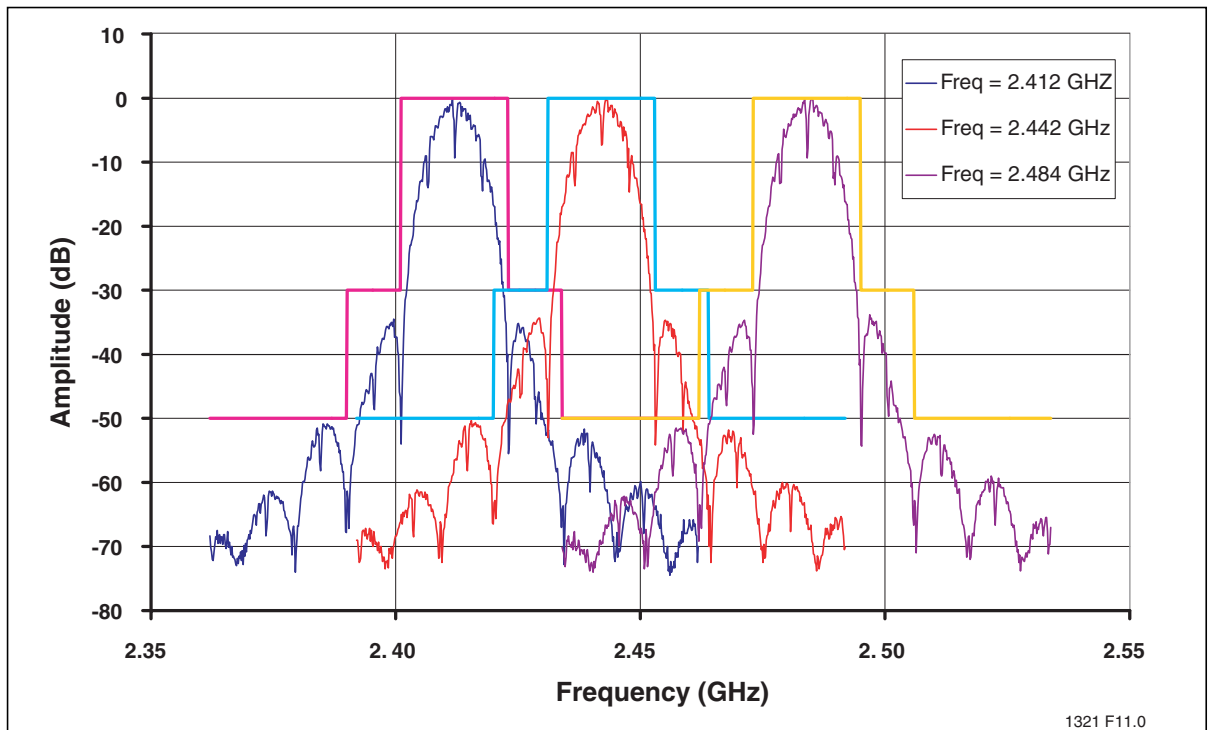

Figure 11: 802.11B Spectrum Mask at 22 dBm



2.4 GHz High-Power, High-Gain Power Amplifier

SST12LP07

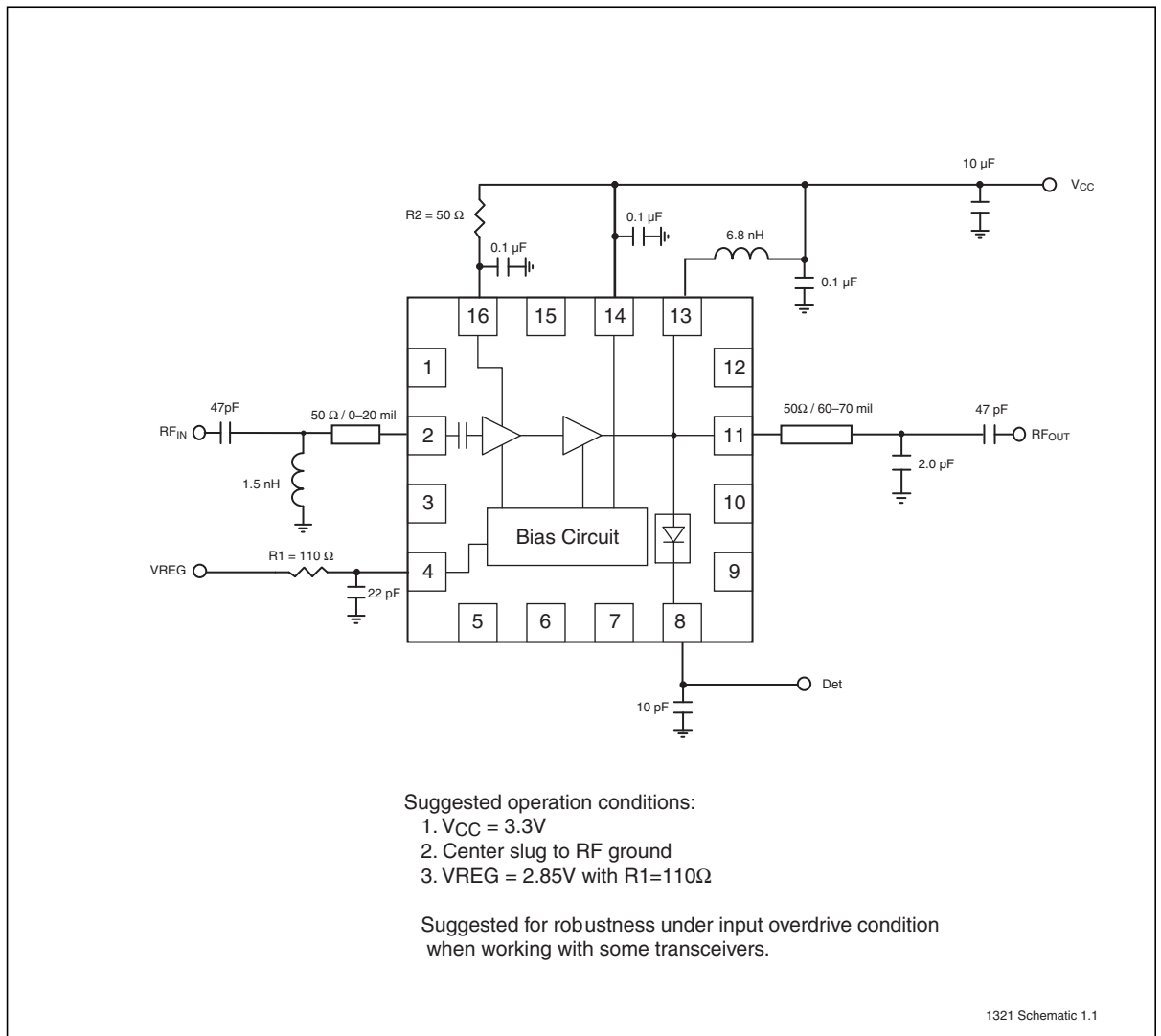
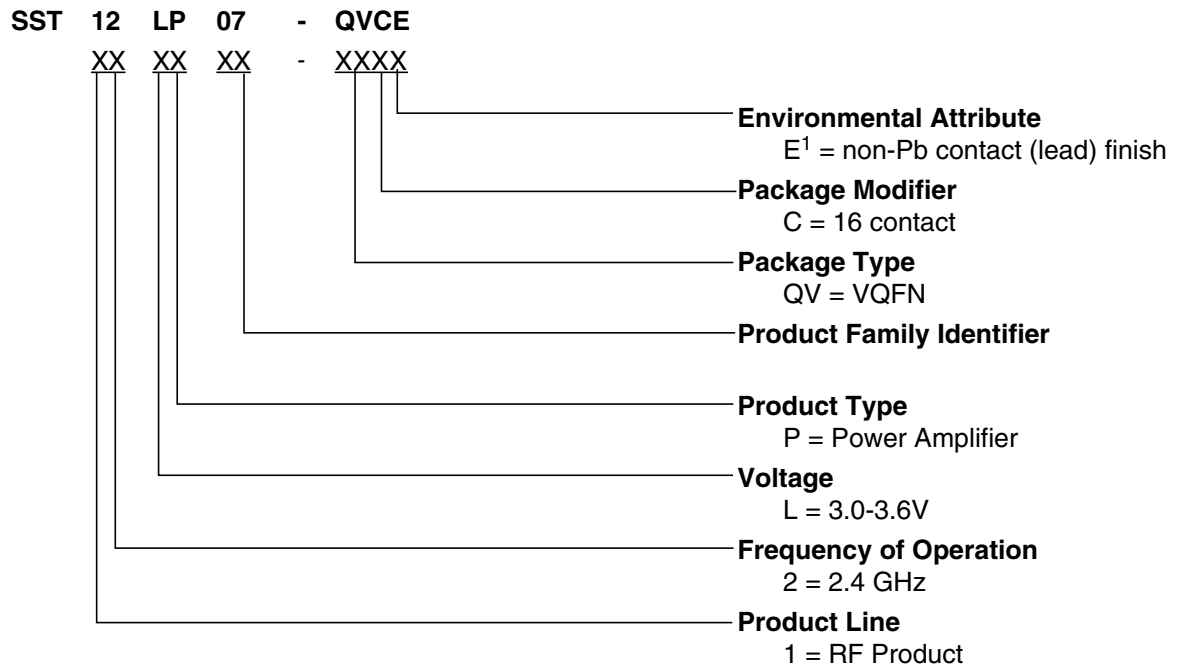

Figure 12: Typical Schematic for High-Power/High-Efficiency 802.11b/g Applications



Product Ordering Information



1. Environmental suffix "E" denotes non-Pb solder. SST non-Pb solder devices are "RoHS Compliant".

Valid combinations for SST12LP07

SST12LP07-QVCE

SST12LP07 Evaluation Kits

SST12LP07-QVCE-K

Note: Valid combinations are those products in mass production or will be in mass production. Consult your SST sales representative to confirm availability of valid combinations and to determine availability of new combinations.



Packaging Diagrams

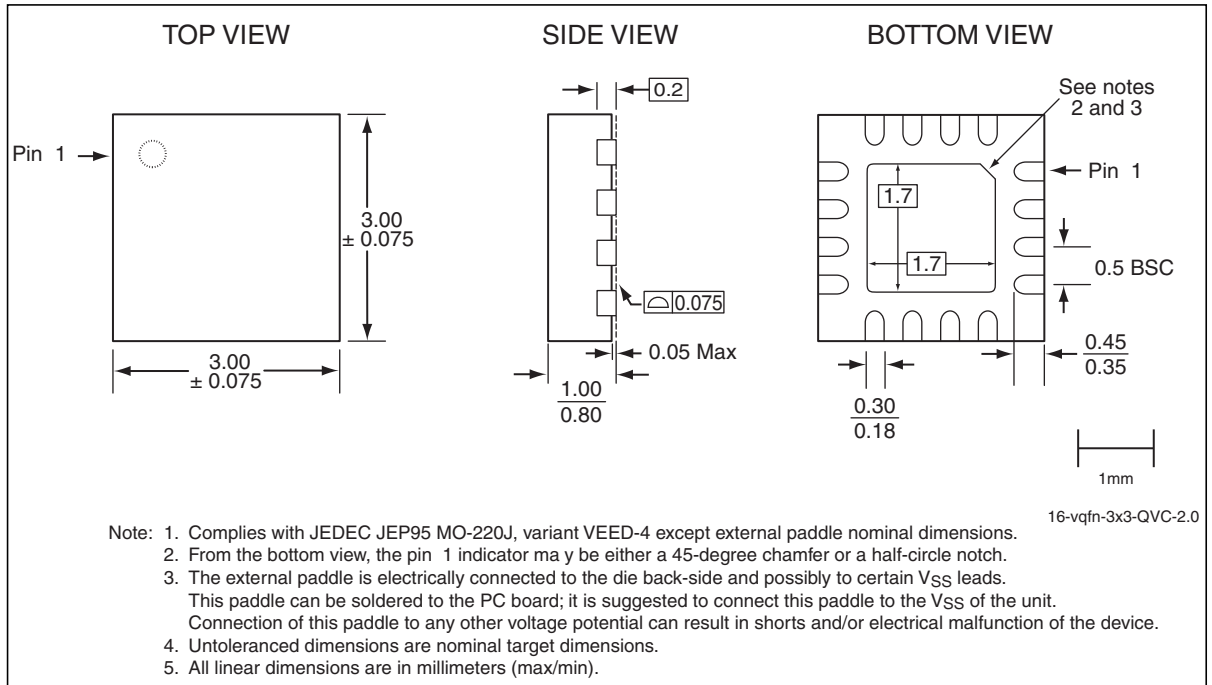

Figure 13: 16-contact Very-thin Quad Flat No-lead (VQFN)
SST Package Code: QVC



2.4 GHz High-Power, High-Gain Power Amplifier

SST12LP07

Table 5:Revision History

| Revision | Description | Date |
|----------|---|----------|
| 00 | <ul style="list-style-type: none"> Initial release of data sheet | May 2006 |
| 01 | <ul style="list-style-type: none"> Updated document status from Preliminary Specifications to Data Sheet | Mar 2008 |
| 02 | <ul style="list-style-type: none"> Updated "Contact Information" on page 14 | Mar 2009 |
| A | <ul style="list-style-type: none"> Applied new document format Released document under letter revision system Updated spec number from S71321 to DS75033 | Oct 2011 |

ISBN:978-1-61341-701-0

© 2011 Silicon Storage Technology, Inc—a Microchip Technology Company. All rights reserved.

SST, Silicon Storage Technology, the SST logo, SuperFlash, MTP, and FlashFlex are registered trademarks of Silicon Storage Technology, Inc. MPF, SQI, Serial Quad I/O, and Z-Scale are trademarks of Silicon Storage Technology, Inc. All other trademarks and registered trademarks mentioned herein are the property of their respective owners.

Specifications are subject to change without notice. Refer to www.microchip.com for the most recent documentation. For the most current package drawings, please see the Packaging Specification located at <http://www.microchip.com/packaging>.

Memory sizes denote raw storage capacity; actual usable capacity may be less.

SST makes no warranty for the use of its products other than those expressly contained in the Standard Terms and Conditions of Sale.

For sales office locations and information, please see www.microchip.com.

Silicon Storage Technology, Inc.
A Microchip Technology Company
www.microchip.com

Mouser Electronics

Authorized Distributor

Click to View Pricing, Inventory, Delivery & Lifecycle Information:

[Microchip:](#)

[SST11LP12-QCF](#) [SST12LP07-QVCE-MM007](#) [SST12LP14A-QVCE](#) [SST12LP14C-QVCE](#) [SST13LP05-MLCF](#)



Компания «ЭлектроПласт» предлагает заключение долгосрочных отношений при поставках импортных электронных компонентов на взаимовыгодных условиях!

Наши преимущества:

- Оперативные поставки широкого спектра электронных компонентов отечественного и импортного производства напрямую от производителей и с крупнейших мировых складов;
- Поставка более 17-ти миллионов наименований электронных компонентов;
- Поставка сложных, дефицитных, либо снятых с производства позиций;
- Оперативные сроки поставки под заказ (от 5 рабочих дней);
- Экспресс доставка в любую точку России;
- Техническая поддержка проекта, помощь в подборе аналогов, поставка прототипов;
- Система менеджмента качества сертифицирована по Международному стандарту ISO 9001;
- Лицензия ФСБ на осуществление работ с использованием сведений, составляющих государственную тайну;
- Поставка специализированных компонентов (Xilinx, Altera, Analog Devices, Intersil, Interpoint, Microsemi, Aeroflex, Peregrine, Syfer, Eurofarad, Texas Instrument, Miteq, Cobham, E2V, MA-COM, Hittite, Mini-Circuits, General Dynamics и др.);

Помимо этого, одним из направлений компании «ЭлектроПласт» является направление «Источники питания». Мы предлагаем Вам помощь Конструкторского отдела:

- Подбор оптимального решения, техническое обоснование при выборе компонента;
- Подбор аналогов;
- Консультации по применению компонента;
- Поставка образцов и прототипов;
- Техническая поддержка проекта;
- Защита от снятия компонента с производства.



Как с нами связаться

Телефон: 8 (812) 309 58 32 (многоканальный)

Факс: 8 (812) 320-02-42

Электронная почта: org@eplast1.ru

Адрес: 198099, г. Санкт-Петербург, ул. Калинина, дом 2, корпус 4, литера А.