

IEC Appliance Inlet C20 with Circuit Breaker TA45



Screw-on version from front or rear side  
 Rocker non-illuminated  
 white



Snap-in mounting from front side  
 Rocker illuminated  
 orange



See below:  
[Approvals and Compliances](#)

**Description**

- Panel mount :  
 Screw-on version from front or rear side, snap-in version from front side
- 2 Functions :  
 Appliance Inlet Protection class I , circuit breaker type TA45 2-pole
- Quick connect terminals 6.3 x 0.8 mm

**Characteristics**

- All single elements are already wired
- Unwired versions available on request
- Circuit Breaker non-illuminated or illuminated
- Suitable for use in equipment according to IEC/UL 60950

**Other versions on request**

- Unwired versions
- Variant with notch for V-Lock mating Cordsets

**References**

Alternative: version with line filter [EF12](#)

**Weblinks**

[pdf data sheet](#), [html datasheet](#), [General Product Information](#), [Distributor-Stock-Check](#), [Accessories](#), [Detailed request for product](#), [Landing Page](#)

Newly available variants corresponding to V-Lock mating cordset. The connector is equipped with a notch intended for use with the latching cordset. The cord latching system prevents against accidental removal of the cordset.

**Technical Data**

Ratings IEC	16A / 250VAC; 50Hz	appliance inlet/-outlet	C20 acc. to IEC 60320-1, UL 60320-1, CSA C22.2 no. 60320-1 (for cold conditions) pin-temperature 70 °C, 16A, Protection Class I
Ratings UL/CSA	20A / 250VAC; 60Hz	Circuit Breakers	Acc. IEC/EN 60934, UL 1077, CSA 22.2 no. 235 2-pole rocker switch, illuminated or non-illuminated. Optional with undervoltage- or remote trip release Short circuit capacity Icn: at In < 3A/240VAC : 10 x In at In ≥ 3A/240VAC : 300A
Dielectric Strength	> 1.5kVAC between L-N > 3kVAC between L/N-PE (1 min/50Hz)		
Allowable Operation Temperature	-10°C to 55°C		
IP-Protection	from front side IP40 acc. to IEC 60529		
Protection against electric shock	Suitable for appliances with protection class I acc. to IEC 61140		
Terminal	Quick connect terminals 6.3 x 0.8 mm		
Panel Thickness S	Screw: max 8mm Mounting screw torque max 0.5Nm Snap-in: 1.5/2/2.5 mm		
Material: Housing	Thermoplastic, black, UL 94V-0		

**Approvals and Compliances**



Detailed information on product approvals, code requirements, usage instructions and detailed test conditions can be looked up in [Details about Approvals](#)

SCHURTER products are designed for use in industrial environments. They have approvals from independent testing bodies according to national and international standards. Products with specific characteristics and requirements such as required in the automotive sector according to IATF 16949, medical technology according to ISO 13485 or in the aerospace industry can be offered exclusively with customer-specific, individual agreements by SCHURTER.

## Approvals



The approval mark is used by the testing authorities to certify compliance with the safety requirements placed on electronic products.

Approval Reference Type: EF11

Approval Logo	Certificates	Certification Body	Description
	<a href="#">VDE Approvals</a>	VDE	Certificate Number: 40001029
	<a href="#">UL Approvals</a>	UL	UL File Number: E96454

## Product standards

Product standards that are referenced

Organization	Design	Standard	Description
	Designed according to	IEC 60320-1	Appliance couplers for household and similar general purposes
	Designed according to	UL 60320-1	Standard for Attachment Plugs and Receptacles
	Designed according to	CSA C22.2 no. 60320-1	General Use Receptacles, Attachment Plugs, and Similar Wiring Devices





## Application standards

Application standards where the product can be used

Organization	Design	Standard	Description
	Designed for applications acc.	IEC/UL 60950	IEC 60950-1 includes the basic requirements for the safety of information technology equipment.

## Compliances

The product complies with following Guide Lines

Identification	Details	Initiator	Description
	<a href="#">CE declaration of conformity</a>	SCHURTER AG	The CE marking declares that the product complies with the applicable requirements laid down in the harmonisation of Community legislation on its affixing in accordance with EU Regulation 765/2008.
	<a href="#">RoHS</a>	SCHURTER AG	Directive RoHS 2011/65/EU, Amendment (EU) 2015/863
	<a href="#">China RoHS</a>	SCHURTER AG	The law SJ / T 11363-2006 (China RoHS) has been in force since 1 March 2007. It is similar to the EU directive RoHS.
	<a href="#">REACH</a>	SCHURTER AG	On 1 June 2007, Regulation (EC) No 1907/2006 on the Registration, Evaluation, Authorization and Restriction of Chemicals 1 (abbreviated as "REACH") entered into force.
	<a href="#">Landing Page V-Lock</a>	SCHURTER AG	V-Lock system are based on a matching plug-dose combination. The connector is equipped with a notch intended for use with the latching cordset. The cord latching system prevents against accidental removal of the cordset.

**Dimensions [mm]**  
 Screw-on mounting

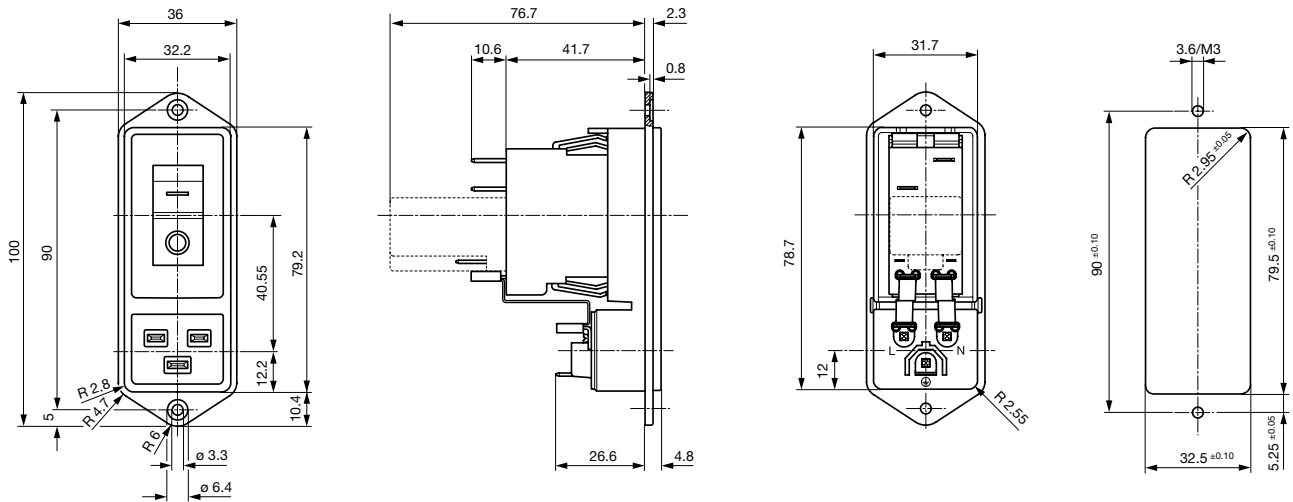

\*\* --- Version TA45 with undervoltage release

Snap-in mounting

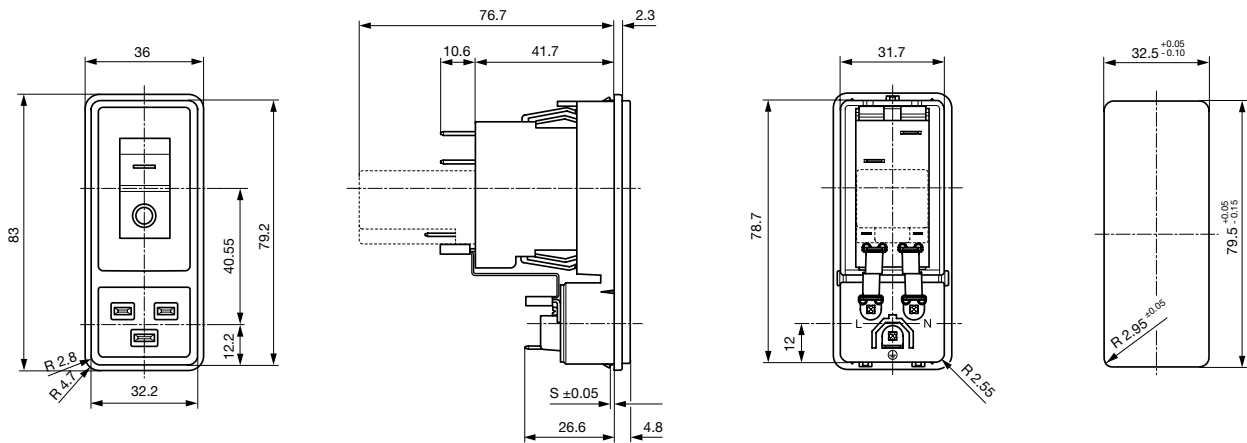

\*\* --- Version TA45 with undervoltage release

Diagrams

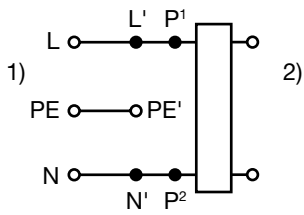

1) Line  
 2) Load

Effect of ambient temperature

The units are calibrated for an ambient temperature of +23°C. To determine the rated current for a lower or higher ambient temperature, use a correction factor (typical value) from the table below:

Ambient Temperature [°C]	Correction factor
-10	0.89
-5	0.91
0	0.92
+23	1.00
+30	1.03
+40	1.08
+55	1.16

Example: Rated current = 5 A, Environmental temperature = 40 °C, --> Correction factor = 1.08, Resulting current = 5.5 A --> Fount to next higher rated current: 6 A

Time-Current-Curves

Tripping Characteristics  $I_n < 3 A$

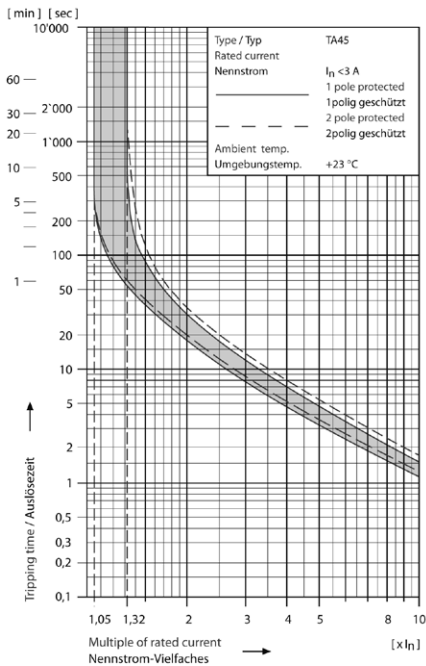

Tripping Characteristics  $I_n \geq 3 \dots < 18 A$

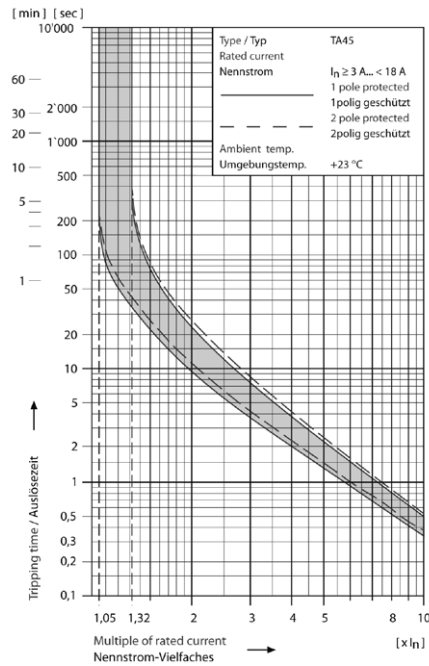

### Tripping Characteristics $I_n \geq 18$ A

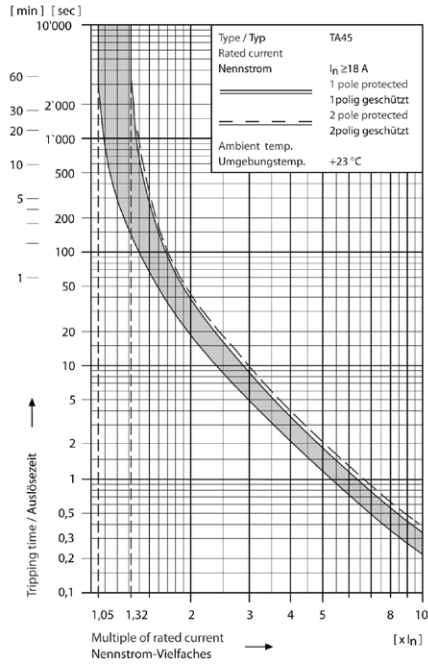

## Configuration code TA45

Type	Configuration code TA45												
EF11	A	B	T	W	F	1	5	0	C	0	000	111	000

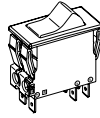

- Circuit Breaker of Equipment
- 2-pole, rocker actuated
- Quick connect terminal
- Other types on request

### Without release: code C0

#### Undervoltage release

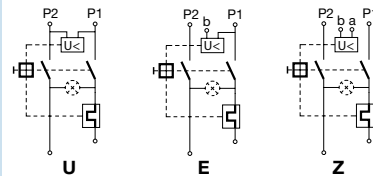

•	•	•
•	•	•
•	•	•

#### Remote trip release

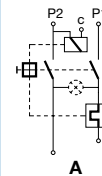

•	<b>2</b>	Rated voltage $U_n$
•	<b>3</b>	240 V AC
•	<b>4</b>	230 V AC
•		120 V AC

### Rated current circuit breaker of equipment

$I_n$	Code	$I_n$	Code	$I_n$	Code	$I_n$	Code
10,0	<b>100</b>	13,0	<b>130</b>	16,0	<b>160</b>	19,0	<b>190</b>
11,0	<b>110</b>	14,0	<b>140</b>	17,0	<b>170</b>	20,0	<b>200</b>
12,0	<b>120</b>	15,0	<b>150</b>	18,0	<b>180</b>		

Other rated currents on request

### Rocker legend

Surface	Illustration	Colour of print
<b>F</b> embossed	— ○	
<b>H</b> printed	ON OFF	white
<b>K</b> printed	ON OFF	black
<b>L</b> printed	— ○	white
<b>M</b> printed	— ○	black
<b>P</b> printed	I ○	white
<b>R</b> printed	I ○	black

Position of the rocker legend e.g F

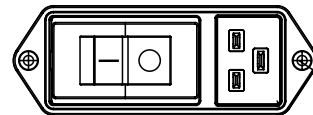

### Colours

Switch front	Rocker
<b>W</b> black	white
<b>B</b> black	black
<b>6</b> black	— orange transp.

### Diagram

Thermal overload protection	1-pole	2-pole
Without illumination	<b>ABT</b>	<b>ABD</b>
With illumination	220...240 V <b>A12</b> 110...120 V <b>A14</b>	<b>A32</b> <b>A34</b>

Configuration code (Order example)

Type	Configuration code TA45			
EF11	A B T W F 1 5 0 C 0	0 0 0	1 1 1	0 0 0

**Optional Variants**

- 0 standard
- 9 V-Lock notch

**Colour**

- 0 black

**Mounting**

- 0 Screw mounting
- 2 Snap-in mounting s = 1.5
- 3 Snap-in mounting s = 2.0
- 4 Snap-in mounting s = 2.5

**Terminal PE**

- 1 Quick-connect terminals 6.3x0.8mm

**Terminal N**

- 1 Quick-connect terminals 6.3x0.8mm, without connection to TA45
- 3 connection to TA45 non insulated

**Terminal L**

- 1 Quick-connect terminals 6.3x0.8mm, without connection to TA45
- 3 connection to TA45 non insulated

Packaging unit 16 Pcs

## Accessories

### Description

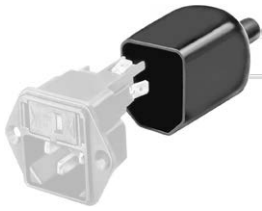

Assorted Covers  
Rear Cover

0859.0109



Cord retaining kits  
Cord retaining strain relief

Flat head, H

4700.0008

## Mating Outlets/Connectors

### Category / Description



#### Connector Overview complete

4795, Mounting: Power Cord, Cable Connector: IEC C19

4795

4790, Mounting: Power Cord, Screw Connector: IEC C19

4790

0104U, Mounting: Power Supply Cord, Screw clamps Connector: IEC C19

0104U

Connector further types to EF11

#### Power Supply Cord Overview complete



Cord Sets 10 A, North America, 3.0 m, Connector IEC C13, SJT 3x18 AWG, Transparent

4300.0920

Cord Sets 16 A, Europlug, 2.5 m, Connector IEC C19, H05VV-F3G1.5, black

6004.0395

Cord Sets 16 A, Interconnection, 1.0 m, Connector IEC C19, H05VV-F3G1.5, black

6020.0392

Cord Sets 16 A, Interconnection, 2.0 m, Connector IEC C19, H05VV-F3G1.5, black

6020.0394

Cord Sets 16 A, North America, 2.5 m, Connector IEC C19, SJT 3x14 AWG, black

6009.5195

Power Supply Cord further types to EF11

## Mating Outlets/Connectors shuttered



#### Power Cord Overview complete

VAC19KS, Overview, V-Lock cord retaining, diverse Connector IEC C19, diverse, black

VAC19KS

Power Cord further types to EF11





Компания «ЭлектроПласт» предлагает заключение долгосрочных отношений при поставках импортных электронных компонентов на взаимовыгодных условиях!

Наши преимущества:

- Оперативные поставки широкого спектра электронных компонентов отечественного и импортного производства напрямую от производителей и с крупнейших мировых складов;
- Поставка более 17-ти миллионов наименований электронных компонентов;
- Поставка сложных, дефицитных, либо снятых с производства позиций;
- Оперативные сроки поставки под заказ (от 5 рабочих дней);
- Экспресс доставка в любую точку России;
- Техническая поддержка проекта, помощь в подборе аналогов, поставка прототипов;
- Система менеджмента качества сертифицирована по Международному стандарту ISO 9001;
- Лицензия ФСБ на осуществление работ с использованием сведений, составляющих государственную тайну;
- Поставка специализированных компонентов (Xilinx, Altera, Analog Devices, Intersil, Interpoint, Microsemi, Aeroflex, Peregrine, Syfer, Eurofarad, Texas Instrument, Miteq, Cobham, E2V, MA-COM, Hittite, Mini-Circuits, General Dynamics и др.);

Помимо этого, одним из направлений компании «ЭлектроПласт» является направление «Источники питания». Мы предлагаем Вам помощь Конструкторского отдела:

- Подбор оптимального решения, техническое обоснование при выборе компонента;
- Подбор аналогов;
- Консультации по применению компонента;
- Поставка образцов и прототипов;
- Техническая поддержка проекта;
- Защита от снятия компонента с производства.



#### Как с нами связаться

**Телефон:** 8 (812) 309 58 32 (многоканальный)

**Факс:** 8 (812) 320-02-42

**Электронная почта:** [org@eplast1.ru](mailto:org@eplast1.ru)

**Адрес:** 198099, г. Санкт-Петербург, ул. Калинина, дом 2, корпус 4, литера А.