

E3X-NA

Simple and Easy-to-Use Amplifiers with a Sensitivity Adjuster Provided as a Standard Feature

- Intuitive LED bar display shows light levels at a glance.
- Utilizes OMRON's innovative wire-saving connector.
- Reduced wiring and space requirements for power lines.
- Optical communications prevents mutual interference for up to 5 amplifiers
- High-speed detection, mark-detecting, and water-resistant models also available.



CE



 Be sure to read *Safety Precautions* on page 10.

Ordering Information

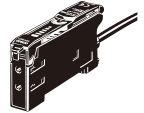
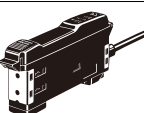

Amplifier Units Amplifier Units with Cables

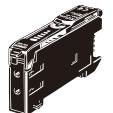
Item	Appearance	Control output	Model	
			NPN output	PNP output
Standard models		ON/OFF output	E3X-NA11	E3X-NA41
With self-diagnosis function			E3X-NA21	E3X-NA51
High-speed detection models			E3X-NA11F	E3X-NA41F
Mark-detecting models			E3X-NAG11	E3X-NAG41
Water-resistant models			E3X-NA11V	E3X-NA41V

Amplifier Units with Connectors

Item	Appearance	Applicable Connector (order separately)		Control output	Model	
					NPN output	PNP output
Standard models		Master	E3X-CN11	ON/OFF output	E3X-NA6	E3X-NA8
		Slave	E3X-CN12			
Water-resistant models (M8 connectors)		XS3F-M421-40□-A XS3F-M422-40□-A			E3X-NA14V	E3X-NA44V

Amplifier Unit Connectors (Order Separately) Note: Stickers for Connectors are included as accessories.

Item	Appearance	Cable length	No. of conductors	Model
Master Connector		2 m	3	E3X-CN11
Slave Connector			1	E3X-CN12



Combining Amplifier Units and Connectors

Refer to the following tables when placing an order.

Basically, Amplifier Units and Connectors are sold separately.

Amplifier Units			+	Applicable Connectors (Order Separately)	
Type	NPN	PNP		Master Connector	Slave Connector
Standard models	E3X-NA6	E3X-NA8		E3X-CN11 (3-wire)	E3X-CN12 (1-wire)
When Using 5 Amplifier Units				1 Master Connector + 4 Slave Connectors	
5 Amplifier Units			+	1 Master Connector + 4 Slave Connectors	



Sensor I/O Connectors (Order Separately)

Size	Cable specifications	Appearance	Cable type	Model	
M8	Standard cable	Straight connector 	2 m	Four-conductor cable	XS3F-M421-402-A
			5 m		XS3F-M421-405-A
		L-shaped connector 	2 m		XS3F-M422-402-A
			5 m		XS3F-M422-405-A

Note: Refer to *Introduction to Sensor I/O Connectors* for details.

Accessories (Order Separately)

Mounting Brackets

Appearance	Applicable models	Model	Quantity
	E3X-NA□ E3X-NA□F E3X-NAG□	E39-L143	1
	E3X-NA□V	E39-L148	

End Plate

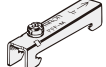
Appearance	Model	Quantity
	PFP-M	1

Ratings and Specifications

Amplifier Units

Item	Model	Type	Amplifier Units with Cables				Amplifier Units with Connectors		
			Standard models		High-speed detection models	Mark-detecting models	Water-resistant models	Standard models	Water-resistant models (M8 connectors)
			NPN output	E3X-NA11	E3X-NA21	E3X-NA11F	E3X-NAG11	E3X-NA11V	E3X-NA6
PNP output	E3X-NA41	E3X-NA51	E3X-NA41F	E3X-NAG41	E3X-NA41V	E3X-NA8	E3X-NA44V		
Light source (wavelength)	Red LED (680 nm)			Green LED (520 nm)	Red LED (680 nm)				
Power supply voltage	12 to 24 VDC \pm 10%, ripple (p-p): 10% max.								
Current consumption	35 mA max.		35 mA max. (for 24-VDC power supply)		35 mA max.				
Control output	Load current: 50 mA max.; residual voltage: 1 V max.; NPN/PNP (depends on model) open collector; Light-ON/Dark-ON mode selector								
Self-diagnosis output	None		Yes		None				
Response time	Operate or reset: 200 μ s max. *		Operate: 20 μ s max. Reset: 30 μ s max.		Operate or reset: 200 μ s max. *				
Sensitivity adjustment	8-turn sensitivity adjuster (with indicator)								
Protection circuits	Reverse polarity, output short-circuit, mutual interference prevention (optically synchronized)		Reverse polarity, output shortcircuit		Reverse polarity, output short-circuit, mutual interference prevention (optically synchronized)				
Timer function	OFF-delay timer: 40 ms (fixed)								
Ambient illumination (Receiver side)	Incandescent lamp: 10,000 lux max. Sunlight: 20,000 lux max.								
Ambient temperature range	Operating: Groups of 1 to 3 Amplifiers: -25°C to 55°C Groups of 4 to 11 Amplifiers: -25°C to 50°C Groups of 12 to 16 Amplifiers: -25°C to 45°C Storage: -30°C to 70°C (with no icing or condensation)								
Ambient humidity range	Operating and storage: 35% to 85% (with no condensation)								
Insulation resistance	20 M Ω min. (at 500 VDC)								
Dielectric strength	1,000 VAC at 50/60 Hz for 1 minute						500 VAC at 50/60 Hz for 1 minute		
Vibration resistance	Destruction: 10 to 55 Hz with a 1.5-mm double amplitude for 2 hrs each in X, Y and Z directions								
Shock resistance	Destruction: 500 m/s ² , for 3 times each in X, Y and Z directions								
Degree of protection	IEC 60529 IP50 (with Protective Cover attached)				IEC 60529 IP66 (with Protective Cover attached)	IEC 60529 IP50 (with Protective Cover attached)	IEC 60529 IP66 (with Protective Cover attached)		
Connection method	Pre-wired (standard cable length: 2 m)				Standard connector		Standard M8 connector		
Weight (packed state)	Approx. 100 g			Approx. 110 g		Approx. 55 g	Approx. 65 g		
Material	Case	Polybutylene terephthalate (PBT)							
	Cover	Polycarbonate			Polyethersulfone (PES)	Polycarbonate	Polyethersulfone (PES)		
Accessories	Instruction manual								

* When there are 8 or more Units mounted side-by-side, the response time will be 350 μ s max.

Amplifier Unit Connectors

Item	Model	E3X-CN11	E3X-CN12
Rated current	2.5 A		
Rated voltage	50 V		
Contact resistance	20 m Ω max. (20 mVDC max., 100 mA max.) (The above figure is for connection to the Amplifier Unit and the adjacent Connector. It does not include the conductor resistance of the cable.)		
Number of insertions	Destruction: 50 times (for connection to the Amplifier Unit and the adjacent Connector)		
Material	Housing	Polybutylene terephthalate (PBT)	
	Contact	Phosphor bronze/gold-plated nickel	
Weight (packed state)	Approx. 55 g		Approx. 25 g

**Sensing Distance
Through-beam Models**

(Unit: mm)

Type		Model	E3X-NA□		
			General-purpose models	High-speed models	
Standard models	Flexible (new standard)	E32-T11R/E32-T12R/E32-T15XR/E32-TC200BR(B4R)	280	80	
		E32-T14LR/E32-T15YR/E32-T15ZR	110	33	
		E32-T21R/E32-T22R/E32-T222R/E32-T25XR/ E32-TC200FR(F4R)	60	18	
		E32-T24R/E32-T25YR/E32-T25ZR	30	9	
	Standard	E32-TC200/E32-T12/E32-T15X/E32-TC200B(B4)	400	120	
		E32-T14L/E32-T15Y/E32-T15Z	240	70	
		E32-TC200A	360	100	
		E32-TC200E/E32-T22/E32-T222/E32-T25X/E32-TC200F(F4)	100	30	
		E32-T24/E32-T25Y/E32-T25Z	90	27	
	Break resistant	E32-T11/E32-T12B/E32-T15XB	360	100	
		E32-T21/E32-T221B/E32-T22B	100	30	
		E32-T25XB	75	20	
	Fluorine coating	E32-T11U	360	100	
	Special-beam models	Long distance, high power	E32-T17L	14000	4200
E32-TC200 + E39-F1			3000	900	
E32-T11R + E39-F1			2100	630	
E32-T11 + E39-F1			2000	600	
E32-T14			1800	540	
E32-T11L/E32-T12L			700	210	
E32-T11L + E39-F2			500	150	
E32-T11R + E39-F2			220	65	
E32-T11 + E39-F2			360	100	
E32-T21L/E32-T22L			200	60	
Ultracompact, ultrafine sleeve		E32-T223R	60	18	
		E32-T33-S5	20	6	
		E32-T333-S5	5	1.5	
Fine beam (nar- row vision field)		E32-T334-S5	2.5	0.8	
		E32-T22S	1000	300	
Area sensing		E32-T24S	700	210	
		E32-T16PR	450	130	
		E32-T16P	600	180	
		E32-T16JR	390	110	
		E32-T16J	520	150	
		E32-T16WR	690	200	
		E32-T16W	920	270	
		E32-T16	1500	450	
		E32-M21	300	90	
Environment- resistive models		Heat resistant	E32-T51	400	120
			E32-T54	130	35
			E32-T81R-S	180	50
	E32-T61-S + E39-F2		390	130	
	E32-T61-S + E39-F1		3000	900	
	E32-T84S-S		700	210	
	E32-T61-S		300	90	
	Chemical resistant	E32-T11F	1050	380	
		E32-T12F	1600	480	
		E32-T14F	200	60	
		E32-T51F	700	200	
		E32-T81F-S	350	100	
	Vacuum resistant	E32-T51V	100	---	
		E32-T51V + E39-F1V	600	---	
		E32-T54V	65	---	
		E32-T54V + E39-F1V	390	---	
E32-T84SV		250	---		

Reflective Models

(Unit: mm)

Type		Model	E3X-NA□		
			General-purpose models	High-speed models	
Standard models	Flexible (new standard)	E32-D11R/E32-D12R/E32-D15XR/E32-DC200BR(B4R)	90	30	
		E32-D14LR	16	5	
		E32-D15YR/E32-D15ZR	20	5	
		E32-D211R/E32-D21R/E32-D22R/E32-D25XR/E32-DC200FR(F4R)	15	5	
		E32-D24R	7	2.3	
		E32-D25YR/E32-D25ZR	4	1.2	
	Standard	E32-DC200/E32-D15X/E32-DC200B(B4)	150	50	
		E32-D12	120	40	
		E32-D14L	40	13	
		E32-D15Y/E32-D15Z	50	15	
		E32-D211/E32-DC200E/E32-D22/E32-D25X/E32-DC200F(F4)	36	12	
		E32-D24	15	5	
	Break resistant	E32-D25Y/E32-D25Z	10	3.3	
		E32-D11/E32-D15XB	90	30	
		E32-D21B/E32-D221B	35	10	
		E32-D21/E32-D22B	15	5	
	Fluorine coating	E32-D25XB	25	8	
		E32-D11U	90	30	
	Special-beam models	Long distance, high power	E32-D16	40 to 400	55 to 70
			E32-D11L	200	65
E32-D21L/E32-D22L			50	17	
Ultracompact, ultrafine sleeve		E32-D33	10	3.3	
		E32-D331	1.5	0.5	
Coaxial, small spot		E32-CC200R	75	25	
		E32-CC200	150	50	
		E32-D32L	80	25	
		E32-C31/E32-D32	40	13	
		E32-C42 + E39-F3A	Spot diameter of 0.1 to 0.6 mm at 6 to 15 mm.		
		E32-D32 + E39-F3A	Spot diameter of 0.5 to 1mm at 6 to 15 mm.		
		E32-C41 + E39-F3A-5	Spot diameter of 0.1 mm at 7 mm		
		E32-C31 + E39-F3A-5	Spot diameter of 0.5 mm at 7 mm.		
		E32-C41 + E39-F3B	Spot diameter of 0.2 mm at 17 mm.		
E32-C31 + E39-F3B		Spot diameter of 0.5 mm at 17 mm.			
E32-C31 + E39-F3C		Spot diameter of 4 mm max. at 0 to 20 mm.			
Area sensing		E32-D36P1	75	25	
Retro-reflective		E32-R21 + E39-R3 (provided)	10 to 250		
		E32-R16 + E39-R1 (provided)	150 to 1500	150 to 1000	
Convergent-reflective		E32-L25/E32-L25A	3.3		
		E32-L24S	0 to 4		
		E32-L24L	2 to 6 (center 4)		
		E32-L25L	5.4 to 9 (center 7.2)		
	E32-L86	4 to 10			
Environment-resistant models	Heat resistant	E32-L16	0 to 15	0 to 13	
		E32-D51	120	40	
		E32-D81R/E32-D61	45	15	
	Chemical resistant	E32-D73	30	10	
		E32-D12F	50	16	
		E32-D14F	20	6.5	

Application-specific Models

(Unit: mm)

Type		Model	E3X-NA□	
			General-purpose models	High-speed models
Application-specific Models	Label detection	E32-G14	10	
		E32-T14	1800	540
	Liquid-level detection	E32-L25T	Applicable tube: Transparent tube with a diameter in the range 8 to 10 mm and a recommended wall thickness of 1 mm	
		E32-D36T	Applicable tube: Transparent tube (no diameter restrictions)	
		E32-D82F1(F2)	Liquid-contact model	

Green Light Source Models

(Unit: mm)

Type		Model	E3X-NAG□
			Green Light Source Models
Through-beam models	Standard	E32-T11R/E32-T12R/E32-T15XR/E32-TC200BR(B4R)	50
		E32-T14LR/E32-T15YR/E32-T15ZR	20
		E32-TC200/E32-T12/E32-T15X/E32-TC200B(B4)	75
		E32-T14L/E32-T15Y/E32-T15Z	45
	Special beam	E32-T11L/E32-T12L	130
Reflective	Standard	E32-D11R/E32-D12R/E32-D15XR/E32-DC200BR(B4R)	15
		E32-D14LR	3.5
		E32-D15YR/E32-D15ZR	3.3
		E32-DC200/E32-D15X/E32-DC200B(B4)	25
		E32-D14L	10
		E32-D15Y/E32-D15Z	8
	Special beam	E32-D11L	35
		E32-CC200R	12
		E32-CC200	25
		E32-D32L	12
		E32-C31/E32-D32	6
Application specific	Label detection	E32-T14	330
		E32-G14	10

Refer to *E32 Series* for details on Fiber Units.

Engineering Data (Typical)

Number of Turns of Sensitivity Adjuster vs. Sensing Distance

E32-T11L

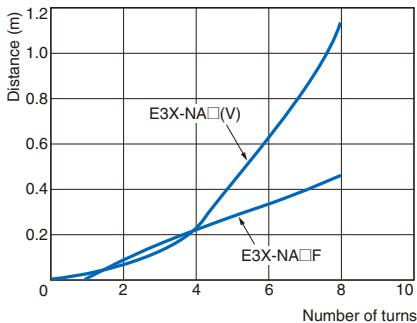

E32-D11L

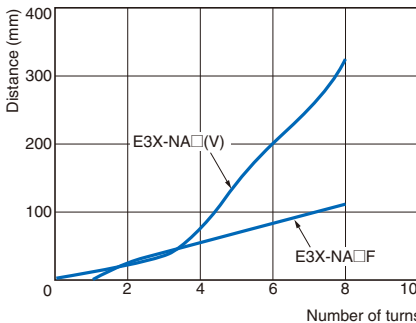

Sensing Distance vs. Differential Travel

E32-T11L

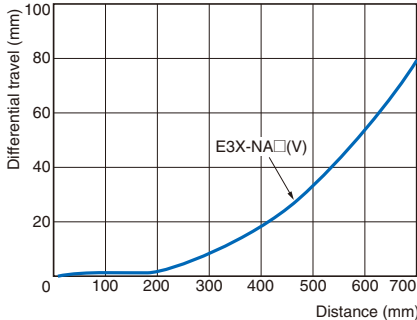

E32-D11L

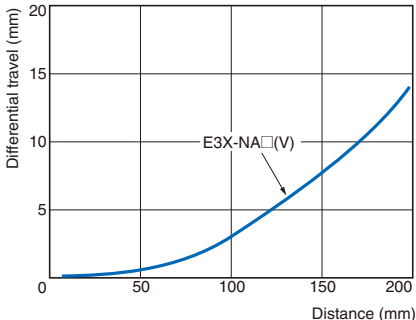

I/O Circuit Diagrams

NPN Output

Model	Operation mode	Timing charts	Operation selector	Output circuit
E3X-NA11 E3X-NA6 E3X-NAG11 E3X-NA11F E3X-NA11V E3X-NA14V	Light-ON		LIGHT ON (L-ON)	
	Dark-ON		DARK ON (D-ON)	
E3X-NA21	Light-ON		LIGHT ON (L-ON)	
	Dark-ON		DARK ON (D-ON)	

M8 Connector Pin Arrangement

Note: Pin 2 is not used.



PNP Output

Model	Operation mode	Timing charts	Operation selector	Output circuit
E3X-NA41 E3X-NA8 E3X-NAG41 E3X-NA41F E3X-NA41V E3X-NA44V	Light-ON	<p>Incident light: ON (green bar), OFF (white bar) No incident light: OFF (white bar) Operation indicator (orange): ON (green bar), OFF (white bar) Output transistor: ON (green bar), OFF (white bar) Load (relay): Operate (green bar), Reset (white bar) (Between brown and black leads)</p>	LIGHT ON (L-ON)	<p>M8 Connector Pin Arrangement: Note: Pin 2 is not used.</p>
	Dark-ON	<p>Incident light: ON (green bar), OFF (white bar) No incident light: ON (green bar), OFF (white bar) Operation indicator (orange): OFF (white bar), ON (green bar) Output transistor: ON (green bar), OFF (white bar) Load (relay): Operate (green bar), Reset (white bar) (Between brown and black leads)</p>	DARK ON (D-ON)	<p>M8 Connector Pin Arrangement: Note: Pin 2 is not used.</p>
E3X-NA51	Light-ON	<p>Incident light: ON (green bar), OFF (white bar) No incident light: OFF (white bar) Operation indicator (orange): ON (green bar), OFF (white bar) Output transistor: ON (green bar), OFF (white bar) Load (relay): Operate (green bar), Reset (white bar) (Between brown and black leads)</p>	LIGHT ON (L-ON)	<p>12 to 24 VDC Self-diagnosis output 0 V</p>
	Dark-ON	<p>Incident light: ON (green bar), OFF (white bar) No incident light: ON (green bar), OFF (white bar) Operation indicator (orange): OFF (white bar), ON (green bar) Output transistor: ON (green bar), OFF (white bar) Load (relay): Operate (green bar), Reset (white bar) (Between brown and black leads)</p>	DARK ON (D-ON)	<p>12 to 24 VDC Self-diagnosis output 0 V</p>

Plug (Sensor I/O Connector)

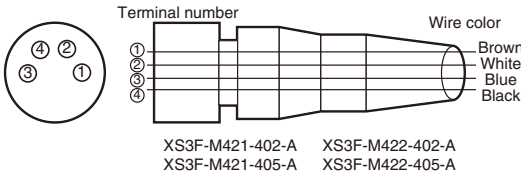

Classification	Wire color	Connection pin	Application
DC	Brown	1	Power supply (+V)
	White	2	---
	Blue	3	Power supply (0 V)
	Black	4	Output

Note: Pin 2 is not used.

Nomenclature

Amplifier Units

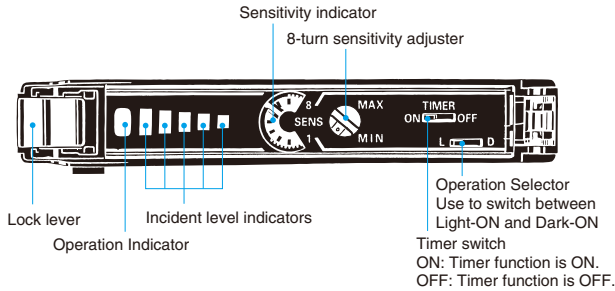

Safety Precautions

Refer to *Warranty and Limitations of Liability*.

⚠ WARNING

This product is not designed or rated for ensuring safety of persons either directly or indirectly. Do not use it for such purposes.



Precautions for Correct Use

Do not use the product in atmospheres or environments that exceed product ratings.

Amplifier Units

● Designing

Communications Hole

The hole on the side of the Amplifier Unit is a communications hole for preventing mutual interference when Amplifier Units are mounted side-by-side. The E3X-MC11 Mobile Console (order separately) cannot be used.

If an excessive amount of light is received via the Sensor, the mutual interference prevention function may not work. In this case, make the appropriate adjustments using the sensitivity adjuster. The mutual interference prevention function will not operate when the E3X-NA is used side-by-side with E3X-DA-N models.

● Mounting

DIN Track Mounting/Removal

Mounting Amplifier Units

1. Mount the Amplifier Units one at a time onto the DIN track.

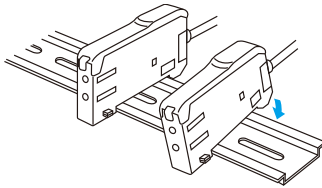

2. Slide the Amplifier Units together, line up the clips, and press the Amplifier Units together until they click into place.

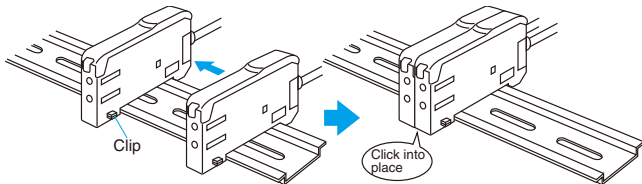

Removing Amplifier Units

Slide Amplifier Units away from each other, and remove from the DIN track one at a time. (Do not attempt to remove Amplifier Units from the DIN track without separating them first.)

- Note: 1. The specifications for ambient temperature will vary according to the number of Amplifier Units used together. For details, refer to *Ratings and Specifications*.
 2. Always turn OFF the power supply before mounting or removing Amplifier Units.

Fiber Connection and Disconnection

The E3X Amplifier Unit has a lock lever. Connect or disconnect the fibers to or from the E3X Amplifier Unit using the following procedures:

1. Connection

Open the Protective Cover, insert the fibers according to the fiber insertion marks on the side of the Amplifier Unit, and lower the lock lever.

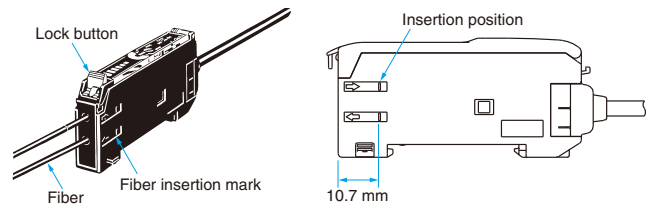

2. Disconnection

Remove the Protective Cover and raise the lock lever to pull out the fiber.

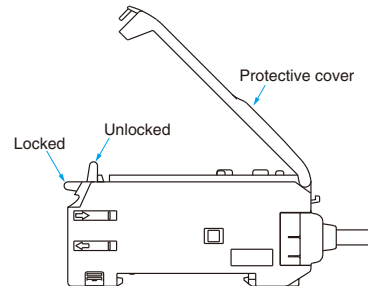

Note: To maintain the fiber properties, confirm that the lock is released before removing the fiber.

3. Precautions for Fiber Connection/Disconnection

Be sure to lock or unlock the lock lever within an ambient temperature range between -10°C and 40°C.

● Operating Environment

Ambient Conditions

If dust or dirt adhere to the hole for optical communications, it may prevent normal communications. Be sure to remove any dust or dirt before using the Units.

● Other

Protective Cover

Be sure to mount the Protective Cover before use.

Amplifier Units with Connectors

● Mounting

Mounting Connectors

1. Insert the Master or Slave Connector into the Amplifier Unit until it clicks into place.

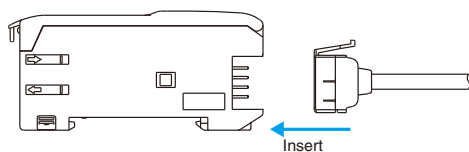

2. Join Amplifier Units together as required after all the Master and Slave Connectors have been inserted.
3. Attach the seals (provided as accessories) to the sides of Master and Slave Connectors that are not connected to other Connectors.

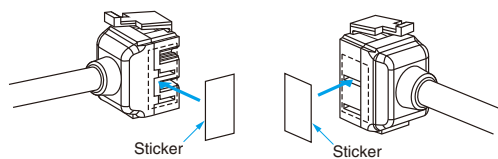

Note: Attach the stickers to the sides with grooves.

Removing Connectors

1. Slide the slave Amplifier Unit for which the Connector is to be removed away from the rest of the group.
2. After the Amplifier Unit has been separated, press down on the lever on the Connector and remove it. (Do not attempt to remove Connectors without separating them from other Amplifier Units first.)

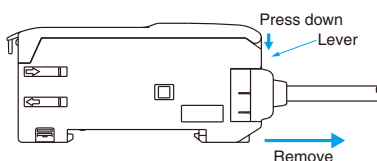

Mounting End Plate (PFP-M)

Depending on how it is mounted, an Amplifier Unit may move during operation. In this case, use an End Plate.

Before mounting an End Plate, remove the clip from the master Amplifier Unit using a nipper or similar tool.

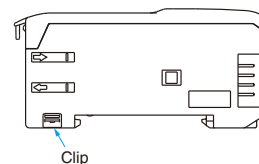

The clip can also be removed using the following mechanism, which is incorporated in the construction of the section underneath the clip.

1. Insert the clip to be removed into the slit underneath the clip on another Amplifier Unit.

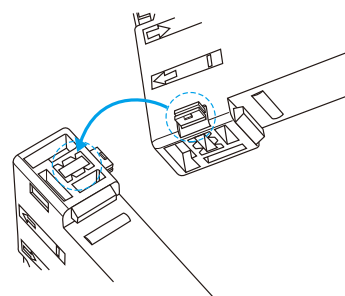

2. Remove the clip by rotating the Amplifier Unit.

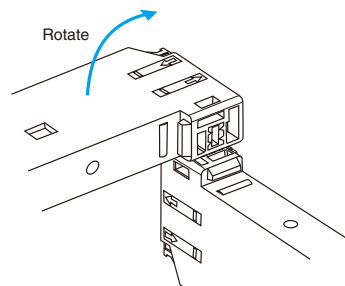

Pull Strengths for Connectors (Including Cables)

E3X-CN11: 30 N max.

E3X-CN12: 12 N max.

Dimensions

Amplifier Units

Amplifier Units with Cables

E3X-NA11
E3X-NA11F
E3X-NA41
E3X-NA41F
E3X-NAG11
E3X-NAG41
E3X-NA21
E3X-NA51

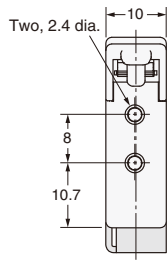
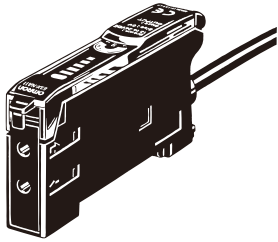

With Mounting Bracket Attached

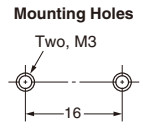
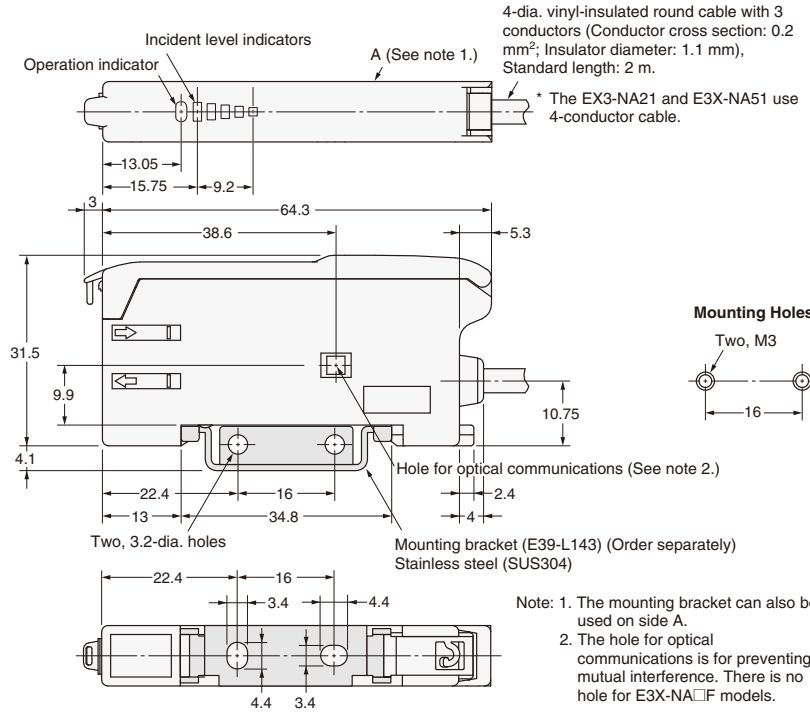

- Note: 1. The mounting bracket can also be used on side A.
2. The hole for optical communications is for preventing mutual interference. There is no hole for E3X-NA□F models.

Amplifier Units with Cables, Water-resistant Models

E3X-NA11V
E3X-NA41V

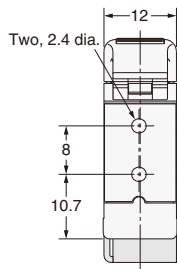
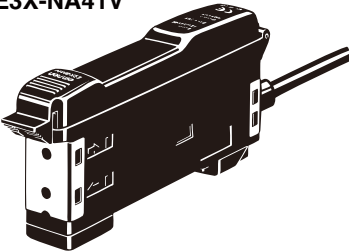

With Mounting Bracket Attached

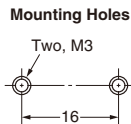
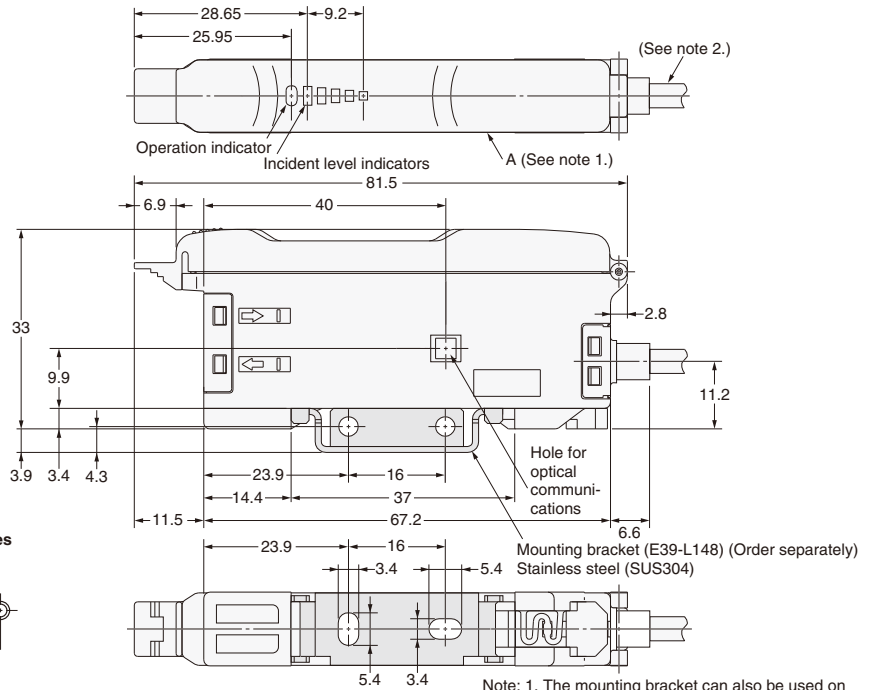

- Note: 1. The mounting bracket can also be used on side A.
2. 4-dia. vinyl-insulated round cable with 3 conductors (Conductor cross section: 0.45 mm², Insulator diameter: 1.1 mm), Standard length: 2 m.

Amplifier Units with Connectors

E3X-NA6

E3X-NA8

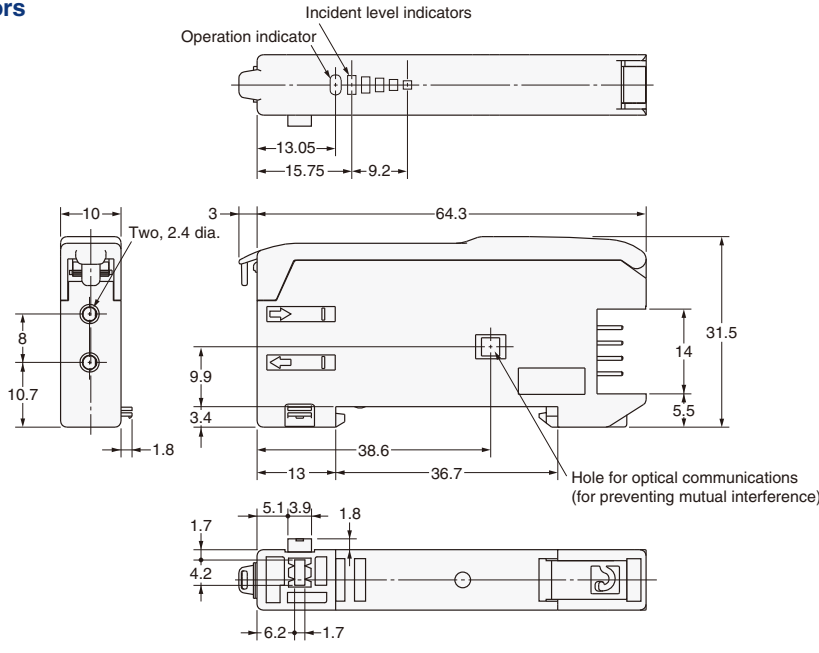
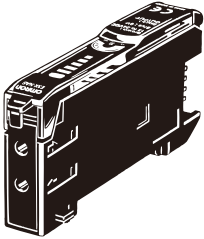

Dimensions with Master Connector Connected

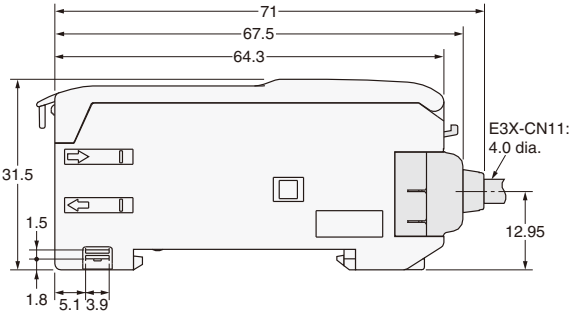

Dimensions with Slave Connector Connected

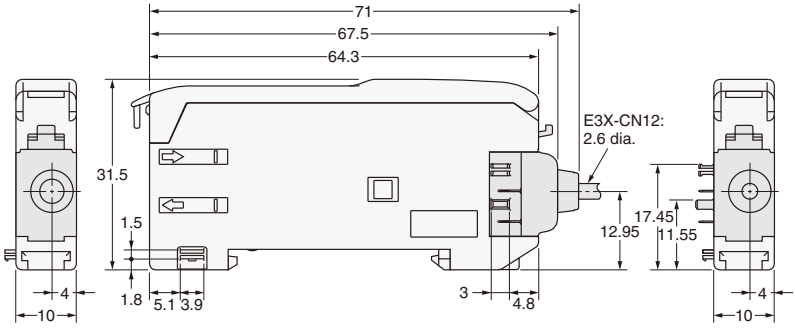

Amplifier Units with Connectors, Water-resistant

Models
E3X-NA14V
E3X-NA44V

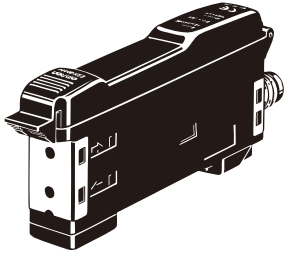

* The mounting bracket can also be used on this side.

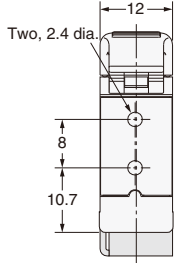

Mounting Holes

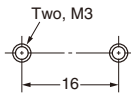

With Mounting Bracket Attached

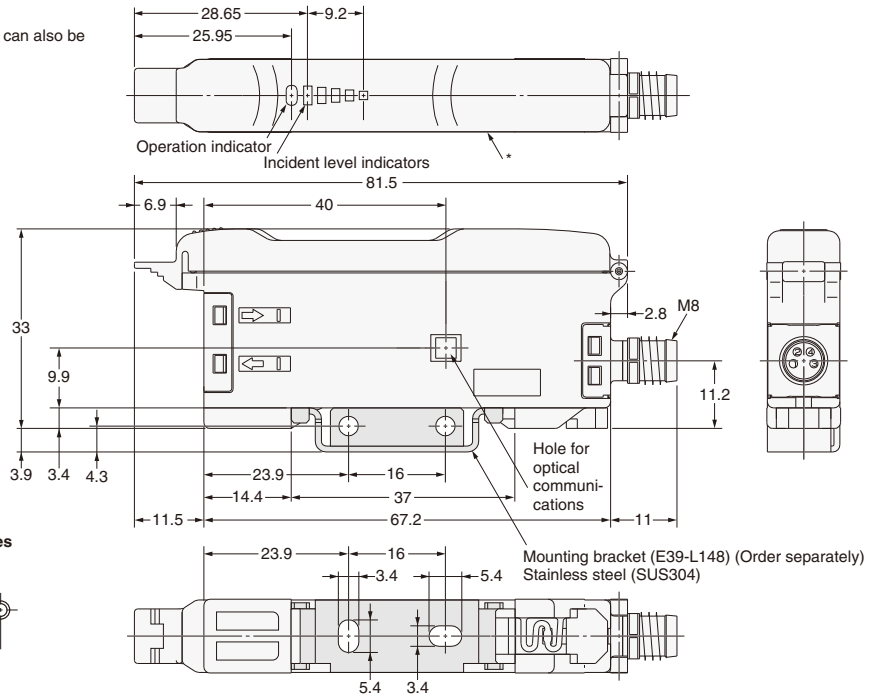

Amplifier Unit Connectors
Sensor I/O Connectors

Accessories (Order Separately)

Mounting Brackets

End Plates

Refer to *E32 Series* for details on Fiber Units.

Photoelectric Sensors Technical Guide

General Precautions

For precautions on individual products, refer to *Safety Precautions* in individual product information.

⚠ WARNING

These Sensors cannot be used in safety devices for presses or other safety devices used to protect human life. These Sensors are designed for use in applications for sensing workpieces and workers that do not affect safety.



Precautions for Safe Use

To ensure safety, always observe the following precautions.

● Wiring

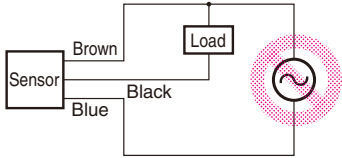
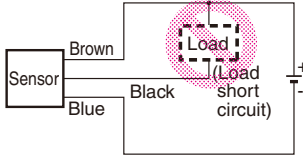
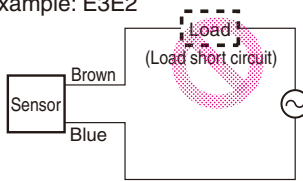
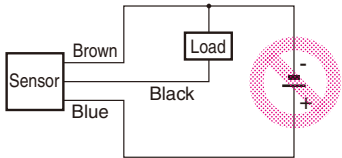
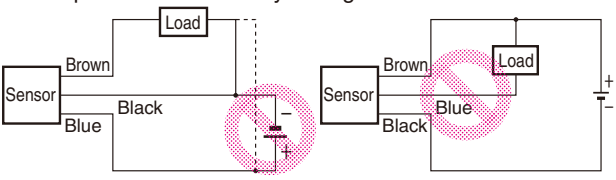
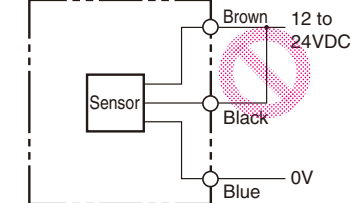
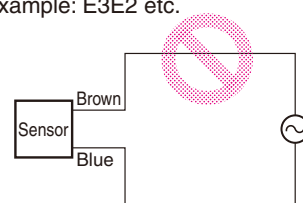
Item	Typical examples	
<p>Power Supply Voltage Do not use a voltage in excess of the operating voltage range. Applying a voltage in excess of the operating voltage range, or applying AC power (100 VAC or greater) to a DC Sensor may cause explosion or burning.</p>	<p>• DC Three-wire NPN Output Sensors</p> 	<p>---</p>
<p>Load Short-circuiting Do not short-circuit the load. Doing so may cause explosion or burning.</p>	<p>• DC Three-wire NPN Output Sensor</p> 	<p>• AC Two-wire Sensors Example: E3E2</p> 
<p>Incorrect Wiring Do not reverse the power supply polarity or otherwise wire incorrectly. Doing so may cause explosion or burning.</p>	<p>• DC Three-wire NPN Output Sensors Example: Incorrect Polarity</p> 	<p>• DC Three-wire NPN Output Sensors Example: Incorrect Polarity Wiring</p> 
<p>Connection without a load If the power supply is connected directly without a load, the internal elements may burst or burn. Be sure to insert a load when connecting the power supply.</p>	<p>• DC Three-wire NPN Output Sensors</p> 	<p>• AC 2-wire Sensors Example: E3E2 etc.</p> 

● Operating Environment

Do not use a Sensor in an environment where there are explosive or inflammable gases.

Photoelectric Sensors Technical Guide

Precautions for Correct Use

● Design

Power Reset Time

The Sensor will be ready to detect within approximately 100 ms after the power is turned ON.

If the Sensor and the load are connected to separate power supplies, turn ON the Sensor power before turning ON the load power. Any exceptions to this rule are indicated in *Safety Precautions* in individual product information.

Turning OFF Power

An output pulse may be generated when the power is turned OFF. It is recommended that the load or load line power be turned OFF before the Sensor power is turned OFF.

Power Supply Types

An unsmoothed full-wave or half-wave rectifying power supply cannot be used.

Mutual Interference

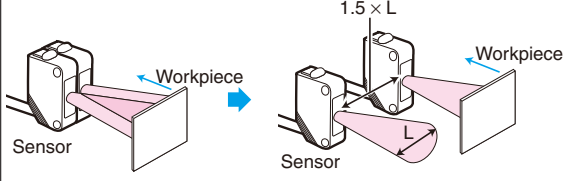
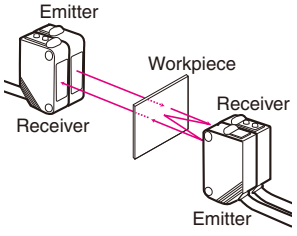
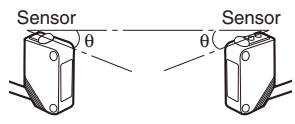

Mutual interference is a state where an output is unstable because the Sensors are affected by light from the adjacent Sensors. The following measures can be taken to avoid mutual interference.

Counter-measure	Concept	Through-beam Sensors	Reflective Sensors
1	Use a Sensor with the interference prevention function.	If Sensors are mounted in close proximity, use Sensors with the interference prevention function. 10 or fewer Sensors: E3X-DA□-S, E3X-MDA, E3C-LDA Fiber Sensors Performance, however, will depend on conditions. Refer to pages E3X-DA-S/E3X-MDA and E3C-LDA. 5 or fewer Sensors: E3X-NA Fiber Sensors 2 or fewer Sensors: E3T, E3Z, E3S-C, E3G-L1/L3, or E3S-C Built-in Amplifier Photoelectric Sensors (except Through-beam Sensors) E3C Photoelectric Sensor with separate amplifier	
2	Install an inference prevention filter.	A mutual interference prevention polarizing filter can be installed on only the E3Z-TA to allow close-proximity mounting of up to 2 Sensors. Mutual Interference Prevention Polarizing Filter: E39-E11	---
3	Separate Sensors to distance where interference does not occur.	Check the parallel movement distance range in the catalog, verify the set distance between adjacent Sensors, and install the Sensors accordingly at a distance at least 1.5 times the parallel movement distance range.	If the workpieces move from far to near, chattering may occur in the vicinity of the operating point. For this type of application, separate the Sensors by at least 1.5 times the operating range. 
4	Alternate Emitters and Receivers.	Close mounting of Sensors is possible by alternating the Emitters with the Receivers in a zigzag fashion (up to two Sensors). However, if the workpieces are close to the Photoelectric Sensors, light from the adjacent Emitter may be received and cause the Sensor to change to the incident light state. 	---
5	Offset the optical axes.	If there is a possibility that light from another Sensor may enter the Receiver, change the position of the Emitter and Receiver, place a light barrier between the Sensors, or take other measures to prevent the light from entering the Receiver. (Light may enter even if the Sensors are separated by more than the sensing distance.)	If Sensors are mounted in opposite each other, slant the Sensors as shown in the following diagram. (This is because the Sensors may affect each other and cause output chattering even if separated by more than the Sensor sensing distance.) 
6	Adjust the sensitivity.	Lowering the sensitivity will generally help.	

Photoelectric Sensors Technical Guide

Noise

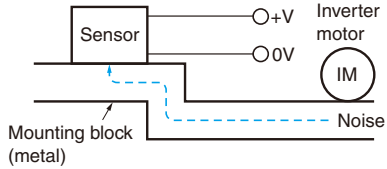
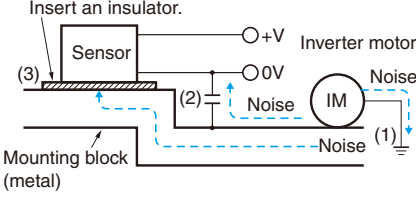
Countermeasures for noise depend on the path of noise entry, frequency components, and wave heights. Typical measures are as given in the following table.

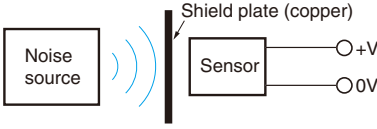
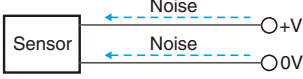
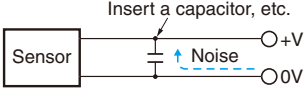
Type of noise	Noise intrusion path and countermeasure	
	Before countermeasure	After countermeasure
Common mode noise (inverter noise) (Common noise applied between the mounting block and the +V and 0-V lines, respectively.)	Noise enters from the noise source through the frame (metal). 	<ol style="list-style-type: none"> Ground the inverter motor (to 100 Ω or less) Ground the noise source and the power supply (0-V side) through a capacitor (film capacitor, 0.22 μF, 630 V). Insert an insulator (plastic, rubber, etc.) between the Sensor and the mounting plate (metal). 
Radiant noise (Ingress of high-frequency electromagnetic waves directly into Sensor, from power line, etc.)	Noise propagates through the air from the noise source and directly enters the Sensor. 	<ul style="list-style-type: none"> Insert a shield (copper) plate between the Sensor and the noise source e.g., a switching power supply). Separate the noise source and the Sensor to a distance where noise does not affect operation. 
Power line noise (Ingress of electromagnetic induction from high-voltage wires and switching noise from the switching power supply)	Noise enters from the power line. 	<ul style="list-style-type: none"> Insert a capacitor (e.g., a film capacitor), noise filter (e.g., ferrite core or insulated transformer), or varistor in the power line. 

● Wiring

Cable

Unless otherwise indicated, the maximum length of cable extension is 100 m using wire that is 0.3 mm² or greater.

Exceptions are indicated in **Safety Precautions** in individual product information.

Cable Tensile Strength

When wiring the cable, do not subject the cable to a tension greater than that indicated in the following table.

Cable diameter	Tensile strength
Less than 4 mm	30 N max.
4 mm or greater	50 N max.

Note: Do not subject a shielded cable or coaxial cable to tension.

Repeated Bending

Normally, the Sensor cable should not be bent repeatedly. (For bending-resistant cable, see **Attachment to Moving Parts** on page 24.)

Separation from High Voltage (Wiring Method)

Do not lay the cables for the Sensor together with high-voltage lines or power lines. Placing them in the same conduit or duct may cause damage or malfunction due to induction interference. As a general rule, wire the Sensor in a separate system, use an independent metal conduit, or use shielded cable.

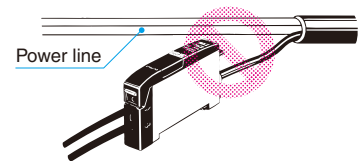

Work Required for Unconnected Leads

Unused leads for self-diagnosis outputs or other special functions should be cut and wrapped with insulating tape to prevent contact with other terminals.

Power Supply

When using a commercially available switching regulator, ground the FG (frame ground) and G (ground) terminals. If not grounded, switching noise in the power supply may cause malfunction.

Example of Connection with S3D2 Sensor Controller

DC Three-wire NPN Output Sensors

Reverse operation is possible using the signal input switch on the S3D2.

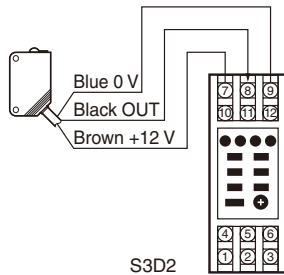

● Mounting

Attachment to Moving Parts

To mount the Photoelectric Sensor to a moving part, such as a robot hand, consider using a Sensors that uses a bending-resistant cable (robot cable).

Although the bending repetition tolerance of a standard cable is approximately 13,000 times, robot cable has an excellent bending tolerance of approximately 500,000 times.

Cable Bending Destruction Test (Tough Wire Breaking Test)

With current flowing, bending is repeated to check the number of bends until the current stops.

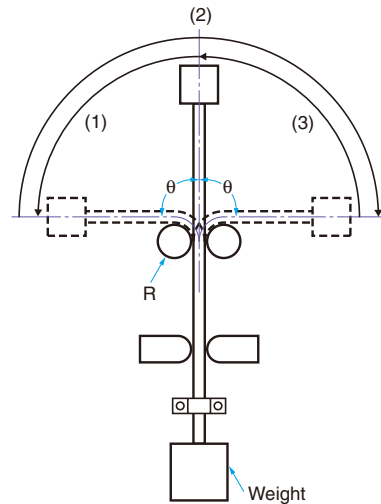

Specimen		Standard cable VR (H) 3 x18/0.12	Robot cable: Strong, conductive electrical wire 2 x 0.15 mm ² , shielded
Description/conditions	Bending angle (θ)	Left/right 90° each	Left/right 45° each
	Bending repetitions	---	60 bends/minute
	Weight	300g	200g
	Operation per bending	(1) through (3) in figure once	(1) through (3) in figure once
	Bending radius of support points (R)	5 mm	2.5 mm
Result		Approx. 13,000 times	Approx. 500,000 times

The testing conditions of the standard cable and robot cable are different.

Refer to the values in the above table to check bend-resistant performance under actual working conditions.

Photoelectric Sensors Technical Guide

Securing Fibers

The E3X Fiber Unit uses a one-touch locking mechanism. Use the following methods to attach and remove Fiber Units.

(1) Attaching Fibers

Open the protective cover, insert the fiber up to the insertion mark on the side of the Fiber Unit, and then lower the lock lever.

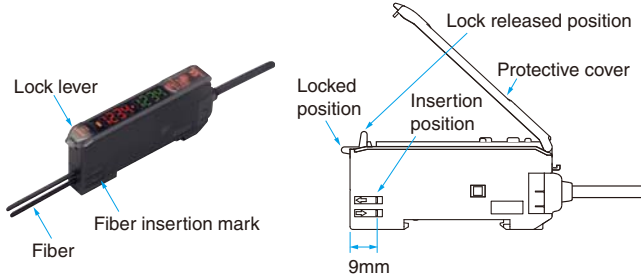

<Fiber Using the E39-F9 Attachment>

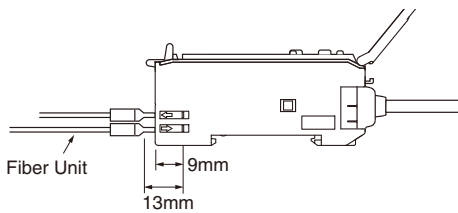

<Fibers That Cannot Be Free-cut (with Sleeves)>

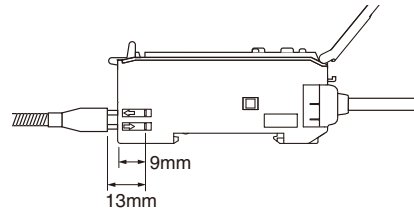

(2) Removing Fibers

Open the protective cover, lift up the lock lever, and pull out the fibers.

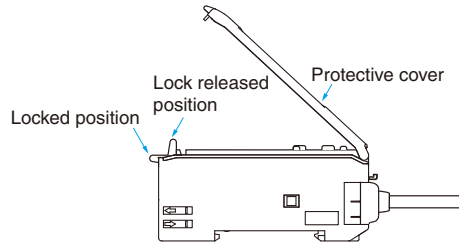

Note: 1. To maintain the fiber characteristics, make sure that the lock is released before removing the fibers.
2. Lock and unlock the fibers at an ambient temperature of -10 to 40°C .

● Adjustments

Optical Axis Adjustment

Move the Photoelectric Sensor both vertically and horizontally and set it in the center of the range in which the operation indicator is lit or not lit. For the E3S-C, the optical axis and the mechanical axis are the same, so the optical axis can be easily adjusted by aligning the mechanical axis.

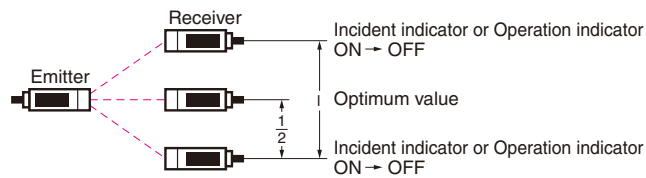

Optical axis: The axis from the center of the lens to the center of the beam for the Emitter and the axis from the center of the lens to the center of the reception area for the Receiver.

Mechanical axis: The axis perpendicular to the center of the lens.

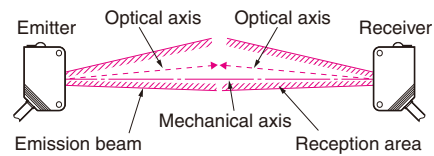

● Operating Environment

Water Resistance

Do not use in water, in rain, or outside.

Ambient Conditions

Do not use this Sensor in the following locations. Otherwise, it may malfunction or fail.

- (1) Locations exposed to excessive dust and dirt
- (2) Locations exposed to direct sunlight
- (3) Locations with corrosive gas vapors
- (4) Locations where organic solvents may splash onto the Sensor
- (5) Locations subject to vibration or shock
- (6) Locations where there is a possibility of direct contact with water, oil, or chemicals
- (7) Locations with high humidity and where condensation may result

Environmentally Resistive Sensors

The E32-T11F/T12F/T14F/T81F-S/D12F/D82F and E3HQ can be used in locations (3) and (6) above.

Optical Fiber Photoelectric Sensors in Explosive Gas Atmospheres

The Fiber Unit can be installed in the hazardous area, and the Amplifier Unit can be installed in a non-hazardous area.

<Reason>

For explosion or fire due to electrical equipment to occur, both the hazardous atmosphere and a source of ignition must be in the same location. Optical energy does not act as an ignition source, thus there is no danger of explosion or fire. The lens, case, and fiber covering are made of plastic, so this setup cannot be used if there is a possibility of contact with solvents that will corrode or degrade (e.g., cloud) the plastic.

<Ignition Source>

Electrical sparks or high-temperature parts that have sufficient energy to cause explosion in a hazardous atmosphere are called ignition sources.

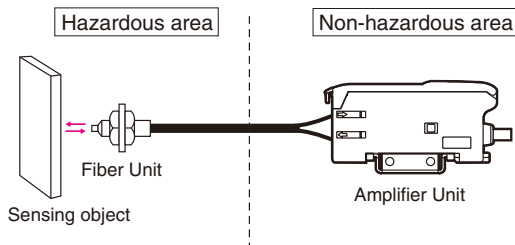

Influence from External Electrical Fields

Do not bring a transceiver near the Photoelectric Sensor or its wiring, because this may cause incorrect operation.

● Maintenance and Inspection

Points to Check When the Sensor Does Not Operate

- If the Sensor does not operate, check the following points.
 - (1) Are the wiring and connections correct?
 - (2) Are any of the mounting screws loose?
 - (3) Are the optical axis and sensitivity adjusted correctly?
 - (4) Do the sensing object and the workpiece speed satisfy the ratings and specifications?
 - (5) Are any foreign objects, such as debris or dust, adhering to the Emitter lens or Receiver lens?
 - (6) Is strong light, such as sunlight (e.g., reflected from a wall), shining on the Receiver?
 - (7) Do not attempt to disassemble or repair the Sensor under any circumstances.

Lens and Case

The lens and case of the Photoelectric Sensor are primarily made of plastic. Dirt should be gently wiped off with a dry cloth. Do not use thinner or other organic solvents.

- The case of the E3S-C is metal. The lens, however, is plastic.

● Accessories

Using a Reflector (E39-R3/R37/RS1/RS2/RS3)

During Application

- (1) When using adhesive tape on the rear face, apply it after washing away oil and dust with detergent. The Reflector cannot be mounted if there is any oil or dirt remaining.
- (2) Do not press on the E39-RS1/RS2/RS3 with metal or a fingernail. This may weaken performance.
- (3) This Sensor cannot be used in locations where oil or chemicals may splash on the Sensor.

M8 and M12 Connectors

- Be sure to connect or disconnect the connector after turning OFF the Sensor.
- Hold the connector cover to connect or disconnect the connector.
- Secure the connector cover by hand. Do not use pliers, otherwise the connector may be damaged.
- If the connector is not connected securely, the connector may be disconnected by vibration or the proper degree of protection of the Sensor may not be maintained.

● Others

Values Given in Typical Examples

The data and values given as typical examples are not ratings and performance and do not indicate specified performance. They are rather values from samples taken from production lots, and are provided for reference as guidelines. Typical examples include the minimum sensing object, engineering data, step (height) detection data, and selection list for specifications.

Cleaning

- Keep organic solvents away from the Sensor. Organic solvents will dissolve the surface.
- Use a soft, dry cloth to clean the Sensor.

Read and Understand This Catalog

Please read and understand this catalog before purchasing the products. Please consult your OMRON representative if you have any questions or comments.

Warranty and Limitations of Liability

WARRANTY

OMRON's exclusive warranty is that the products are free from defects in materials and workmanship for a period of one year (or other period if specified) from date of sale by OMRON.

OMRON MAKES NO WARRANTY OR REPRESENTATION, EXPRESS OR IMPLIED, REGARDING NON-INFRINGEMENT, MERCHANTABILITY, OR FITNESS FOR PARTICULAR PURPOSE OF THE PRODUCTS. ANY BUYER OR USER ACKNOWLEDGES THAT THE BUYER OR USER ALONE HAS DETERMINED THAT THE PRODUCTS WILL SUITABLY MEET THE REQUIREMENTS OF THEIR INTENDED USE. OMRON DISCLAIMS ALL OTHER WARRANTIES, EXPRESS OR IMPLIED.

LIMITATIONS OF LIABILITY

OMRON SHALL NOT BE RESPONSIBLE FOR SPECIAL, INDIRECT, OR CONSEQUENTIAL DAMAGES, LOSS OF PROFITS, OR COMMERCIAL LOSS IN ANY WAY CONNECTED WITH THE PRODUCTS, WHETHER SUCH CLAIM IS BASED ON CONTRACT, WARRANTY, NEGLIGENCE, OR STRICT LIABILITY.

In no event shall responsibility of OMRON for any act exceed the individual price of the product on which liability is asserted.

IN NO EVENT SHALL OMRON BE RESPONSIBLE FOR WARRANTY, REPAIR, OR OTHER CLAIMS REGARDING THE PRODUCTS UNLESS OMRON'S ANALYSIS CONFIRMS THAT THE PRODUCTS WERE PROPERLY HANDLED, STORED, INSTALLED, AND MAINTAINED AND NOT SUBJECT TO CONTAMINATION, ABUSE, MISUSE, OR INAPPROPRIATE MODIFICATION OR REPAIR.

Application Considerations

SUITABILITY FOR USE

OMRON shall not be responsible for conformity with any standards, codes, or regulations that apply to the combination of products in the customer's application or use of the product.

At the customer's request, OMRON will provide applicable third party certification documents identifying ratings and limitations of use that apply to the products. This information by itself is not sufficient for a complete determination of the suitability of the products in combination with the end product, machine, system, or other application or use.

The following are some examples of applications for which particular attention must be given. This is not intended to be an exhaustive list of all possible uses of the products, nor is it intended to imply that the uses listed may be suitable for the products:

- Outdoor use, uses involving potential chemical contamination or electrical interference, or conditions or uses not described in this catalog.
- Nuclear energy control systems, combustion systems, railroad systems, aviation systems, medical equipment, amusement machines, vehicles, safety equipment, and installations subject to separate industry or government regulations.
- Systems, machines, and equipment that could present a risk to life or property.

Please know and observe all prohibitions of use applicable to the products.

NEVER USE THE PRODUCTS FOR AN APPLICATION INVOLVING SERIOUS RISK TO LIFE OR PROPERTY WITHOUT ENSURING THAT THE SYSTEM AS A WHOLE HAS BEEN DESIGNED TO ADDRESS THE RISKS, AND THAT THE OMRON PRODUCT IS PROPERLY RATED AND INSTALLED FOR THE INTENDED USE WITHIN THE OVERALL EQUIPMENT OR SYSTEM.

Disclaimers

CHANGE IN SPECIFICATIONS

Product specifications and accessories may be changed at any time based on improvements and other reasons.

It is our practice to change model numbers when published ratings or features are changed, or when significant construction changes are made. However, some specifications of the product may be changed without any notice. When in doubt, special model numbers may be assigned to fix or establish key specifications for your application on your request. Please consult with your OMRON representative at any time to confirm actual specifications of purchased product.

DIMENSIONS AND WEIGHTS

Dimensions and weights are nominal and are not to be used for manufacturing purposes, even when tolerances are shown.

ERRORS AND OMISSIONS

The information in this catalog has been carefully checked and is believed to be accurate; however, no responsibility is assumed for clerical, typographical, or proofreading errors, or omissions.

PERFORMANCE DATA

Performance data given in this catalog is provided as a guide for the user in determining suitability and does not constitute a warranty. It may represent the result of OMRON's test conditions, and the users must correlate it to actual application requirements. Actual performance is subject to the OMRON Warranty and Limitations of Liability.

PROGRAMMABLE PRODUCTS

OMRON shall not be responsible for the user's programming of a programmable product, or any consequence thereof.

COPYRIGHT AND COPY PERMISSION

This catalog shall not be copied for sales or promotions without permission.

This catalog is protected by copyright and is intended solely for use in conjunction with the product. Please notify us before copying or reproducing this catalog in any manner, for any other purpose. If copying or transmitting this catalog to another, please copy or transmit it in its entirety.



Компания «ЭлектроПласт» предлагает заключение долгосрочных отношений при поставках импортных электронных компонентов на взаимовыгодных условиях!

Наши преимущества:

- Оперативные поставки широкого спектра электронных компонентов отечественного и импортного производства напрямую от производителей и с крупнейших мировых складов;
- Поставка более 17-ти миллионов наименований электронных компонентов;
- Поставка сложных, дефицитных, либо снятых с производства позиций;
- Оперативные сроки поставки под заказ (от 5 рабочих дней);
- Экспресс доставка в любую точку России;
- Техническая поддержка проекта, помощь в подборе аналогов, поставка прототипов;
- Система менеджмента качества сертифицирована по Международному стандарту ISO 9001;
- Лицензия ФСБ на осуществление работ с использованием сведений, составляющих государственную тайну;
- Поставка специализированных компонентов (Xilinx, Altera, Analog Devices, Intersil, Interpoint, Microsemi, Aeroflex, Peregrine, Syfer, Eurofarad, Texas Instrument, Miteq, Cobham, E2V, MA-COM, Hittite, Mini-Circuits, General Dynamics и др.);

Помимо этого, одним из направлений компании «ЭлектроПласт» является направление «Источники питания». Мы предлагаем Вам помощь Конструкторского отдела:

- Подбор оптимального решения, техническое обоснование при выборе компонента;
- Подбор аналогов;
- Консультации по применению компонента;
- Поставка образцов и прототипов;
- Техническая поддержка проекта;
- Защита от снятия компонента с производства.



Как с нами связаться

Телефон: 8 (812) 309 58 32 (многоканальный)

Факс: 8 (812) 320-02-42

Электронная почта: org@eplast1.ru

Адрес: 198099, г. Санкт-Петербург, ул. Калинина, дом 2, корпус 4, литера А.