

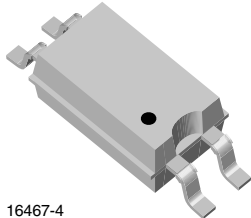

## Optocoupler, Phototransistor Output, AC Input, Low Input Current, SSOP-4, Half Pitch, Mini-Flat Package

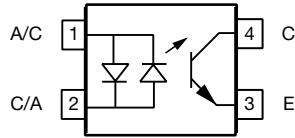

16467-4



### FEATURES

- High CTR with low input current
- Low profile package (half pitch)
- High collector emitter voltage,  $V_{CE0} = 80\text{ V}$
- Isolation test voltage,  $3750\text{ V}_{RMS}$
- Low coupling capacitance
- High common mode transient immunity
- Compliant to RoHS Directive 2002/95/EC and in accordance to WEEE 2002/96/EC



RoHS COMPLIANT

### DESCRIPTION

The VOS628A series has a GaAs infrared emitting diode emitter, which is optically coupled to a silicon planar phototransistor detector, and is incorporated in a 4-pin 50 mil lead pitch mini-flat package.

It features a high current transfer ratio at low input current, low coupling capacitance, and high isolation voltage.

The coupling devices are designed for signal transmission between two electrically separated circuits.

### APPLICATIONS

- Telecom
- Industrial controls
- Battery powered equipment
- Office machines
- Programmable controllers

### AGENCY APPROVALS

- UL1577, file no. E76222 system code M, double protection (pending)
- cUL CSA 22.2 bulletin 5A, double protection (pending)
- DIN EN 60747-5-2 (pending) (VDE 0884)/DIN EN 60747-5-5 available with option 1
- BSI: EN 60065:2002 (pending), EN 60950-1:2006 (pending)
- FIMKO

| ORDERING INFORMATION     |            |                |               |
|--------------------------|------------|----------------|---------------|
| V                        | O          | S              | 6             |
| 2                        | 8          | A              | -             |
| #                        | X          | 0              | 0             |
| 1                        | T          |                |               |
| PART NUMBER              |            |                | CTR BIN       |
|                          |            | PACKAGE OPTION | TAPE AND REEL |
|                          |            |                | SSOP-#        |
|                          |            |                | 7 mm          |
| AGENCY CERTIFIED/PACKAGE | CTR (%)    |                |               |
|                          | ± 1 mA     |                |               |
| UL, cUL, BSI             | 63 to 125  | 100 to 200     | 160 to 320    |
| SSOP-4, 50 mil pitch     | VOS628A-2T | VOS628A-3T     | VOS628A-4T    |
| UL, cUL, BSI, VDE        | 63 to 125  | 100 to 200     | 160 to 320    |
| SSOP-4, 50 mil pitch     | -          | VOS628A-3X001T | -             |

### Note

- Additional options may be possible, please contact sales office.



| ABSOLUTE MAXIMUM RATINGS ( $T_{amb} = 25\text{ }^{\circ}\text{C}$ , unless otherwise specified) |   |            |                |                    |
|---|---|------------|----------------|--------------------|
| PARAMETER   | TEST CONDITION  | SYMBOL     | VALUE          | UNIT               |
| <b>INPUT</b>  |   |            |                |                    |
| Power dissipation   |   | $P_{diss}$ | 100            | mW                 |
| Forward current   |   | $I_F$      | 60             | mA                 |
| <b>OUTPUT</b>   |   |            |                |                    |
| Collector emitter voltage   |   | $V_{CE}$   | 80             | V                  |
| Emitter collector voltage   |   | $V_{EC}$   | 7              | V                  |
| Collector current   |   | $I_C$      | 50             | mA                 |
|   | $t_p/T = 0.5$ , $t_p < 10\text{ ms}$                                    | $I_C$      | 100            | mA                 |
| Power dissipation   |   | $P_{diss}$ | 150            | mW                 |
| <b>COUPLER</b>  |   |            |                |                    |
| Isolation test voltage between emitter and detector   |   | $V_{ISO}$  | 3750           | $V_{RMS}$          |
| Isolation resistance  | $V_{IO} = 500\text{ V}$ , $T_{amb} = 25\text{ }^{\circ}\text{C}$        | $R_{IO}$   | $\geq 10^{12}$ | $\Omega$           |
|   | $V_{IO} = 500\text{ V}$ , $T_{amb} = 100\text{ }^{\circ}\text{C}$       | $R_{IO}$   | $\geq 10^{11}$ | $\Omega$           |
| Storage temperature range   |   | $T_{stg}$  | - 40 to + 125  | $^{\circ}\text{C}$ |
| Ambient temperature range   |   | $T_{amb}$  | - 40 to + 110  | $^{\circ}\text{C}$ |
| Junction temperature  |   | $T_j$      | 125            | $^{\circ}\text{C}$ |
| Soldering temperature <sup>(1)</sup>  | max. 10 s, dip soldering distance to seating plane $\geq 1.5\text{ mm}$ | $T_{sld}$  | 260            | $^{\circ}\text{C}$ |

**Notes**

- Stresses in excess of the absolute maximum ratings can cause permanent damage to the device. Functional operation of the device is not implied at these or any other conditions in excess of those given in the operational sections of this document. Exposure to absolute maximum ratings for extended periods of the time can adversely affect reliability.
- <sup>(1)</sup> Refer to reflow profile for soldering conditions for surface mounted devices.

| ELECTRICAL CHARACTERISTICS ( $T_{amb} = 25\text{ }^{\circ}\text{C}$ , unless otherwise specified) |  |           |             |      |      |      |      |
|---|--|-----------|-------------|------|------|------|------|
| PARAMETER   | TEST CONDITION                                   | PART      | SYMBOL      | MIN. | TYP. | MAX. | UNIT |
| <b>INPUT</b>  |  |           |             |      |      |      |      |
| Forward voltage   | $I_F = \pm 5\text{ mA}$                          |           | $V_F$       |      | 1.16 | 1.5  | V    |
| Capacitance   | $V_R = 0\text{ V}$ , $f = 1\text{ MHz}$          |           | $C_O$       |      | 25   |      | pF   |
| <b>OUTPUT</b>   |  |           |             |      |      |      |      |
| Collector emitter leakage current   | $V_{CE} = 10\text{ V}$                           |           | $I_{CEO}$   |      | 10   | 200  | nA   |
| Collector emitter capacitance   | $V_{CE} = 5\text{ V}$ , $f = 1\text{ MHz}$       |           | $C_{CE}$    |      | 7    |      | pF   |
| <b>COUPLER</b>  |  |           |             |      |      |      |      |
| Collector emitter saturation voltage  | $I_C = 0.32\text{ mA}$ , $I_F = \pm 1\text{ mA}$ | VOS628A-2 | $V_{CEsat}$ |      | 0.25 | 0.4  | V    |
|   | $I_C = 0.5\text{ mA}$ , $I_F = \pm 1\text{ mA}$  | VOS628A-3 | $V_{CEsat}$ |      | 0.25 | 0.4  | V    |
|   | $I_C = 0.8\text{ mA}$ , $I_F = \pm 1\text{ mA}$  | VOS628A-4 | $V_{CEsat}$ |      | 0.25 | 0.4  | V    |
| Coupling capacitance  |  |           | $C_C$       |      | 0.25 |      | pF   |

**Note**

- Minimum and maximum values are testing requirements. Typical values are characteristics of the device and are the result of engineering evaluation. Typical values are for information only and are not part of the testing requirements.

| CURRENT TRANSFER RATIO ( $T_{amb} = 25\text{ }^{\circ}\text{C}$ , unless otherwise specified) |   |           |        |      |      |      |      |
|---|---|-----------|--------|------|------|------|------|
| PARAMETER   | TEST CONDITION                                  | PART      | SYMBOL | MIN. | TYP. | MAX. | UNIT |
| $I_C/I_F$   | $I_F = \pm 1\text{ mA}$ , $V_{CE} = 5\text{ V}$ | VOS628A-2 | CTR    | 63   |      | 125  | %    |
|   |   | VOS628A-3 | CTR    | 100  |      | 200  | %    |
|   |   | VOS628A-4 | CTR    | 160  |      | 320  | %    |

| SWITCHING CHARACTERISTICS ( $T_{amb} = 25\text{ }^{\circ}\text{C}$ , unless otherwise specified) |   |           |      |      |      |               |
|--|---|-----------|------|------|------|---------------|
| PARAMETER  | TEST CONDITION  | SYMBOL    | MIN. | TYP. | MAX. | UNIT          |
| Turn on time   | $V_{CC} = 5\text{ V}$ , $I_C = 2\text{ mA}$ , $R_L = 100\ \Omega$ | $t_{on}$  |      | 6    |      | $\mu\text{s}$ |
| Rise time  | $V_{CC} = 5\text{ V}$ , $I_C = 2\text{ mA}$ , $R_L = 100\ \Omega$ | $t_r$     |      | 3.5  |      | $\mu\text{s}$ |
| Turn off time  | $V_{CC} = 5\text{ V}$ , $I_C = 2\text{ mA}$ , $R_L = 100\ \Omega$ | $t_{off}$ |      | 5.5  |      | $\mu\text{s}$ |
| Fall time  | $V_{CC} = 5\text{ V}$ , $I_C = 2\text{ mA}$ , $R_L = 100\ \Omega$ | $t_f$     |      | 5    |      | $\mu\text{s}$ |

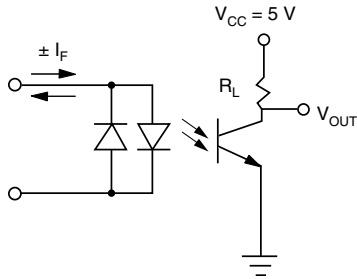

Fig. 1 - Test Circuit

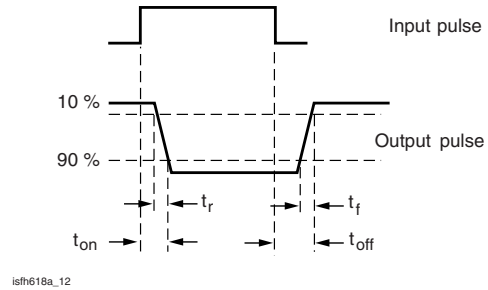

Fig. 2 - Test Circuit and Waveforms

| SAFETY AND INSULATION RATINGS                        |   |        |      |           |      |                    |
|--|---|--------|------|-----------|------|--------------------|
| PARAMETER  | TEST CONDITION                          | SYMBOL | MIN. | TYP.      | MAX. | UNIT               |
| Climatic classification (according to IEC 68 part 1) |   |        |      | 40/110/21 |      |                    |
| Comparative tracking index                           |   | CTI    | 175  |           | 399  |                    |
| $V_{IOTM}$   |   |        | 6000 |           |      | $V_{peak}$         |
| $V_{IORM}$   |   |        | 707  |           |      | $V_{peak}$         |
| $P_{SO}$   |   |        |      |           | 265  | mW                 |
| $I_{SI}$   |   |        |      |           | 130  | mA                 |
| $T_{SI}$   |   |        |      |           | 150  | $^{\circ}\text{C}$ |
| Creepage distance                                    |   |        | 5    |           |      | mm                 |
| Clearance distance                                   |   |        | 5    |           |      | mm                 |
| Insulation thickness                                 | Reinforce rated, per IEC 60950 2.10.5.1 |        | 0.4  |           |      | mm                 |

**Note**

- As per IEC 60747-5-2, §7.4.3.8.1, this optocoupler is suitable for “safe electrical insulation” only within the safety ratings. Compliance with the safety ratings shall be ensured by means of protective circuits.

**TYPICAL CHARACTERISTICS** ( $T_{amb} = 25\text{ }^{\circ}\text{C}$ , unless otherwise specified)

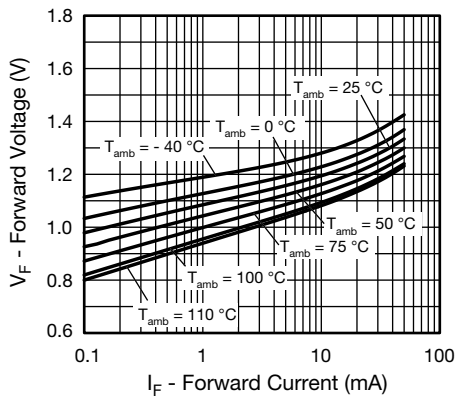

Fig. 3 - Forward Voltage vs. Forward Current

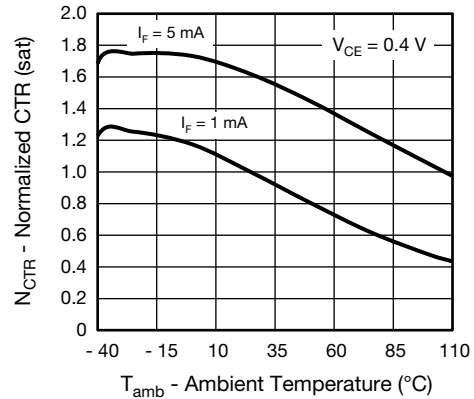

Fig. 6 - Normalized CTR (sat) vs. Ambient Temperature

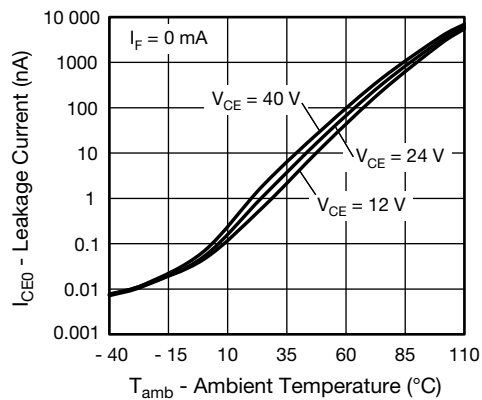

Fig. 4 - Leakage Current vs. Ambient Temperature

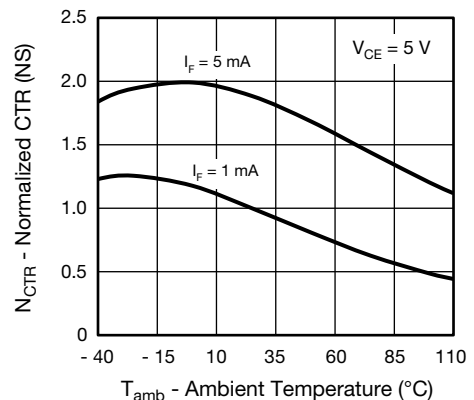

Fig. 7 - Normalized CTR (NS) vs. Ambient Temperature

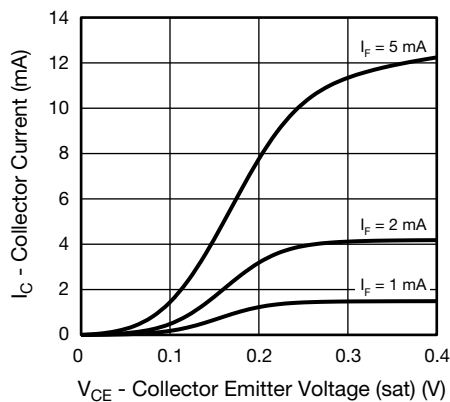

Fig. 5 - Collector Current vs. Collector Emitter Voltage (sat)

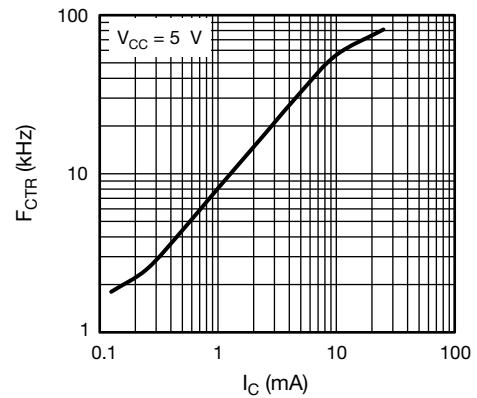

Fig. 8 -  $F_{CTR}$  vs.  $I_C$

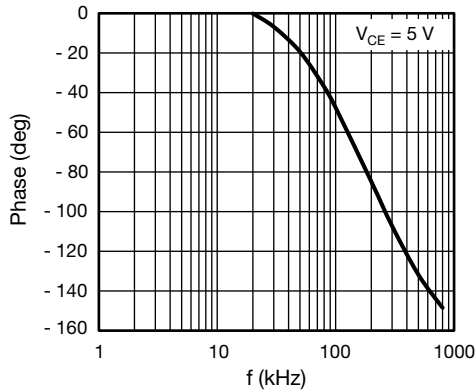
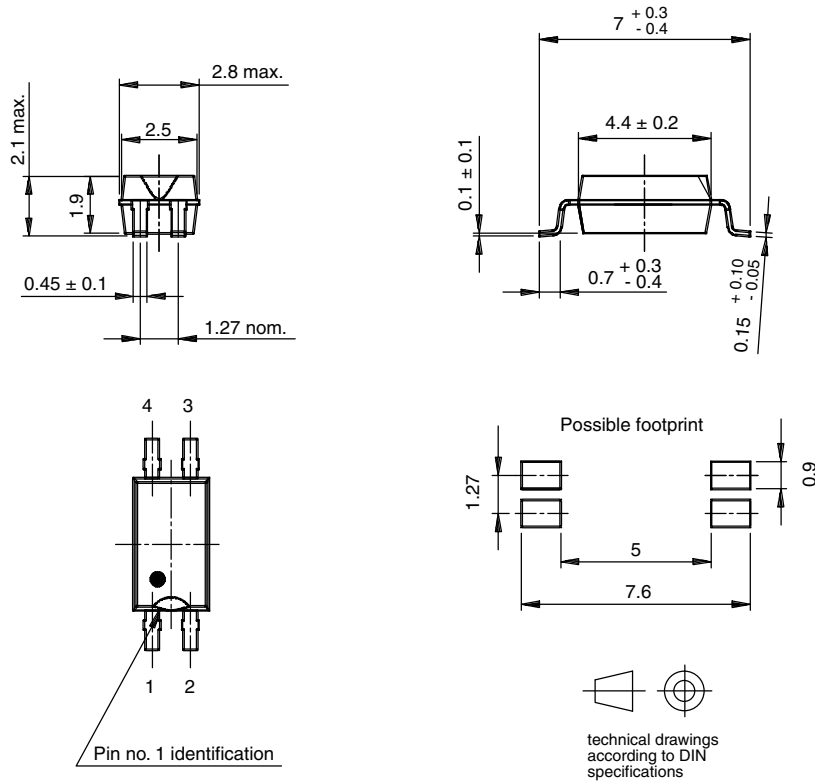

Fig. 9 - F<sub>CTR</sub> vs. Phase Angle

**PACKAGE DIMENSIONS** in millimeters



16283

**PACKAGE MARKING** (example)

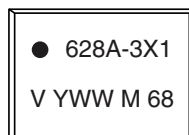

**Notes**

- Only option 1 is reflected in the package marking, it is indicated by the characters "X1".
- Tape and reel suffix (T) is not part of the package marking.



## Disclaimer

ALL PRODUCT, PRODUCT SPECIFICATIONS AND DATA ARE SUBJECT TO CHANGE WITHOUT NOTICE TO IMPROVE RELIABILITY, FUNCTION OR DESIGN OR OTHERWISE.

Vishay Intertechnology, Inc., its affiliates, agents, and employees, and all persons acting on its or their behalf (collectively, "Vishay"), disclaim any and all liability for any errors, inaccuracies or incompleteness contained in any datasheet or in any other disclosure relating to any product.

Vishay makes no warranty, representation or guarantee regarding the suitability of the products for any particular purpose or the continuing production of any product. To the maximum extent permitted by applicable law, Vishay disclaims (i) any and all liability arising out of the application or use of any product, (ii) any and all liability, including without limitation special, consequential or incidental damages, and (iii) any and all implied warranties, including warranties of fitness for particular purpose, non-infringement and merchantability.

Statements regarding the suitability of products for certain types of applications are based on Vishay's knowledge of typical requirements that are often placed on Vishay products in generic applications. Such statements are not binding statements about the suitability of products for a particular application. It is the customer's responsibility to validate that a particular product with the properties described in the product specification is suitable for use in a particular application. Parameters provided in datasheets and/or specifications may vary in different applications and performance may vary over time. All operating parameters, including typical parameters, must be validated for each customer application by the customer's technical experts. Product specifications do not expand or otherwise modify Vishay's terms and conditions of purchase, including but not limited to the warranty expressed therein.

Except as expressly indicated in writing, Vishay products are not designed for use in medical, life-saving, or life-sustaining applications or for any other application in which the failure of the Vishay product could result in personal injury or death. Customers using or selling Vishay products not expressly indicated for use in such applications do so at their own risk and agree to fully indemnify and hold Vishay and its distributors harmless from and against any and all claims, liabilities, expenses and damages arising or resulting in connection with such use or sale, including attorneys fees, even if such claim alleges that Vishay or its distributor was negligent regarding the design or manufacture of the part. Please contact authorized Vishay personnel to obtain written terms and conditions regarding products designed for such applications.

No license, express or implied, by estoppel or otherwise, to any intellectual property rights is granted by this document or by any conduct of Vishay. Product names and markings noted herein may be trademarks of their respective owners.



Компания «ЭлектроПласт» предлагает заключение долгосрочных отношений при поставках импортных электронных компонентов на взаимовыгодных условиях!

Наши преимущества:

- Оперативные поставки широкого спектра электронных компонентов отечественного и импортного производства напрямую от производителей и с крупнейших мировых складов;
- Поставка более 17-ти миллионов наименований электронных компонентов;
- Поставка сложных, дефицитных, либо снятых с производства позиций;
- Оперативные сроки поставки под заказ (от 5 рабочих дней);
- Экспресс доставка в любую точку России;
- Техническая поддержка проекта, помощь в подборе аналогов, поставка прототипов;
- Система менеджмента качества сертифицирована по Международному стандарту ISO 9001;
- Лицензия ФСБ на осуществление работ с использованием сведений, составляющих государственную тайну;
- Поставка специализированных компонентов (Xilinx, Altera, Analog Devices, Intersil, Interpoint, Microsemi, Aeroflex, Peregrine, Syfer, Eurofarad, Texas Instrument, Miteq, Cobham, E2V, MA-COM, Hittite, Mini-Circuits, General Dynamics и др.);

Помимо этого, одним из направлений компании «ЭлектроПласт» является направление «Источники питания». Мы предлагаем Вам помощь Конструкторского отдела:

- Подбор оптимального решения, техническое обоснование при выборе компонента;
- Подбор аналогов;
- Консультации по применению компонента;
- Поставка образцов и прототипов;
- Техническая поддержка проекта;
- Защита от снятия компонента с производства.



#### Как с нами связаться

**Телефон:** 8 (812) 309 58 32 (многоканальный)

**Факс:** 8 (812) 320-02-42

**Электронная почта:** [org@eplast1.ru](mailto:org@eplast1.ru)

**Адрес:** 198099, г. Санкт-Петербург, ул. Калинина, дом 2, корпус 4, литера А.