

OptiMOS™ Power-MOSFET
Features

- Optimized for 5V driver application (Notebook, VGA, POL)
- Low FOM_{SW} for High Frequency SMPS
- 100% avalanche tested
- Improved switching behaviour
- N-channel
- Very low on-resistance $R_{DS(on)}$ @ $V_{GS}=4.5\text{ V}$
- Excellent gate charge x $R_{DS(on)}$ product (FOM)
- Qualified according to JEDEC¹⁾ for target applications
- Superior thermal resistance
- Pb-free plating; RoHS compliant
- Halogen-free according to IEC61249-2-21

Product Summary

V_{DS}		34	V
$R_{DS(on),max}$	$V_{GS}=10\text{ V}$	12	mΩ
	$V_{GS}=4.5\text{ V}$	15	
I_D		36	A

PG-TSDSON-8

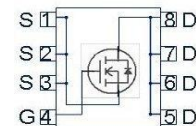

Type	Package	Marking
BSZ0909NS	PG-TSDSON-8	0909NS

Maximum ratings, at $T_j=25\text{ °C}$, unless otherwise specified

Parameter	Symbol	Conditions	Value	Unit
Continuous drain current	I_D	$V_{GS}=10\text{ V}, T_C=25\text{ °C}$	36	A
		$V_{GS}=10\text{ V}, T_C=100\text{ °C}$	23	
		$V_{GS}=4.5\text{ V}, T_C=25\text{ °C}$	32	
		$V_{GS}=4.5\text{ V}, T_C=100\text{ °C}$	21	
		$V_{GS}=4.5\text{ V}, T_A=25\text{ °C}, R_{thJA}=60\text{ K/W}^2)$	9	
Pulsed drain current ³⁾	$I_{D,pulse}$	$T_C=25\text{ °C}$	144	
Avalanche current, single pulse ⁴⁾	I_{AS}	$T_C=25\text{ °C}$	20	
Avalanche energy, single pulse	E_{AS}	$I_D=20\text{ A}, R_{GS}=25\text{ Ω}$	9	mJ
Gate source voltage	V_{GS}		±20	V

¹⁾ J-STD20 and JESD22

Maximum ratings, at $T_j=25\text{ °C}$, unless otherwise specified

Parameter	Symbol	Conditions	Value	Unit
Power dissipation	P_{tot}	$T_C=25\text{ °C}$	25	W
		$T_A=25\text{ °C}$, $R_{\text{thJA}}=60\text{ K/W}^2)$	2.1	
Operating and storage temperature	T_j, T_{stg}		-55 ... 150	°C
IEC climatic category; DIN IEC 68-1			55/150/56	

Parameter	Symbol	Conditions	Values			Unit
			min.	typ.	max.	

Thermal characteristics

Thermal resistance, junction - case	R_{thJC}		-	-	5.1	K/W
Device on PCB	R_{thJA}	6 cm ² cooling area ²⁾	-	-	60	

Electrical characteristics, at $T_j=25\text{ °C}$, unless otherwise specified

Static characteristics

Drain-source breakdown voltage	$V_{(\text{BR})\text{DSS}}$	$V_{\text{GS}}=0\text{ V}$, $I_{\text{D}}=1\text{ mA}$	34	-	-	V
Gate threshold voltage	$V_{\text{GS(th)}}$	$V_{\text{DS}}=V_{\text{GS}}$, $I_{\text{D}}=250\text{ }\mu\text{A}$	1.2	-	2	
Zero gate voltage drain current	I_{DSS}	$V_{\text{DS}}=34\text{ V}$, $V_{\text{GS}}=0\text{ V}$, $T_j=25\text{ °C}$	-	0.1	1	μA
		$V_{\text{DS}}=34\text{ V}$, $V_{\text{GS}}=0\text{ V}$, $T_j=125\text{ °C}$	-	10	100	
Gate-source leakage current	I_{GSS}	$V_{\text{GS}}=16\text{ V}$, $V_{\text{DS}}=0\text{ V}$	-	10	100	nA
Drain-source on-state resistance	$R_{\text{DS(on)}}$	$V_{\text{GS}}=4.5\text{ V}$, $I_{\text{D}}=12\text{ A}$	-	12.0	15	m Ω
		$V_{\text{GS}}=10\text{ V}$, $I_{\text{D}}=20\text{ A}$	-	10.0	12.0	
Gate resistance	R_{G}		1.5	3.0	6.0	Ω
Transconductance	g_{fs}	$ V_{\text{DS}} >2 I_{\text{D}} R_{\text{DS(on)max}}$, $I_{\text{D}}=30\text{ A}$	24	47	-	S

²⁾ Device on 40 mm x 40 mm x 1.5 mm epoxy PCB FR4 with 6 cm² (one layer, 70 μm thick) copper area for drain connection. PCB is vertical in still air.

³⁾ See figure 3 for more detailed information

Parameter	Symbol	Conditions	Values			Unit
			min.	typ.	max.	

Dynamic characteristics

Input capacitance	C_{iss}	$V_{GS}=0\text{ V}, V_{DS}=15\text{ V},$ $f=1\text{ MHz}$	-	975	1310	pF
Output capacitance	C_{oss}		-	340	450	
Reverse transfer capacitance	C_{rss}		-	21	-	
Turn-on delay time	$t_{d(on)}$	$V_{DD}=15\text{ V}, V_{GS}=10\text{ V},$ $I_D=30\text{ A}, R_{G,ext}=1.6\ \Omega$	-	4.5	-	ns
Rise time	t_r		-	2.2	-	
Turn-off delay time	$t_{d(off)}$		-	16	-	
Fall time	t_f		-	2.0	-	

Gate Charge Characteristics⁵⁾

Gate to source charge	Q_{gs}	$V_{DD}=15\text{ V}, I_D=30\text{ A},$ $V_{GS}=0\text{ to }4.5\text{ V}$	-	3.3	4.4	nC
Gate charge at threshold	$Q_{g(th)}$		-	1.5	-	
Gate to drain charge	Q_{gd}		-	1.6	2.1	
Switching charge	Q_{sw}		-	3.2	-	
Gate charge total	Q_g		-	6.1	8.1	
Gate plateau voltage	$V_{plateau}$		-	3.4	-	V
Gate charge total	Q_g	$V_{DD}=15\text{ V}, I_D=30\text{ A},$ $V_{GS}=0\text{ to }10\text{ V}$	-	13	17	nC
Gate charge total, sync. FET	$Q_{g(sync)}$	$V_{DS}=0.1\text{ V},$ $V_{GS}=0\text{ to }4.5\text{ V}$	-	5.3	-	
Output charge	Q_{oss}	$V_{DD}=15\text{ V}, V_{GS}=0\text{ V}$	-	8.9	12	

Reverse Diode

Diode continuous forward current	I_S	$T_C=25\text{ }^\circ\text{C}$	-	-	23	A
Diode pulse current	$I_{S,pulse}$		-	-	148	
Diode forward voltage	V_{SD}	$V_{GS}=0\text{ V}, I_F=20\text{ A},$ $T_j=25\text{ }^\circ\text{C}$	-	0.9	-	V
Reverse recovery charge	Q_{rr}	$V_R=15\text{ V}, I_F=I_S,$ $di_F/dt=400\text{ A}/\mu\text{s}$	-	-	10	nC

⁴⁾ See figure 13 for more detailed information

⁵⁾ See figure 16 for gate charge parameter definition

1 Power dissipation

$$P_{tot}=f(T_C)$$

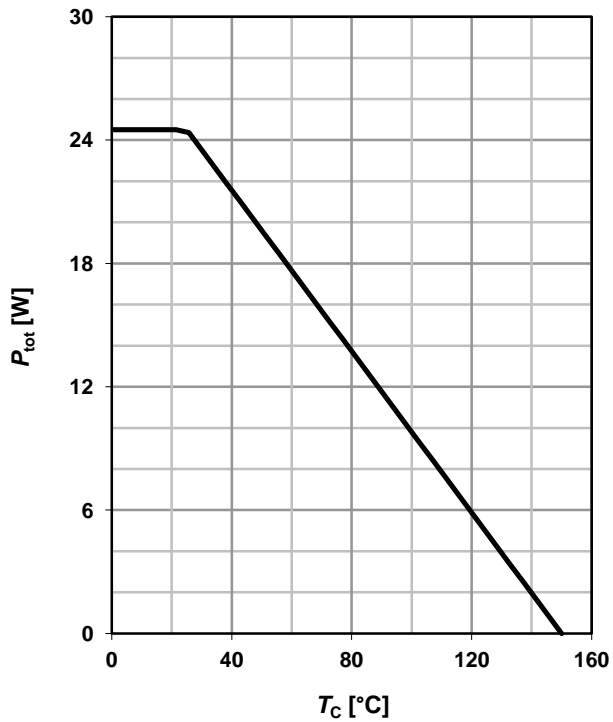

2 Drain current

$$I_D=f(T_C)$$

parameter: V_{GS}

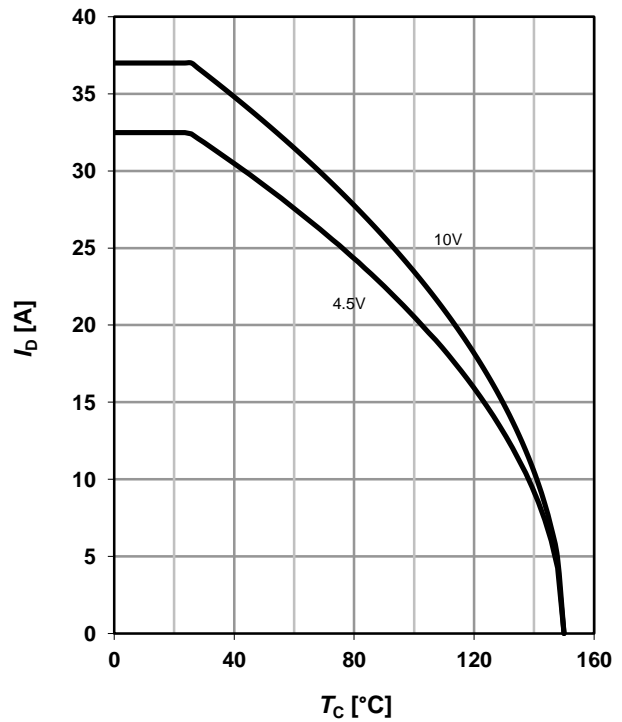

3 Safe operating area

$$I_D=f(V_{DS}); T_C=25\text{ °C}; D=0$$

parameter: t_p

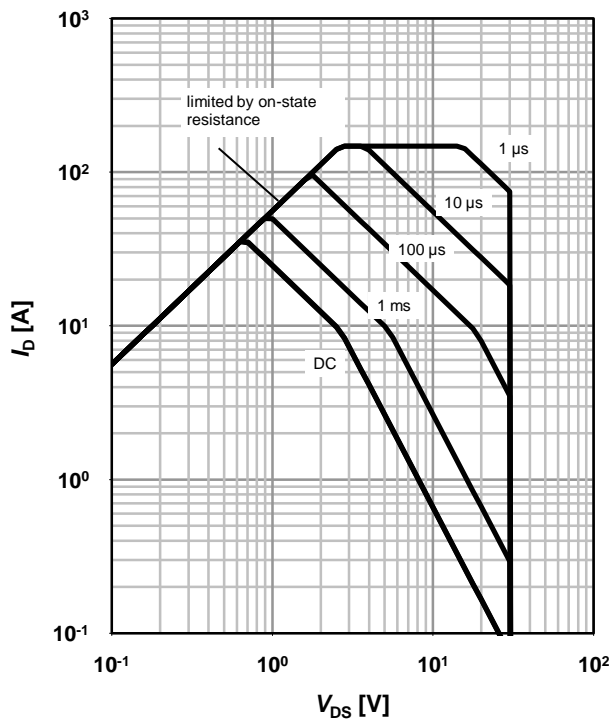

4 Max. transient thermal impedance

$$Z_{thJC}=f(t_p)$$

parameter: $D=t_p/T$

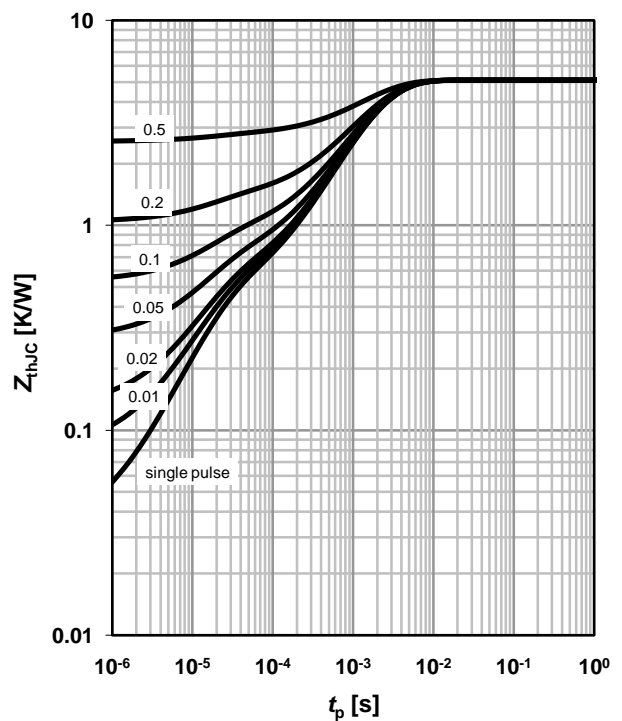

5 Typ. output characteristics

$I_D = f(V_{DS}); T_j = 25\text{ °C}$

parameter: V_{GS}

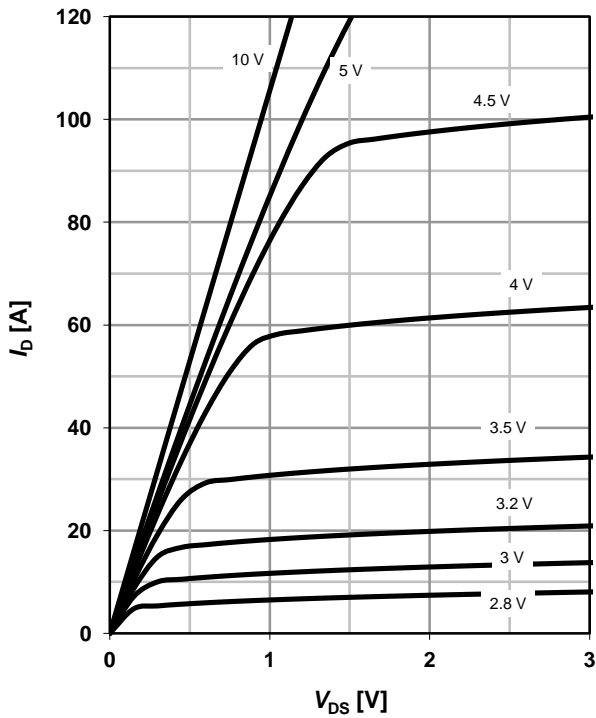

6 Typ. drain-source on resistance

$R_{DS(on)} = f(I_D); T_j = 25\text{ °C}$

parameter: V_{GS}

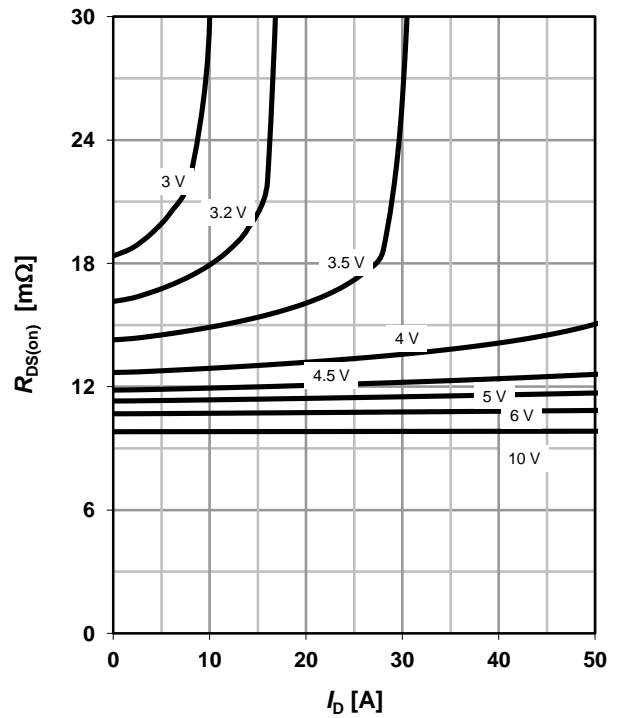

7 Typ. transfer characteristics

$I_D = f(V_{GS}); |V_{DS}| > 2|I_D|R_{DS(on)max}$

parameter: T_j

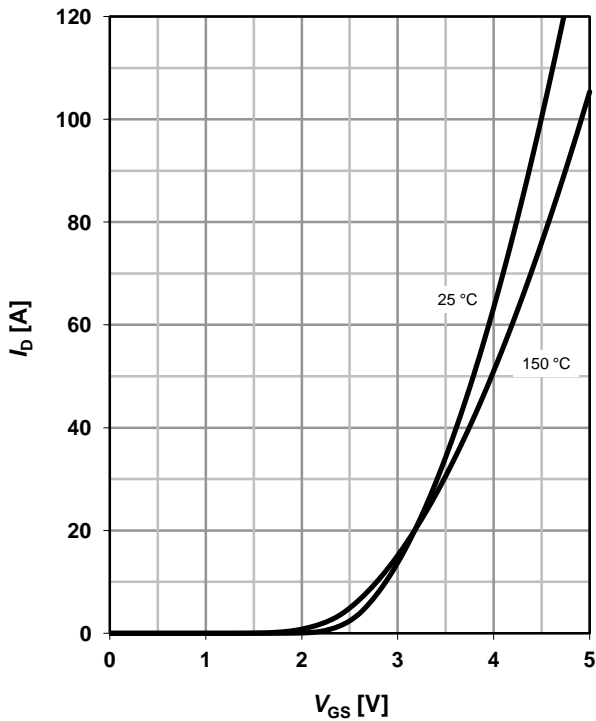

8 Typ. forward transconductance

$g_{fs} = f(I_D); T_j = 25\text{ °C}$

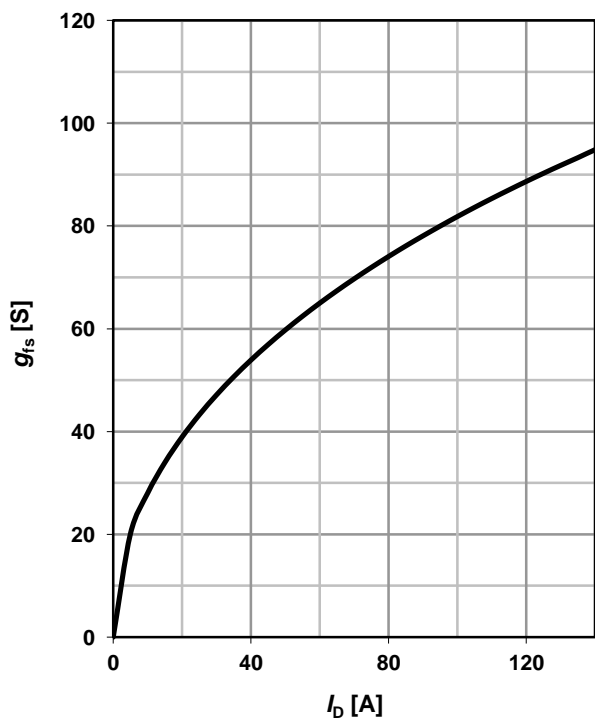

9 Drain-source on-state resistance

$R_{DS(on)}=f(T_j); I_D=20\text{ A}; V_{GS}=10\text{ V}$

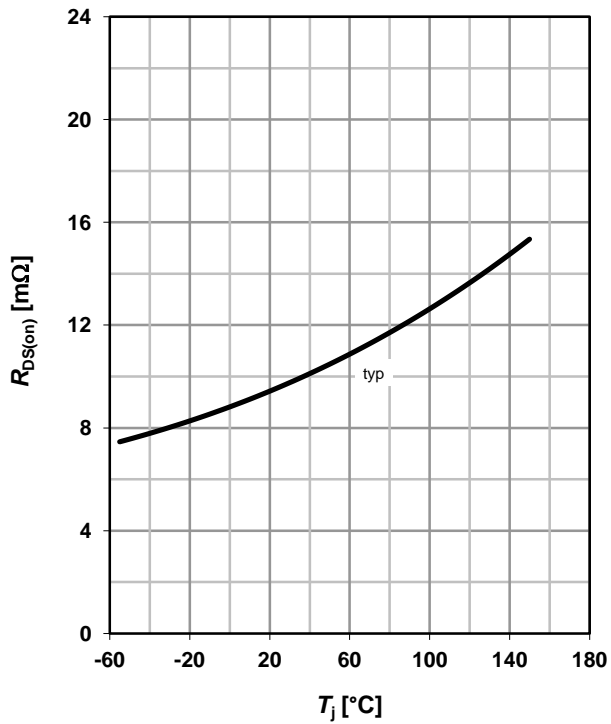

10 Typ. gate threshold voltage

$V_{GS(th)}=f(T_j); V_{GS}=V_{DS}; I_D=250\ \mu\text{A}$

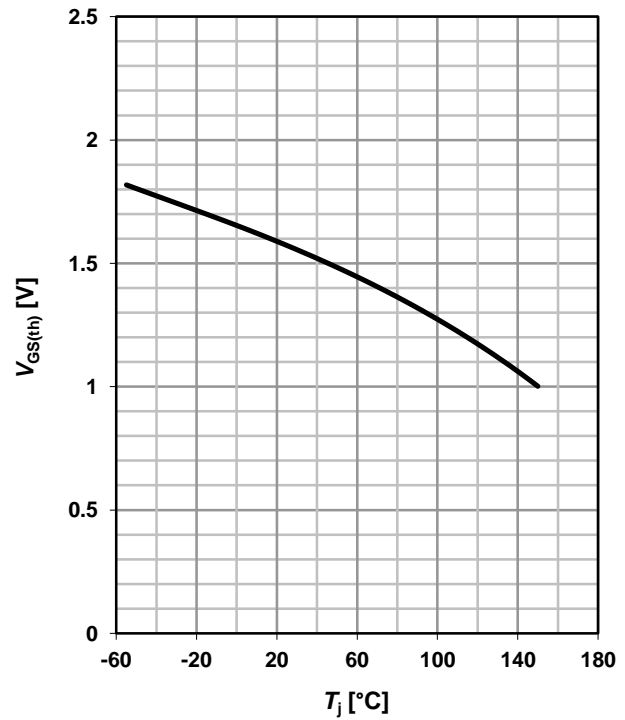

11 Typ. capacitances

$C=f(V_{DS}); V_{GS}=0\text{ V}; f=1\text{ MHz}$

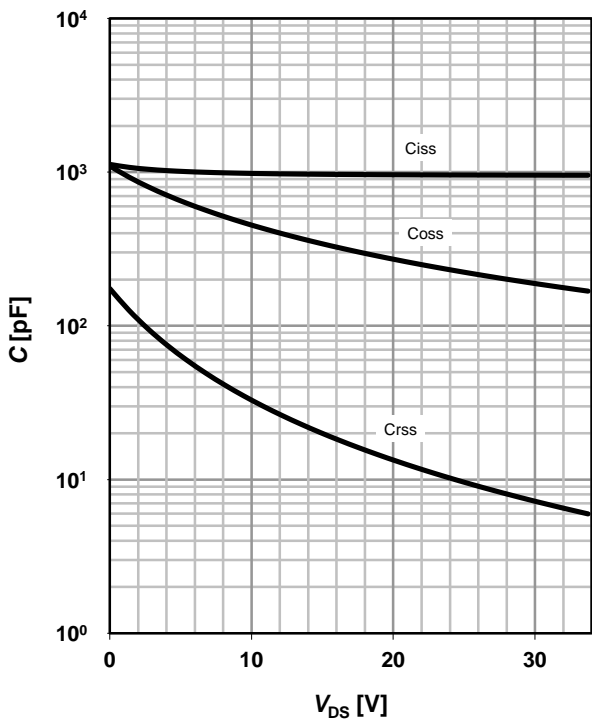

12 Forward characteristics of reverse diode

$I_F=f(V_{SD})$

parameter: T_j

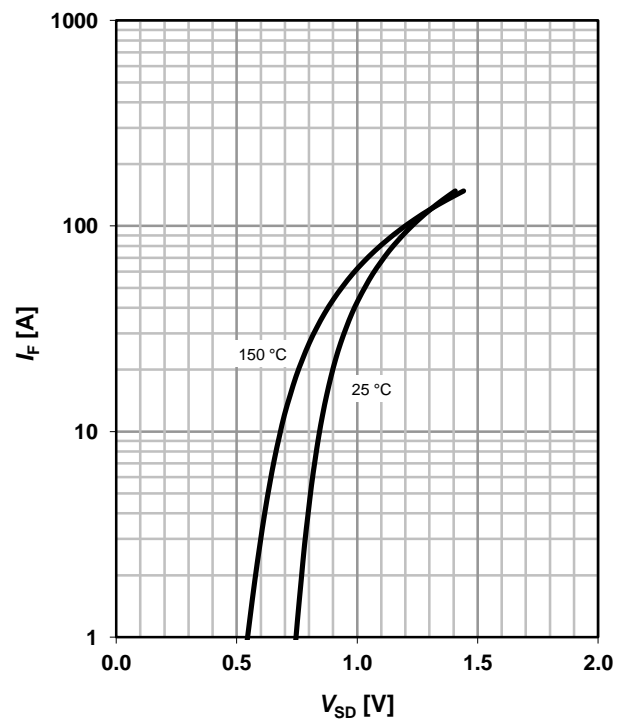

13 Avalanche characteristics

$I_{AS}=f(t_{AV}); R_{GS}=25 \Omega$

parameter: $T_{j(\text{start})}$

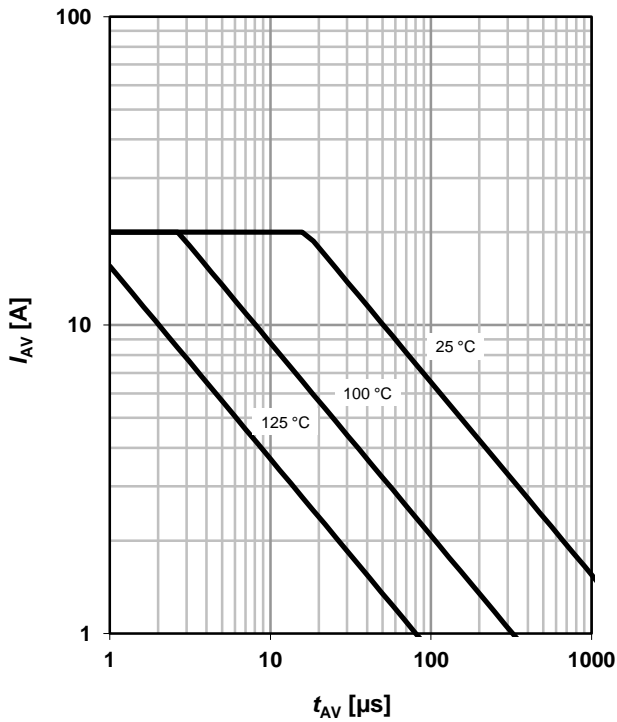

14 Typ. gate charge

$V_{GS}=f(Q_{\text{gate}}); I_D=30 \text{ A pulsed}$

parameter: V_{DD}

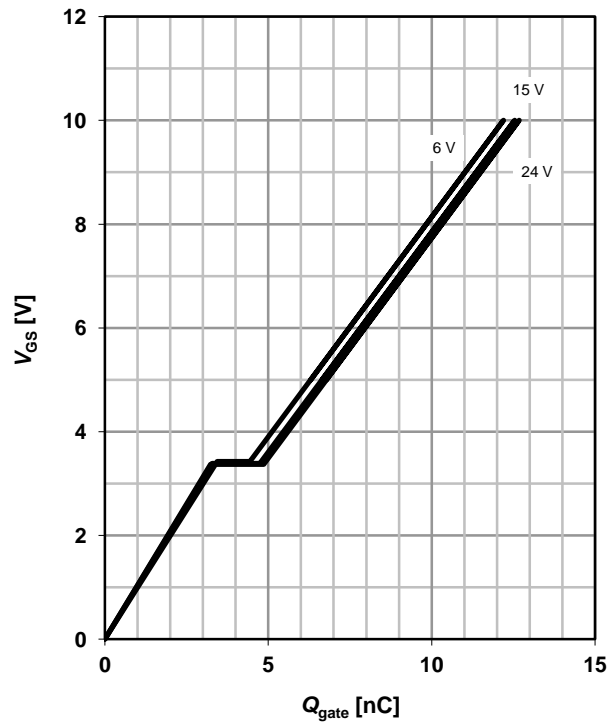

15 Drain-source breakdown voltage

$V_{BR(DSS)}=f(T_j); I_D=1 \text{ mA}$

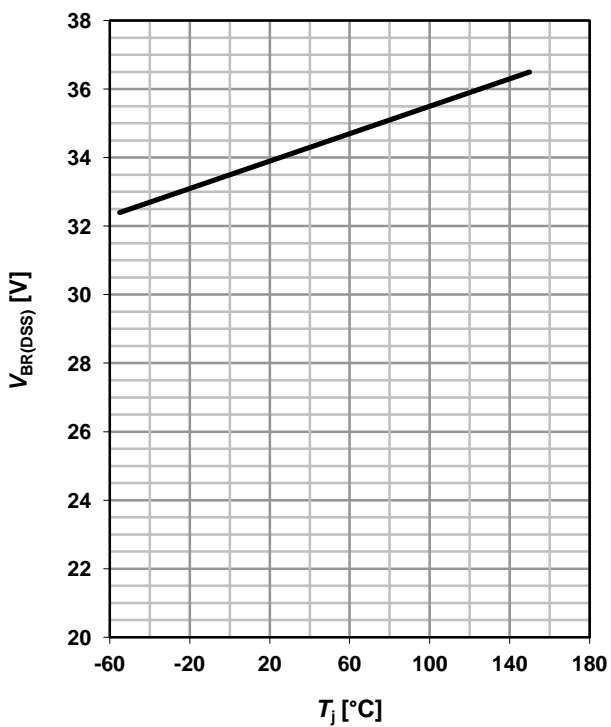

16 Gate charge waveforms

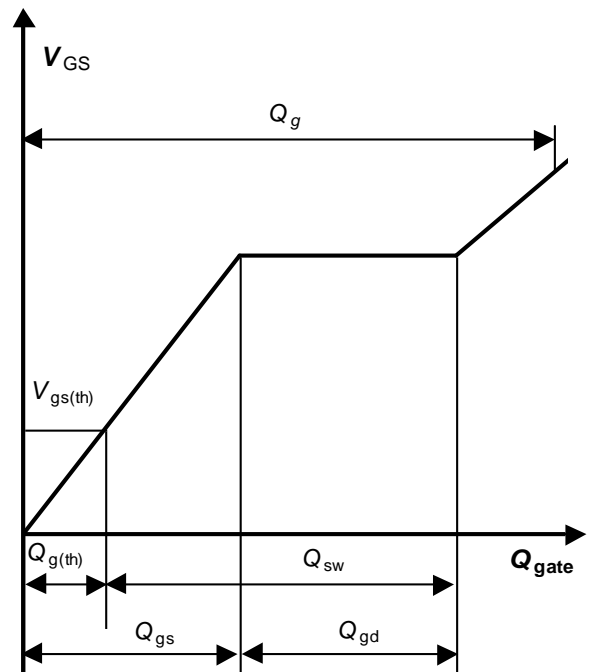

Package Outline

PG-TSDSON-8

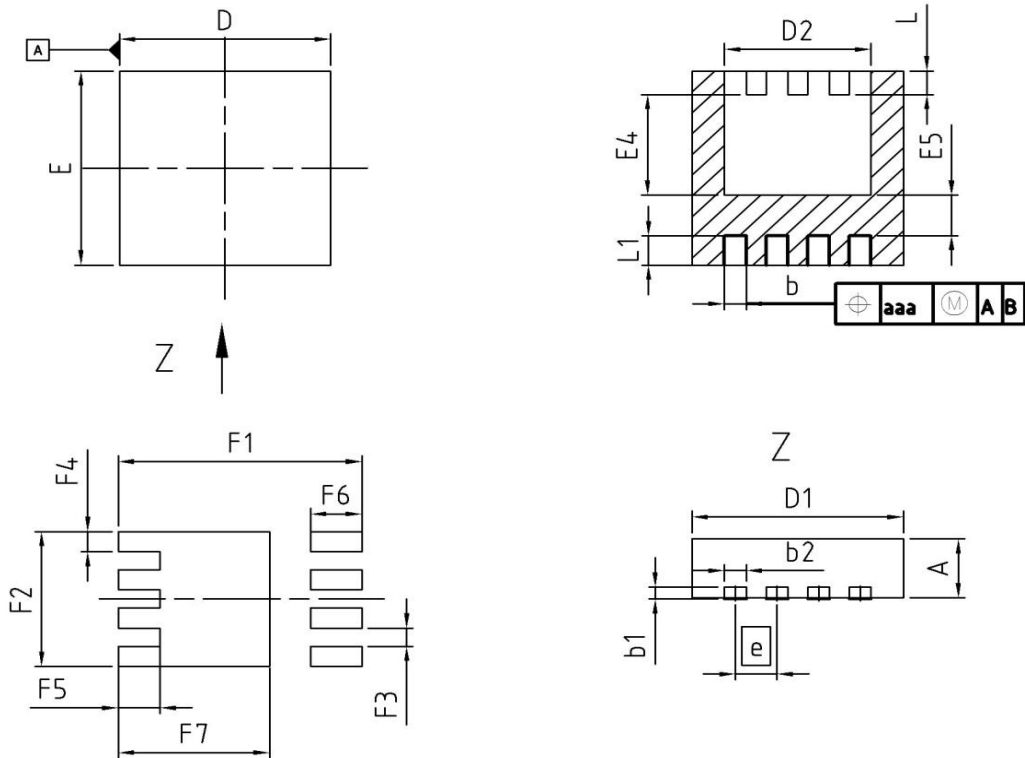

DIM	MILLIMETERS		INCHES	
	MIN	MAX	MIN	MAX
A	0.90	1.10	0.035	0.043
b	0.24	0.44	0.009	0.017
b1	0.10	0.30	0.004	0.012
b2	0.20	0.44	0.008	0.017
D=D1	3.20	3.40	0.126	0.134
D2	2.15	2.45	0.085	0.096
E	3.20	3.40	0.126	0.134
E4	1.60	1.81	0.063	0.071
E5	0.59	0.86	0.023	0.034
e	0.65		0.026	
N	8		8	
L	0.30	0.56	0.012	0.022
L1	0.33	0.60	0.013	0.024
aaa	0.25		0.010	
F1	3.80		0.150	
F2	2.29		0.090	
F3	0.31		0.012	
F4	0.34		0.013	
F5	0.65		0.026	
F6	0.80		0.031	
F7	2.36		0.093	

DOCUMENT NO.
Z8B00131645

SCALE

EUROPEAN PROJECTION

ISSUE DATE
17-09-2008

REVISION
02

Published by
Infineon Technologies AG
81726 Munich, Germany
© 2010 Infineon Technologies AG
All Rights Reserved.

Legal Disclaimer

The information given in this document shall in no event be regarded as a guarantee of conditions or characteristics. With respect to any examples or hints given herein, any typical values stated herein and/or any information regarding the application of the device, Infineon Technologies hereby disclaims any and all warranties and liabilities of any kind, including without limitation, warranties of non-infringement of intellectual property rights of any third party.

Information

For further information on technology, delivery terms and conditions and prices, please contact the nearest Infineon Technologies Office (www.infineon.com).

Warnings

Due to technical requirements, components may contain dangerous substances. For information on the types in question, please contact the nearest Infineon Technologies Office. Infineon Technologies components may be used in life-support devices or systems only with the express written approval of Infineon Technologies, if a failure of such components can reasonably be expected to cause the failure of that life-support device or system or to affect the safety or effectiveness of that device or system. Life support devices or systems are intended to be implanted in the human body or to support and/or maintain and sustain and/or protect human life. If they fail, it is reasonable to assume that the health of the user or other persons may be endangered.



Компания «ЭлектроПласт» предлагает заключение долгосрочных отношений при поставках импортных электронных компонентов на взаимовыгодных условиях!

Наши преимущества:

- Оперативные поставки широкого спектра электронных компонентов отечественного и импортного производства напрямую от производителей и с крупнейших мировых складов;
- Поставка более 17-ти миллионов наименований электронных компонентов;
- Поставка сложных, дефицитных, либо снятых с производства позиций;
- Оперативные сроки поставки под заказ (от 5 рабочих дней);
- Экспресс доставка в любую точку России;
- Техническая поддержка проекта, помощь в подборе аналогов, поставка прототипов;
- Система менеджмента качества сертифицирована по Международному стандарту ISO 9001;
- Лицензия ФСБ на осуществление работ с использованием сведений, составляющих государственную тайну;
- Поставка специализированных компонентов (Xilinx, Altera, Analog Devices, Intersil, Interpoint, Microsemi, Aeroflex, Peregrine, Syfer, Eurofarad, Texas Instrument, Miteq, Cobham, E2V, MA-COM, Hittite, Mini-Circuits, General Dynamics и др.);

Помимо этого, одним из направлений компании «ЭлектроПласт» является направление «Источники питания». Мы предлагаем Вам помощь Конструкторского отдела:

- Подбор оптимального решения, техническое обоснование при выборе компонента;
- Подбор аналогов;
- Консультации по применению компонента;
- Поставка образцов и прототипов;
- Техническая поддержка проекта;
- Защита от снятия компонента с производства.



Как с нами связаться

Телефон: 8 (812) 309 58 32 (многоканальный)

Факс: 8 (812) 320-02-42

Электронная почта: org@eplast1.ru

Адрес: 198099, г. Санкт-Петербург, ул. Калинина, дом 2, корпус 4, литера А.