

Resin board version NBR32 Part number 88973211



- Vibration resistant
- Extended temperature range
- Outputs via removable connectors
- IP50 seal (connectors)
- DB 9-pin programming port via standard RS 232 cable
- Designed for application-specific functions
- Supplied without connectors. Connectors available (Ref. 88970313, 88970314, 88970315, 88970316)

Part numbers

	Type	Designation	Inputs	Outputs	Supply
88973211	NBR32	Relay outputs with connectors	20 digital (including 6 analogue)	12 relays	24 V DC

Specifications

General environment characteristics for CB, CD, XD, XB, XR and XE product types

Certifications	CE, UL, CSA, GL
Conformity to standards (with the low voltage directive and EMC directive)	IEC/EN 61131-2 (Open equipment) IEC/EN 61131-2 (Zone B) IEC/EN 61000-6-2, IEC/EN 61000-6-3 (*) IEC/EN 61000-6-4 (*) Except configuration (88 970 1.1 or 88 970 1.2) + (88 970 250 or 88 970 270) + 88 970 241 class A (class B in a metal enclosure)
Earthing	Not included
Protection rating	In accordance with IEC/EN 60529 : IP40 on front panel IP20 on terminal block
Overvoltage category	3 in accordance with IEC/EN 60664-1
Pollution	Degree : 2 in accordance with IEC/EN 61131-2
Max operating Altitude	Operation : 2000 m Transport : 3048 m
Mechanical resistance	Immunity to vibrations IEC/EN 60068-2-6, test Fc Immunity to shock IEC/EN 60068-2-27, test Ea
Resistance to electrostatic discharge	Immunity to ESD IEC/EN 61000-4-2, level 3
Resistance to HF interference	Immunity to radiated electrostatic fields IEC/EN 61000-4-3 Immunity to fast transients (burst immunity) IEC/EN 61000-4-4, level 3 Immunity to shock waves IEC/EN 61000-4-5 Radio frequency in common mode IEC/EN 61000-4-6, level 3 Voltage dips and breaks (AC) IEC/EN 61000-4-11 Immunity to damped oscillatory waves IEC/EN 61000-4-12
Conducted and radiated emissions	Class B (*) in accordance with EN 55022, EN 55011 (CISPR22, CISPR11) group 1 (*) Except configuration (88 970 1.1 or 88 970 1.2) + (88 970 250 or 88 970 270) + 88 970 241 class A (class B in a metal enclosure)
Operating temperature	-20 → +70 °C except CB and XB versions in VDC : -30 → +70 °C (+40 °C in a non-ventilated enclosure) in accordance with IEC/EN 60068-2-1 and IEC/EN 60068-2-2
Storage temperature	-40 → +80 °C in accordance with IEC/EN 60068-2-1 and IEC/EN 60068-2-2
Relative humidity	95 % max. (no condensation or dripping water) in accordance with IEC/EN 60068-2-30
Mounting	On symmetrical DIN rail, 35 x 7.5 mm and 35 x 15 mm, or on panel (2 x Ø 4 mm)
Screw terminals connection capacity	Flexible wire with ferrule = 1 conductor : 0.25 to 2.5 mm ² (AWG 24...AWG 14) 2 conductors 0.25 to 0.75 mm ² (AWG 24...AWG 18) Semi-rigid wire = 1 conductor : 0.2 to 2.5 mm ² (AWG 25...AWG 14) Rigid wire = 1 conductor : 0.2 to 2.5 mm ² (AWG 25...AWG 14) 2 conductors 0.2 to 1.5 mm ² (AWG 25...AWG 16) Tightening torque = 0.5 N.m (4.5 lb-in) (tighten using screwdriver diam. 3.5 mm) Also valid for spring cage connectors (ref 88 970 313 and 88 970 317 for the RBT range)

General characteristics

Certifications	CE
Protection index	IP50 (removable connectors)
Mechanical resistance IEC 61373	Railway applications - Rolling stock Category 1 class B stock mounted on car Vibration resistance : 5-150 Hz Random sampling : 10 minutes in each direction (X, Y, Z) Sinusoidal sampling : 5 hours in each direction (X, Y, Z) Shock resistance : 3 shocks 3 g/30 ms per direction Dropping : Total of 26 drops on all sides from a height of 1 metre
Mechanical resistance GAM EG 13	Terrestrial military vehicles Vibration resistance 5-500 Hz 50 m/s ² Sinusoidal sampling 5 hours in each direction (X, Y, Z) Shock resistance : Acceleration : 150 m/s ² , duration : 11 ms, 3 shocks per shaft Acceleration : 300 m/s ² , duration : 11 ms, 3 shocks per shaft Bumps : 1000 half wave sine mechanical bumps 15 g / 6 ms per shaft
Operating temperature	-30 → +70 °C (DC)
Storage temperature	-40 → +80 °C
Housing	Self-extinguishing UL94V2
Resin	UL approved Self-extinguishing UL94V0 Semi-rigid polyurethane resin Solid black appearance Breakdown voltage : 25 kV/mn Water absorption : 0.2 % (24 hours at 23 °C) Shore D hardness : 50 ±5 Smoke category : F0
Outputs	Removable connectors
Breaking current	6 A relay output

Processing characteristics of CB, CD, XD & XB product types

LCD display	CD, XD : Display with 4 lines of 18 characters
Programming method	Function blocks / SCF (Grafset) or Ladder
Program size	8 Kb : 350 typical blocks, 64 macros maximum, 256 blocks maximum per macro or 120 lines in Ladder
Program memory	Flash EEPROM
Removable memory	EEPROM
Data memory	368 bit/200 words
Back-up time in the event of power failure	Program and settings in the controller : 10 years Program and settings in the plug-in memory : 10 years Data memory : 10 years
Cycle time	FBD : 6 → 90 ms (typically 20 ms) Ladder : typically 20 ms
Response time	Input acquisition time : 1 to 2 cycle times
Clock data retention	10 years (lithium battery) at 25 °C
Clock drift	Drift < 12 min/year (at 25 °C) 6 s/month (at 25 °C with user-definable correction of drift)
Timer block accuracy	1 % ± 2 cycle times
Start up time on power up	< 1,2 s

Characteristics of products with AC power supplied

Supply		
Nominal voltage	24 V AC	100 → 240 V AC
Operating limits	-15 % / +20 % or 20.4 V AC → 28.8 V AC	-15 % / +10 % or 85 V AC → 264 V AC
Supply frequency range	50/60 Hz (+4 % / -6 %) or 47 → 53 Hz/57 → 63 Hz	50/60 Hz (+4 % / -6 %) or 47 → 53 Hz/57 → 63 Hz
Immunity from micro power cuts	10 ms (repetition 20 times)	10 ms (repetition 20 times)
Max. absorbed power	CB12-CD12-XD10-XB10 : 4 VA CB20-CD20 : 6 VA XD10-XB10 with extension : 7.5 VA XD26-XB26 : 7.5 VA XD26-XB26 with extension : 10 VA	CB12-CD12-XD10-XB10 : 7 VA CB20-CD20 : 11 VA XD10-XB10 with extension : 12 VA XD26-XB26 : 12 VA XD26-XB26 with extension : 17 VA
Isolation voltage	1780 V AC	1780 V AC

Inputs

Input voltage	24 V AC (-15 % / +20 %)	100 → 240 V AC (-15 % / +10 %)
Input current	4.4 mA @ 20.4 V AC 5.2 mA @ 24.0 V AC 6.3 mA @ 28.8 V AC	0.24 mA @ 85 V AC 0.75 mA @ 264 V AC
Input impedance	4.6 kΩ	350 kΩ
Logic 1 voltage threshold	≥ 14 V AC	≥ 79 V AC
Making current at logic state 1	> 2 mA	> 0.17 mA
Logic 0 voltage threshold	≤ 5 V AC	≤ 20 V AC (≤ 28 V AC : XE10, XR06, XR10, XR14)
Release current at logic state 0	< 0.5 mA	< 0.5 mA
Response time with LADDER programming	50 ms State 0 → 1 (50/60 Hz)	50 ms State 0 → 1 (50/60 Hz)
Response time with function blocks programming	Configurable in increments of 10 ms 50 ms min. up to 255 ms State 0 → 1 (50/60 Hz)	Configurable in increments of 10 ms 50 ms min. up to 255 ms State 0 → 1 (50/60 Hz)
Maximum counting frequency	In accordance with cycle time (Tc) and input response time (Tr) : 1/ ((2 x Tc) + Tr)	In accordance with cycle time (Tc) and input response time (Tr) : 1/ ((2 x Tc) + Tr)

Sensor type	Contact or 3-wire PNP	Contact or 3-wire PNP
Input type	Resistive	Resistive
Isolation between power supply and inputs	None	None
Isolation between inputs	None	None
Protection against polarity inversions	Yes	Yes
Status indicator	On LCD screen for CD and XD	On LCD screen for CD and XD

Characteristics of relay outputs common to the entire range

Max. breaking voltage	5 →30 V DC 24 →250 V AC
Breaking current	CB-CD-XD10-XB10-XR06-XR10 : 8 A XD26-XB26 : 8 x 8 A relays, 2 x 5 A relays XE10 : 4 x 5 A relays XR14 : 4 x 8 A relays, 2 x 5 A relays RBT (Removable Terminal Blocks) versions : verify the maximum current according to the type of connection used
Electrical durability for 500 000 operating cycles	Utilization category DC-12 : 24 V, 1.5 A Utilization category DC-13 : 24 V (L/R = 10 ms), 0.6 A Utilization category AC-12 : 230 V, 1.5 A Utilization category AC-15 : 230 V, 0.9 A
Max. Output Common Current	12 A for O8, O9, OA
Minimum switching capacity	10 mA (at minimum voltage of 12 V)
Minimum load	12 V, 10 mA
Maximum rate	Off load : 10 Hz At operating current : 0.1 Hz
Mechanical life	10,000,000 (operations)
Voltage for withstanding shocks	In accordance with IEC/EN 60947-1 and IEC/EN 60664-1 : 4 kV
Off-cycle response time	Make 10 ms Release 5 ms
Built-in protections	Against short-circuits : None Against overvoltages and overloads : None
Status indicator	On LCD screen for CD and XD

Characteristics of product with DC power supplied

Supply		
Nominal voltage	12 V DC	24 V DC
Operating limits	-13 % / +20 % or 10.4 V DC→14.4 V DC (including ripple)	-20 % / +25 % or 19.2 V DC→30 V DC (including ripple)
Immunity from micro power cuts	≤ 1 ms (repetition 20 times)	≤ 1 ms (repetition 20 times)
Max. absorbed power	CB12 with solid state outputs : 1.5 W CD12 : 1.5 W CD20 : 2.5 W XD26-XB26 : 3 W XD26-XB26 with extension : 5 W XD26 with solid state outputs : 2.5 W	CB12-CD12-CD20 with solid state outputs - XD10-XB10 with solid state outputs : 3 W XD10-XB10 with relay outputs : 4 W XD26-XB26 with solid state outputs : 5 W CB20-CD20 with relay outputs : 6 W XD26 with relay outputs : 6 W XD10-XB10 with extension : 8 W XD26-XB26 with extension : 10 W
Protection against polarity inversions	Yes	Yes

Digital inputs (I1 to IA and IH to IY)

Input voltage	12 V DC (-13 % / +20 %)	24 V DC (-20 % / +25 %)
Input current	3.9 mA @ 10.44 V DC 4.4 mA @ 12.0 V DC 5.3 mA @ 14.4 VDC	2.6 mA @ 19.2 V DC 3.2 mA @ 24 V DC 4.0 mA @ 30.0 VDC
Input impedance	2.7 kΩ	7.4 kΩ
Logic 1 voltage threshold	≥ 7 V DC	≥ 15 V DC
Making current at logic state 1	≥ 2 mA	≥ 2.2 mA
Logic 0 voltage threshold	≤ 3 V DC	≤ 5 V DC
Release current at logic state 0	< 0.9 mA	< 0.75 mA
Response time	1 →2 cycle times + 6 ms	1 →2 cycle times + 6 ms
Maximum counting frequency	Inputs I1 & I2 : FBD (up to 6 k Hz) & Ladder (1 k Hz) Inputs I3 to IA & IH to IY : In accordance with cycle time (Tc) and input response time (Tr) : 1/ ((2 x Tc) + Tr)	Inputs I1 & I2 : FBD (up to 6 k Hz) & Ladder (1 k Hz) Inputs I3 to IA & IH to IY : In accordance with cycle time (Tc) and input response time (Tr) : 1/ ((2 x Tc) + Tr)
Sensor type	Contact or 3-wire PNP	Contact or 3-wire PNP
Conforming to IEC/EN 61131-2	Type 1	Type 1
Input type	Resistive	Resistive
Isolation between power supply and inputs	None	None
Isolation between inputs	None	None
Protection against polarity inversions	Yes	Yes
Status indicator	On LCD screen for CD and XD	On LCD screen for CD and XD

Analogue or digital inputs (IB to IG)

CB12-CD12-XD10-XB10	4 inputs IB →IE	4 inputs IB →IE
CB20-CD20-XB26-XD26	6 inputs IB →IG	6 inputs IB →IG

Inputs used as analogue input only in FBD

Measurement range	(0 →10 V) or (0 →V power supply)	(0 →10 V) or (0 →V power supply)
Input impedance	14 kΩ	12 kΩ
Input voltage	14.4 V DC max.	30 V DC max.
Value of LSB	14 mV	29 mV
Input type	Common mode	Common mode
Resolution	10 bit at max. input voltage	10 bit at max. input voltage
Conversion time	Controller cycle time	Controller cycle time
Accuracy at 25 °C	± 5 %	± 5 %
Accuracy at 55 °C	± 6.2 %	± 6.2 %
Repeat accuracy at 55 °C	± 2 %	± 2 %

Isolation between analogue channel and power supply	None	None
Cable length	10 m maximum, with shielded cable (sensor not isolated)	10 m maximum, with shielded cable (sensor not isolated)
Protection against polarity inversions	Yes	Yes
Potentiometer control	2.2 k Ω /0.5 W (recommended) 10 k Ω max.	2.2 k Ω /0.5 W (recommended) 10 k Ω max.

Inputs used as digital inputs

Input voltage	12 V DC (-13 % / +20 %)	24 V DC (-20 % / +25 %)
Input current	0.7 mA @ 10.44 VDC 0.9 mA @ 12.0 VDC 1.0 mA @ 14.4VDC	1.6 mA @ 19.2 VDC 2.0 mA @ 24.0 V DC 2.5 mA @ 30.0 VDC
Input impedance	14 k Ω	12 k Ω
Logic 1 voltage threshold	≥ 7 V DC	≥ 15 VDC
Making current at logic state 1	≥ 0.5 mA	≥ 1.2 mA
Logic 0 voltage threshold	≤ 3 V DC	≤ 5 V DC
Release current at logic state 0	≤ 0.2 mA	≤ 0.5 mA
Response time	1 \rightarrow 2 cycle times	1 \rightarrow 2 cycle times
Maximum counting frequency in FBD	In accordance with cycle time (Tc) and input response time (Tr) : $1 / ((2 \times Tc) + Tr)$	In accordance with cycle time (Tc) and input response time (Tr) : $1 / ((2 \times Tc) + Tr)$
Sensor type	Contact or 3-wire PNP	Contact or 3-wire PNP
Conforming to IEC/EN 61131-2	Type 1	Type 1
Input type	Resistive	Resistive
Isolation between power supply and inputs	None	None
Isolation between inputs	None	None
Protection against polarity inversions	Yes	Yes
Status indicator	On LCD screen for CD and XD	On LCD screen for CD and XD

Characteristics of relay outputs common to the entire range

Max. breaking voltage	5 \rightarrow 30 V DC 24 \rightarrow 250 V AC
Max. Output Common Current	12A (10A UL) for O8, O9, OA
Breaking current	CB-CD-XD10-XB10-XR06-XR10 : 8 A XD26-XB26 : 8 x 8 A relays, 2 x 5 A relays XE10 : 4 x 5 A relays XR14 : 4 x 8 A relays, 2 x 5 A relays
Electrical durability for 500 000 operating cycles	Utilization category DC-12 : 24 V, 1.5 A Utilization category DC-13 : 24 V (L/R = 10 ms), 0.6 A Utilization category AC-12 : 230 V, 1.5 A Utilization category AC-15 : 230 V, 0.9 A
Minimum switching capacity	10 mA (at minimum voltage of 12 V)
Minimum load	12 V, 10 mA
Maximum rate	Off load : 10 Hz At operating current : 0.1 Hz
Mechanical life	10,000,000 (operations)
Voltage for withstanding shocks	In accordance with IEC/EN 60947-1 and IEC/EN 60664-1 : 4 kV
Off-cycle response time	Make 10 ms Release 5 ms
Built-in protections	Against short-circuits : None Against overvoltages and overloads : None
Status indicator	On LCD screen for CD and XD

Digital / PWM solid state output

PWM solid state output*	CB12 : O4 XD26 : O4 \rightarrow O7	CD12-XD10-XB10 : O4 CD20-XD26-XB26 : O4 \rightarrow O7
* Only available with "FBD" programming language	* Only available with "FBD" programming language	
Breaking voltage	10.4 \rightarrow 30 V DC	19.2 \rightarrow 30 V DC
Nominal voltage	12-24 VDC	24 V DC
Nominal current	0.5 A	0.5 A
Max. breaking current	0,625 A	0,625 A
Voltage drop	≤ 2 V for I = 0.5 A (at state 1)	≤ 2 V for I = 0.5 A (at state 1)
Response time	Make ≤ 1 ms Release ≤ 1 ms	Make ≤ 1 ms Release ≤ 1 ms
Operating frequency	1 Maximum on inductive load	1 Maximum on inductive load
Built-in protections	Against overloads and short-circuits : Yes Against overvoltages (*) : Yes Against inversions of power supply : Yes (*) In the absence of a volt-free contact between the logic controller output and the load	Against overloads and short-circuits : Yes Against overvoltages (*) : Yes Against inversions of power supply : Yes (*) In the absence of a volt-free contact between the logic controller output and the load
Min. load	1 mA	1 mA
Maximum incandescent load	0,2 A / 12 V DC 0,1 A / 24 V DC	0,1 A / 24 V DC
Galvanic isolation	No	No
PWM frequency	14.11 Hz 56.45 Hz 112.90 Hz 225.80 Hz 451.59 Hz 1806.37 Hz	14.11 Hz 56.45 Hz 112.90 Hz 225.80 Hz 451.59 Hz 1806.37 Hz
PWM cyclic ratio	0 \rightarrow 100 % (256 steps for CD, XD and 1024 steps for XA)	0 \rightarrow 100 % (256 steps for CD, XD and 1024 steps for XA)
Max. Breaking current PWM	50 mA	50 mA
Max. cable length PWM	20 m	20 m
PWM accuracy at 120 Hz	< 5 % (20 % \rightarrow 80 %) load at 10 mA	< 5 % (20 % \rightarrow 80 %) load at 10 mA
PWM accuracy at 500 Hz	< 10 % (20 % \rightarrow 80 %) load at 10 mA	< 10 % (20 % \rightarrow 80 %) load at 10 mA
Status indicator	On LCD screen for XD	On LCD screen for CD and XD

Accessories

Type	Description	Code
M3 Soft	Multilingual programming software containing specific library functions (CD-ROM)	88970111
PA	1.80 m serial link cable : DB9 M / DB9 F	88970123
PA	PC : USB →DB9 (RS 232) link cable	88950105
MA	Removable connector kit for NBR32	88970315

Dimensions (mm)

NBR32

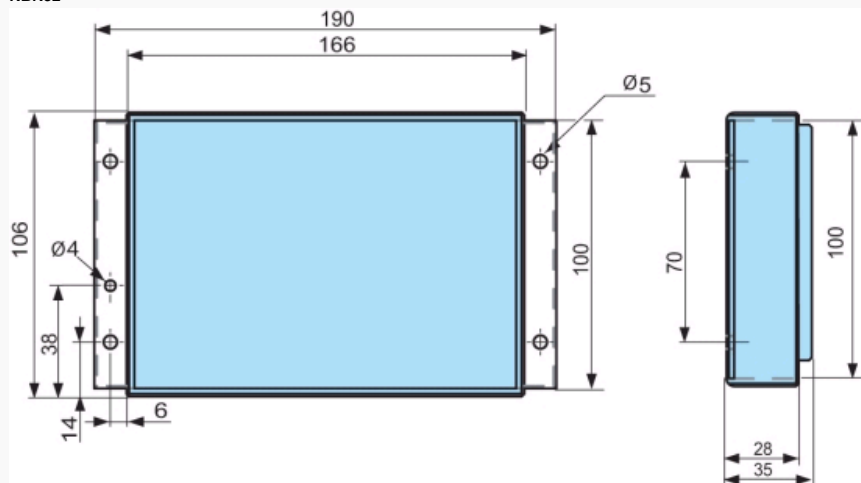

mm

Product adaptations

- 40 cm wire
- Extended power supply range (9 →18 VDC), (16 →36 VDC)
- Remote polyester keyboard
- UL, CSA, GL certification
- Integration of all available electrical functions in the catalogue (e.g. : Bluetooth® module, Pt100 input, 0-20 mA input, 0-10 V power output, etc)
- Changing the number of I/O



Компания «ЭлектроПласт» предлагает заключение долгосрочных отношений при поставках импортных электронных компонентов на взаимовыгодных условиях!

Наши преимущества:

- Оперативные поставки широкого спектра электронных компонентов отечественного и импортного производства напрямую от производителей и с крупнейших мировых складов;
- Поставка более 17-ти миллионов наименований электронных компонентов;
- Поставка сложных, дефицитных, либо снятых с производства позиций;
- Оперативные сроки поставки под заказ (от 5 рабочих дней);
- Экспресс доставка в любую точку России;
- Техническая поддержка проекта, помощь в подборе аналогов, поставка прототипов;
- Система менеджмента качества сертифицирована по Международному стандарту ISO 9001;
- Лицензия ФСБ на осуществление работ с использованием сведений, составляющих государственную тайну;
- Поставка специализированных компонентов (Xilinx, Altera, Analog Devices, Intersil, Interpoint, Microsemi, Aeroflex, Peregrine, Syfer, Eurofarad, Texas Instrument, Miteq, Cobham, E2V, MA-COM, Hittite, Mini-Circuits, General Dynamics и др.);

Помимо этого, одним из направлений компании «ЭлектроПласт» является направление «Источники питания». Мы предлагаем Вам помощь Конструкторского отдела:

- Подбор оптимального решения, техническое обоснование при выборе компонента;
- Подбор аналогов;
- Консультации по применению компонента;
- Поставка образцов и прототипов;
- Техническая поддержка проекта;
- Защита от снятия компонента с производства.



Как с нами связаться

Телефон: 8 (812) 309 58 32 (многоканальный)

Факс: 8 (812) 320-02-42

Электронная почта: org@eplast1.ru

Адрес: 198099, г. Санкт-Петербург, ул. Калинина, дом 2, корпус 4, литера А.