



00-9175-00X-701-XX6

PREFIX

SERIES

NO. OF WAYS

CODE	NO. OF WAYS
002	2
003	3

Elco Europe (A Division of AVX Ltd) CONFIDENTIAL PROPRIETARY
The document on this print and information therewith are PROPRIETY
to Elco Europe (A Division of AVX Ltd) and shall not be copied
or disclosed in whole or in part without Elco Europe's written consent.

WIRE GAUGE SIZE

CODE	DESCRIPTION	ACCEPTED WIRE GAUGE	WIRE INSULATION
701	CAP PRE-ASSEMBLED	28 GAUGE SOLID OR STRANDED 26 GAUGE SOLID OR STRANDED	MIN Ø0.70 MAX Ø1.00

INSULATION COLOUR

CODE	INSULATION COLOUR	AVAILABILITY
0	BLACK	SPECIAL ORDER
1	WHITE	STANDARD

CAP OPTIONS

CODE	CAP OPTION	DESCRIPTION	SHEET
0	THROUGH WIRE	ALLOWS WIRE TO BE TERMINATED AT ANY POINT	2&3
9	WIRE STOP	TERMINATES END OF WIRE END PROTECTED BY STOP FACE	4&5

PLATING OPTION

CODE	DESCRIPTION
6	PURE TIN OVER ALL OVER



ELCO EUROPE (A DIVISION OF AVX LTD.) CONFIDENTIAL PROPRIETARY
THE DRAWING ON THIS PRINT AND INFORMATION THEREWITH ARE
PROPRIETARY TO ELCO EUROPE (A DIVISION OF AVX LTD.) AND
SHALL NOT BE USED OR DISCLOSED IN WHOLE OR IN PART
WITHOUT ELCO EUROPE'S WRITTEN CONSENT.

SHEET 1 OF 6

FORM-106-01-036-6 ISS 7
Release No.
History
102869
04.05.2012
22.05.2012

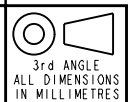

ELCO
© COPYRIGHT ELCO EUROPE
NOT TO BE DISCLOSED OR COPIED
WITHOUT WRITTEN PERMISSION

Drawn N.C.H.	Description 26-28AWG IDC WIRE TO BOARD CONNECTOR	DATE 04-Apr-12
Size CV	Part Number 00-9175-01_700S	Issue B

**26-28 AWG 2 WAY IDC CONNECTOR
THROUGH WIRE CAPPED IDC**

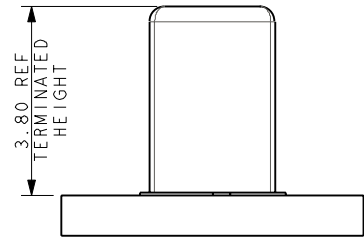
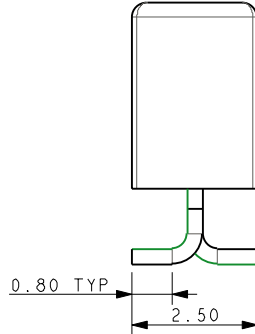
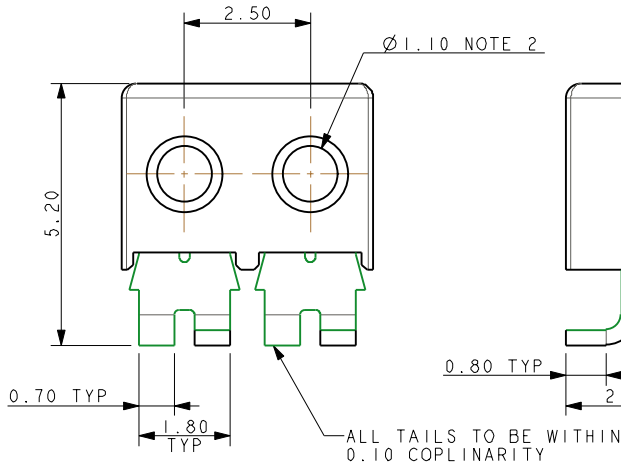
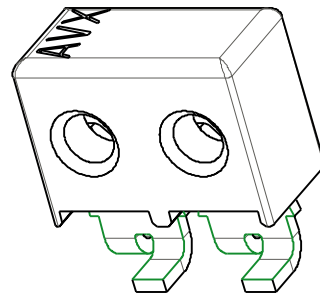
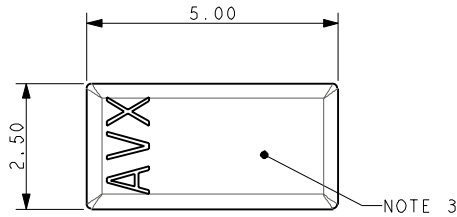

MOUNTED ON PCB

Elco Europe (A Division of AVX Ltd) CONFIDENTIAL PROPRIETY
The document on this print and information therewith are PROPRIETY to Elco Europe (A Division of AVX Ltd) and shall not be copied or disclosed in whole or in part without Elco Europe's written consent.

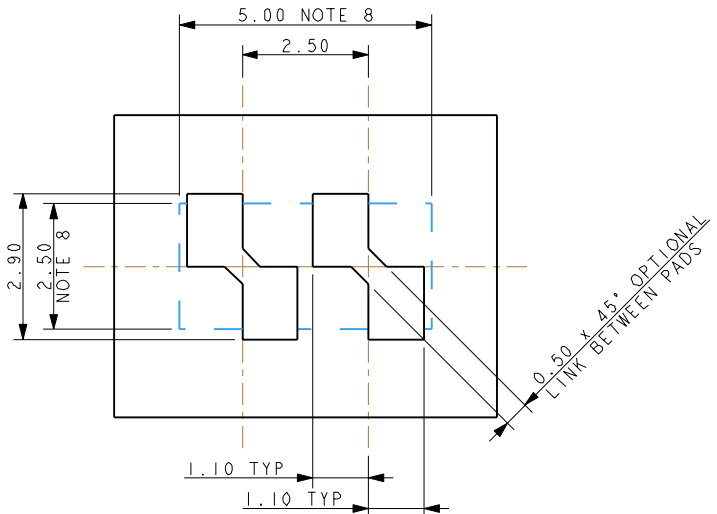
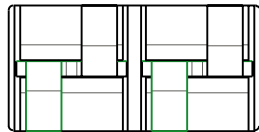

SUGGESTED PCB LAYOUT

PACKING DETAILS

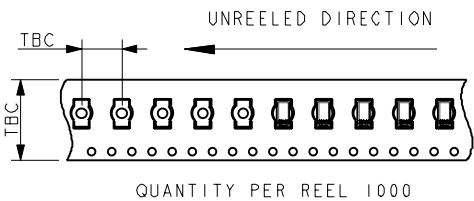
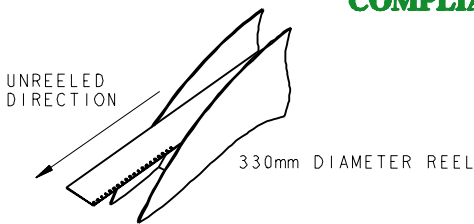

NOTES :-

- 2 WAY CONNECTOR FOR IDC WIRE TO BOARD CONNECTION, PRE-ASSEMBLED THROUGH WIRE CAP.
- CONTACT/CAP TO MATCH 26AWG AND 28AWG WIRES, SOLID OR STANDED CONDUCTOR, MAXIMUM INSULATOR 1.00mm DIAMETER.
- FLAT FACE ON TOP OF CAP TO AID PICK AND PLACE ASSEMBLY.
- FOR FULL DETAILS REFER TO ELCO SPECIFICATION 201-01-139.
- ASSEMBLY PROCEDURE, REFER TO APPLICATION NOTES 201-01-140.
- GENERAL TOLERANCE ± 0.20 UNLESS STATED.
- PACKED IN TAPE AND REEL, QUANTITY PER REEL 1000.
- CONNECTOR OUTLINE.
- CONTACT MATERIAL :- TIN PLATED COPPER ALLOY.
- INSULATOR MATERIAL :- HIGH TEMPERATURE NYLON, GLASS FILLED, UL94 V-0, COLOUR REFER TO SHEET 1.

ELCO EUROPE (A DIVISION OF AVX LTD.) CONFIDENTIAL PROPRIETY
THE DRAWING ON THIS PRINT AND INFORMATION THEREWITH ARE PROPRIETARY TO ELCO EUROPE (A DIVISION OF AVX LTD.) AND SHALL NOT BE USED OR DISCLOSED IN WHOLE OR IN PART WITHOUT ELCO EUROPE'S WRITTEN CONSENT.

SHEET 2 OF 6

Release No.
History
102869
04.05.2012
22.05.2012

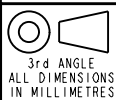

ELCO
© COPYRIGHT ELCO EUROPE
NOT TO BE DISCLOSED OR COPIED
WITHOUT WRITTEN PERMISSION

Drawn
N.C.H.
Size
CV

Description
26-28AWG IDC WIRE TO BOARD CONNECTOR
Part Number
00-9175-01_700S

DATE
03-Apr-12
Issue
B

A

B

**26-28 AWG 3 WAY IDC CONNECTOR
THROUGH WIRE CAPPED IDC**

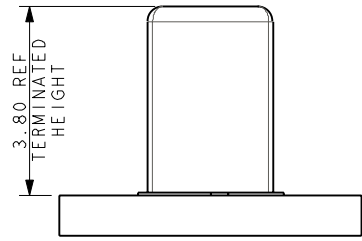
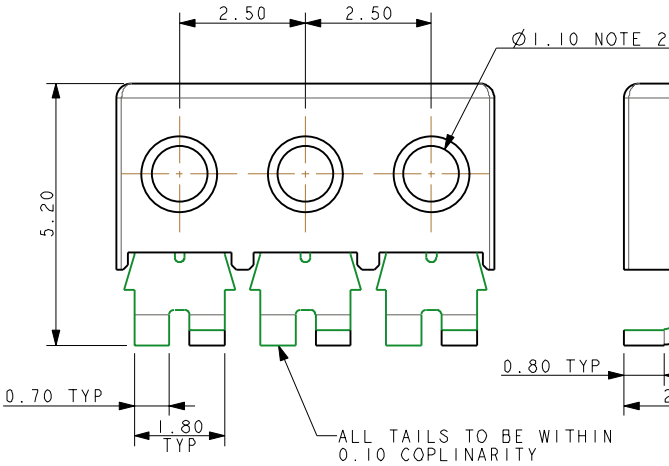
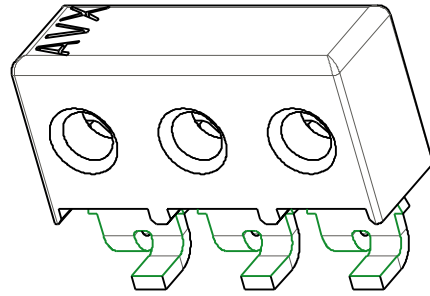
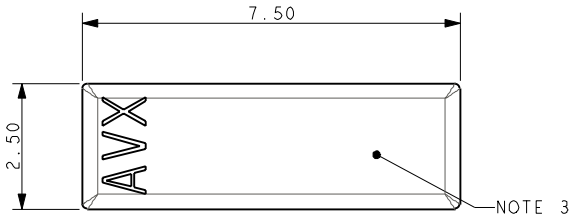

MOUNTED ON PCB

Elco Europe (A Division of AVX Ltd) CONFIDENTIAL PROPRIETY
The document on this print and information therewith are PROPRIETY
to Elco Europe (A Division of AVX Ltd) and shall not be copied
or disclosed in whole or in part without Elco Europe's written consent.

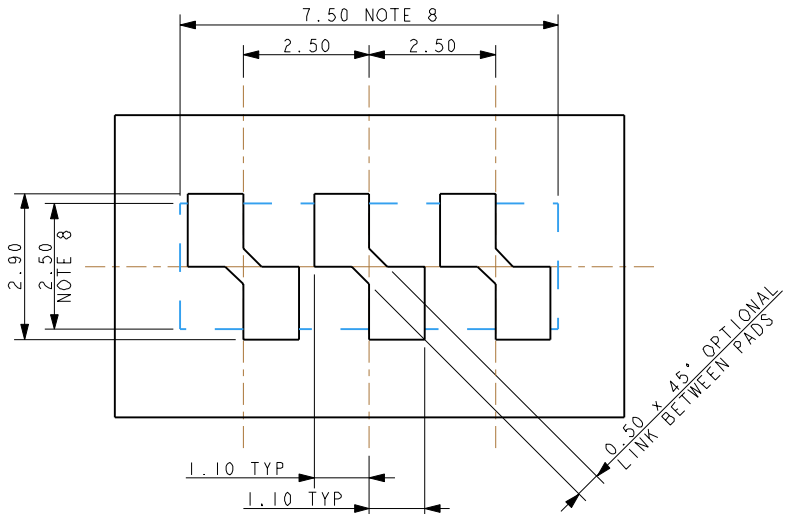
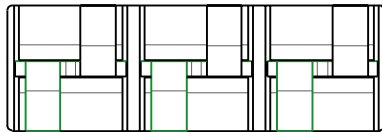

SUGGESTED PCB LAYOUT

PACKING DETAILS

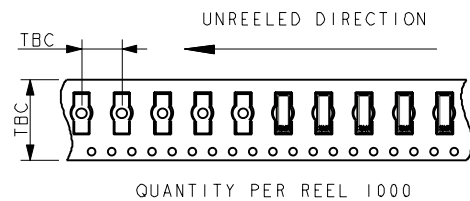
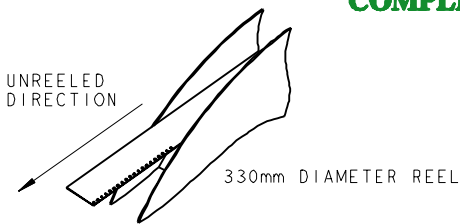

NOTES :-

1. 3 WAY CONNECTOR FOR IDC WIRE TO BOARD CONNECTION, PRE-ASSEMBLED THROUGH WIRE CAP.
2. CONTACT/CAP TO MATCH 26AWG AND 28AWG WIRES, SOLID OR STANDED CONDUCTOR, MAXIMUM INSULATOR 1.00mm DIAMETER.
3. FLAT FACE ON TOP OF CAP TO AID PICK AND PLACE ASSEMBLY.
4. FOR FULL DETAILS REFER TO ELCO SPECIFICATION 201-01-139.
5. ASSEMBLY PROCEDURE, REFER TO APPLICATION NOTES 201-01-140.
6. GENERAL TOLERANCE ± 0.20 UNLESS STATED.
7. PACKED IN TAPE AND REEL, QUANTITY PER REEL 1000.
8. CONNECTOR OUTLINE.
9. CONTACT MATERIAL :- TIN PLATED COPPER ALLOY.
10. INSULATOR MATERIAL :- HIGH TEMPERATURE NYLON, GLASS FILLED, UL94 V-0, COLOUR REFER TO SHEET 1.

ELCO EUROPE (A DIVISION OF AVX LTD.) CONFIDENTIAL PROPRIETY
THE DRAWING ON THIS PRINT AND INFORMATION THEREWITH ARE
PROPRIETARY TO ELCO EUROPE (A DIVISION OF AVX LTD.) AND
SHALL NOT BE USED OR DISCLOSED IN WHOLE OR IN PART
WITHOUT ELCO EUROPE'S WRITTEN CONSENT.

SHEET 3 OF 6

Release No. History 102869 04.05.2012 22.05.2012
--

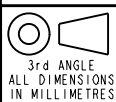

Drawn N.C.H.	Description 26-28AWG IDC WIRE TO BOARD CONNECTOR	DATE 03-Apr-12
Size CV	Part Number 00-9175-01_700S	Issue B

A

B

**26-28 AWG 2 WAY IDC CONNECTOR
WIRE STOP CAPPED IDC**

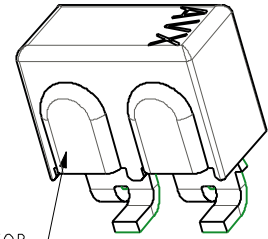
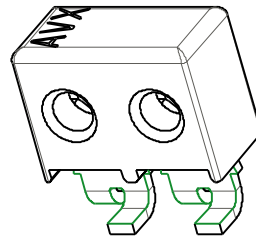
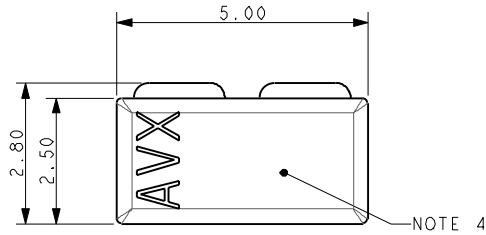

WIRE STOP
NOTE 2

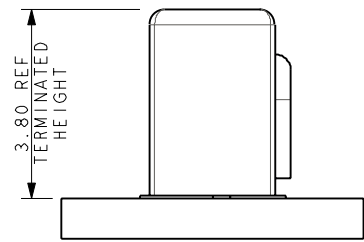
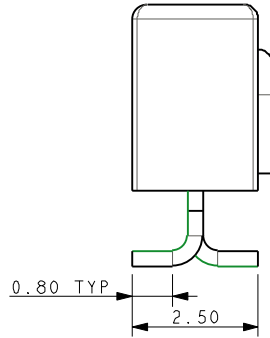
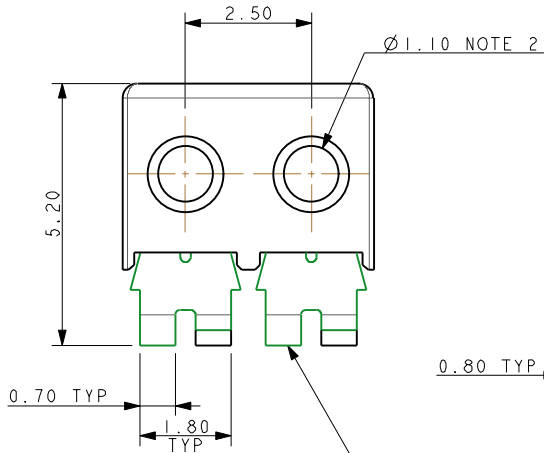

MOUNTED ON PCB

Elco Europe (A Division of AVX Ltd) CONFIDENTIAL PROPRIETY
The document on this print and information therewith are PROPRIETY
to Elco Europe (A Division of AVX Ltd) and shall not be copied
or disclosed in whole or in part without Elco Europe's written consent.

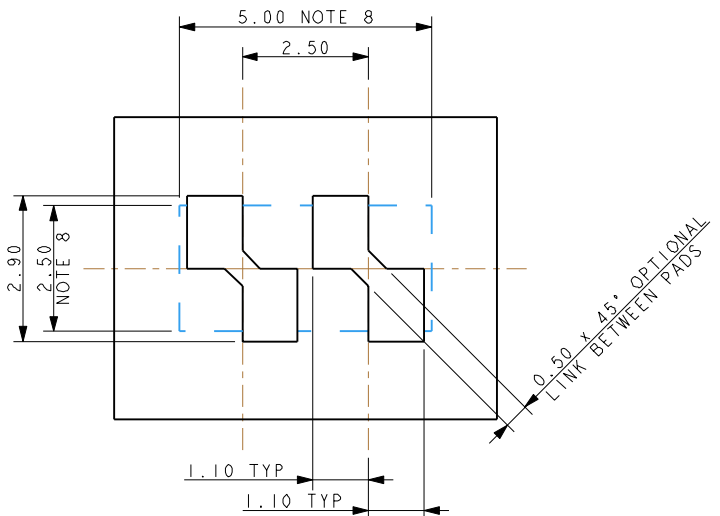
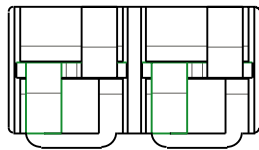

SUGGESTED PCB LAYOUT

PACKING DETAILS



**RoHS
COMPLIANT**

UNREELED
DIRECTION

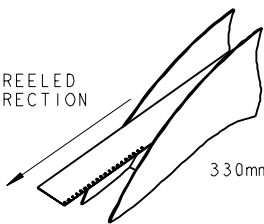

330mm DIAMETER REEL

UNREELED DIRECTION

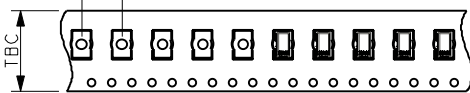

QUANTITY PER REEL 1000

NOTES :-

1. 2 WAY CONNECTOR FOR IDC WIRE TO BOARD CONNECTION, PRE-ASSEMBLED WIRE STOP CAP.
2. WIRE STOP CAP PROTECTS END OF WIRE.
3. CONTACT/CAP TO MATCH 26AWG AND 28AWG WIRES, SOLID OR STANDED CONDUCTOR, MAXIMUM INSULATOR 1.00mm DIAMETER.
4. FLAT FACE ON TOP OF CAP TO AID PICK AND PLACE ASSEMBLY.
5. FOR FULL DETAILS REFER TO ELCO SPECIFICATION 201-01-139.
6. ASSEMBLY PROCEDURE, REFER TO APPLICATION NOTES 201-01-140.
7. GENERAL TOLERANCE ±0.20 UNLESS STATED.
8. PACKED IN TAPE AND REEL, QUANTITY PER REEL 1000.
9. CONNECTOR OUTLINE.
10. CONTACT MATERIAL :- TIN PLATED COPPER ALLOY.
11. INSULATOR MATERIAL :- HIGH TEMPERATURE NYLON, GLASS FILLED, UL94 V-0, COLOUR REFER TO SHEET 1.

FORM-106-01-056-6 ISS 7

ELCO EUROPE (A DIVISION OF AVX LTD.) CONFIDENTIAL PROPRIETY
THE DRAWING ON THIS PRINT AND INFORMATION THEREWITH ARE
PROPRIETARY TO ELCO EUROPE (A DIVISION OF AVX LTD.) AND
SHALL NOT BE USED OR DISCLOSED IN WHOLE OR IN PART
WITHOUT ELCO EUROPE'S WRITTEN CONSENT.

SHEET 4 OF 6

Release No.
History
102869
04.05.2012
22.05.2012

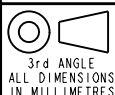

ELCO
© COPYRIGHT ELCO EUROPE
NOT TO BE DISCLOSED OR COPIED
WITHOUT WRITTEN PERMISSION

Drawn
N.C.H.
Size
CV

Description
26-28AWG IDC WIRE TO BOARD CONNECTOR
Part Number
00-9175-01_700S

DATE
03-Apr-12
Issue
B

A

B

**26-28 AWG 3 WAY IDC CONNECTOR
WIRE STOP CAPPED IDC**

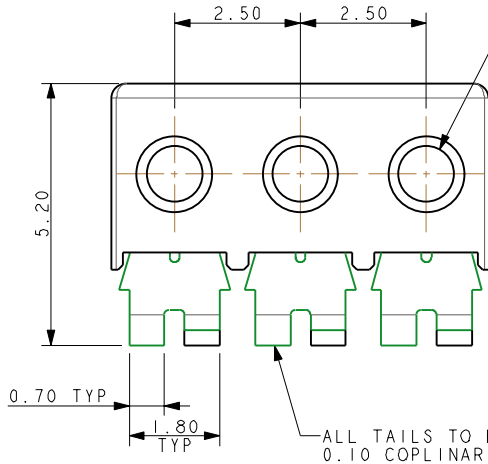
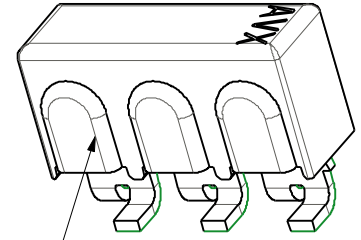
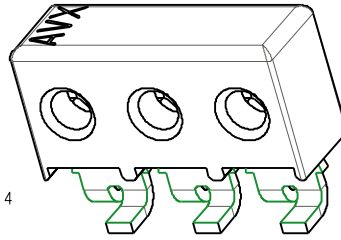
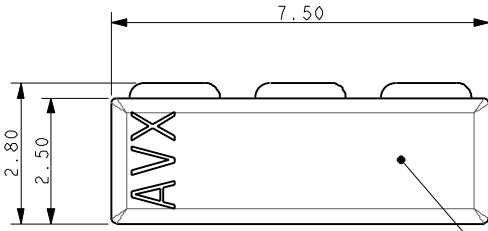

NOTE 4

WIRE STOP
NOTE 2

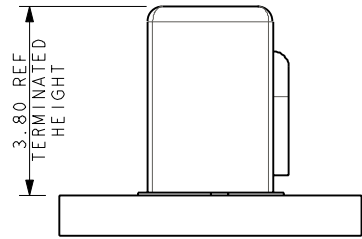
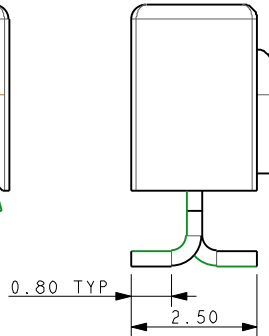

MOUNTED ON PCB

Elco Europe (A Division of AVX Ltd) CONFIDENTIAL PROPRIETY
The document on this print and information therewith are PROPRIETY
to Elco Europe (A Division of AVX Ltd) and shall not be copied
or disclosed in whole or in part without Elco Europe's written consent.

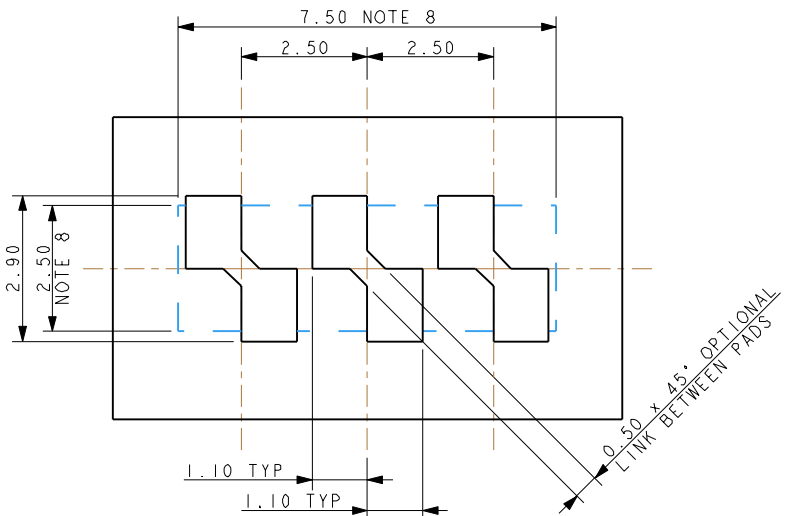
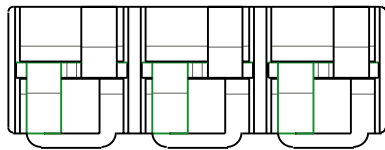

SUGGESTED PCB LAYOUT

PACKING DETAILS

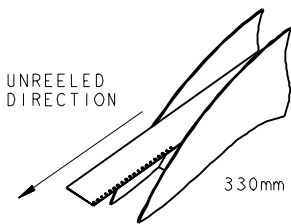

330mm DIAMETER REEL

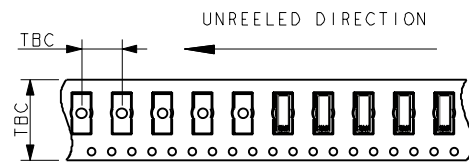

QUANTITY PER REEL 1000



NOTES :-

1. 3 WAY CONNECTOR FOR IDC WIRE TO BOARD CONNECTION, PRE-ASSEMBLED WIRE STOP CAP.
2. WIRE STOP PROTECTS END OF WIRE.
3. CONTACT/CAP TO MATCH 26AWG AND 28AWG WIRES, SOLID OR STANDED CONDUCTOR, MAXIMUM INSULATOR 1.00mm DIAMETER.
4. FLAT FACE ON TOP OF CAP TO AID PICK AND PLACE ASSEMBLY.
5. FOR FULL DETAILS REFER TO ELCO SPECIFICATION 201-01-139.
6. ASSEMBLY PROCEDURE, REFER TO APPLICATION NOTES 201-01-140.
7. GENERAL TOLERANCE ± 0.20 UNLESS STATED.
8. PACKED IN TAPE AND REEL, QUANTITY PER REEL 1000.
9. CONNECTOR OUTLINE.
10. CONTACT MATERIAL :- TIN PLATED COPPER ALLOY.
11. INSULATOR MATERIAL :- HIGH TEMPERATURE NYLON, GLASS FILLED, UL94 V-0, COLOUR REFER TO SHEET 1.

ELCO EUROPE (A DIVISION OF AVX LTD.) CONFIDENTIAL PROPRIETARY
THE DRAWING ON THIS PRINT AND INFORMATION THEREWITH ARE
PROPRIETARY TO ELCO EUROPE (A DIVISION OF AVX LTD.) AND
SHALL NOT BE USED OR DISCLOSED IN WHOLE OR IN PART
WITHOUT ELCO EUROPE'S WRITTEN CONSENT.

SHEET 5 OF 6

Release No.
History
102869
04.05.2012
22.05.2012

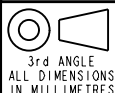

ELCO
© COPYRIGHT ELCO EUROPE
NOT TO BE DISCLOSED OR COPIED
WITHOUT WRITTEN PERMISSION

Drawn N.C.H.	Description 26-28AWG IDC WIRE TO BOARD CONNECTOR	DATE 03-Apr-12
Size CV	Part Number 00-9175-01_700S	Issue B

A

B

A

B

26-28 AWG ASSEMBLED CAPPED IDC CONNECTORS



Elco Europe (A Division of AVX Ltd) CONFIDENTIAL PROPRIETY
The document on this print and information therewith are PROPRIETY
to Elco Europe (A Division of AVX Ltd) and shall not be copied
or disclosed in whole or in part without Elco Europe's written consent.

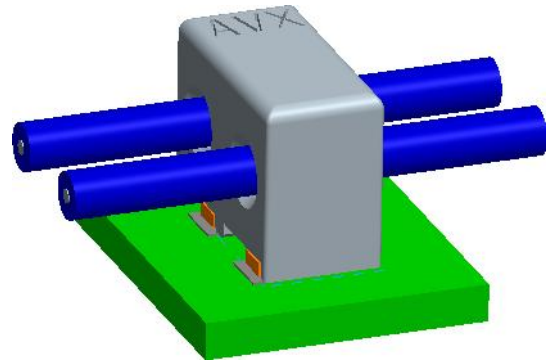
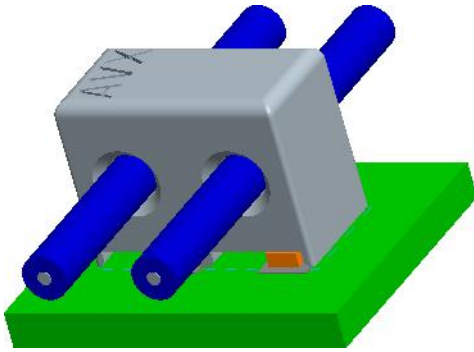

TYPICAL THROUGH WIRE ASSEMBLY

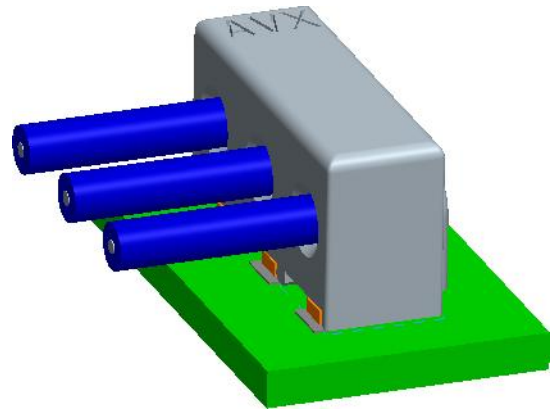
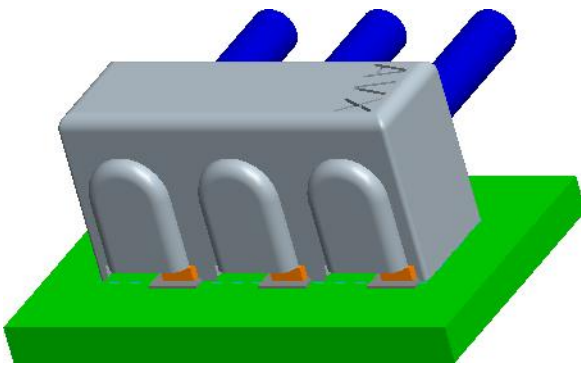

TYPICAL WIRE STOP ASSEMBLY

FORM-106-01-036-6 ISS 7

ELCO EUROPE (A DIVISION OF AVX LTD.) CONFIDENTIAL PROPRIETY
THE DRAWING ON THIS PRINT AND INFORMATION THEREWITH ARE
PROPRIETARY TO ELCO EUROPE (A DIVISION OF AVX LTD.) AND
SHALL NOT BE USED OR DISCLOSED IN WHOLE OR IN PART
WITHOUT ELCO EUROPE'S WRITTEN CONSENT.

SHEET 6 OF 6

Release No.
History
1 02869
04.05.2012
22.05.2012

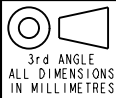

ELCO
© COPYRIGHT ELCO EUROPE
NOT TO BE DISCLOSED OR COPIED
WITHOUT WRITTEN PERMISSION

Drawn
N.C.H.
Size
CV

Description
26-28AWG IDC WIRE TO BOARD CONNECTOR
Part Number
00-9175-01_700S

DATE
03-Apr-12
Issue
B

A

B



Компания «ЭлектроПласт» предлагает заключение долгосрочных отношений при поставках импортных электронных компонентов на взаимовыгодных условиях!

Наши преимущества:

- Оперативные поставки широкого спектра электронных компонентов отечественного и импортного производства напрямую от производителей и с крупнейших мировых складов;
- Поставка более 17-ти миллионов наименований электронных компонентов;
- Поставка сложных, дефицитных, либо снятых с производства позиций;
- Оперативные сроки поставки под заказ (от 5 рабочих дней);
- Экспресс доставка в любую точку России;
- Техническая поддержка проекта, помощь в подборе аналогов, поставка прототипов;
- Система менеджмента качества сертифицирована по Международному стандарту ISO 9001;
- Лицензия ФСБ на осуществление работ с использованием сведений, составляющих государственную тайну;
- Поставка специализированных компонентов (Xilinx, Altera, Analog Devices, Intersil, Interpoint, Microsemi, Aeroflex, Peregrine, Syfer, Eurofarad, Texas Instrument, Miteq, Cobham, E2V, MA-COM, Hittite, Mini-Circuits, General Dynamics и др.);

Помимо этого, одним из направлений компании «ЭлектроПласт» является направление «Источники питания». Мы предлагаем Вам помощь Конструкторского отдела:

- Подбор оптимального решения, техническое обоснование при выборе компонента;
- Подбор аналогов;
- Консультации по применению компонента;
- Поставка образцов и прототипов;
- Техническая поддержка проекта;
- Защита от снятия компонента с производства.



Как с нами связаться

Телефон: 8 (812) 309 58 32 (многоканальный)

Факс: 8 (812) 320-02-42

Электронная почта: org@eplast1.ru

Адрес: 198099, г. Санкт-Петербург, ул. Калинина, дом 2, корпус 4, литера А.