

ISL1561

Fixed Gain Dual Port Class-G Differential xDSL Line Driver

FN7941
Rev 1.00
February 26, 2013

The ISL1561 is a fixed gain dual port class-G differential amplifier designed for driving full rate ADSL2+ and VDSL2 signals at very low power dissipation. The driver runs on a single +14V power supply and internally generates higher supply voltages when needed to enable power efficient operation for high peak-to-average ratio (PAR) ADSL2+ and VDSL2 signals.

In ADSL2+ mode of operation with full 19.8dBm transmit signal power across 100Ω line load, each port consumes only 520mW of power, while with 19.5dBm VDSL2 8b profile a port consumes 610mW of power. In VDSL2 17a mode of operation with 14.5dBm transmit power, a port will consume 411mW of power. These typical power consumption figures account for receiver hybrid loading effects and transformer losses.

The ISL1561 provides two ports of wideband, current feedback amplifiers optimized for low power consumption in xDSL systems. The drivers achieve an average upstream missing band power ratio (MBPR) distortion of better than -64dBc under 19.8dBm transmit signal power into 100Ω load. A three pin serial interface is used to program an 8-bit internal register to set each port's supply current with 0.5mA step size. This flexibility allows the DSP to optimize each port separately during modem training.

The device is supplied in a thermally-enhanced small footprint (4mmx4mm) 24 lead QFN package. The ISL1561 is specified for operation over the full -40°C to +85°C industrial temperature range and is Pb-free RoHS compliant.

Features

- Internal fixed gain of 11.6V/V to transformer (see Figure 3)
- 360mA output drive capability
- 41.8V_{P-P} differential output drive into 100Ω in class G mode
- VDSL2 8b profile MTPR of -64dBc
- VDSL2 17a profile MTPR of -60dBc
- ADSL2+, VDSL2 8b and 17a power consumption of 520mW, 610mW and 411mW respectively
- 8-bit programmable register to set supply current on each port
- 3 pin serial port interface

Applications

- Dual port ADSL2+ and VDSL2 DSLAM

Alternate Part

- ISL1591 Class AB VDSL Driver

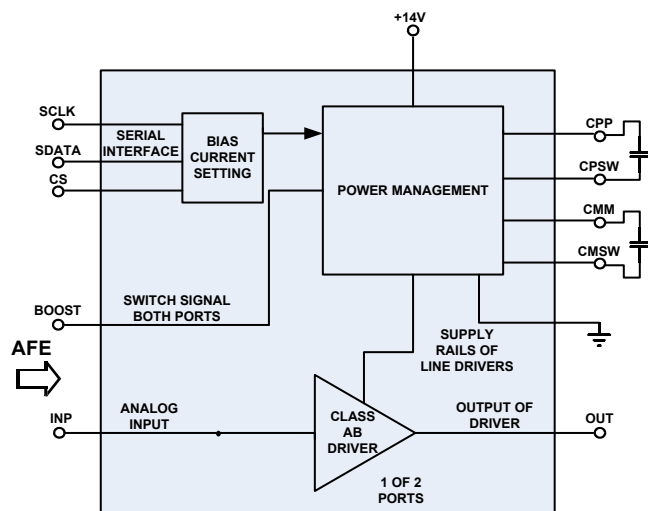

FIGURE 1. BLOCK DIAGRAM

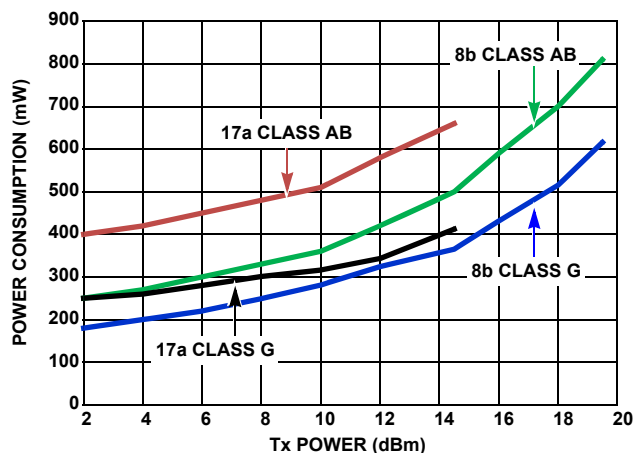
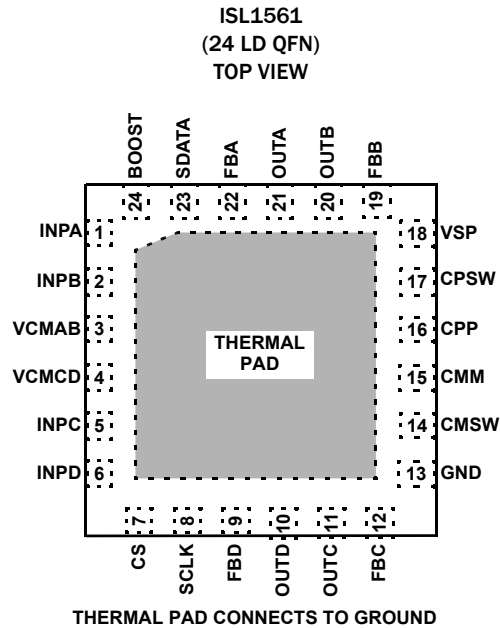

FIGURE 2. CLASS G+ vs CLASS AB DRIVER TOTAL POWER

Pin Configuration



Pin Descriptions

ISL1561 (24 Ld QFN)	PIN NAME	FUNCTION
1	INPA	Amplifier A non-inverting input
2	INPB	Amplifier B non-inverting input
3	VCMAB	Input common mode bias for port AB
4	VCMCD	Input common mode bias for port CD
5	INPC	Amplifier C non-inverting input
6	INPD	Amplifier D non-inverting input
7	CS	Chip select, low enables data input to logic
8	SCLK	Serial clock input
9	FBD	Feedback pin for amplifier D
10	OUTD	Amplifier D output
11	OUTC	Amplifier C output
12	FBC	Feedback pin for amplifier C
13	GND	Ground
14	CMSW	Internal negative boost supply
15	CMM	Internal negative supply
16	CPP	Internal positive supply
17	CPSW	Internal positive boost supply
18	VSP	Positive supply voltage
19	FBB	Feedback pin for amplifier B
20	OUTB	Amplifier B output
21	OUTA	Amplifier A output
22	FBA	Feedback pin for amplifier A
23	SDATA	Serial data write
24	BOOST	Class G control input

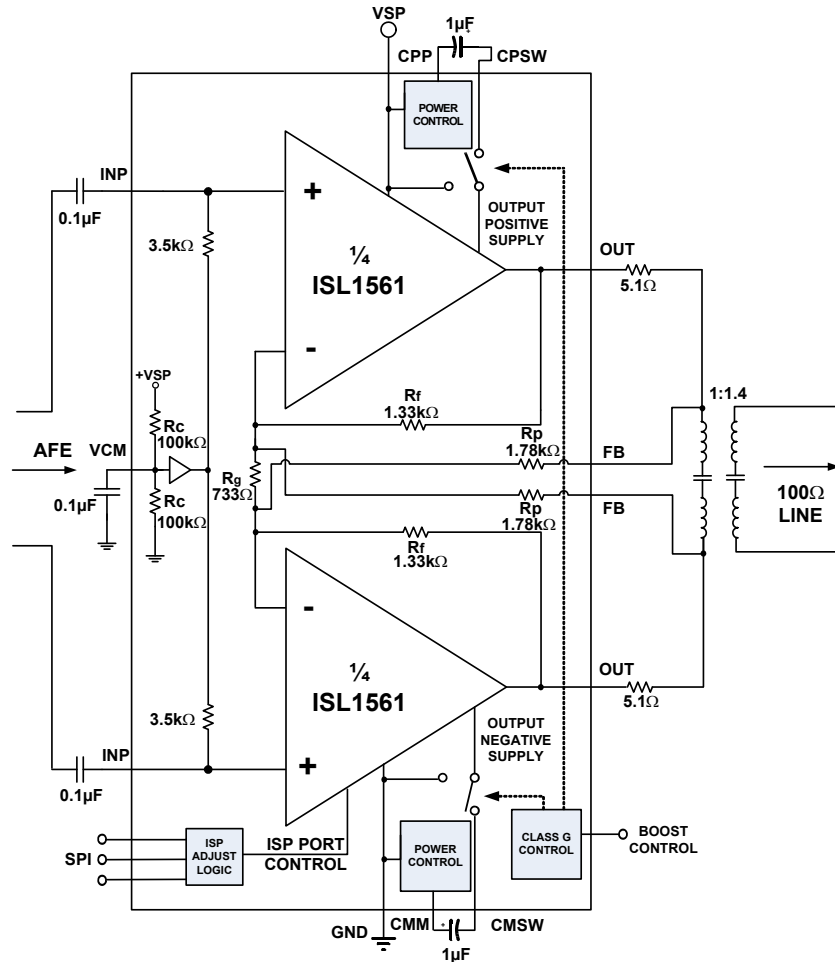

TYPICAL DIFFERENTIAL I/O LINE DRIVER (1 OF 2 PORTS)

FIGURE 3. CONNECTION DIAGRAM

Ordering Information

PART NUMBER (Notes 2, 3)	PART MARKING	OPERATING AMBIENT TEMP RANGE (°C)	PACKAGE (Pb-free)	PKG. DWG. #
ISL1561IRZ	15 61IRZ	-40 to +85	24 Ld QFN	L24.4x4H
ISL1561IRZ-T13 (Note 1)	15 61IRZ	-40 to +85	24 Ld QFN	L24.4x4H

NOTES:

1. Please refer to [TB347](#) for details on reel specifications.
2. These Intersil Pb-free plastic packaged products employ special Pb-free material sets, molding compounds/die attach materials, and 100% matte tin plate plus anneal (e3 termination finish, which is RoHS compliant and compatible with both SnPb and Pb-free soldering operations). Intersil Pb-free products are MSL classified at Pb-free peak reflow temperatures that meet or exceed the Pb-free requirements of IPC/JEDEC J STD-020.
3. For Moisture Sensitivity Level (MSL), please see device information page for [ISL1561](#). For more information on MSL please see tech brief [TB363](#).

Absolute Maximum Ratings ($T_A = +25^\circ\text{C}$)

V_S+ Voltage to GND	-0.3V to +15V
Driver V_{IN+} Voltage	.GND to V_S+
SPI and Boost Pin Voltage to GND	-0.3V to +6V
V_{CM} Voltage to GND	.GND to V_S+
Current into any Input	.8mA
Continuous Output Current for Long Term Reliability	.50mA
ESD Rating	
Human Body Model (Tested per JESD22-A114F)	3kV
Machine Model (Tested per JESD22-A115C)	300V
Charge Device Model (Tested per JESD22-C101E)	1.5kV

Thermal Information

Thermal Resistance (Typical)	θ_{JA} ($^\circ\text{C}/\text{W}$)	θ_{JC} ($^\circ\text{C}/\text{W}$)
24 Ld QFN Package (Notes 4, 5)	44	5
Maximum Junction Temperature (Plastic Package)	+150 $^\circ\text{C}$	
Power Dissipation	See Performance Curve	
Storage Temperature Range	-40 $^\circ\text{C}$ to +150 $^\circ\text{C}$	
Pb-Free Reflow Profile	see link below	
	http://www.intersil.com/pbfree/Pb-FreeReflow.asp	

Operating Conditions

Ambient Temperature Range	-40 $^\circ\text{C}$ to +85 $^\circ\text{C}$
Junction Temperature Range	-40 $^\circ\text{C}$ to +150 $^\circ\text{C}$

CAUTION: Do not operate at or near the maximum ratings listed for extended periods of time. Exposure to such conditions may adversely impact product reliability and result in failures not covered by warranty.

NOTES:

- θ_{JA} is measured in free air with the component mounted on a high effective thermal conductivity test board with "direct attach" features. See Tech Brief [TB379](#).
- For θ_{JC} , the "case temp" location is the center of the exposed metal pad on the package underside.

Electrical Specifications $V_{SP} = +14\text{V}$, $R_{L-DIFF} = 51\Omega$ differential (emulating transformer input load), Refer to Figure 3, $T_A = +25^\circ\text{C}$. Ports tested separately unless otherwise indicated.

PARAMETER	DESCRIPTION	CONDITIONS	MIN (Note 6)	TYP	MAX (Note 6)	UNIT
AC PERFORMANCE						
AV		Gain Across the Load, $R_B = 5.1\Omega$		11.6		V/V
BW	-3dB Bandwidth	$I_S = 14\text{mA}/\text{port}$, $V_O < 2V_{PP-DIFF}$		110		MHz
		$I_S = 10\text{mA}/\text{port}$, $V_O = 5V_{PP-DIFF}$		70		MHz
Gain Flatness	Small Signal Gain Flatness	$I_S = 14\text{mA}/\text{port}$, 17.6MHz		0.3		dB
		$I_S = 14\text{mA}/\text{port}$, 30MHz		0.9		dB
SR	Slew Rate	$V_{OUT} = 16V_{P-P-DIFF}$ (20% to 80%)	560	1000		V/ μs
200kHz Harmonic Distortion	2nd Harmonic	10mA/port, $V_{OUT} = 10V_{P-P-DIFF}$		-95		dBc
	3rd Harmonic	10mA/port, $V_{OUT} = 10V_{P-P-DIFF}$		-83		dBc
	THD	10mA/port, $V_{OUT} = 10V_{P-P-DIFF}$		-83		dBc
4MHz Harmonic Distortion	2nd Harmonic	10mA/port, $V_{OUT} = 10V_{P-P-DIFF}$		-80		dBc
	3rd Harmonic	10mA/port, $V_{OUT} = 10V_{P-P-DIFF}$		-75		dBc
	THD	10mA/port, $V_{OUT} = 10V_{P-P-DIFF}$		-74		dBc
MBPR	Average Missing-Band Power Ratio	26kHz to 8MHz, 5kHz Tone Spacing, $P_{LINE} = 19.5\text{dBm}$, VDSL2+ 8b, US1		-64		dBc
e_O	Output Voltage Noise	$f = 1\text{MHz}$, differential each port		110		$\text{nV}/\sqrt{\text{Hz}}$
e_{O-CM}	Common Mode Output Noise at each Port Pair	$f = 1\text{MHz}$		190		$\text{nV}/\sqrt{\text{Hz}}$
CONTROL FEATURES						
V_{HIGH}	Input High Voltage	SCLK, SDATA, CS, BOOST inputs	2.3			V
V_{LOW}	Input Low Voltage	SCLK, SDATA, CS, BOOST inputs			0.8	V
I_{HIGH}	Input High Current for Pull-up Pins CS, BOOST	$V_{IN} = 3.3\text{V}$	-28	-23	-18	μA
I_{HIGH}	Input High Current for Pull-down Pins SCLK, SDATA	$V_{IN} = 3.3\text{V}$	40	50	60	μA

Electrical Specifications $V_{SP} = +14V$, $R_{L-DIFF} = 51\Omega$ differential (emulating transformer input load), Refer to Figure 3, $T_A = +25^\circ C$. Ports tested separately unless otherwise indicated. (Continued)

PARAMETER	DESCRIPTION	CONDITIONS	MIN (Note 6)	TYP	MAX (Note 6)	UNIT
I_{LOW}	Input Low Current for Pull-up Pins CS, BOOST	$V_{IN} = 0V$	-88	-73	-58	μA
I_{LOW}	Input Low Current for Pull-down Pins SCLK, SDATA	$V_{IN} = 0V$	-0.2	0	+0.2	μA
SUPPLY CHARACTERISTICS						
V_S	Operating Supply Voltage		+10	+14	+14.7	V
V_{CPP}	Voltage on the CPP Pin	BOOST = 0V (Class AB)		7		V
V_{CPSW}	Maximum Voltage on the CPSW Pin	BOOST = 0V (Class AB)		14		V
V_{CMM}	Voltage on the CMM Pin	BOOST = 0V (Class AB)		7		V
V_{CMSW}	Minimum Voltage on the CMSW Pin	BOOST = 0V (Class AB)		0		V
I_{SP}	Positive Supply Current per Port	All outputs at 0V, BOOST = 0V, SDATA = 8'h7F for Registers 3 and 7	17.5	19.5	21.5	mA
		All outputs at 0V, BOOST = 0V, SDATA = 8'h1C for Registers 3 and 7	9.8	10.3	10.8	mA
		All outputs at 0V, BOOST = 0V, SDATA = 8'h0F for Registers 3 and 7	6.8	7.2	7.6	mA
I_{SP} (Power-down)	Supply Current per Port	All outputs at 0V, BOOST = 0V, SDATA = 8'h80 for Registers 3 and 7	2.0	2.5	3.0	mA
OUTPUT CHARACTERISTICS						
V_{OUT}	Loaded Output Swing High (Single-ended to GND)	$R_L = 51\Omega$, Class AB (see Figure 3)	11.9	12.4		V
	Loaded Output Swing High (Single-ended to GND)	$R_L = 51\Omega$, Class AB (see Figure 3)		1.6	2.1	V
I_{OL}	Linear Output Current	$R_L = 10\Omega$, $f = 100kHz$, THD = -60dBc (5 Ω differential)		± 360		mA
V_{OS-DM}	Differential Output Offset Voltage	SDATA = 8'h1C	-125	18	+125	mV
V_{OS-CM}	Common Mode Output Offset Voltage	SDATA = 8'h1C (Offset from input VCM)	6.85		7.09	mV
INPUT CHARACTERISTICS						
CMIR	Common Mode Input Range at each of the 4 Non-inverting Input Pins	Class AB	+4.5		+9.5	V
CMRR	DC Common Mode Rejections for each Port. $V_{CM} = +4.5V$ to $+9.5V$	V_{CM} to Differential Mode Output (Input Referred) $I_{SP} = 10mA/port$		66		dB
		V_{CM} to Common Mode Output (Output Referred) $I_{SP} = 10mA/port$		40		dB
PSRR	DC Power Supply Rejections for each Port to Differential Output (Input Referred)	$+V_S = +7V$ to $+14V$, GND = 0V, $I_{SP} = 10mA/port$		74		dB
	DC Power Supply Rejections for each Port to Common Mode Output (Output Referred)	$+V_S = +7V$ to $+14V$, GND = 0V, $I_{SP} = 10mA/port$		55		dB
RIN	Input Resistance	Differential	5.0	6.0	7.1	k Ω
DIGITAL						
f_{CLK}	Clock Frequency			0.1	10	MHz

NOTE:

6. Compliance to datasheet limits is assured by one or more methods: production test, characterization and/or design.

Typical Performance Curves

$V_{CC} = +14V$, $R_b = 5.1\Omega$, Gain at the Load = $11.6V/V$ (Differential), $R_{LOAD} = 51\Omega$, $T_A = +25^\circ C$, Unless otherwise noted.

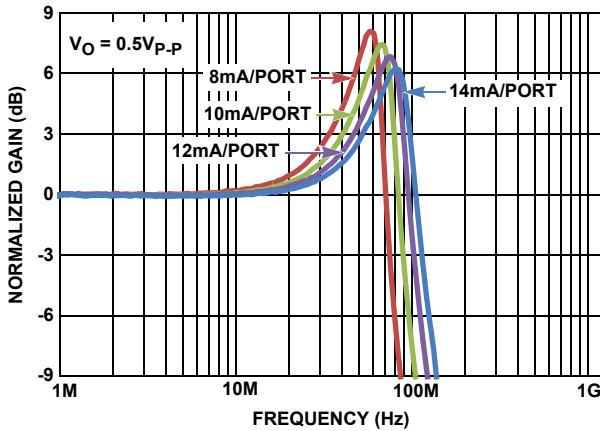

FIGURE 4. SMALL SIGNAL FREQUENCY RESPONSE vs BIAS CURRENT

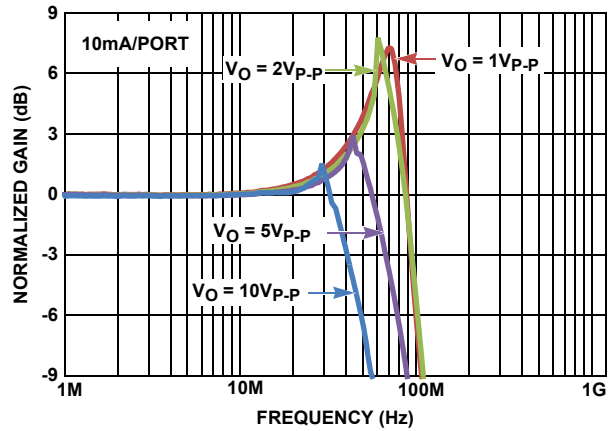

FIGURE 5. LARGE SIGNAL FREQUENCY RESPONSE

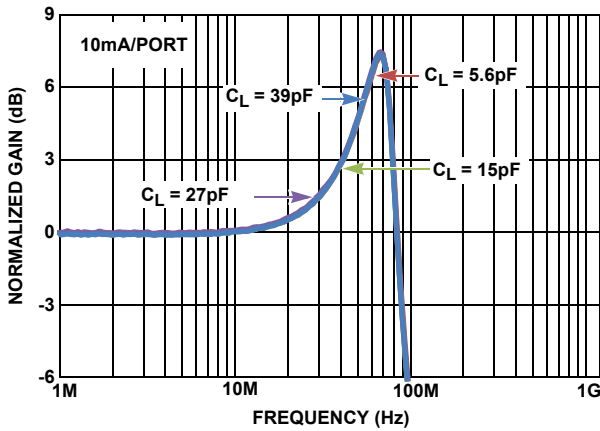

FIGURE 6. SMALL SIGNAL FREQUENCY RESPONSE vs C_{LOAD}

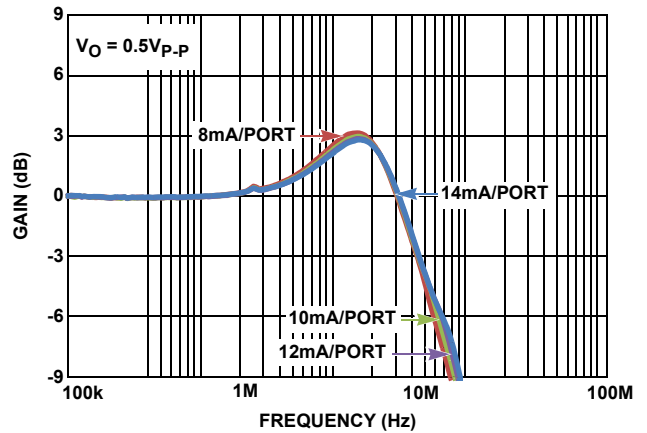

FIGURE 7. COMMON MODE SMALL SIGNAL RESPONSE vs BIAS CURRENT

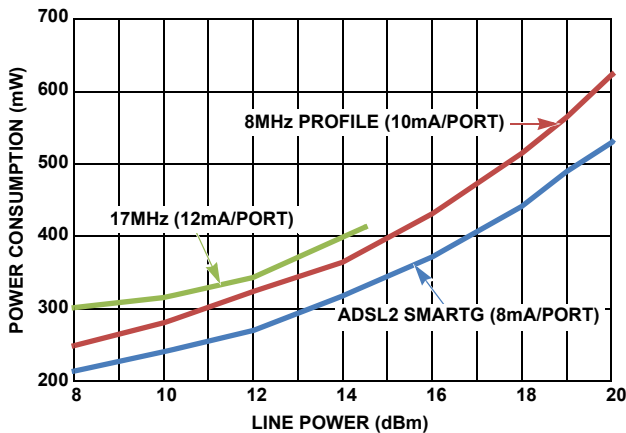

FIGURE 8. POWER CONSUMPTION vs LINE POWER

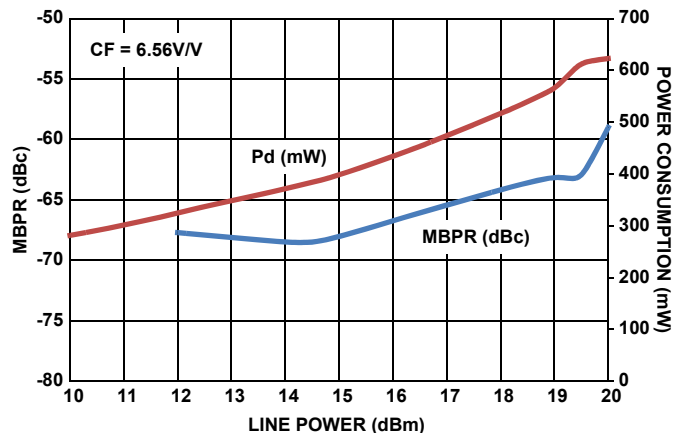

FIGURE 9. VDSL2+ 8b Avg. MBPR US1 vs LINE POWER

Typical Performance Curves

$V_{CC} = +14V$, $R_b = 5.1\Omega$, Gain at the Load = 11.6V/V (Differential), $R_{LOAD} = 51\Omega$, $T_A = +25^\circ C$, Unless otherwise noted. (Continued)

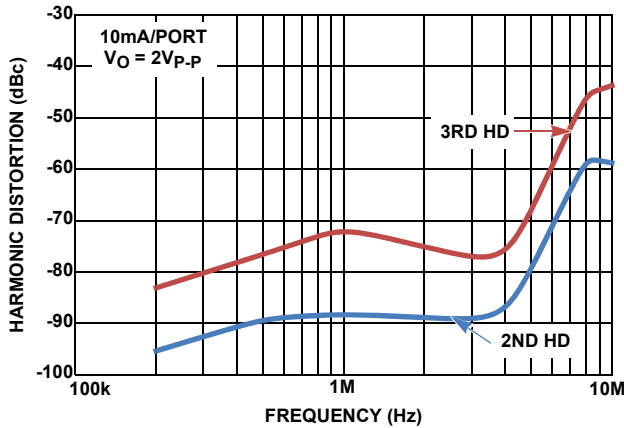

FIGURE 10. HARMONIC DISTORTION vs FREQUENCY

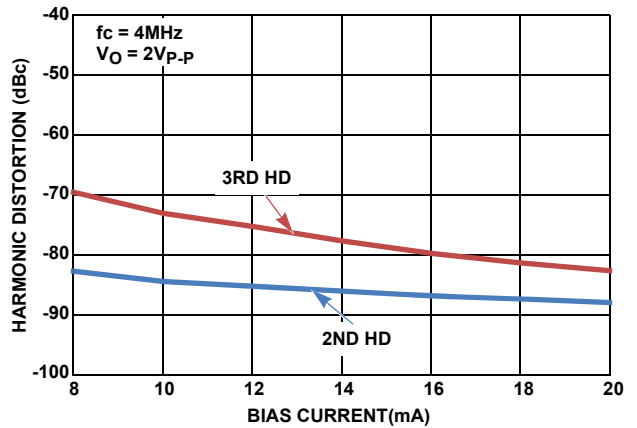

FIGURE 11. HARMONIC DISTORTION vs BIAS CURRENT

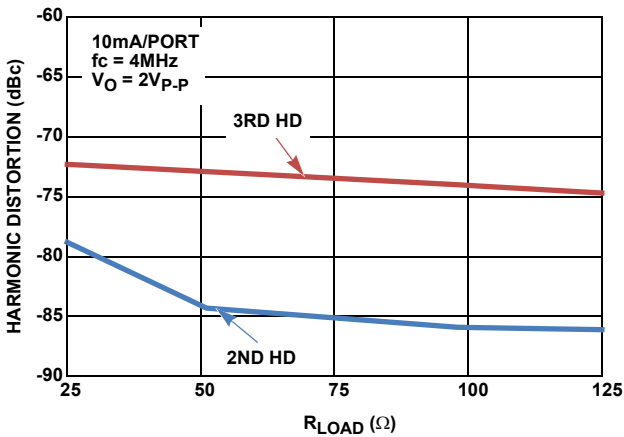

FIGURE 12. HARMONIC vs R_{LOAD}

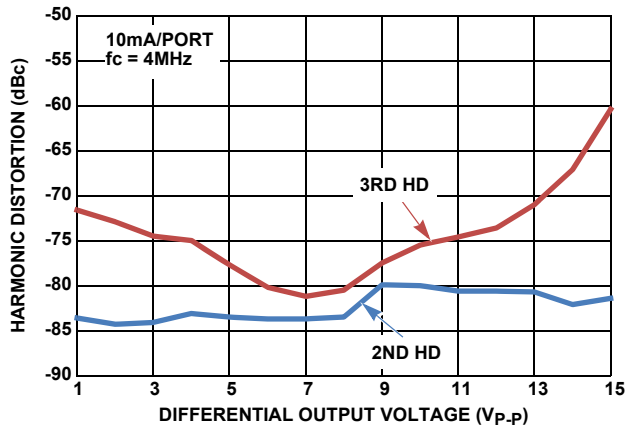

FIGURE 13. HARMONIC DISTORTION vs OUTPUT AMPLITUDE

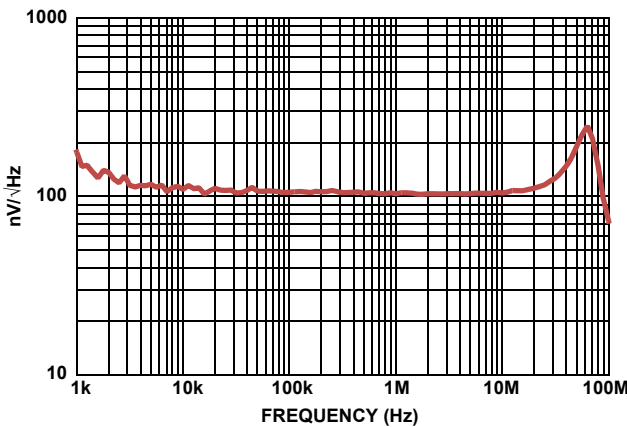

FIGURE 14. DIFFERENTIAL OUTPUT VOLTAGE NOISE

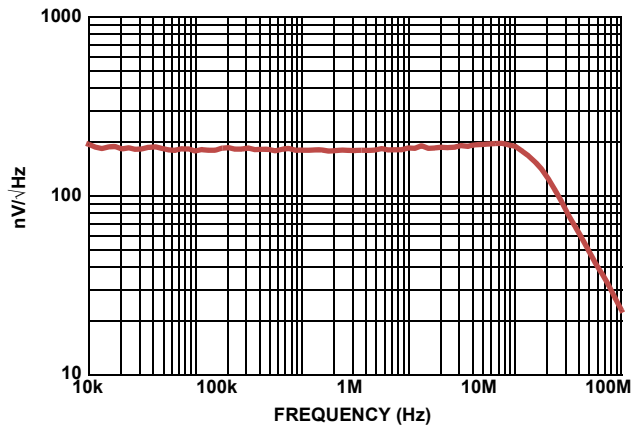

FIGURE 15. COMMON MODE OUTPUT VOLTAGE NOISE

Typical Performance Curves

$V_{CC} = +14V$, $R_b = 5.1\Omega$, Gain at the Load = 11.6V/V (Differential), $R_{LOAD} = 51\Omega$, $T_A = +25^\circ C$, Unless otherwise noted. (Continued)

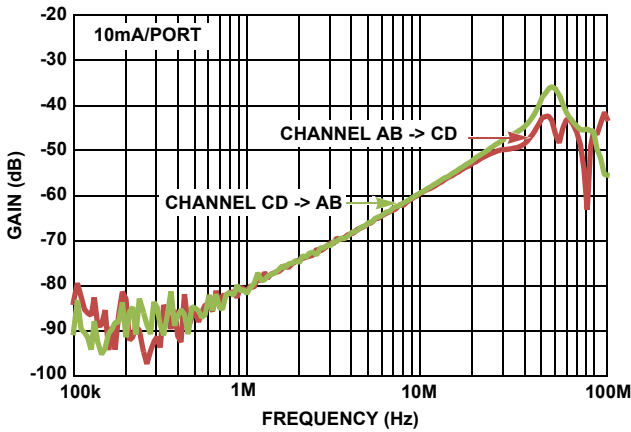

FIGURE 16. CHANNEL-TO-CHANNEL CROSSTALK

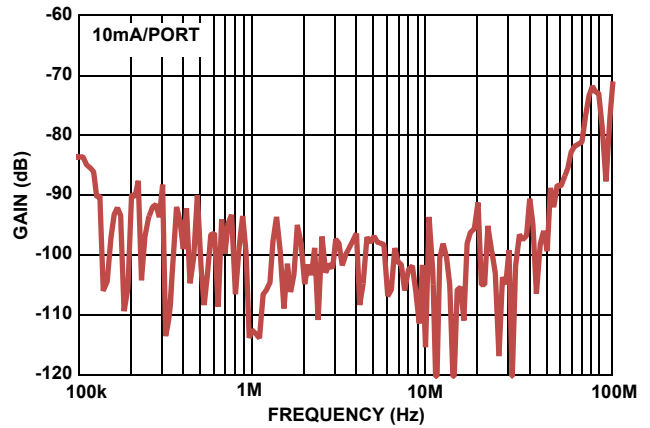

FIGURE 17. OFF-ISOLATION

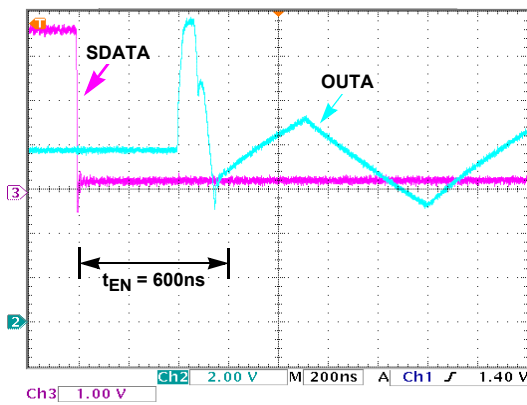

FIGURE 18. ENABLE RESPONSE

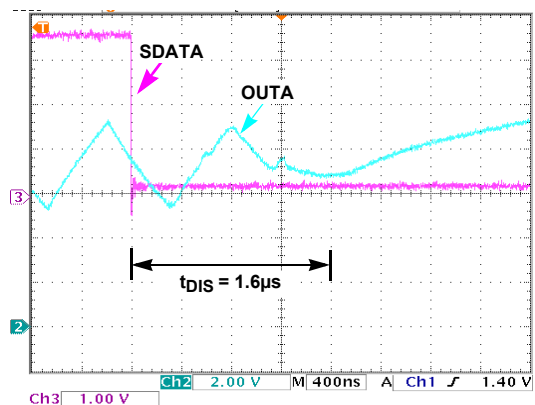

FIGURE 19. DISABLE RESPONSE

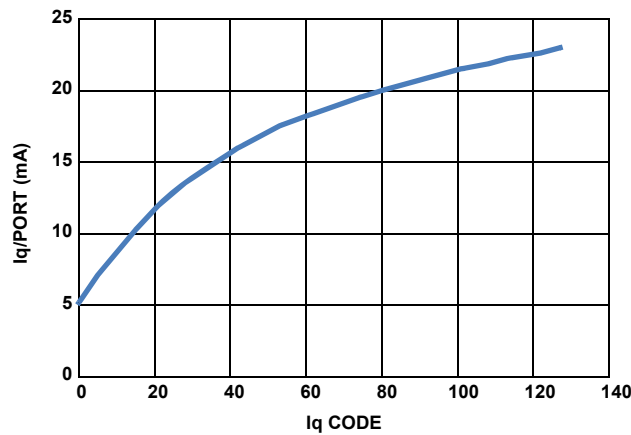

FIGURE 20. QUIESCENT CURRENT PER PORT vs CODES

Typical Performance Curves

$V_{CC} = +14V$, $R_b = 5.1\Omega$, Gain at the Load = 11.6V/V (Differential), $R_{LOAD} = 51\Omega$,

$T_A = +25^\circ C$, Unless otherwise noted. (Continued)

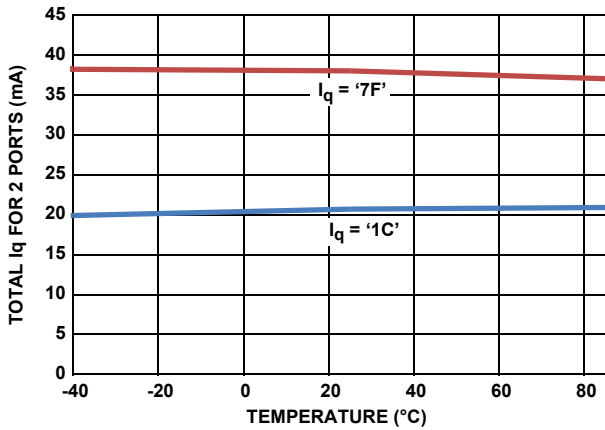

FIGURE 21. QUIESCENT CURRENT vs TEMPERATURE

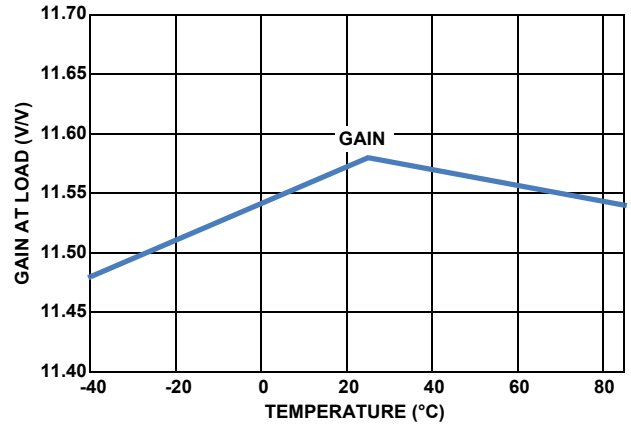

FIGURE 22. GAIN AT LOAD vs TEMPERATURE

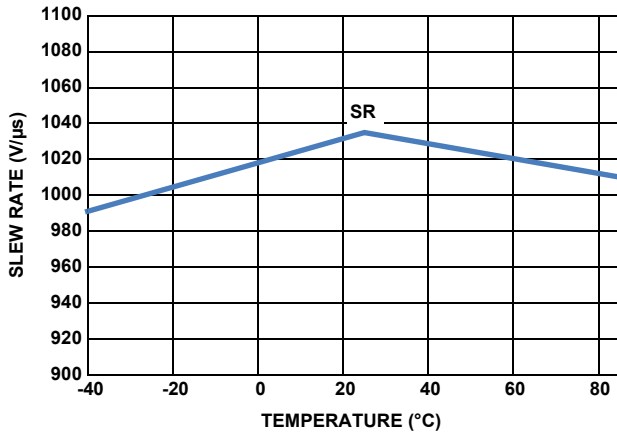

FIGURE 23. SLEW RATE vs TEMPERATURE

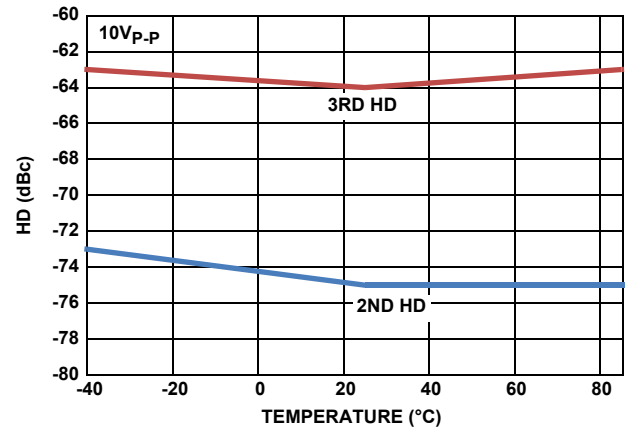

FIGURE 24. 4MHz HARMONIC DISTORTION vs TEMPERATURE

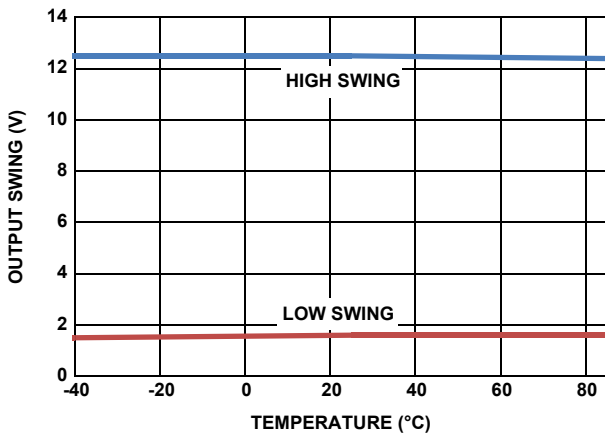

FIGURE 25. OUTPUT SWING vs TEMPERATURE

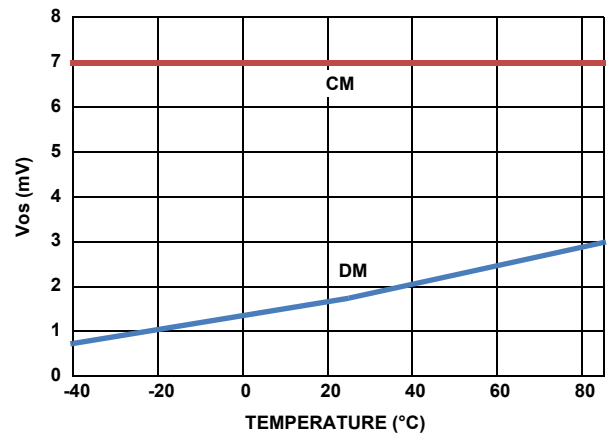

FIGURE 26. OUTPUT OFFSET CM AND DM vs TEMPERATURE

General Description

The ISL1561 is a class G amplifier designed to reduce power consumption in ADSL2+ and VDSL2 applications compared to class AB. With the high PAR used for xDSL signals, a supply voltage of +14V can be used for the majority of the small amplitude cycles while boosting to a supply voltage of +28V can be used for the few high amplitude cycles.

Digital Interface

A 12-bit serial port interface is used to program ISL1561. The first bit defines the write (1'b1) and read (1'b0) operation to the register. The following 3-bit calls the registers. The last 8-bit programs the registers. Default start-up for ISL1561 is in disable mode with boost and CS pins having internal pull ups and SCLK and SDATA pins having internal pull downs. ISL1561 can only be programmed through the SPI when CS is set low.

Register Listing

ADDRESS	FUNCTION	BIT	DESCRIPTION
3'h3	Setting of quiescent current of port AB	[7]	Boost disable
		[6:0]	Program quiescent current of port AB.
3'h7	Setting of quiescent current of port CD	[7]	Boost disable
		[6:0]	Program quiescent current of port CD.

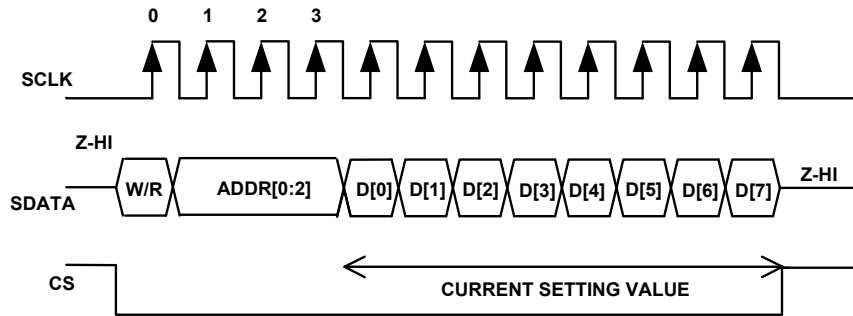

FIGURE 27. 12 BITS SERIAL ADDRESSING DIAGRAM

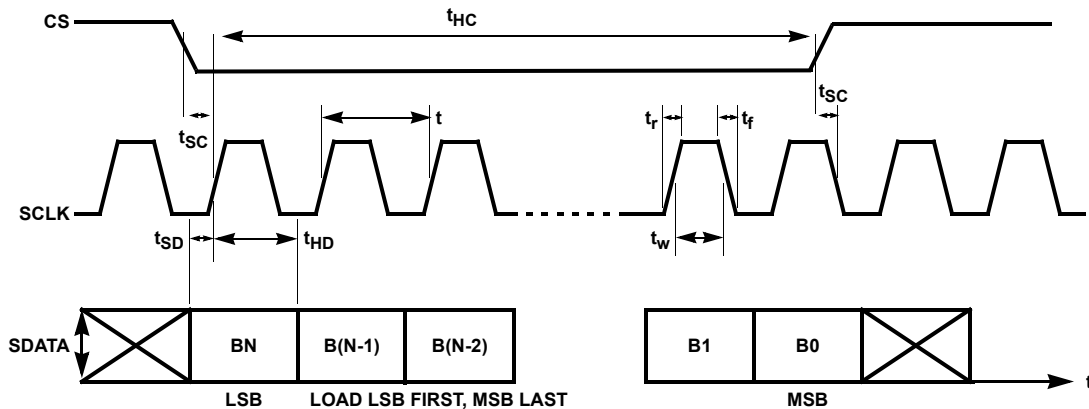

FIGURE 28. 12 BITS SERIAL ADDRESSING DIAGRAM

TABLE 1. SERIAL TIMING DIAGRAM

PARAMETER	RECOMMENDED OPERATING RANGE	DESCRIPTION
t	≥100ns	Clock Period
t _r /t _f	0.05*t	Clock Rise/Clock Fall
t _{HC}	≥7ns	Data Hold Time
t _{SD}	≥10ns	Data Setup Time
t _{HC}	≥2.8ns	CS Hold Time
t _{sc}	≥0.5ns	CS Setup Time
t _w	0.50*t	Clock Pulse Width

Boost Control

Table 2 summarizes the logic of register MSB on boost operations followed by Figure 29 with the recommended look ahead timing for the boost signal.

TABLE 2. REGISTER MSB ON BOOST OPERATION

Reg3 8'h[7]	Reg7 8'h[7]	BOOST PIN	BOOST OPERATION
0	X	1	1
X	0	1	1
1	1	X	0
X	X	0	0

NOTE: X = do not care

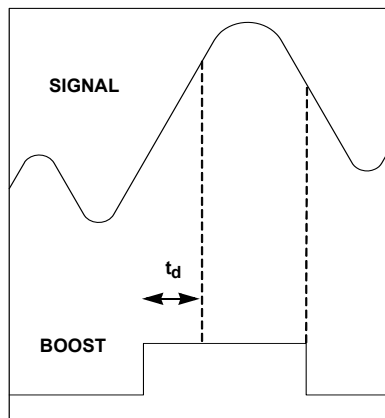

FIGURE 29. SERIAL TIMING DIAGRAM

TABLE 3. EXTERNAL BOOST SIGNAL TIMING PARAMETERS

PARAMETER	RECOMMENDED OPERATING RANGE	DESCRIPTION
t _d	100ns	Look ahead boost

Revision History

The revision history provided is for informational purposes only and is believed to be accurate, but not warranted. Please go to web to make sure you have the latest revision.

DATE	REVISION	CHANGE
January 24, 2013	FN7941.1	Changed MIN/MAX specs for "Differential Output Offset Voltage" on page 5 from -75/75mV to -125/125mV.
November 21, 2012		Added resistor values to Figure 3 on page 3. Edited table heading for columns 1 and 2 in Table 2 on page 11.
October 5, 2012	FN7941.0	Initial Release.

About Intersil

Intersil Corporation is a leader in the design and manufacture of high-performance analog, mixed-signal and power management semiconductors. The company's products address some of the fastest growing markets within the industrial and infrastructure, personal computing and high-end consumer markets. For more information about Intersil or to find out how to become a member of our winning team, visit our website and career page at www.intersil.com.

For a complete listing of Applications, Related Documentation and Related Parts, please see the respective product information page. Also, please check the product information page to ensure that you have the most updated datasheet: [ISL1561](http://www.intersil.com/datasheet/ISL1561)

To report errors or suggestions for this datasheet, please go to: www.intersil.com/askourstaff

Reliability reports are available from our website at: <http://rel.intersil.com/reports/search.php>

© Copyright Intersil Americas LLC 2012-2013. All Rights Reserved.
All trademarks and registered trademarks are the property of their respective owners.

For additional products, see www.intersil.com/en/products.html

Intersil products are manufactured, assembled and tested utilizing ISO9001 quality systems as noted in the quality certifications found at www.intersil.com/en/support/qualandreliability.html

Intersil products are sold by description only. Intersil may modify the circuit design and/or specifications of products at any time without notice, provided that such modification does not, in Intersil's sole judgment, affect the form, fit or function of the product. Accordingly, the reader is cautioned to verify that datasheets are current before placing orders. Information furnished by Intersil is believed to be accurate and reliable. However, no responsibility is assumed by Intersil or its subsidiaries for its use; nor for any infringements of patents or other rights of third parties which may result from its use. No license is granted by implication or otherwise under any patent or patent rights of Intersil or its subsidiaries.

For information regarding Intersil Corporation and its products, see www.intersil.com

Package Outline Drawing

L24.4x4H

24 LEAD QUAD FLAT NO-LEAD PLASTIC PACKAGE

Rev 0, 09/11

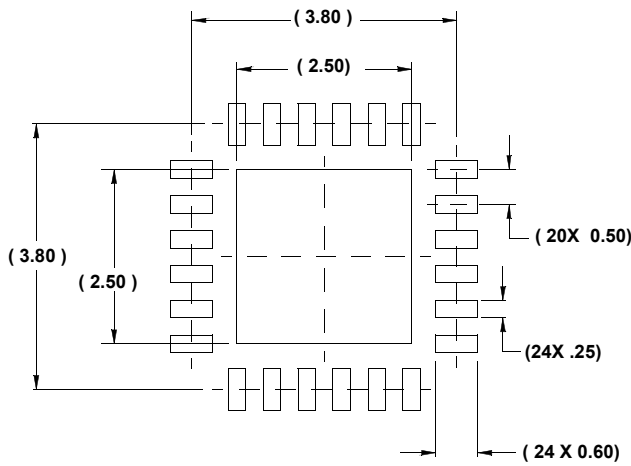
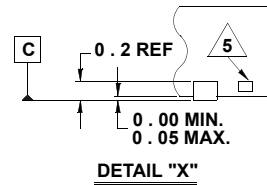
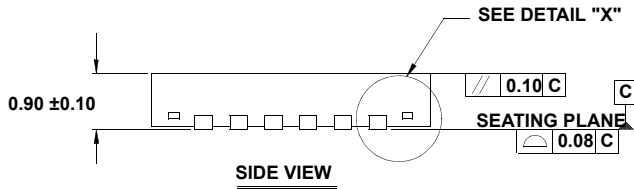
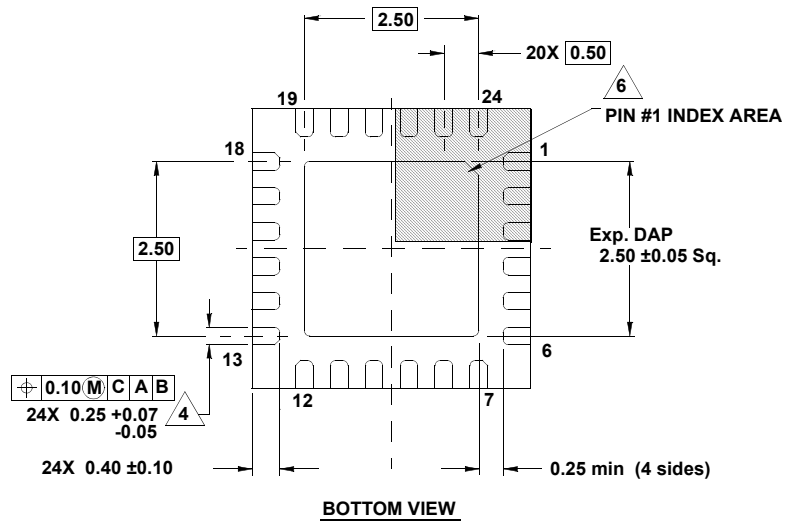
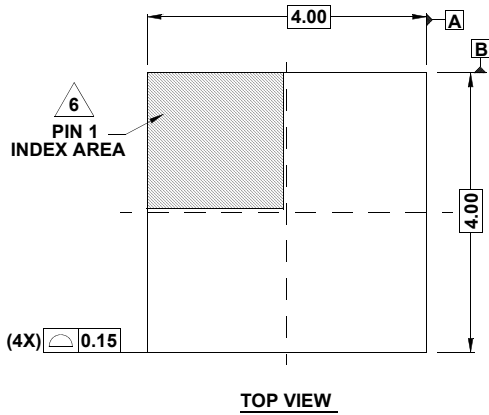

NOTES:

1. Dimensions are in millimeters.
Dimensions in () for Reference Only.
2. Dimensioning and tolerancing conform to AMSEY14.5m-1994.
3. Unless otherwise specified, tolerance : Decimal ± 0.05
4. Dimension applies to the metallized terminal and is measured between 0.15mm and 0.30mm from the terminal tip.
5. Tiebar shown (if present) is a non-functional feature.
6. The configuration of the pin #1 identifier is optional, but must be located within the zone indicated. The pin #1 identifier may be either a mold or mark feature.
7. Compliant to JEDEC MO-220 VGGD-8



Компания «ЭлектроПласт» предлагает заключение долгосрочных отношений при поставках импортных электронных компонентов на взаимовыгодных условиях!

Наши преимущества:

- Оперативные поставки широкого спектра электронных компонентов отечественного и импортного производства напрямую от производителей и с крупнейших мировых складов;
- Поставка более 17-ти миллионов наименований электронных компонентов;
- Поставка сложных, дефицитных, либо снятых с производства позиций;
- Оперативные сроки поставки под заказ (от 5 рабочих дней);
- Экспресс доставка в любую точку России;
- Техническая поддержка проекта, помощь в подборе аналогов, поставка прототипов;
- Система менеджмента качества сертифицирована по Международному стандарту ISO 9001;
- Лицензия ФСБ на осуществление работ с использованием сведений, составляющих государственную тайну;
- Поставка специализированных компонентов (Xilinx, Altera, Analog Devices, Intersil, Interpoint, Microsemi, Aeroflex, Peregrine, Syfer, Eurofarad, Texas Instrument, Miteq, Cobham, E2V, MA-COM, Hittite, Mini-Circuits, General Dynamics и др.);

Помимо этого, одним из направлений компании «ЭлектроПласт» является направление «Источники питания». Мы предлагаем Вам помощь Конструкторского отдела:

- Подбор оптимального решения, техническое обоснование при выборе компонента;
- Подбор аналогов;
- Консультации по применению компонента;
- Поставка образцов и прототипов;
- Техническая поддержка проекта;
- Защита от снятия компонента с производства.



Как с нами связаться

Телефон: 8 (812) 309 58 32 (многоканальный)

Факс: 8 (812) 320-02-42

Электронная почта: org@eplast1.ru

Адрес: 198099, г. Санкт-Петербург, ул. Калинина, дом 2, корпус 4, литера А.