



### Features

- Logic Level Input
- Input Protection (ESD)
- Thermal shutdown
- Green product (RoHS compliant)
- Overload protection
- Short circuit protection
- Overvoltage protection
- Current limitation
- Analog driving possible

### Product Summary

Drain source voltage	$V_{DS}$	42	V
On-state resistance	$R_{DS(on)}$	28	m $\Omega$
Nominal load current	$I_{D(Nom)}$	4.6	A
Clamping energy	$E_{AS}$	3.5	J

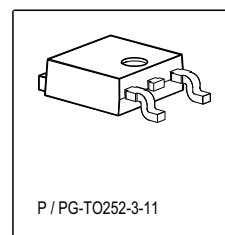

### Application

- All kinds of resistive, inductive and capacitive loads in switching or linear applications
- $\mu$ C compatible power switch for 12 V DC applications
- Replaces electromechanical relays and discrete circuits

### General Description

N channel vertical power FET in Smart SIPMOS<sup>®</sup> technology. Fully protected by embedded protection functions.

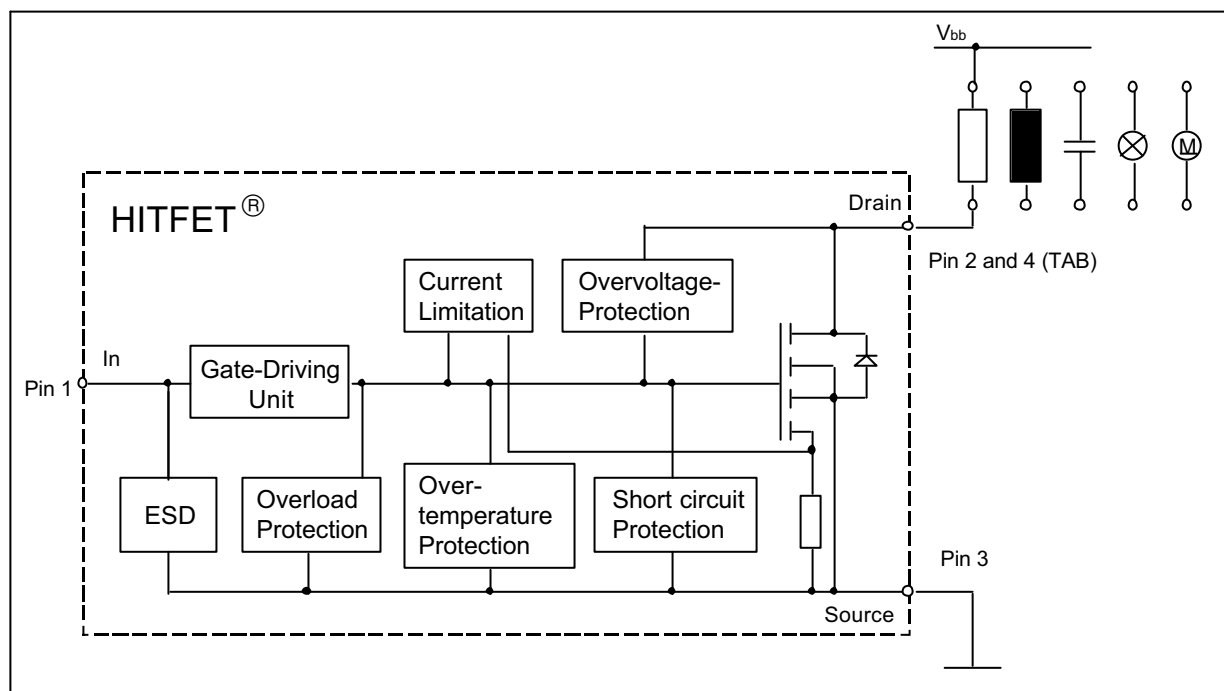

**Maximum Ratings at  $T_j = 25\text{ °C}$ , unless otherwise specified <sup>1)</sup>**

Parameter	Symbol	Value	Unit
Drain source voltage	$V_{DS}$	42	V
Drain source voltage for short circuit protection $T_j = -40 \dots +150\text{ °C}$	$V_{DS(SC)}$	28	
Continuous input current $-0.2V \leq V_{IN} \leq 10V$ $V_{IN} < -0.2V$ or $V_{IN} > 10V$	$I_{IN}$	no limit $ I_{IN}  \leq 2$	mA
Operating temperature	$T_j$	$-40 \dots +150$	$^{\circ}\text{C}$
Storage temperature	$T_{stg}$	$-55 \dots +150$	
Power dissipation <sup>4)</sup> $T_C = 85\text{ °C}$ 6cm <sup>2</sup> cooling area, $T_A = 85\text{ °C}$	$P_{tot}$	59 1.1	W
Unclamped single pulse inductive energy <sup>1)</sup>	$E_{AS}$	3.5	J
Load dump protection $V_{LoadDump}^{2)} = V_A + V_S$ $V_{IN} = 0$ and $10\text{ V}$ , $t_d = 400\text{ ms}$ , $R_l = 2\text{ }\Omega$ , $R_L = 3\text{ }\Omega$ , $V_A = 13.5\text{ V}$	$V_{LD}$	67.5	V
Electrostatic discharge voltage (Human Body Model) according to ANSI/ESDA/JEDEC JS-001 (1.5 k $\Omega$ , 100 pF)	$V_{ESD}$	2	kV

**Thermal resistance**

junction - case:	$R_{thJC}$	1.1	K/W
SMD: junction - ambient @ min. footprint @ 6 cm <sup>2</sup> cooling area <sup>3)</sup>	$R_{thJA}$	115 55	

<sup>1)</sup> Not subject to production test, specified by design.

<sup>2)</sup>  $V_{Loaddump}$  is setup without the DUT connected to the generator per ISO 7637-1 and DIN 40839

<sup>3)</sup> Device on 50mm\*50mm\*1.5mm epoxy PCB FR4 with 6cm<sup>2</sup> (one layer, 70 $\mu\text{m}$  thick) copper area for drain connection. PCB mounted vertical without blown air.

<sup>4)</sup> Not subject to production test, calculated by  $R_{thJA}/R_{thJC}$  and maximum allowed junction temperature

**Electrical Characteristics**

Parameter at $T_j = 25\text{ °C}$ , unless otherwise specified	Symbol	Values			Unit
		min.	typ.	max.	
<b>Characteristics</b>					
Drain source clamp voltage $T_j = -40 \dots +150\text{ °C}$ , $I_D = 10\text{ mA}$	$V_{DS(AZ)}$	42	-	55	V
Off-state drain current $T_j = -40 \dots +150\text{ °C}$ $V_{DS} = 32\text{ V}$ , $V_{IN} = 0\text{ V}$	$I_{DSS}$	-	1.5	20	$\mu\text{A}$
Input threshold voltage $I_D = 2.4\text{ mA}$ , $T_j = 25\text{ °C}$ $I_D = 2.4\text{ mA}$ , $T_j = 150\text{ °C}$	$V_{IN(th)}$	1.3 0.8	1.7 -	2.2 -	V
On state input current	$I_{IN(on)}$	-	10	30	$\mu\text{A}$
On-state resistance $V_{IN} = 5\text{ V}$ , $I_D = 4.6\text{ A}$ , $T_j = 25\text{ °C}$ $V_{IN} = 5\text{ V}$ , $I_D = 4.6\text{ A}$ , $T_j = 150\text{ °C}$	$R_{DS(on)}$	- -	27 54	34 68	$\text{m}\Omega$
On-state resistance $V_{IN} = 10\text{ V}$ , $I_D = 4.6\text{ A}$ , $T_j = 25\text{ °C}$ $V_{IN} = 10\text{ V}$ , $I_D = 4.6\text{ A}$ , $T_j = 150\text{ °C}$	$R_{DS(on)}$	- -	23 46	28 56	
Nominal load current <sup>1)</sup> $T_j < 150\text{ °C}$ , $V_{IN} = 10\text{ V}$ , $T_A = 85\text{ °C}$ , SMD <sup>2)</sup>	$I_{D(Nom)}$	4.6	-	-	A
Nominal load current <sup>1)</sup> $V_{IN} = 10\text{ V}$ , $V_{DS} = 0.5\text{ V}$ , $T_C = 85\text{ °C}$ , $T_j < 150\text{ °C}$	$I_{D(ISO)}$	12.6	-	-	
Current limit (active if $V_{DS} > 2.5\text{ V}$ ) <sup>3)</sup> $V_{IN} = 10\text{ V}$ , $V_{DS} = 12\text{ V}$ , $t_m = 200\text{ }\mu\text{s}$	$I_{D(lim)}$	30	45	55	

<sup>1</sup> Not subject to production test, calculated by  $R_{thJA}/R_{thJC}$  and  $R_{DS(on)}$

<sup>2</sup> @  $6\text{ cm}^2$  cooling area

<sup>3</sup> Device switched on into existing short circuit (see diagram Determination of  $I_{D(lim)}$ ). If the device is in on condition and a short circuit occurs, these values might be exceeded for max.  $50\text{ }\mu\text{s}$ .

**Electrical Characteristics**

Parameter at $T_j = 25\text{ °C}$ , unless otherwise specified	Symbol	Values			Unit
		min.	typ.	max.	

**Dynamic Characteristics**

Turn-on time $V_{IN}$ to 90% $I_D$ : $R_L = 4.7\ \Omega$ , $V_{IN} = 0$ to 10 V, $V_{bb} = 12$ V	$t_{on}$	-	60	120	$\mu\text{s}$
Turn-off time $V_{IN}$ to 10% $I_D$ : $R_L = 4.7\ \Omega$ , $V_{IN} = 10$ to 0 V, $V_{bb} = 12$ V	$t_{off}$	-	60	120	
Slew rate on 70 to 50% $V_{bb}$ : $R_L = 4.7\ \Omega$ , $V_{IN} = 0$ to 10 V, $V_{bb} = 12$ V	$-dV_{DS}/dt_{on}$	-	0.3	1.5	V/ $\mu\text{s}$
Slew rate off 50 to 70% $V_{bb}$ : $R_L = 4.7\ \Omega$ , $V_{IN} = 10$ to 0 V, $V_{bb} = 12$ V	$dV_{DS}/dt_{off}$	-	0.3	1.5	

**Protection Functions<sup>1)</sup>**

Thermal overload trip temperature	$T_{jit}$	150	175	-	$^{\circ}\text{C}$
Input current protection mode	$I_{IN(Prot)}$	-	220	400	$\mu\text{A}$
Input current protection mode $T_j = 150\text{ °C}$	$I_{IN(Prot)}$	-	180	400	
Unclamped single pulse inductive energy <sup>2)</sup> $I_D = 4.6$ A, $T_j = 25\text{ °C}$ , $V_{bb} = 12$ V	$E_{AS}$	3.5	-	-	J

**Inverse Diode**

Inverse diode forward voltage $I_F = 51$ A, $t_m = 250\ \mu\text{s}$ , $V_{IN} = 0$ V, $t_P = 300\ \mu\text{s}$	$V_{SD}$	-	1.0	-	V
---	----------	---	-----	---	---

<sup>1)</sup>Integrated protection functions are designed to prevent IC destruction under fault conditions described in the data sheet. Fault conditions are considered as "outside" normal operating range. Protection functions are not designed for continuous repetitive operation.

<sup>2)</sup> Not tested, specified by design.

## Block diagram

### Terms

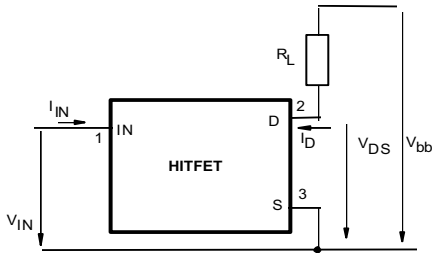

### Inductive and overvoltage output clamp

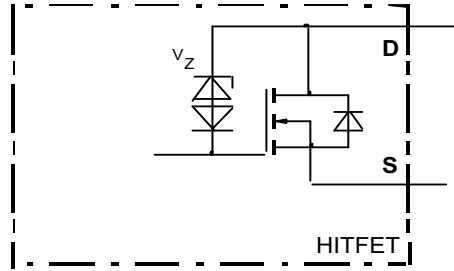

### Input circuit (ESD protection)

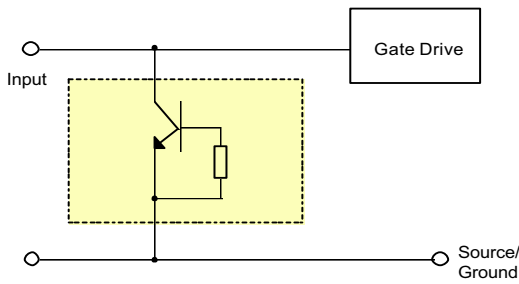

### Short circuit behaviour

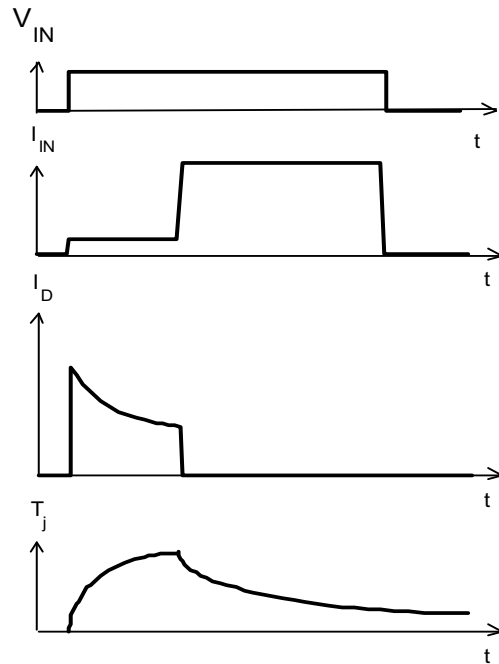

**1 Maximum allowable power dissipation**

$P_{tot} = f(T_C)$  resp.

$P_{tot} = f(T_A) @ R_{thJA}=55 \text{ K/W}$

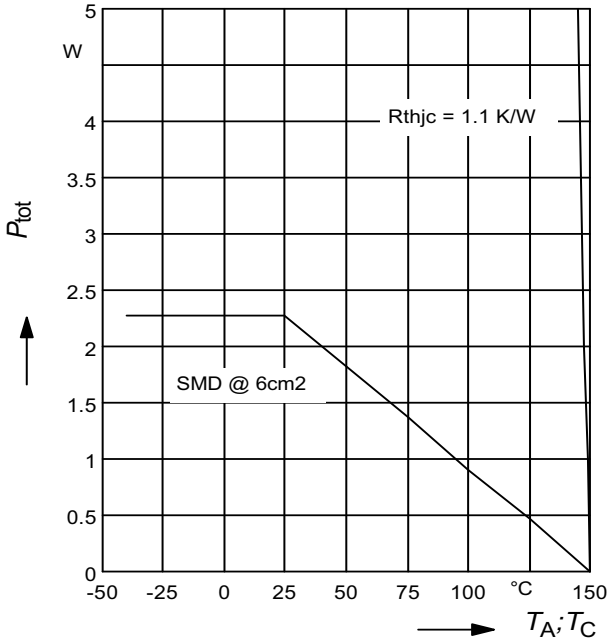

**2 On-state resistance**

$R_{ON} = f(T_j); I_D=12.6A; V_{IN}=10V$

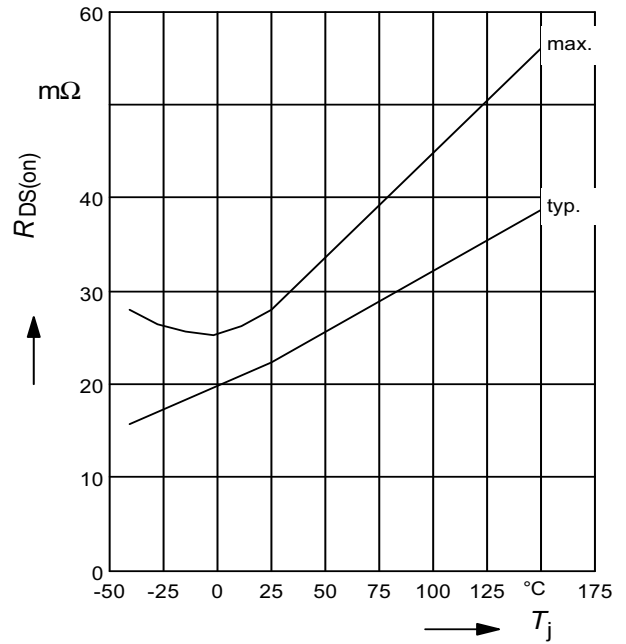

**3 On-state resistance**

$R_{ON} = f(T_j); I_D= 12.6A; V_{IN}=5V$

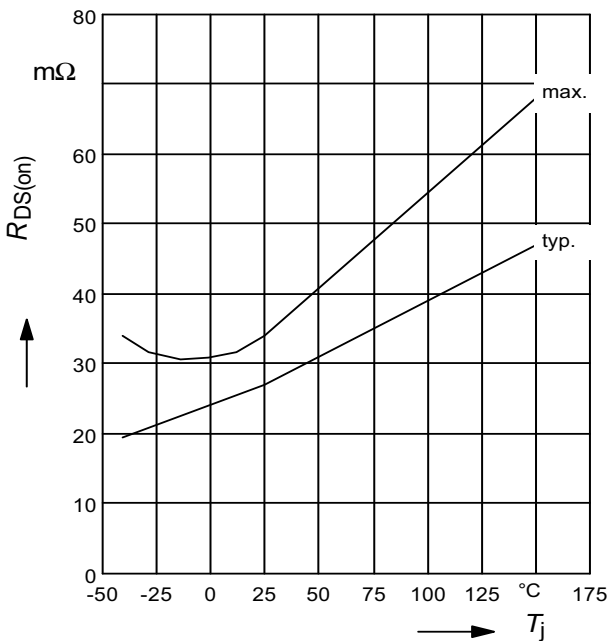

**4 Typ. input threshold voltage**

$V_{IN(th)} = f(T_j); I_D = 1.2 \text{ mA}; V_{DS} = 12V$

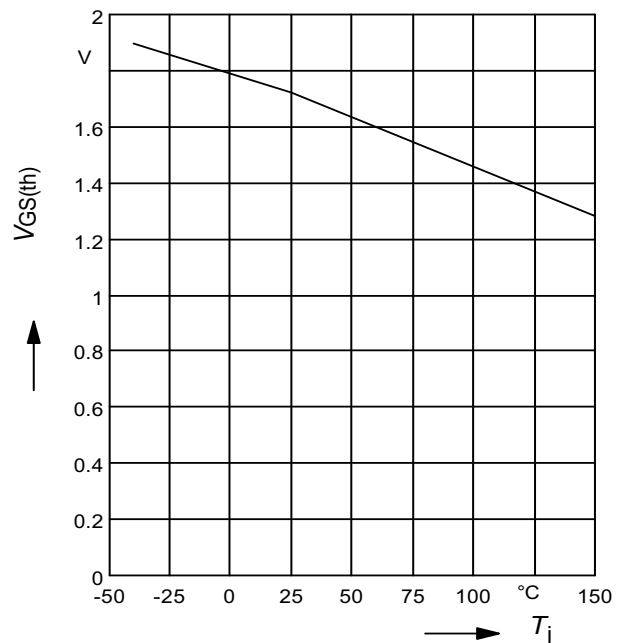

**5 Typ. transfer characteristics**

$I_D = f(V_{IN})$ ;  $V_{DS} = 12V$ ;  $T_{Jstart} = 25\text{ °C}$

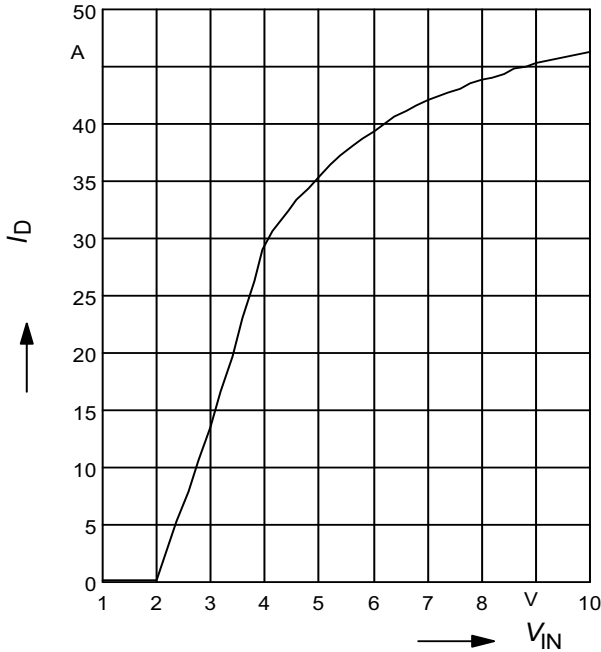

**6 Typ. short circuit current**

$I_{D(lim)} = f(T_j)$ ;  $V_{DS} = 12V$

Parameter:  $V_{IN}$

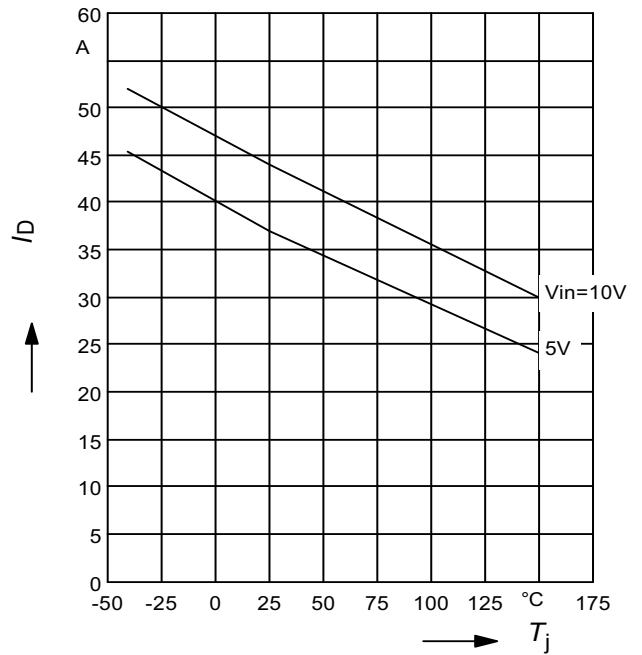

**7 Typ. output characteristics**

$I_D = f(V_{DS})$ ;  $T_{Jstart} = 25\text{ °C}$

Parameter:  $V_{IN}$

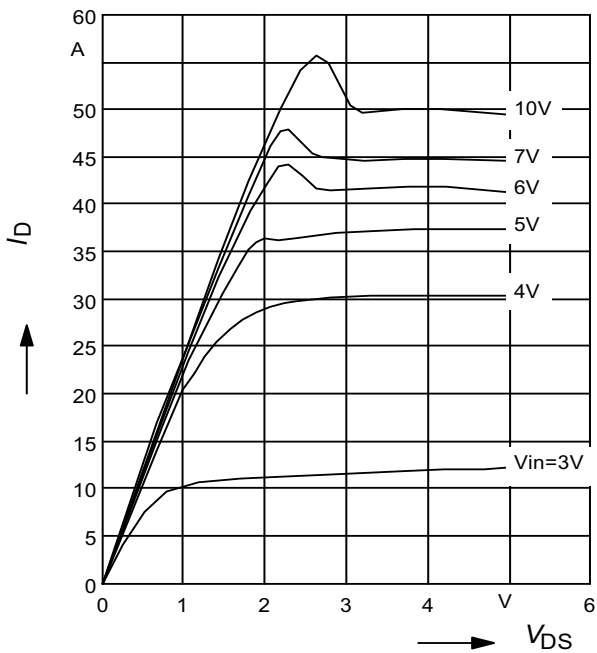

**8 Typ. off-state drain current**

$I_{DSS} = f(T_j)$

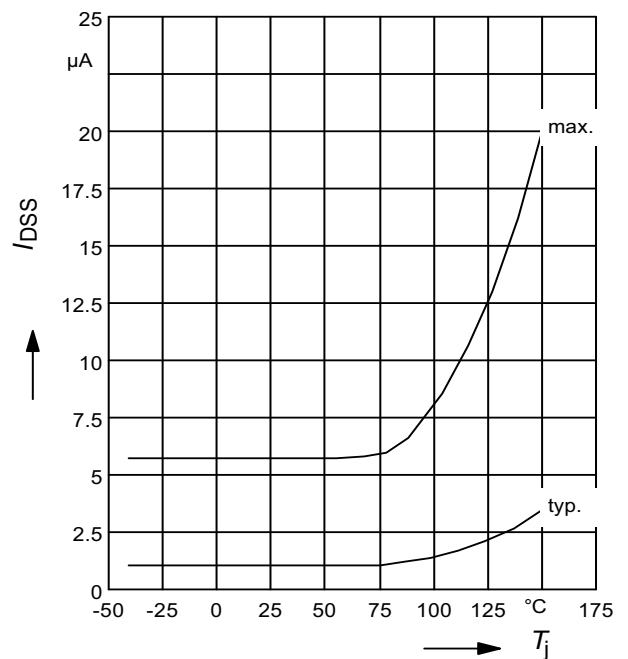

**9 Typ. overload current**

$I_{D(lim)} = f(t)$ ,  $V_{bb}=12\text{ V}$ , no heatsink

Parameter:  $T_{jstart}$

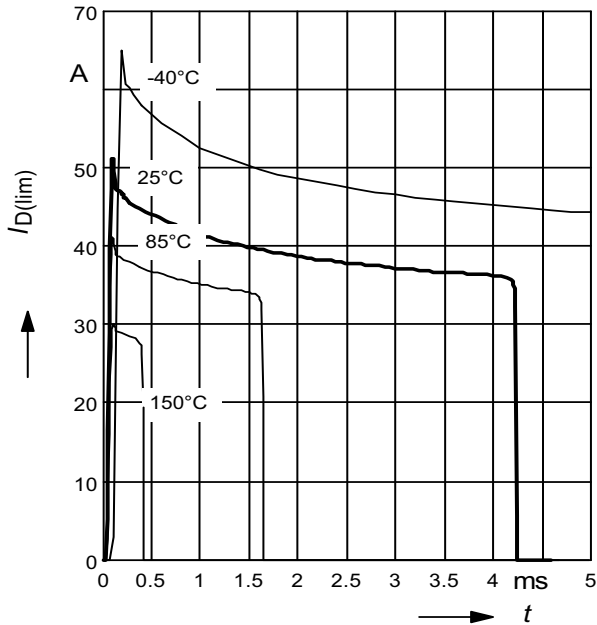

**10 Typ. transient thermal impedance**

$Z_{thJA} = f(t_p)$  @  $6\text{ cm}^2$  cooling area

Parameter:  $D = t_p / T$

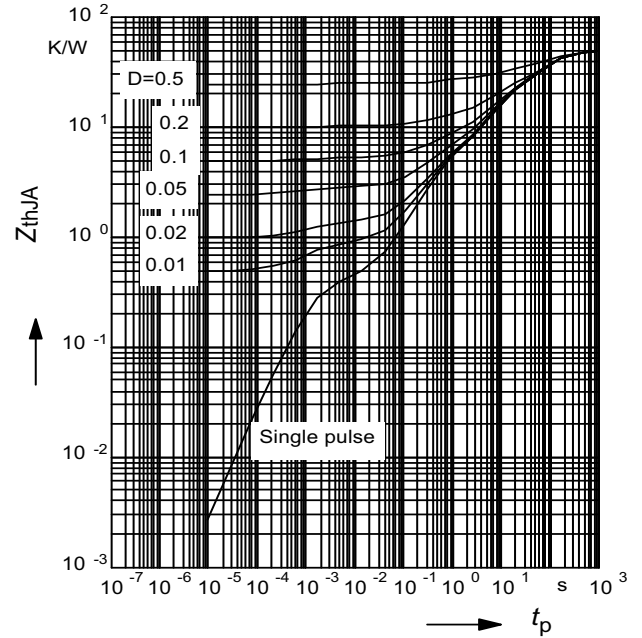

**11 Determination of  $I_{D(lim)}$**

$I_{D(lim)} = f(t)$ ;  $t_m = 200\mu\text{s}$

Parameter:  $T_{jstart}$

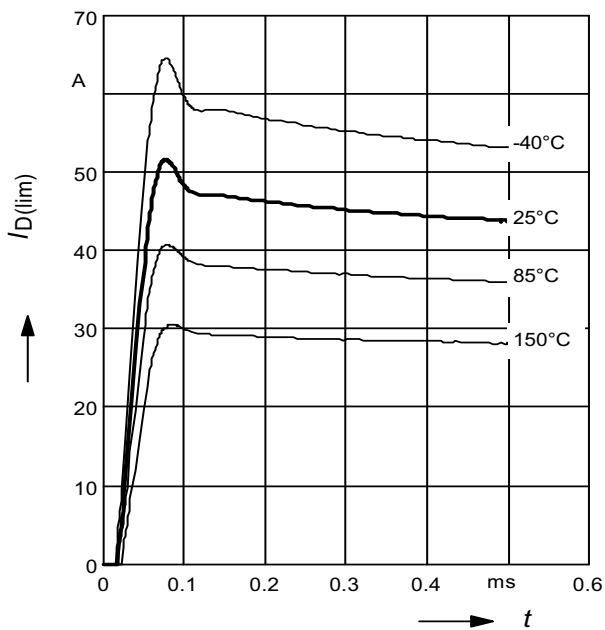



# 1 Package Outlines

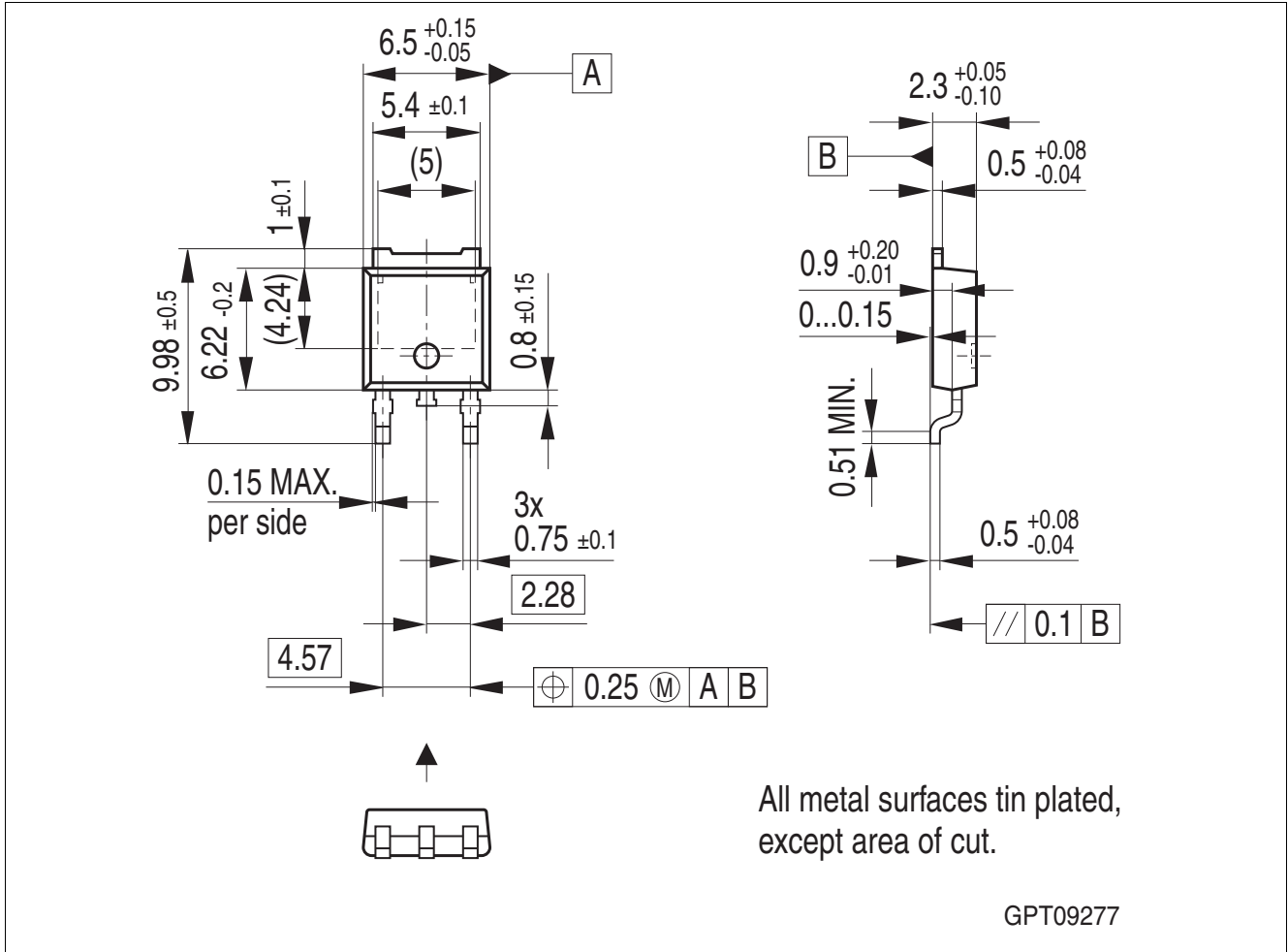

**Figure 1** PG-TO252-3-11 (Plastic Dual Small Outline Package) (RoHS-Compliant)

To meet the world-wide customer requirements for environmentally friendly products and to be compliant with government regulations the device is available as a green product. Green products are RoHS-Compliant (i.e Pb-free finish on leads and suitable for Pb-free soldering according to IPC/JEDEC J-STD-020).

Please specify the package needed (e.g. green package) when placing an order

## 2 Revision History

Version	Date	Changes
Rev. 1.4	2013-03-07	page 2: - added footnote "Not subject to production test, specified by design" for chapter/table Maximum Ratings - added footnote "Not subject to prod. test, calculated ..." for parameter $P_{tot}$ - updated ESD HBM standard in chapter "Maximum Ratings" page 3: - updated test condition $I_D$ for parameter input threshold voltage $V_{IN(th)}$ - added footnote "Not subject to production test, calculated..." to the parameter Nominal load current $I_{D(nom)}$ , $I_{D(ISO)}$
Rev. 1.3	2006-12-22	released automotive green and robust version (BTS) Package parameter (humidity and climatic) removed in Maximum ratings
Rev. 1.2	2006-12-11	AEC icon added RoHS icon added Green product (RoHS-compliant) added to the feature list Package information updated to green Green explanation added
Rev. 1.1	2006-08-08	released non automotive green version (ITS)
Rev. 1.0	2004-03-05	released production version

**Edition 2013-03-07**

**Published by  
Infineon Technologies AG  
81726 Munich, Germany**

**© Infineon Technologies AG 2013.  
All Rights Reserved.**

### **Legal Disclaimer**

The information given in this document shall in no event be regarded as a guarantee of conditions or characteristics ("Beschaffenhheitsgarantie"). With respect to any examples or hints given herein, any typical values stated herein and/or any information regarding the application of the device, Infineon Technologies hereby disclaims any and all warranties and liabilities of any kind, including without limitation warranties of non-infringement of intellectual property rights of any third party.

### **Information**

For further information on technology, delivery terms and conditions and prices please contact your nearest Infineon Technologies Office ([www.infineon.com](http://www.infineon.com)).

### **Warnings**

Due to technical requirements components may contain dangerous substances. For information on the types in question please contact your nearest Infineon Technologies Office.

Infineon Technologies Components may only be used in life-support devices or systems with the express written approval of Infineon Technologies, if a failure of such components can reasonably be expected to cause the failure of that life-support device or system, or to affect the safety or effectiveness of that device or system. Life support devices or systems are intended to be implanted in the human body, or to support and/or maintain and sustain and/or protect human life. If they fail, it is reasonable to assume that the health of the user or other persons may be endangered.

# Mouser Electronics

Authorized Distributor

Click to View Pricing, Inventory, Delivery & Lifecycle Information:

[Infineon:](#)

[BTS3142D](#) [BTS3142DATMA1](#)



Компания «ЭлектроПласт» предлагает заключение долгосрочных отношений при поставках импортных электронных компонентов на взаимовыгодных условиях!

Наши преимущества:

- Оперативные поставки широкого спектра электронных компонентов отечественного и импортного производства напрямую от производителей и с крупнейших мировых складов;
- Поставка более 17-ти миллионов наименований электронных компонентов;
- Поставка сложных, дефицитных, либо снятых с производства позиций;
- Оперативные сроки поставки под заказ (от 5 рабочих дней);
- Экспресс доставка в любую точку России;
- Техническая поддержка проекта, помощь в подборе аналогов, поставка прототипов;
- Система менеджмента качества сертифицирована по Международному стандарту ISO 9001;
- Лицензия ФСБ на осуществление работ с использованием сведений, составляющих государственную тайну;
- Поставка специализированных компонентов (Xilinx, Altera, Analog Devices, Intersil, Interpoint, Microsemi, Aeroflex, Peregrine, Syfer, Eurofarad, Texas Instrument, Miteq, Cobham, E2V, MA-COM, Hittite, Mini-Circuits, General Dynamics и др.);

Помимо этого, одним из направлений компании «ЭлектроПласт» является направление «Источники питания». Мы предлагаем Вам помощь Конструкторского отдела:

- Подбор оптимального решения, техническое обоснование при выборе компонента;
- Подбор аналогов;
- Консультации по применению компонента;
- Поставка образцов и прототипов;
- Техническая поддержка проекта;
- Защита от снятия компонента с производства.



#### Как с нами связаться

**Телефон:** 8 (812) 309 58 32 (многоканальный)

**Факс:** 8 (812) 320-02-42

**Электронная почта:** [org@eplast1.ru](mailto:org@eplast1.ru)

**Адрес:** 198099, г. Санкт-Петербург, ул. Калинина, дом 2, корпус 4, литера А.