

FEATURES

Ultralow power consumption with $I_{CC} = 92 \text{ nA}$ (typical)

Precision, low voltage monitoring

Pretrimmed voltage monitoring threshold options

10 options from 2 V to 4.63 V for the [ADM8641](#)

20 options from 0.5 V to 1.9 V for the [ADM8642](#)

$\pm 1.3\%$ threshold accuracy over full temperature range

Output disable input

23 μs to 26 μs typical propagation delay

Open-drain type output

Power supply glitch immunity

Available in a 1.46 mm \times 0.96 mm WLCSP

Operational temperature range: -40°C to $+85^\circ\text{C}$

APPLICATIONS

Portable/battery-operated equipment

Microprocessor systems

Energy metering

Energy harvesting

GENERAL DESCRIPTION

The [ADM8641](#) and [ADM8642](#) are simple voltage detectors suitable for use in general-purpose applications. The ultralow power consumption of these devices makes them suitable for power efficiency sensitive systems, such as battery-powered portable devices and energy meters.

The factory preset detection thresholds from 0.5 V to 4.63 V with $\pm 1.2\%$ accuracy over the full temperature range enable the devices to monitor the node of interest accurately with direct contact. The $\overline{\text{DIS}}$ input lets the user hold the output low regardless of the state of the input. Not all device options are

FUNCTIONAL BLOCK DIAGRAMS

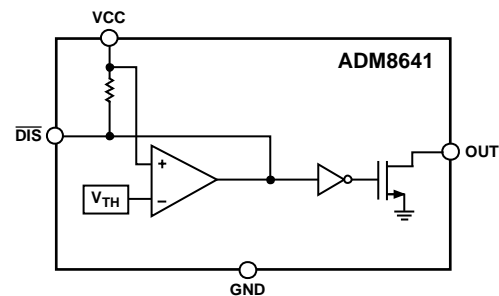

Figure 1. [ADM8641](#) Functional Block Diagram

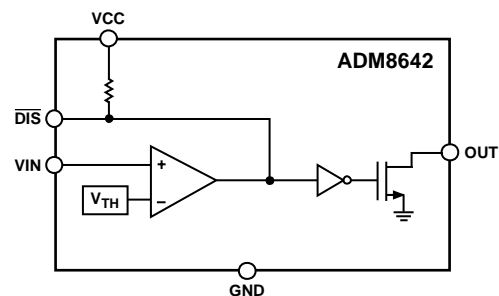

Figure 2. [ADM8642](#) Functional Block Diagram

released for sale as standard models. See the Ordering Guide section for full information.

The [ADM8641](#) monitors the voltage using the VCC pin. The separate supply pin on the [ADM8642](#) allows it to have a lower detection threshold down to 0.5 V.

The [ADM8641](#) and [ADM8642](#) are available in a 6-ball, 1.46 mm \times 0.96 mm WLCSP. These devices are specified over the -40°C to $+85^\circ\text{C}$ temperature range.

TABLE OF CONTENTS

Features	1	Typical Performance Characteristics	7
Applications.....	1	Theory of Operation	9
Functional Block Diagrams.....	1	Voltage Monitoring Input	9
General Description	1	VIN as an Adjustable Input.....	9
Revision History	2	Transient Immunity	9
Specifications.....	3	Output.....	9
Absolute Maximum Ratings.....	5	Disable Input.....	9
Thermal Resistance	5	Device Model Options	10
ESD Caution.....	5	Outline Dimensions	11
Pin Configurations and Function Descriptions	6	Ordering Guide	11

REVISION HISTORY

1/2018—Rev. B to Rev. C

Changes to General Description	1
Added Note 1 to Table 1	3
Changed Out Output Parameter, Table 1 to Out Pin Output Parameter, Table 1, DIS Input Parameter, Table 1 to DIS Pin Input Parameter, Table 1	4
Changed Device Options Section to Device Model Options Section.....	10
Changes to Device Model Options Section	10
Changes to Ordering Guide	11

1/2016—Rev. A to Rev. B

Changes to Ordering Guide	11
---------------------------------	----

4/2015—Rev. 0 to Rev. A

Changes to Threshold Hysteresis Parameter, Table 1	3
--	---

1/2015—Revision 0: Initial Version

SPECIFICATIONS

$V_{CC} = 2\text{ V to } 5.5\text{ V}$, $V_{IN} < V_{CC} + 0.3\text{ V}$, $T_A = -40^\circ\text{C to } +85^\circ\text{C}$, unless otherwise noted. Typical values are at $T_A = 25^\circ\text{C}$.

Table 1.

Parameter	Symbol	Min	Typ	Max	Unit	Test Conditions/Comments
OPERATING VOLTAGE RANGE	V_{CC}					
ADM8641		0.9		5.5	V	Guarantees valid OUT output
ADM8642		2		5.5	V	Guarantees valid OUT output
		0.9			V	Guarantees OUT low
UNDERVOLTAGE LOCKOUT						ADM8642 only
Input Voltage Rising	$UVLO_{RISE}$			1.95	V	
Input Voltage Falling	$UVLO_{FALL}$	1.6			V	
Hysteresis	$UVLO_{HYS}$		90		mV	
INPUT CURRENT						
VCC Quiescent Current	I_{CC}		92	190	nA	$V_{CC} = 2\text{ V to } 5.5\text{ V}$, OUT pulled high
				110	nA	$T_A = 25^\circ\text{C}$, OUT pulled high
VIN Average Input Current	I_{VIN}		4	32	nA	$V_{IN} = 2\text{ V}$, $V_{CC} = 2\text{ V}$
			4	8.5	nA	$V_{IN} = 2\text{ V}$, $V_{CC} = 5.5\text{ V}$
THRESHOLD VOLTAGE ¹	V_{TH}					Input falling
ADM8641		$V_{TH} - 1.3\%$	V_{TH}	$V_{TH} + 1.3\%$	V	See Table 6
ADM8642		$V_{TH} - 1.3\%$	V_{TH}	$V_{TH} + 1.3\%$	V	See Table 7, $V_{TH} \geq 1.2\text{ V}$
		$V_{TH} - 1.4\%$	1.1	$V_{TH} + 1.4\%$	V	1.1 V threshold option
		$V_{TH} - 1.6\%$	1	$V_{TH} + 1.6\%$	V	1 V threshold option
		$V_{TH} - 1.6\%$	0.95	$V_{TH} + 1.6\%$	V	0.95 V threshold option
		$V_{TH} - 1.7\%$	0.9	$V_{TH} + 1.7\%$	V	0.9 V threshold option
		$V_{TH} - 1.8\%$	0.85	$V_{TH} + 1.8\%$	V	0.85 V threshold option
		$V_{TH} - 1.8\%$	0.8	$V_{TH} + 1.8\%$	V	0.8 V threshold option
		$V_{TH} - 1.9\%$	0.75	$V_{TH} + 1.9\%$	V	0.75 V threshold option
		$V_{TH} - 1.9\%$	0.7	$V_{TH} + 1.9\%$	V	0.7 V threshold option
		$V_{TH} - 2.0\%$	0.65	$V_{TH} + 2.0\%$	V	0.65 V threshold option
		$V_{TH} - 2.1\%$	0.6	$V_{TH} + 2.1\%$	V	0.6 V threshold option
		$V_{TH} - 2.1\%$	0.55	$V_{TH} + 2.1\%$	V	0.55 V threshold option
		$V_{TH} - 2.2\%$	0.5	$V_{TH} + 2.2\%$	V	0.5 V threshold option
THRESHOLD HYSTERESIS	V_{HYST}					
ADM8641			$0.9\% \times V_{TH}$		V	
ADM8642			$0.9\% \times V_{TH}$		V	$V_{TH} > 1\text{ V}$
			10.3		mV	$V_{TH} \leq 1\text{ V}$
PROPAGATION DELAY						
ADM8641 VCC to OUT	t_{PD_VCC}	18	26	37	μs	V_{CC} falling with $V_{TH} \times 10\%$ overdrive
		20.5	36	57	μs	V_{CC} rising with $V_{TH} \times 10\%$ overdrive
ADM8642 VIN to OUT	t_{PD_VIN}	13.5	23	35	μs	V_{IN} falling with $V_{TH} \times 10\%$ overdrive
		22	39.5	61	μs	V_{IN} rising with $V_{TH} \times 10\%$ overdrive
INPUT GLITCH REJECTION						
ADM8641 VCC Glitch Rejection	t_{GR_VCC}		23		μs	V_{CC} falling with $V_{TH} \times 10\%$ overdrive
			35		μs	V_{CC} rising with $V_{TH} \times 10\%$ overdrive
ADM8642 VIN Glitch Rejection	t_{GR_VIN}		21		μs	V_{IN} falling with $V_{TH} \times 10\%$ overdrive
			38		μs	V_{IN} rising with $V_{TH} \times 10\%$ overdrive

Parameter	Symbol	Min	Typ	Max	Unit	Test Conditions/Comments
OUT PIN OUTPUT						
Output Voltage Low	V_{OUT_OL}			0.4	V	$V_{CC} > 4.25\text{ V}$, $I_{SINK} = 6.5\text{ mA}$
				0.4	V	$V_{CC} > 2.5\text{ V}$, $I_{SINK} = 6\text{ mA}$
				0.4	V	$V_{CC} > 1.2\text{ V}$, $I_{SINK} = 4.6\text{ mA}$
				0.4	V	$V_{CC} > 0.9\text{ V}$, $I_{SINK} = 0.9\text{ mA}$
Leakage Current				5	nA	$V_{OUT} = V_{CC} = 5.5\text{ V}$
DIS PIN INPUT						
V_{IL}				0.4	V	
V_{IH}		0.9			V	
\overline{DIS} Glitch Rejection			0.4		μs	
\overline{DIS} to OUT Delay	t_{D_DIS1}		0.65		μs	\overline{DIS} falling
\overline{DIS} Pull-Up Resistance		0.5	0.6	0.82	$M\Omega$	

¹Not all device options are released for sale as standard models. See the Ordering Guide section for full information.

ABSOLUTE MAXIMUM RATINGS

Table 2.

Parameter	Rating
VCC	-0.3 V to +6 V
OUT	-0.3 V to +6 V
VIN	-0.3 V to +6 V
DIS	-0.3 V to $V_{CC} + 0.3 V$
Input/Output Current	10 mA
Storage Temperature Range	-40°C to +150°C
Operating Temperature Range	-40°C to +85°C

Stresses at or above those listed under Absolute Maximum Ratings may cause permanent damage to the product. This is a stress rating only; functional operation of the product at these or any other conditions above those indicated in the operational section of this specification is not implied. Operation beyond the maximum operating conditions for extended periods may affect product reliability.

THERMAL RESISTANCE

θ_{JA} is specified for a device soldered on an FR4 board with a minimum footprint.

Table 3.

Package Type	θ_{JA}	Unit
6-Ball WLCSP	105.6	°C/W

ESD CAUTION



ESD (electrostatic discharge) sensitive device. Charged devices and circuit boards can discharge without detection. Although this product features patented or proprietary protection circuitry, damage may occur on devices subjected to high energy ESD. Therefore, proper ESD precautions should be taken to avoid performance degradation or loss of functionality.

PIN CONFIGURATIONS AND FUNCTION DESCRIPTIONS

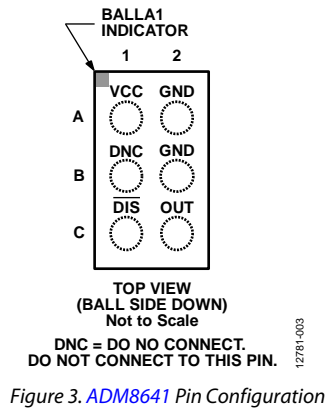

Figure 3. ADM8641 Pin Configuration

Table 4. ADM8641 Pin Function Descriptions

Pin No.	Mnemonic	Description
A1	VCC	Power Supply Input. The voltage on the VCC pin is monitored on the ADM8641. It is recommended to place a 0.1 μ F decoupling capacitor between the VCC pin and the GND pin.
A2	GND	Ground. Both GND pins on the ADM8641 must be grounded.
B1	DNC	Do Not Connect. Do not connect to this pin.
B2	GND	Ground. Both GND pins on the ADM8641 must be grounded.
C1	$\overline{\text{DIS}}$	Active Low Output Disable Input.
C2	OUT	Open-Drain Detector Output.

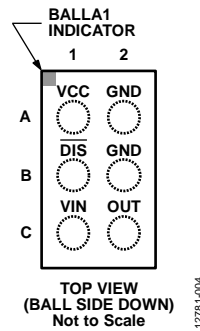

Figure 4. ADM8642 Pin Configuration

Table 5. ADM8642 Pin Function Descriptions

Pin No.	Mnemonic	Description
A1	VCC	Power Supply Input. The voltage on the VCC pin is not monitored on the ADM8642. It is recommended to place a 0.1 μ F decoupling capacitor between the VCC pin and the GND pin.
A2	GND	Ground. Both GND pins on the ADM8642 must be grounded.
B1	$\overline{\text{DIS}}$	Active Low Output Disable Input.
B2	GND	Ground. Both GND pins on the ADM8642 must be grounded.
C1	VIN	Low Voltage Monitoring Input. This separate supply input allows the ADM8642 to monitor low voltages of 0.8 V on the VIN pin.
C2	OUT	Open-Drain Detector Output.

TYPICAL PERFORMANCE CHARACTERISTICS

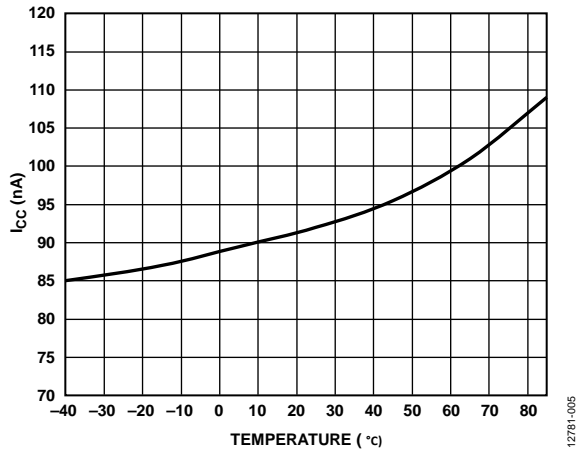

Figure 5. Supply Current (I_{CC}) vs. Temperature

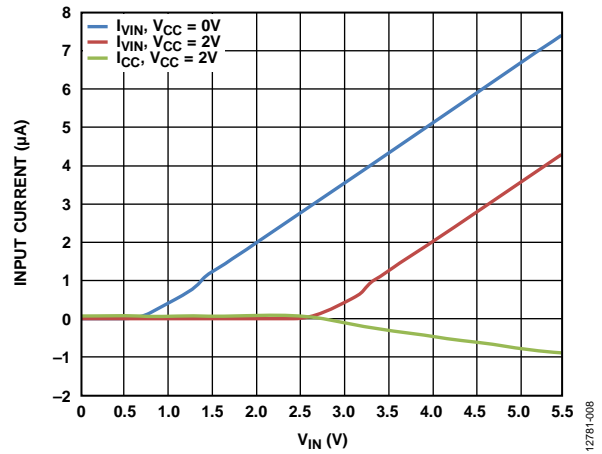

Figure 8. VIN Pin and VCC Pin Input Current vs. V_{IN}

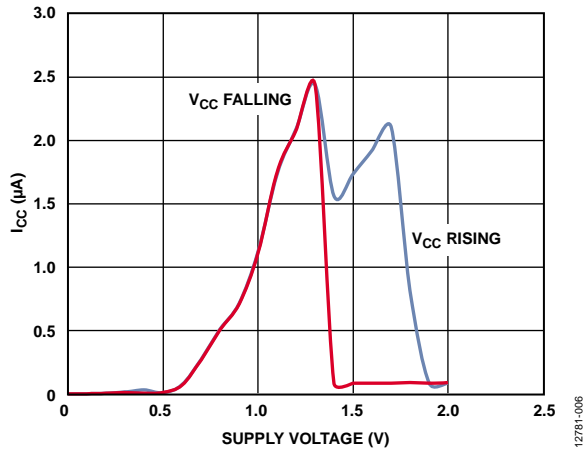

Figure 6. Supply Current (I_{CC}) vs. Supply Voltage, $V_{CC} < 2 V$

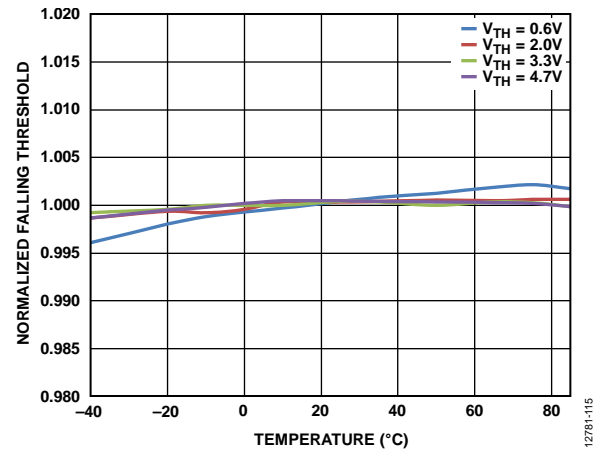

Figure 9. Normalized Falling Threshold vs. Temperature

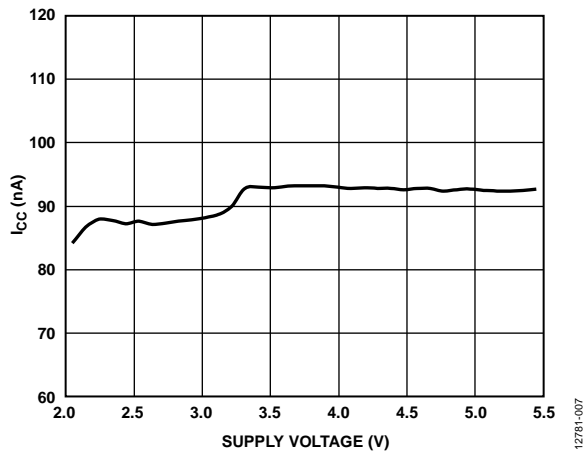

Figure 7. Supply Current (I_{CC}) vs. Supply Voltage

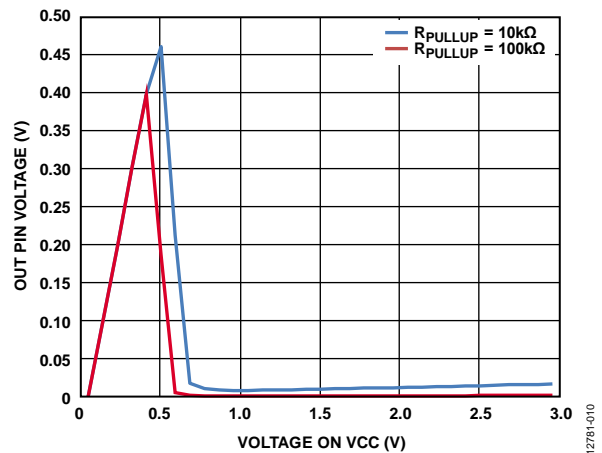

Figure 10. OUT Pin Voltage vs. Voltage on VCC (with the OUT Pin Pulled up to the VCC Pin Through R_{PULLUP})

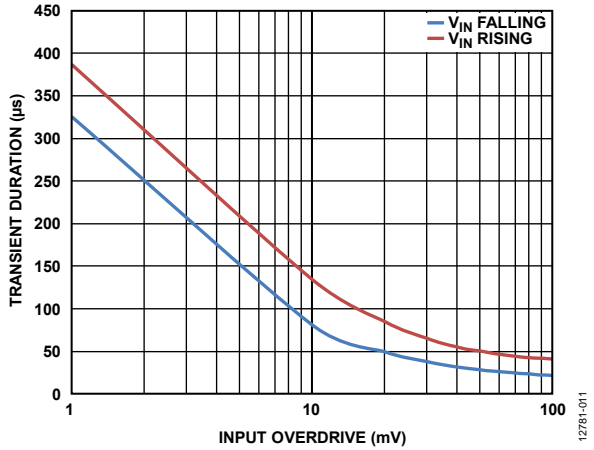

Figure 11. Maximum Transient Duration vs. Input Overdrive

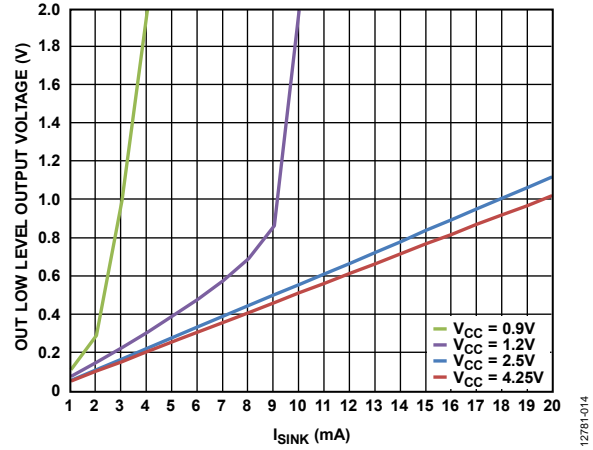

Figure 14. OUT Low Level Output Voltage vs. Sink Current (I_{SINK})

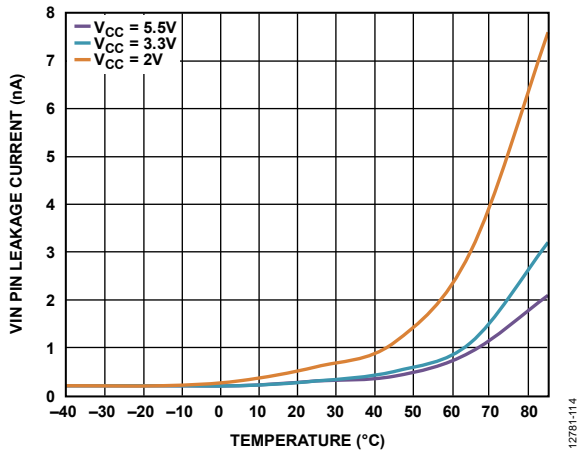

Figure 12. VIN Pin Leakage Current vs. Temperature

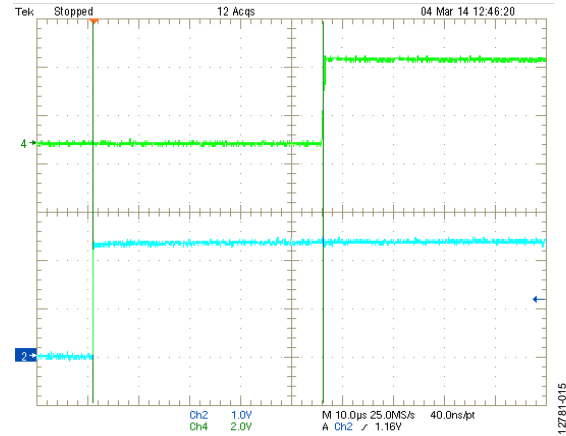

Figure 15. OUT Propagation Delay With VCC/VIN Rising

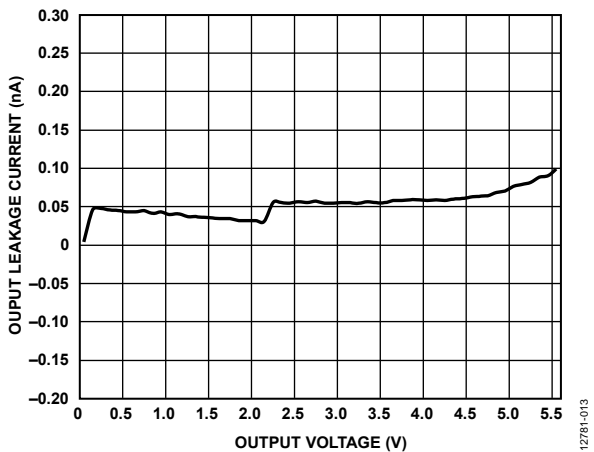

Figure 13. Output Leakage Current vs. Output Voltage

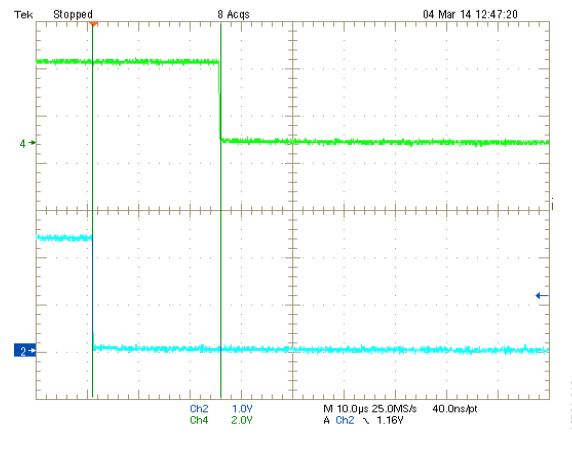

Figure 16. OUT Propagation Delay With VCC/VIN Falling

THEORY OF OPERATION

The [ADM8641](#) and [ADM8642](#) ultralow power voltage detectors are especially suited for battery-powered applications due to the 190 nA quiescent current (maximum). The internal precision reference allows the user to monitor specific voltage levels accurately from 0.5 V to 4.63 V. These devices feature internal input hysteresis and an open-drain output. The output remains logic high after the monitored input is above the preset threshold. The output changes to logic low after the input voltage falls below the threshold. The devices keep the output in a logic low state whenever the supply voltage on the VCC pin is below the UVLO threshold. The output disable input can also keep the output low regardless of the status on the input.

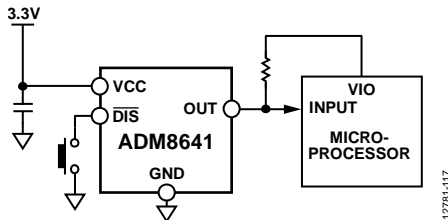

Figure 17. [ADM8641](#) Typical Application Circuit

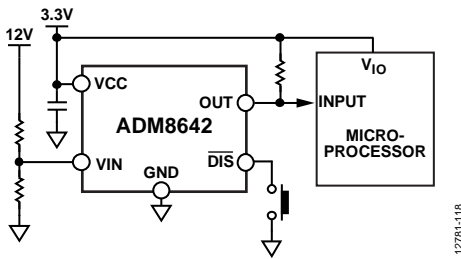

Figure 18. [ADM8642](#) Typical Application Circuit

VOLTAGE MONITORING INPUT

The VCC pin on the [ADM8641](#) acts as both a device power input node and a voltage monitoring input node. The [ADM8642](#) uses separate pins for supply and voltage monitoring to achieve a low voltage monitoring threshold to 0.5 V. It is recommended to place a 0.1 μ F decoupling capacitor between the VCC pin and the GND pin.

VIN AS AN ADJUSTABLE INPUT

Due to the low leakage nature of the VIN pin, the [ADM8642](#) can be used as a device with an adjustable threshold. Use an external resistor divider circuit to program the desired voltage monitoring threshold based on the VIN threshold, as shown in Figure 19.

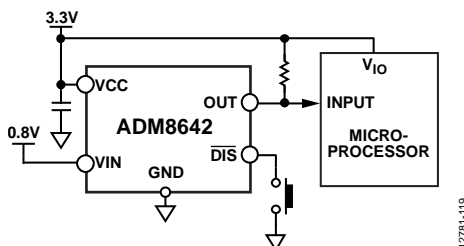

Figure 19. [ADM8642](#) as an Adjustable Threshold Device

TRANSIENT IMMUNITY

To avoid unnecessary output state changes caused by fast power supply transients, an input glitch filter is added to the VCC pin of the [ADM8641](#) and the VIN pin of the [ADM8642](#) to filter out the transient glitches on these pins.

Figure 11 shows the comparator overdrive (that is, the maximum magnitude of positive and negative going pulses with respect to the typical threshold) vs. the pulse duration without changing the state of the output.

OUTPUT

Both the [ADM8641](#) and [ADM8642](#) voltage detectors have an open-drain output. For the [ADM8641](#), the state of the output is guaranteed to be valid as soon as VCC rises above 0.9 V. For the [ADM8642](#), the output is guaranteed to be logic low from when VCC = 0.9 V to when the device exits ULVO.

When the monitored voltage falls below its associated threshold, the OUT pin asserts low after 23 μ s to 26 μ s (typical). When the monitored voltage rises above the threshold plus hysteresis, the OUT pin asserts high after 36 μ s to 39.5 μ s (typical).

DISABLE INPUT

The [ADM8641/ADM8642](#) feature a disable input ($\overline{\text{DIS}}$). Drive the $\overline{\text{DIS}}$ pin low to assert the output low. The $\overline{\text{DIS}}$ input has a 0.6 M Ω internal pull-up resistor so that the input is always high when unconnected. To drive the $\overline{\text{DIS}}$ input, use an external signal or a push-button switch to ground; debounce circuitry is integrated on-chip for this purpose. Noise immunity is provided on the $\overline{\text{DIS}}$ input, and fast, negative going transients of up to 0.4 μ s (typical) are ignored. If required, a 0.1 μ F capacitor between the DIS pin and ground provides additional noise immunity.

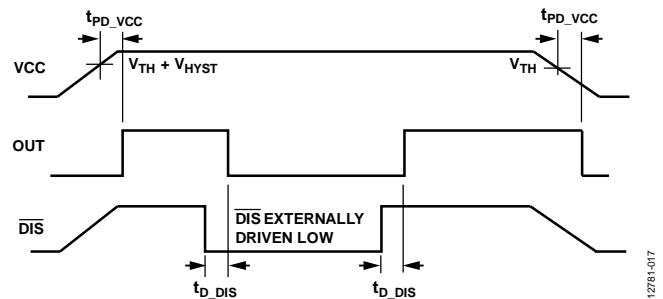

Figure 20. $\overline{\text{DIS}}$ Input Timing

DEVICE MODEL OPTIONS

The ADM8641/ADM8642 include many device options, however, not all options are released for sale. Released options are called standard models and are listed in the Ordering Guide section. The [Simple Reset Supervisory IC](#) page also offers a list

of standard models. Contact a sales representative for information on nonstandard models and be aware that samples and production units have long lead times.

Table 6. ADM8641 V_{CC} Threshold (V_{TH}) Options (T_A = -40°C to +85°C)

Threshold Number	Min	Typ	Max	Unit
200	1.974	2	2.026	V
220	2.171	2.2	2.229	V
232	2.290	2.32	2.350	V
263	2.596	2.63	2.664	V
280	2.764	2.8	2.836	V
293	2.892	2.93	2.968	V
300	2.961	3	3.039	V
308	3.040	3.08	3.120	V
440	4.343	4.4	4.457	V
463	4.570	4.63	4.690	V

Table 7. ADM8642 V_{IN} Threshold (V_{TH}) Options (T_A = -40°C to +85°C)

Threshold Number	Min	Typ	Max	Unit
050	0.489	0.5	0.511	V
055	0.538	0.55	0.562	V
060	0.588	0.6	0.612	V
065	0.637	0.65	0.663	V
070	0.686	0.7	0.714	V
075	0.736	0.75	0.764	V
080	0.785	0.8	0.815	V
085	0.835	0.85	0.865	V
090	0.885	0.9	0.915	V
095	0.935	0.95	0.965	V
100	0.984	1	1.016	V
110	1.084	1.1	1.116	V
120	1.184	1.2	1.216	V
130	1.283	1.3	1.317	V
140	1.382	1.4	1.418	V
150	1.481	1.5	1.520	V
160	1.579	1.6	1.621	V
170	1.678	1.7	1.722	V
180	1.777	1.8	1.823	V
190	1.875	1.9	1.925	V

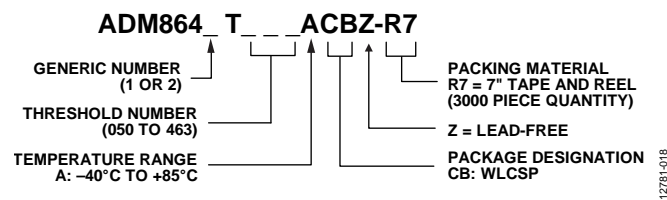

Figure 21. Ordering Code Structure

OUTLINE DIMENSIONS

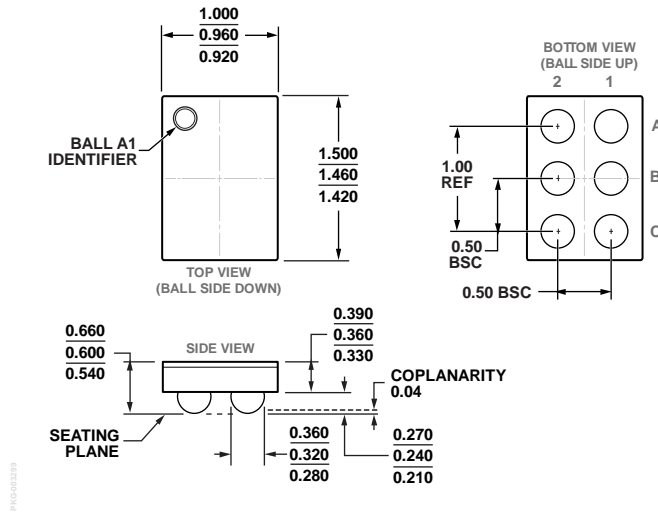

Figure 22. 6-Ball Wafer Level Chip Scale Package [WLCSP] (CB-6-17)
 Dimensions shown in millimeters

ORDERING GUIDE

Model ^{1, 2, 3}	Temperature Range	Threshold Voltage (V)	Package Description	Package Option	Marking Code
ADM8641T263ACBZ-R7	-40°C to +85°C	2.63	6-Ball WLCSP	CB-6-17	DT
ADM8642T100ACBZ-R7	-40°C to +85°C	1.0	6-Ball WLCSP	CB-6-17	DU
ADM8641-EVALZ			Evaluation Board		
ADM8642-EVALZ			Evaluation Board		

¹ Z = RoHS Compliant Part.

² ADM8641/ADM8642 include many device options, however, not all options are released for sale. Released options are called standard models and are listed in the Ordering Guide. The Simple Reset Supervisory IC page also offers a list of standard models. Contact a sales representative for information on nonstandard models and be aware that samples and production units have long lead times.

³ If ordering nonstandard models, complete the ordering code shown in Figure 21 by inserting the model number and threshold number.



Компания «ЭлектроПласт» предлагает заключение долгосрочных отношений при поставках импортных электронных компонентов на взаимовыгодных условиях!

Наши преимущества:

- Оперативные поставки широкого спектра электронных компонентов отечественного и импортного производства напрямую от производителей и с крупнейших мировых складов;
- Поставка более 17-ти миллионов наименований электронных компонентов;
- Поставка сложных, дефицитных, либо снятых с производства позиций;
- Оперативные сроки поставки под заказ (от 5 рабочих дней);
- Экспресс доставка в любую точку России;
- Техническая поддержка проекта, помощь в подборе аналогов, поставка прототипов;
- Система менеджмента качества сертифицирована по Международному стандарту ISO 9001;
- Лицензия ФСБ на осуществление работ с использованием сведений, составляющих государственную тайну;
- Поставка специализированных компонентов (Xilinx, Altera, Analog Devices, Intersil, Interpoint, Microsemi, Aeroflex, Peregrine, Syfer, Eurofarad, Texas Instrument, Miteq, Cobham, E2V, MA-COM, Hittite, Mini-Circuits, General Dynamics и др.);

Помимо этого, одним из направлений компании «ЭлектроПласт» является направление «Источники питания». Мы предлагаем Вам помощь Конструкторского отдела:

- Подбор оптимального решения, техническое обоснование при выборе компонента;
- Подбор аналогов;
- Консультации по применению компонента;
- Поставка образцов и прототипов;
- Техническая поддержка проекта;
- Защита от снятия компонента с производства.



Как с нами связаться

Телефон: 8 (812) 309 58 32 (многоканальный)

Факс: 8 (812) 320-02-42

Электронная почта: org@eplast1.ru

Адрес: 198099, г. Санкт-Петербург, ул. Калинина, дом 2, корпус 4, литера А.