

**NEW**

# ATP19 Series Anti-Vandal Sealed Pushbutton Switch



**A**  
Pushbutton

## Features/Benefits

- Momentary or Lock version
- IP67 sealed & IK10 (Stainless steel bushing)
- Capable of up to 3A resistive load
- 50,000 life cycle at full load
- Various colors of LED illuminate indicator
- Choices of pushbutton with symbol on spot, ring or power logo

## Typical Applications

- Control Panels including car park and traffic light
- Industrial Instruments
- Lifts / Escalator
- Communication equipment
- Alarm, safety and security systems



**C&K** US

## Specifications

FUNCTION: Single pole and double poles  
CONTACT ARRANGEMENT: N.O. and N.C.  
MOUNTING TYPE: Threaded front panel mount  
TORQUE FOR THREADED BODY: 5-14 Nm

## Mechanical

OPERATING LIFE: Momentary 1,000,000 cycles  
Self-lock 500,000 cycles  
TOTAL TRAVEL: about 3.2 mm  
OPERATING FORCE: 1 pole 2.5 ± 1N  
2 pole 3.5 ± 1N

## Electrical

CONTACT RATING: 1th 5A/250VAC  
3A / 250VAC  
3A / 28VDC  
OPERATING LIFE: 50,000 make-and-break cycles at full load  
DIELECTRIC STRENGTH: 2,000 V RMS @ sea level  
INSULATION RESISTANCE: 1,000 MΩ min. @ 500 VDC  
INITIAL CONTACT RESISTANCE : 50 mΩ max @1A 12VDC

## Materials

BUSHING: Stainless steel / Nickel plated brass / Aluminum alloy  
BASE: PBT (UL 94-A0), PC (UL 94-V2)  
ACTUATOR: PC (UL 94-V2); Stainless steel / Nickel plated brass / Aluminum alloy  
INTERNAL ASSEMBLY: POM / PA66  
SPRING: Steel  
SEALING / O-ring: Silicone  
TERMINALS: Brass with silver or gold plated  
CONTACT: Copper, silver plated

## Operating Environment

OPERATING TEMPERATURE: -20°C to +55°C  
SEALING / PROTECTION: IP67 / IK10 (Stainless steel bushing)

**NOTE:** Specifications and materials listed above are for switches with standard options.  
For information on specific and custom switches, please contact Customer Service.

## Build-A-Switch

To order, simply select desired option from each category and place in the appropriate box.



**Designation** \_\_\_\_\_  
**ATP19** Series

**Actuator Style**

- S** Standard
- R** Raised
- D** Dome without LED only

**Actuator Indicator**

- L0** Without LED
- L1** Fix ring
- L2** Spot
- L3** Moving ring (standard actuator only)
- L4** Power logo\*
- L5** Moving ring & Power logo\* (standard actuator only)

**LED Illumination**

Color	Dual color
<b>0</b> Without LED	<b>A</b> Red & Green
<b>2</b> White	<b>B</b> Red & Blue
<b>3</b> Red	<b>D</b> Blue & Yellow
<b>5</b> Yellow	<b>G</b> Red & Yellow
<b>6</b> Green	<b>H</b> Green & Yellow
<b>7</b> Blue	<b>J</b> Orange & Green

**LED voltage (20mA)**

- 00** Without LED
- 03** 3V
- 06** 6V
- 12** 12V
- 24** 24V
- 36** 36V
- A1** 110V AC
- A2** 220V AC

**Terminal plating**

- Q** Silver
- G** Gold

**Termination**

- 03** STD solder lug
- 04** Short solder lug
- W1** Wire lead 500mm \*\*
- W2** Wire lead 1,000mm \*\*

**Mechanical function**

- A** Momentary
- E** Lock

**Contact arrangement**

- S** SPDT
- D** DPDT

**Bushing type**

Round	Double D shape
<b>B0</b> Stainless (Natural)	<b>M0</b> Stainless (Natural)
<b>B1</b> Brass (Mirror Chrome Plated)	<b>M1</b> Brass (Mirror Chrome plated)
<b>B2</b> Brass (Nickel plated)	<b>M2</b> Brass (Nickel plated)
<b>B3</b> Al alloy (Black anodized)	<b>M3</b> Al alloy (Black anodized)

\* Available on double D-shape bushing only.  
\*\* Available upon request, please contact your sales representative for details.

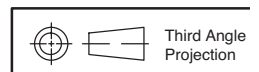

Dimensions are shown: mm (inches)  
Specifications and dimensions subject to change



11 Apr 19



# ATP19 Series Anti-Vandal Sealed Pushbutton Switch

**NEW**

Pushbutton  
A

## STANDARD VIEW

**ROUND BUSHING**

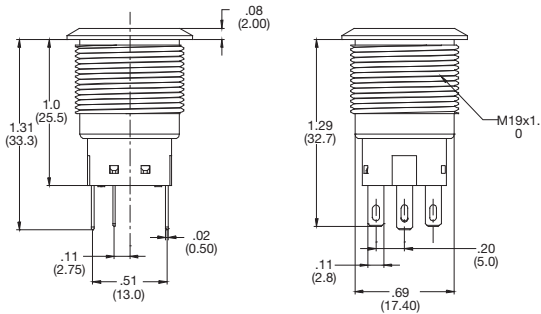

**DOUBLE-D BUSHING**

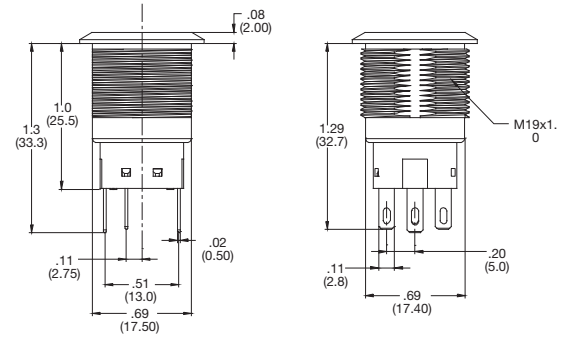

## ACTUATOR STYLE

**S STANDARD**

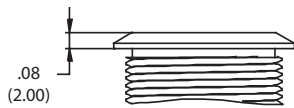

**R RAISED**

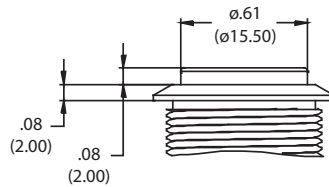

**D DOME**

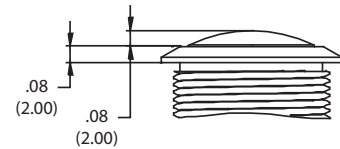

## ACTUATOR INDICATOR

**L0 WITHOUT LED**

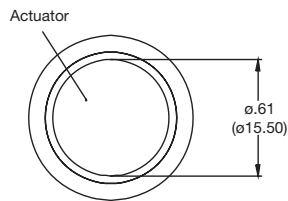

**L1 FIX RING**

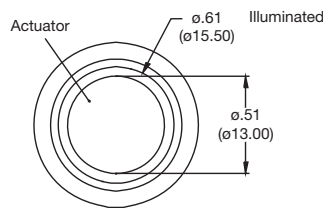

**L3 MOVING RING**

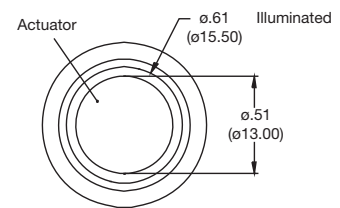

**L2 SPOT**

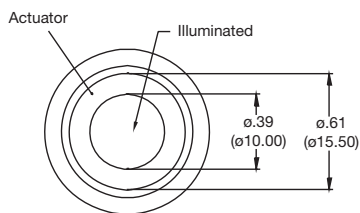

**L4 POWER LOGO**

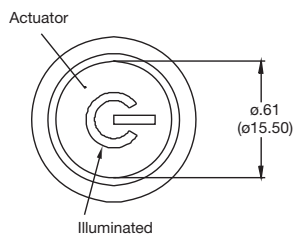

**L5 POWER & MOVING RING**

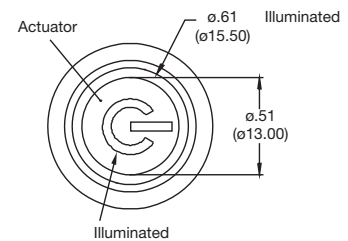

**NEW**

# ATP19 Series Anti-Vandal Sealed Pushbutton Switch



**A**

**Pushbutton**

## CIRCUIT

**SPDT**

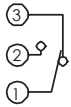

**SPDT - SINGLE COLOR LED**

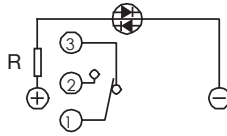

**SPDT - DUAL COLOR LED**

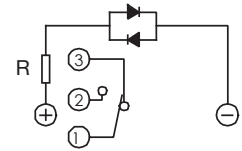

**DPDT**

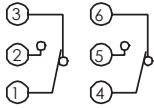

**DPDT - SINGLE COLOR LED**

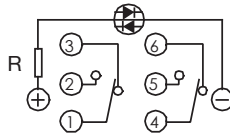

**DPDT - DUAL COLOR LED**

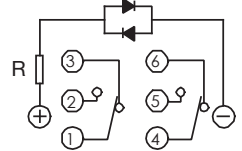

## TERMINATION

**03 SOLDERLUG**

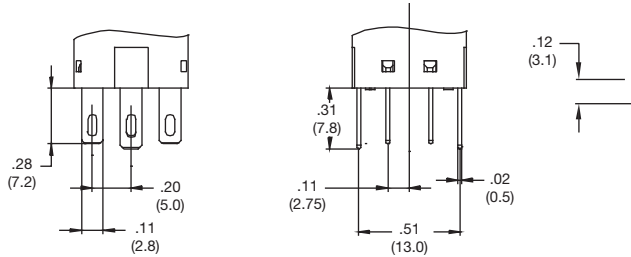

**04 SHORT SOLDER LUG**

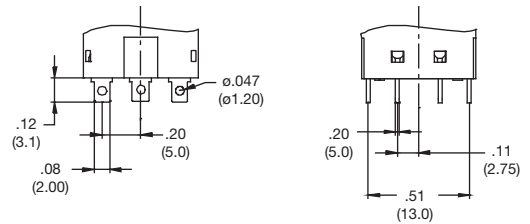

**W1 OR W2 WIRE LEAD**

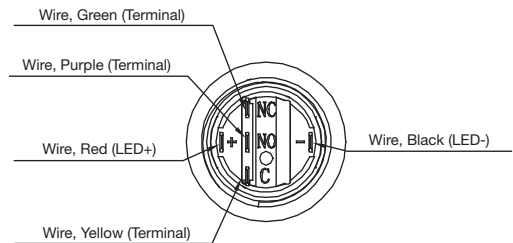
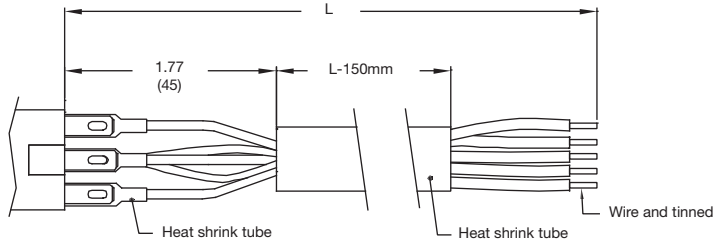

## HARDWARE

**HEX NUT**

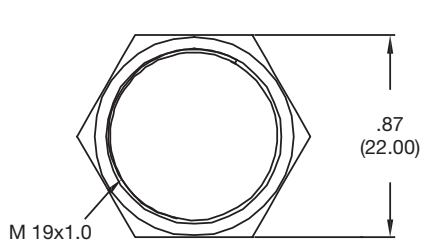

**O - RING**

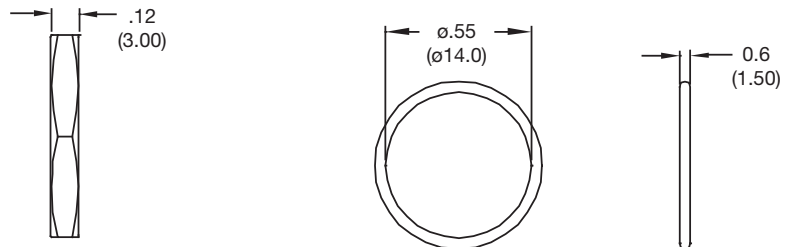



Компания «ЭлектроПласт» предлагает заключение долгосрочных отношений при поставках импортных электронных компонентов на взаимовыгодных условиях!

Наши преимущества:

- Оперативные поставки широкого спектра электронных компонентов отечественного и импортного производства напрямую от производителей и с крупнейших мировых складов;
- Поставка более 17-ти миллионов наименований электронных компонентов;
- Поставка сложных, дефицитных, либо снятых с производства позиций;
- Оперативные сроки поставки под заказ (от 5 рабочих дней);
- Экспресс доставка в любую точку России;
- Техническая поддержка проекта, помощь в подборе аналогов, поставка прототипов;
- Система менеджмента качества сертифицирована по Международному стандарту ISO 9001;
- Лицензия ФСБ на осуществление работ с использованием сведений, составляющих государственную тайну;
- Поставка специализированных компонентов (Xilinx, Altera, Analog Devices, Intersil, Interpoint, Microsemi, Aeroflex, Peregrine, Syfer, Eurofarad, Texas Instrument, Miteq, Cobham, E2V, MA-COM, Hittite, Mini-Circuits, General Dynamics и др.);

Помимо этого, одним из направлений компании «ЭлектроПласт» является направление «Источники питания». Мы предлагаем Вам помощь Конструкторского отдела:

- Подбор оптимального решения, техническое обоснование при выборе компонента;
- Подбор аналогов;
- Консультации по применению компонента;
- Поставка образцов и прототипов;
- Техническая поддержка проекта;
- Защита от снятия компонента с производства.



#### Как с нами связаться

**Телефон:** 8 (812) 309 58 32 (многоканальный)

**Факс:** 8 (812) 320-02-42

**Электронная почта:** [org@eplast1.ru](mailto:org@eplast1.ru)

**Адрес:** 198099, г. Санкт-Петербург, ул. Калинина, дом 2, корпус 4, литера А.