

NEW

ATP19 Series Anti-Vandal Sealed Pushbutton Switch



A
Pushbutton

Features/Benefits

- Momentary or Lock version
- IP67 sealed & IK10 (Stainless steel bushing)
- Capable of up to 3A resistive load
- 50,000 life cycle at full load
- Various colors of LED illuminate indicator
- Choices of pushbutton with symbol on spot, ring or power logo

Typical Applications

- Control Panels including car park and traffic light
- Industrial Instruments
- Lifts / Escalator
- Communication equipment
- Alarm, safety and security systems



C&K US

Specifications

FUNCTION: Single pole and double poles
CONTACT ARRANGEMENT: N.O. and N.C.
MOUNTING TYPE: Threaded front panel mount
TORQUE FOR THREADED BODY: 5-14 Nm

Mechanical

OPERATING LIFE: Momentary 1,000,000 cycles
Self-lock 500,000 cycles
TOTAL TRAVEL: about 3.2 mm
OPERATING FORCE: 1 pole 2.5 ± 1N
2 pole 3.5 ± 1N

Electrical

CONTACT RATING: 1th 5A/250VAC
3A / 250VAC
3A / 28VDC
OPERATING LIFE: 50,000 make-and-break cycles at full load
DIELECTRIC STRENGTH: 2,000 V RMS @ sea level
INSULATION RESISTANCE: 1,000 MΩ min. @ 500 VDC
INITIAL CONTACT RESISTANCE : 50 mΩ max @1A 12VDC

Materials

BUSHING: Stainless steel / Nickel plated brass / Aluminum alloy
BASE: PBT (UL 94-A0), PC (UL 94-V2)
ACTUATOR: PC (UL 94-V2); Stainless steel / Nickel plated brass / Aluminum alloy
INTERNAL ASSEMBLY: POM / PA66
SPRING: Steel
SEALING / O-ring: Silicone
TERMINALS: Brass with silver or gold plated
CONTACT: Copper, silver plated

Operating Environment

OPERATING TEMPERATURE: -20°C to +55°C
SEALING / PROTECTION: IP67 / IK10 (Stainless steel bushing)

NOTE: Specifications and materials listed above are for switches with standard options.
For information on specific and custom switches, please contact Customer Service.

Build-A-Switch

To order, simply select desired option from each category and place in the appropriate box.



Designation
ATP19 Series

Actuator Style
S Standard
R Raised
D Dome without LED only

Actuator Indicator
L0 Without LED
L1 Fix ring
L2 Spot
L3 Moving ring (standard actuator only)
L4 Power logo*
L5 Moving ring & Power logo* (standard actuator only)

LED Illumination

Color	Dual color
0 Without LED	A Red & Green
2 White	B Red & Blue
3 Red	D Blue & Yellow
5 Yellow	G Red & Yellow
6 Green	H Green & Yellow
7 Blue	J Orange & Green

LED voltage (20mA)
00 Without LED
03 3V
06 6V
12 12V
24 24V
36 36V
A1 110V AC
A2 220V AC

Terminal plating
Q Silver
G Gold

Termination
03 STD solder lug
04 Short solder lug
W1 Wire lead 500mm **
W2 Wire lead 1,000mm **

Mechanical function
A Momentary
E Lock

Contact arrangement
S SPDT
D DPDT

Bushing type

Round	Double D shape
B0 Stainless (Natural)	M0 Stainless (Natural)
B1 Brass (Mirror Chrome Plated)	M1 Brass (Mirror Chrome plated)
B2 Brass (Nickel plated)	M2 Brass (Nickel plated)
B3 Al alloy (Black anodized)	M3 Al alloy (Black anodized)

* Available on double D-shape bushing only.
** Available upon request, please contact your sales representative for details.

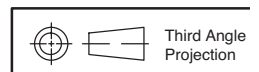

Dimensions are shown: mm (inches)
Specifications and dimensions subject to change



11 Apr 19



ATP19 Series Anti-Vandal Sealed Pushbutton Switch

NEW

Pushbutton
A

STANDARD VIEW

ROUND BUSHING

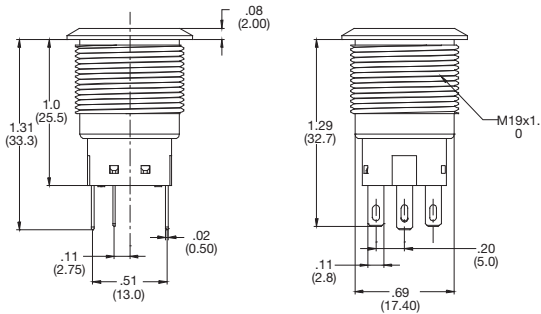

DOUBLE-D BUSHING

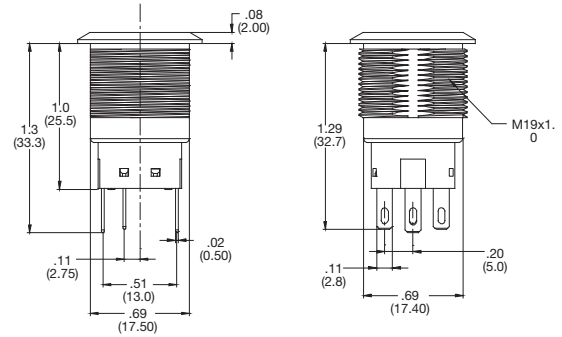

ACTUATOR STYLE

S STANDARD

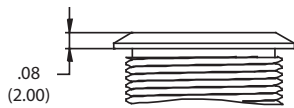

R RAISED

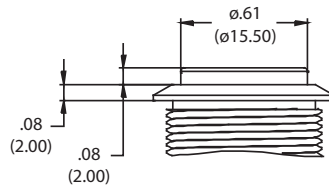

D DOME

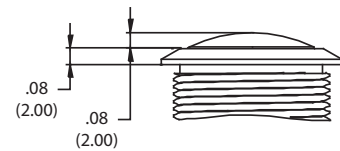

ACTUATOR INDICATOR

L0 WITHOUT LED

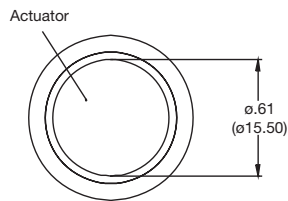

L1 FIX RING

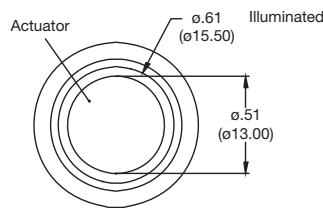

L3 MOVING RING

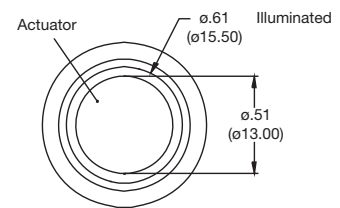

L2 SPOT

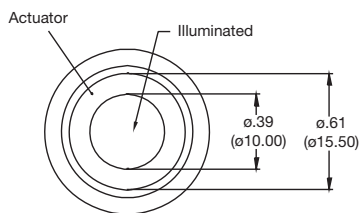

L4 POWER LOGO

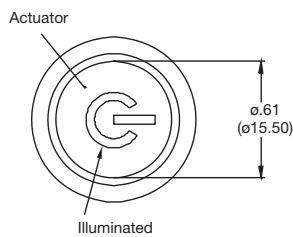

L5 POWER & MOVING RING

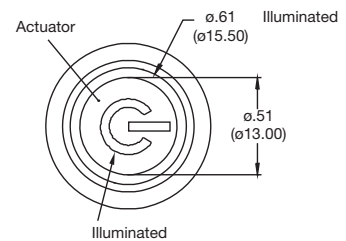

NEW

ATP19 Series Anti-Vandal Sealed Pushbutton Switch



A
Pushbutton

CIRCUIT

SPDT

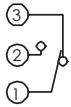

SPDT - SINGLE COLOR LED

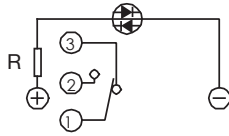

SPDT - DUAL COLOR LED

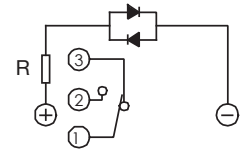

DPDT

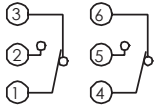

DPDT - SINGLE COLOR LED

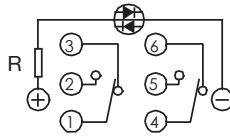

DPDT - DUAL COLOR LED

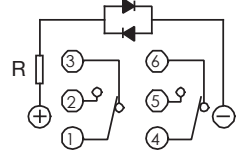

TERMINATION

03 SOLDERLUG

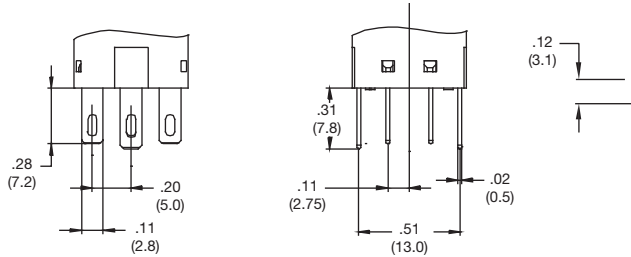

04 SHORT SOLDER LUG

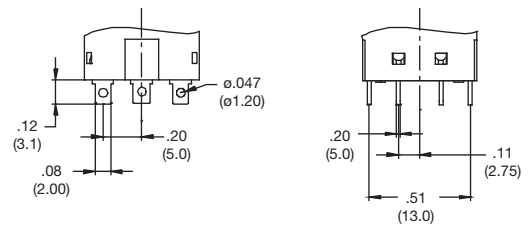

W1 OR W2 WIRE LEAD

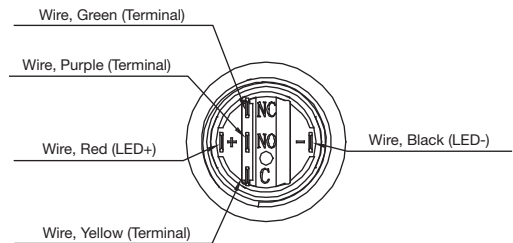
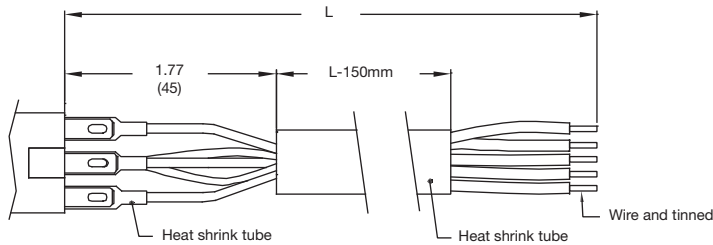

HARDWARE

HEX NUT

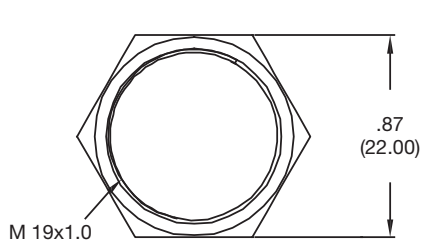

O - RING

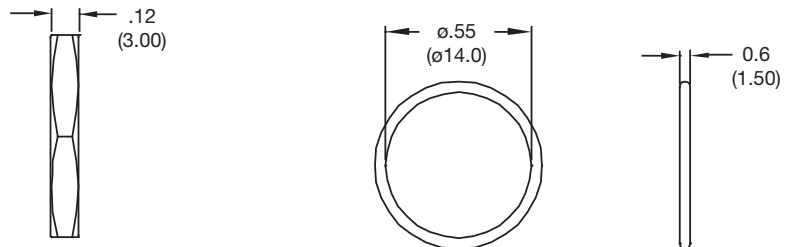



Компания «ЭлектроПласт» предлагает заключение долгосрочных отношений при поставках импортных электронных компонентов на взаимовыгодных условиях!

Наши преимущества:

- Оперативные поставки широкого спектра электронных компонентов отечественного и импортного производства напрямую от производителей и с крупнейших мировых складов;
- Поставка более 17-ти миллионов наименований электронных компонентов;
- Поставка сложных, дефицитных, либо снятых с производства позиций;
- Оперативные сроки поставки под заказ (от 5 рабочих дней);
- Экспресс доставка в любую точку России;
- Техническая поддержка проекта, помощь в подборе аналогов, поставка прототипов;
- Система менеджмента качества сертифицирована по Международному стандарту ISO 9001;
- Лицензия ФСБ на осуществление работ с использованием сведений, составляющих государственную тайну;
- Поставка специализированных компонентов (Xilinx, Altera, Analog Devices, Intersil, Interpoint, Microsemi, Aeroflex, Peregrine, Syfer, Eurofarad, Texas Instrument, Miteq, Cobham, E2V, MA-COM, Hittite, Mini-Circuits, General Dynamics и др.);

Помимо этого, одним из направлений компании «ЭлектроПласт» является направление «Источники питания». Мы предлагаем Вам помощь Конструкторского отдела:

- Подбор оптимального решения, техническое обоснование при выборе компонента;
- Подбор аналогов;
- Консультации по применению компонента;
- Поставка образцов и прототипов;
- Техническая поддержка проекта;
- Защита от снятия компонента с производства.



Как с нами связаться

Телефон: 8 (812) 309 58 32 (многоканальный)

Факс: 8 (812) 320-02-42

Электронная почта: org@eplast1.ru

Адрес: 198099, г. Санкт-Петербург, ул. Калинина, дом 2, корпус 4, литера А.