

Power Panel Potentiometer



FEATURES

- High power rating (6 W at 50 °C)
- Cermet element
- Full sealing
- Mechanical strength
- Industrial and professional grade
- Tests according to CECC 41 000



DIMENSIONS in millimeters

PE 60 L

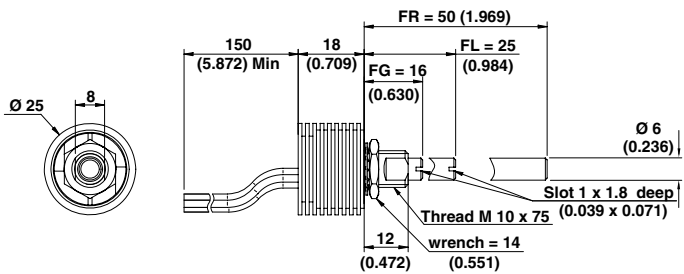

PE 60 F

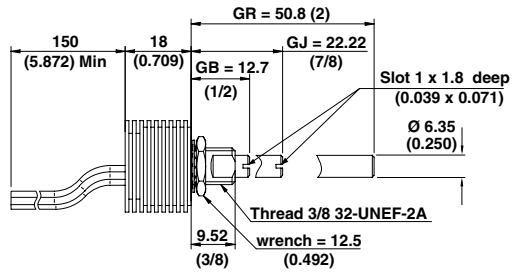

OPTION D: DBAN SHAFT LOCKING

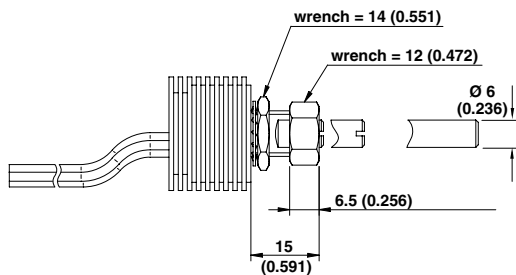

Available only with PE 60 L

OPTION L: PE 60 LPRP - WITH LOCATING PEG

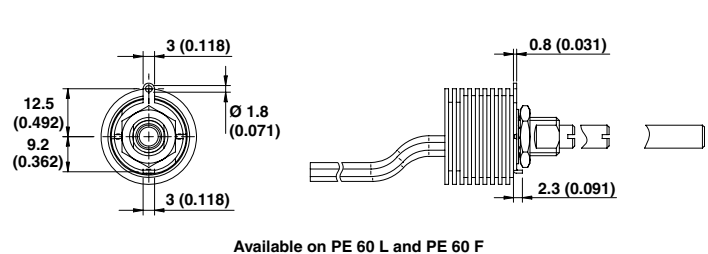

Available on PE 60 L and PE 60 F

Panel sealed version

PE 60 M

OPTION E: Including locating peg (available only for PE 60 M)

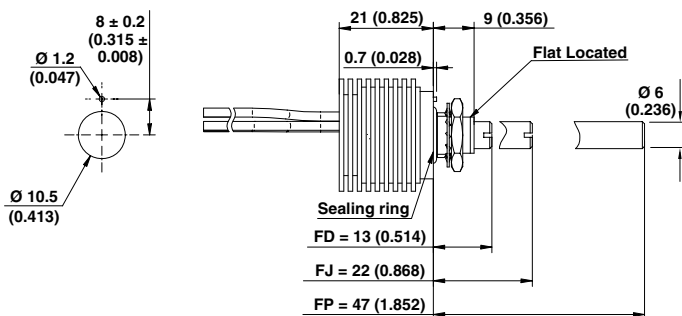

Available only with bushing M10 x 0.75 and shafts Ø 6 mm

CIRCUIT DIAGRAM

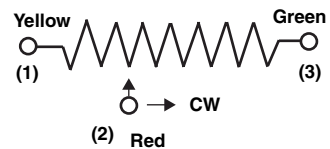

**SPECIAL FEATURES
COMMAND SHAFT**

Length is measured from the mounting surface to the free end of the shaft. The screwdriver slot is aligned with the wiper within $\pm 10^\circ$. Special shafts are available, in accordance to drawings supplied by customers. We recommend that customers should not machine shafts, in order to avoid damage.

PANEL SEALING: PE60M

The panel sealing device consists of a ring located in a slot on the potentiometer face. Sealing is obtained by tightening the ring against the panel when mounting the potentiometer.

SHAFT LOCKING: DBAN

The shaft locking device consists of a tapered nut tightening a slotted notched washer against both bushing and shaft. DBAN tightening torque is 200 Ncm, shaft locking torque being 30 Ncm.

DBAN is also available with all special types.

This device is normally supplied in a separate bag. Can be pre-mounted on request.

LOCATING PEG: LPRP

Location is obtained by fitting a special washer on the potentiometer face. The peg can therefore be positioned at 90° , 180° , 270° and 360° .

| ELECTRICAL SPECIFICATIONS | | |
|---|------------------|---------------------------------------|
| Resistive Element | | cermet |
| Electrical Travel | | $270^\circ \pm 10^\circ$ |
| Resistance Range | Linear Law | 1Ω to $1 \text{ M}\Omega$ |
| | Logarithmic Laws | 100Ω to $2.2 \text{ M}\Omega$ |
| Standard series E3 | | 1 - 2 - 2.5 - 5 |
| Tolerance | Standard | $\pm 20 \%$ |
| | On Request | $\pm 10 \%$ - $\pm 5 \%$ |
| Power Rating | Linear | 6 W at $+ 50^\circ \text{C}$ |
| | Logarithmic | 3 W at $+ 50^\circ \text{C}$ |
| Temperature Coefficient | | see Standard Resistance Element Data |
| Limiting Element Voltage (Linear Law) | | 350 V |
| Contact Resistance Variation (Linear Law) | | 3 % R_n or 0.5Ω |
| End Resistance (Typical) | | 0.5Ω or 1 % |
| Dielectric Strength (RMS) | | 2500 V |
| Insulation Resistance (500 VDC) | | $10^6 \text{ M}\Omega$ |

MECHANICAL SPECIFICATIONS

| | |
|---|-------------------------|
| Mechanical Travel | $300^\circ \pm 5^\circ$ |
| Operating Torque (max. Ncm) | 3 typical |
| End Stop Torque (max. Ncm) | 70 |
| Max Tightening Torque of Mounting Nut (Ncm) | 250 |
| Unit Weight (max. g) | 25 to 35 |

ENVIRONMENTAL SPECIFICATIONS

| | |
|-------------------|---|
| Temperature Range | $- 55^\circ \text{C}$ to $+ 125^\circ \text{C}$ |
| Climatic Category | 55/125/56 |
| Sealing | fully sealed container IP67 |

POWER RATING CHART

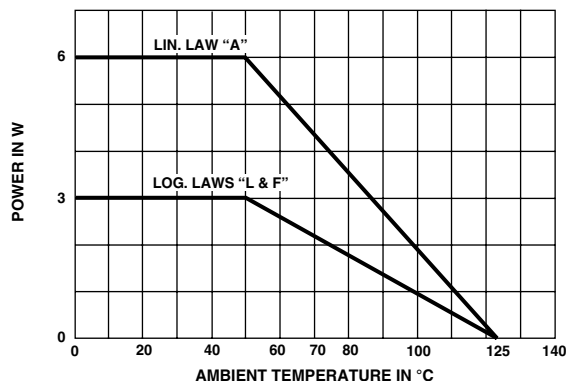

RESISTANCE LAWS

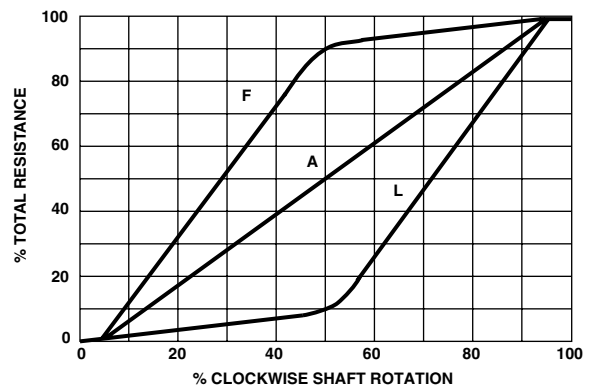



| PERFORMANCE | | | |
|--------------------------|--|--|--------------------------------------|
| TESTS | CONDITIONS | TYPICAL VALUES AND DRIFTS | |
| | | $\frac{\Delta RT}{RT}$ (%) | $\frac{\Delta R_{1-2}}{R_{1-2}}$ (%) |
| Climatic Sequence | Phase A dry heat 125 °C Phase B damp heat Phase C cold - 55 °C Phase D damp heat 5 cycles | ± 0.5 % | ± 1 % |
| Long Term Damp Heat | 56 days | ± 0.5 % Insulation resistance: > 10 ⁴ MΩ | ± 1 % |
| Rotational Life | 25 000 cycles | ± 3 % Contact res. variation: < 5 % Rn | |
| Load Life | 1000 hours at rated power 90°/30° - ambient temp. 25 °C | ± 3 % Contact res. variation: < 3 % Rn | |
| Rapid Temperature Change | 5 cycles - 55 °C at + 125 °C | ± (0.5 % ± 0.1 Ω) | |
| Shock | 50 g at 11 ms 3 successive shocks in 3 directions | ± 0.1 % | ± 0.2 % |
| Vibration | 10 - 55 Hz 0.75 mm or 10 g during 6 hours | ± 0.1 % | ± 0.2 % |

| STANDARD RESISTANCE ELEMENT DATA | | | | |
|----------------------------------|---------------------|----------------------|-------------------------|------------------------------------|
| STANDARD RESISTANCE VALUES | LINEAR LAW | | | TYPICAL TCR - 55 °C + 125 °C |
| | MAX. POWER AT 25 °C | MAX. WORKING VOLTAGE | MAX. CUR. THROUGH WIPER | |
| Ω | W | V | mA | ppm/°C |
| 1 | 6 | 2.4 | 2449 | ± 500 |
| 2 | ↓ | 3.5 | 1732 | |
| 5 | | 5.5 | 1095 | |
| 10 | | 7.7 | 775 | |
| 20 | | 11.0 | 548 | |
| 25 | | 12.2 | 490 | |
| 50 | ↓ | 17.3 | 346 | ± 250 |
| 100 | | 24.5 | 245 | |
| 200 | | 34.6 | 173.2 | |
| 250 | | 38.7 | 154.9 | |
| 500 | | 54.8 | 109.5 | |
| 1K | | 77.5 | 77.5 | |
| 2K | | 110 | 54.8 | |
| 2.5K | | 122 | 49.0 | |
| 5K | | 173 | 34.64 | |
| 10K | | 245 | 24.49 | |
| 20K | 6 | 346 | 17.32 | |
| 25K | 4.90 | 350 | 14.00 | |
| 50K | 2.45 | ↓ | 7.00 | |
| 100K | 1.23 | | 3.50 | |
| 200K | 0.61 | | 1.75 | |
| 250K | 0.49 | | 1.40 | |
| 500K | 0.25 | | 0.70 | |
| 1M | 0.12 | 350 | 0.35 | |

MARKING

- Printed:
- VISHAY trademark
 - SAP Part number
 - manufacturing date

PACKAGING

- in box of 5 pieces



| SAP ORDERING INFORMATION (Part Number 18 digits) | | | | | | | | | | | | | | | | | |
|--|---|---|---|---|---|---|---|---------|--------------|---|---|--|---|--|--|--|--|
| P | E | 6 | 0 | L | 0 | F | G | W | 2 | 0 | 4 | M | A | | | | |
| MODEL | BUSHING | OPTION | | | SHAFT | | | LEADS | OHMIC VALUE | TOLERANCE | | LAW | | SPECIAL NUMBER | | | |
| | M = Panel sealed L = STD F = 3/8" | 0 = none For L Bushing D = DBAN L = LPRP B = DBAN and LPRP For F Bushing L = LPRP For M Bushing E = Peg | | | For L Bushing FG 16 mm, slotted FL 25 mm, slotted FR 50 mm, plain For F Bushing GB 1/2", slotted GJ 7/8", slotted GR 2", slotted For M Bushing FD = 13 mm, slotted FJ = 22 mm, slotted FP = 47 mm, plain | | | W: Wire | 204 = 200 kΩ | ± 20 % on request ± 10 % ± 5 % | | A = Linear L = clockwise logarithmic F = clockwise inverse logarithmic | | (if applicable) Given by VISHAY for custom design | | | |

| PART NUMBER DESCRIPTION (for information only) | | | | | | | | | | | |
|--|---------|--------|-------|-------|-------------|------|-----|-----------|---------|---------|----------------|
| PE60 | L | 0 | FG | W | 200 kΩ | 20 % | A | BO5 | | | e3 |
| MODEL | BUSHING | OPTION | SHAFT | LEADS | OHMIC VALUE | TOL | LAW | PACKAGING | SPECIAL | SPECIAL | LEAD (Pb)-FREE |



Notice

Specifications of the products displayed herein are subject to change without notice. Vishay Intertechnology, Inc., or anyone on its behalf, assumes no responsibility or liability for any errors or inaccuracies.

Information contained herein is intended to provide a product description only. No license, express or implied, by estoppel or otherwise, to any intellectual property rights is granted by this document. Except as provided in Vishay's terms and conditions of sale for such products, Vishay assumes no liability whatsoever, and disclaims any express or implied warranty, relating to sale and/or use of Vishay products including liability or warranties relating to fitness for a particular purpose, merchantability, or infringement of any patent, copyright, or other intellectual property right.

The products shown herein are not designed for use in medical, life-saving, or life-sustaining applications. Customers using or selling these products for use in such applications do so at their own risk and agree to fully indemnify Vishay for any damages resulting from such improper use or sale.



Компания «ЭлектроПласт» предлагает заключение долгосрочных отношений при поставках импортных электронных компонентов на взаимовыгодных условиях!

Наши преимущества:

- Оперативные поставки широкого спектра электронных компонентов отечественного и импортного производства напрямую от производителей и с крупнейших мировых складов;
- Поставка более 17-ти миллионов наименований электронных компонентов;
- Поставка сложных, дефицитных, либо снятых с производства позиций;
- Оперативные сроки поставки под заказ (от 5 рабочих дней);
- Экспресс доставка в любую точку России;
- Техническая поддержка проекта, помощь в подборе аналогов, поставка прототипов;
- Система менеджмента качества сертифицирована по Международному стандарту ISO 9001;
- Лицензия ФСБ на осуществление работ с использованием сведений, составляющих государственную тайну;
- Поставка специализированных компонентов (Xilinx, Altera, Analog Devices, Intersil, Interpoint, Microsemi, Aeroflex, Peregrine, Syfer, Eurofarad, Texas Instrument, Miteq, Cobham, E2V, MA-COM, Hittite, Mini-Circuits, General Dynamics и др.);

Помимо этого, одним из направлений компании «ЭлектроПласт» является направление «Источники питания». Мы предлагаем Вам помощь Конструкторского отдела:

- Подбор оптимального решения, техническое обоснование при выборе компонента;
- Подбор аналогов;
- Консультации по применению компонента;
- Поставка образцов и прототипов;
- Техническая поддержка проекта;
- Защита от снятия компонента с производства.



Как с нами связаться

Телефон: 8 (812) 309 58 32 (многоканальный)

Факс: 8 (812) 320-02-42

Электронная почта: org@eplast1.ru

Адрес: 198099, г. Санкт-Петербург, ул. Калинина, дом 2, корпус 4, литера А.