

### FEATURES

- UL 60950 recognition pending for reinforced insulation
- ANSI/AAMI ES60601-1, 2 MOOPs recognition pending
- 3kVAC isolation test voltage 'Hi Pot Test'
- Output Voltage Trim
- Remote on/off pin
- No electrolytic capacitors
- Operating temperature range -40°C to 105°C
- 2:1 Input Range

### PRODUCT OVERVIEW

The MTC1 series of miniature surface mount DC/DC converters offers a single output voltage from input voltage ranges of 4.5-18V and 9-36V. The MTC1 series regulated output voltage is adjustable by  $\pm 10\%$  and a remote on/off pin is also included for application power saving.

The MTC1 ideally suited to applications which include medical, industrial, telecommunications, battery powered systems, and process automation.

### SELECTION GUIDE

Order Code <sup>1</sup>	Input Voltage	Output Voltage	Output Current	Rated Input Current	Efficiency		Ripple and Noise		Switching Frequency	MTTF <sup>2</sup>
	Nom.				Min.	Typ.	Typ.	Max.	Typ.	
	V	V	mA		%	%	mVp/p	mVp/p	kHz	
MTC1S1203MC	12	3.3	303	111	71	75			240	1143
MTC1S1205MC	12	5	200	106	75	78			260	1129
MTC1S1212MC	12	12	83	103	76	79			290	977
MTC1S2403MC	24	3.3	303	55	72	75			230	1042
MTC1S2405MC	24	5	200	54	73	76			240	990
MTC1S2412MC	24	12	83	53	73	77			260	833

### INPUT CHARACTERISTICS

Parameter	Conditions	Min.	Typ.	Max.	Units
Voltage range	12V input types	9	12	18	V
	24V input types	18	24	36	
Input reflected ripple current	MTC1S12XX				mA p-p
	MTC1S24XX				
Inrush Current	12V input types			13	A
	24V input types			25	A

### OUTPUT CHARACTERISTICS

Parameter	Conditions	Min.	Typ.	Max.	Units
Rated power	All output types			1	W
Minimal load to meet datasheet specification		10			%
Voltage set point accuracy	All output types		$\pm 1$	$\pm 2$	%
Line regulation	Low line to high line			$\pm 0.5$	%
Load regulation	All output types			$\pm 0.5$	%
Transient response	Peak deviation (12.5-37.5% & 37.5-12.5% swing)			5	$\%V_{out}$
	Settling time (within 5% $V_{out}$ Nom.)		1		ms

### ISOLATION CHARACTERISTICS

Parameter	Conditions	Min.	Typ.	Max.	Units
Isolation test voltage	Flash tested for 1 second	3000			VAC
Isolation capacitance	All variants		7		pF
Resistance	Viso = 1kVDC	1			GΩ

### GENERAL CHARACTERISTICS<sup>1</sup>

Parameter	Conditions	Min.	Typ.	Max.	Units
Remote on/off pin	Module on, pin unconnected or open collector floating				
	Module off		2		V



1. Components are supplied in tape and reel packaging, please refer to package specification section. Orderable part numbers are MTC1SXXXXMC-R7 (30 pieces per reel), or MTC1SXXXXMC-R13 (150 pieces per reel)  
 2. Calculated using MIL-HDBK-217 FN2 calculation model with nominal input voltage at full load.

All specifications typical at  $T_A=25^\circ\text{C}$ , nominal input voltage and rated output current unless otherwise specified.

## TEMPERATURE CHARACTERISTICS

Parameter	Conditions	Min.	Typ.	Max.	Units
Operation		-40		105	°C
Storage		-50		125	
Case temperature above ambient	100% Load, Nom $V_{in}$ , Still Air				

## ABSOLUTE MAXIMUM RATINGS

Short-circuit protection (for SELV input voltages)	
Remote on/off pin input voltage	
Lead temperature 1.0mm from case for 10 seconds (to JEDEC JESD22-B106 ISS C)	260°C
Input voltage, MTC1 12V input types	25V
Input voltage, MTC1 24V input types	40V

## APPLICATION NOTES

### Maximum Output Capacitance

Maximum output capacitance should not exceed:

Output Voltage	Maximum Load Capacitance
V	$\mu\text{F}$
3.3	470
5	470
12	220

### Start-up times

Typical start up times for this series, with a typical input voltage rise time of 2.2 $\mu\text{s}$  and output capacitance of 10 $\mu\text{F}$ , are shown in the table below. The product series will start into a capacitance of 47 $\mu\text{F}$  with an increased start time, however the maximum recommended output capacitance is 10 $\mu\text{F}$ .

Part No.	Start-up times
	ms
<b>MTC1S1203SC</b>	5
<b>MTC1S1205SC</b>	14
<b>MTC1S1212SC</b>	25
<b>MTC1S2403SC</b>	9
<b>MTC1S2405SC</b>	14
<b>MTC1S2412SC</b>	25

Typical Wave Form:

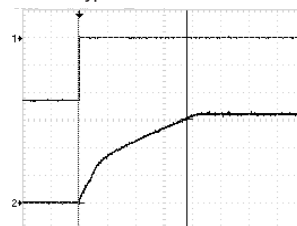

## APPLICATION NOTES

### Control Pin

The MTC1 converters have a shutdown feature which enables the user to put the converter into a low power state. The control pin connects directly to the base of an internal transistor, and the switch off mechanism for the MTC1 works by forward biasing this NPN transistor. If the pin is left open (high impedance), the converter will be ON (there is no allowed low state for this pin), but once a control voltage is applied with sufficient drive current, the converter will be switched OFF. A suitable application circuit is shown below.

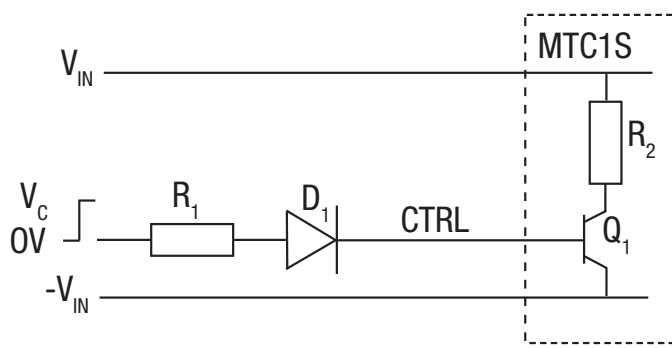

$D_1$  (e.g. 1N4001) is required to provide high impedance when the signal is low. From the MTC1 specification, the drive current to operate this function is recommended to be 3mA to 8mA, and hence the value of  $R_1$  can be derived as follows:

$$R_1 = \frac{V_c - V_D - 0.6}{I_b}$$

Assuming  $V_c=5V$ ,  $V_D=0.7V$ :

$$R_1 = \frac{5 - 0.7 - 0.6}{5 \times 10^{-3}} = 732\Omega \text{ (E96, 1\% resistor)}$$

For 5V TTL signal:  
Set  $R_1$  to be 82 $\Omega$  or less

### Output Voltage Adjustment

The MTC1S series has a trim capability which is located at pin 3, this allows the user to independently adjust the output voltages by  $\pm 10\%$ . Adjustments to the output voltages can be accomplished via a single fixed resistor as shown in Figures 1 and 2. A single fixed resistor can increase or decrease the output voltage depending on its connection. Fixed resistors should have low temperature coefficient to minimize sensitivity to changes in temperature.

A single resistor connected from the TRIM pin (pin 3) to the +Vout (pin 4), will decrease the output voltage which is shown in figure 1.

A single resistor connected from the TRIM pin (pin 3) to the -Vout (pin 2) will increase the output voltage which is shown in figure 2.

#### TRIM DOWN

Figure 1. Trim connections to decrease the output voltage

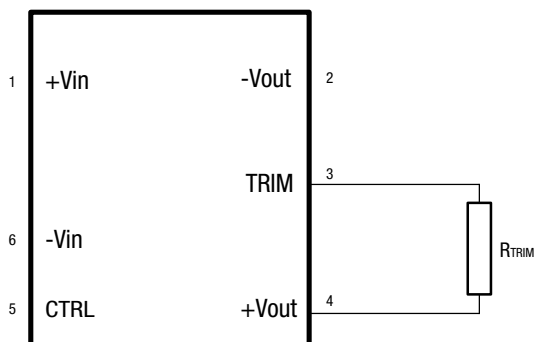

$$3.3V_{out} R_{TRIM} = \frac{18.64k \times V_{out} - 52.3k}{3.32 - V_{out}}$$

$$5V_{out} R_{TRIM} = \frac{33.2k \times V_{out} - 141k}{5 - V_{out}}$$

$$12V_{out} R_{TRIM} = \frac{12.5k \times V_{out} - 171.29k}{11.979 - V_{out}}$$

#### TRIM UP

Figure 2. Trim connections to increase the output voltage

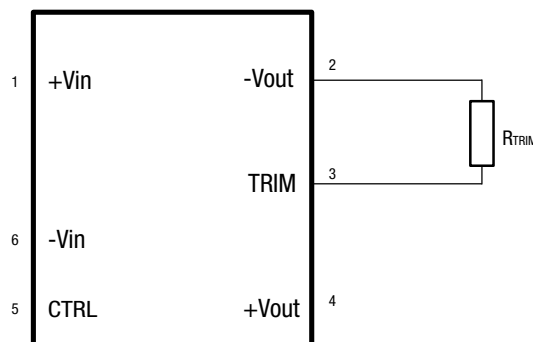

$$3.3V_{out} R_{TRIM} = \frac{14k \times V_{out} - 52.3k}{3.32 - V_{out}}$$

$$5V_{out} R_{TRIM} = \frac{23.2k \times V_{out} - 141k}{5 - V_{out}}$$

$$12V_{out} R_{TRIM} = \frac{12.4k \times V_{out} - 171.29k}{11.979 - V_{out}}$$

Accuracy of adjustment is subject to tolerances of resistors and factory adjusted output accuracy.  $V_{out}$  is equal to the desired output voltage.

## TECHNICAL NOTES

### ISOLATION VOLTAGE

'Hi Pot Test', 'Flash Tested', 'Withstand Voltage', 'Proof Voltage', 'Dielectric Withstand Voltage' & 'Isolation Test Voltage' are all terms that relate to the same thing, a test voltage, applied for a specified time, across a component designed to provide electrical isolation, to verify the integrity of that isolation.

Murata Power Solutions MTC1 series of DC/DC converters are all 100% production tested at their stated isolation voltage. This is 3kVRMS for 1 second.

A question commonly asked is, "What is the continuous voltage that can be applied across the part in normal operation?"

The MTC1 series is pending recognition by Underwriters Laboratory to 250Vrms for Reinforced Insulation.

### REPEATED HIGH-VOLTAGE ISOLATION TESTING

It is well known that repeated high-voltage isolation testing of a barrier component can actually degrade isolation capability, to a lesser or greater degree depending on materials, construction and environment. We therefore strongly advise against repeated high voltage isolation testing, but if it is absolutely required, that the voltage be reduced by 20% from specified test voltage.

## SAFETY APPROVAL

### ANSI/AAMI ES60601-1

The MTC1 series is pending recognition by Underwriters Laboratory (UL) to ANSI/AAMI ES60601-1 and provides 2 MOOP (means of operator protection) based upon a working voltage of ??? Vrms max., between Primary and Secondary.

### UL 60950

The MTC1 series is pending recognition by Underwriters Laboratory (UL) to UL 60950 for reinforced insulation to a working voltage of 250Vrms.

### FUSING

The MTC1 Series of converters are not internally fused so to meet the requirements of UL an anti-surge input line fuse should always be used with ratings as defined below.

Input Voltage, 12V ?A

Input Voltage, 24V ?A

All fuses should be UL recognized and rated to at least the maximum allowable DC input voltage.

## RoHS COMPLIANCE INFORMATION



This series is compatible with RoHS soldering systems with a peak wave solder temperature of 260°C for 10 seconds. The pin termination finish on this product series is Tin Plate, Hot Dipped over Matte Tin with Nickel Preplate. The series is backward compatible with Sn/Pb soldering systems.

## CHARACTERISATION TEST METHODS

### Ripple & Noise Characterisation Method

Ripple and noise measurements are performed with the following test configuration.

C1	1µF X7R multilayer ceramic capacitor, voltage rating to be a minimum of 3 times the output voltage of the DC/DC converter
C2	10µF tantalum capacitor, voltage rating to be a minimum of 1.5 times the output voltage of the DC/DC converter with an ESR of less than 100mΩ at 100 kHz
C3	100nF multilayer ceramic capacitor, general purpose
R1	450Ω resistor, carbon film, ±1% tolerance
R2	50Ω BNC termination
T1	3T of the coax cable through a ferrite toroid
RLOAD	Resistive load to the maximum power rating of the DC/DC converter. Connections should be made via twisted wires

Measured values are multiplied by 10 to obtain the specified values.

### Differential Mode Noise Test Schematic

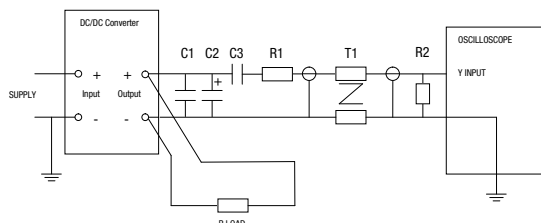

## EFFICIENCY VS LOAD

**MTC1S1203SC**

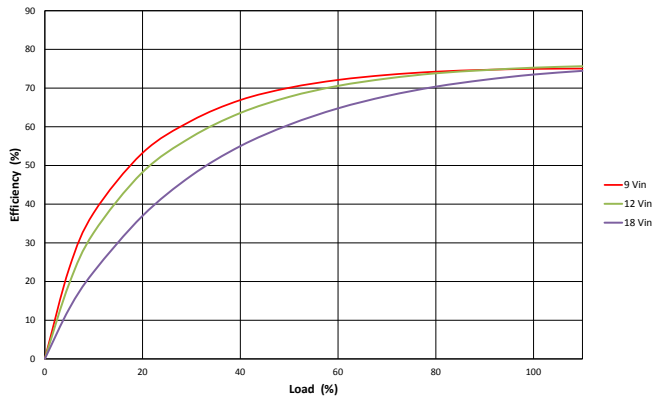

**MTC1S1205SC**

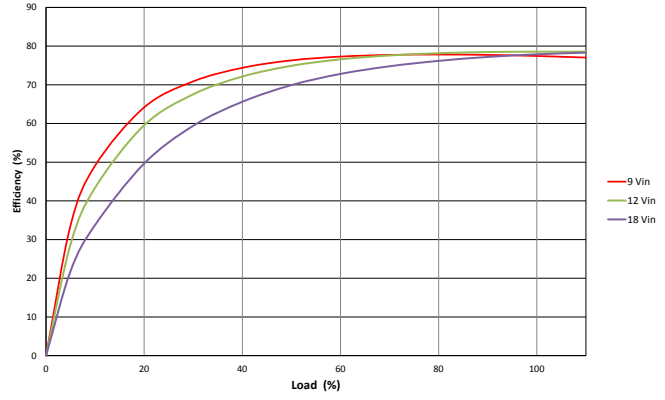

**MTC1S1212SC**

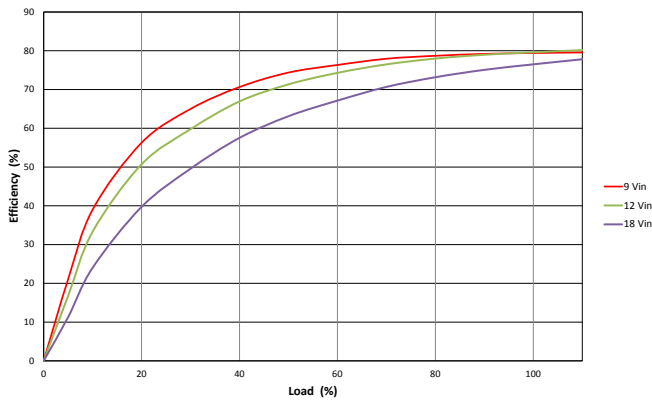

**MTC1S2403SC**

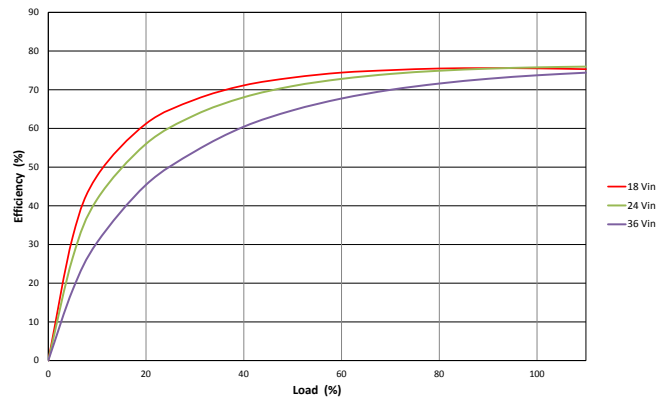

**MTC1S2405SC**

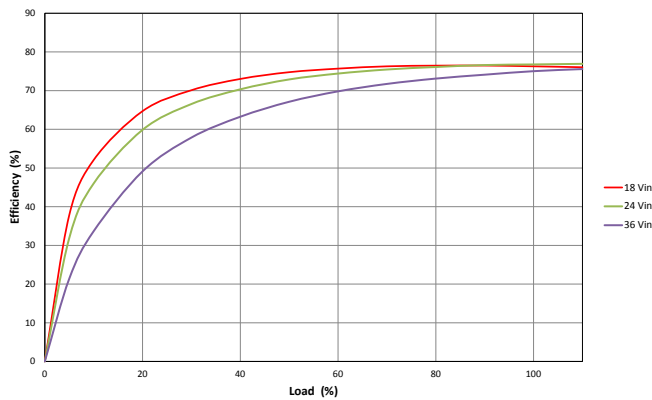

**MTC1S2412SC**

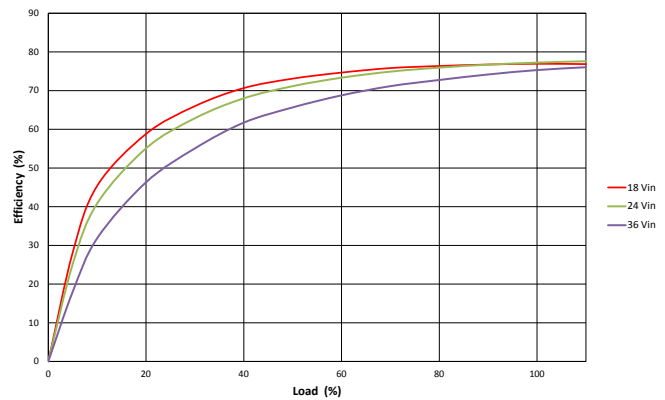

**DERATING GRAPHS**

**MTC1S1203SC - 12Vin**

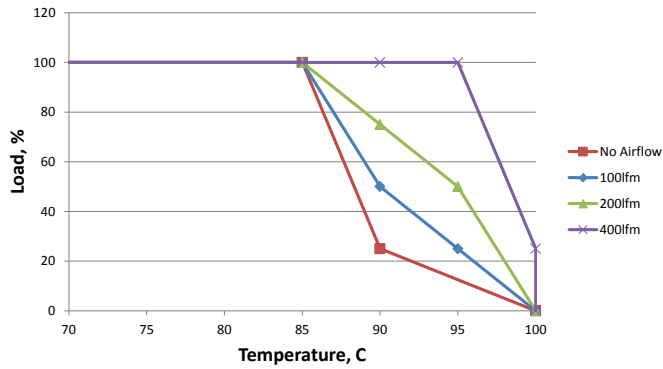

**MTC1S1205SC - 12Vin**

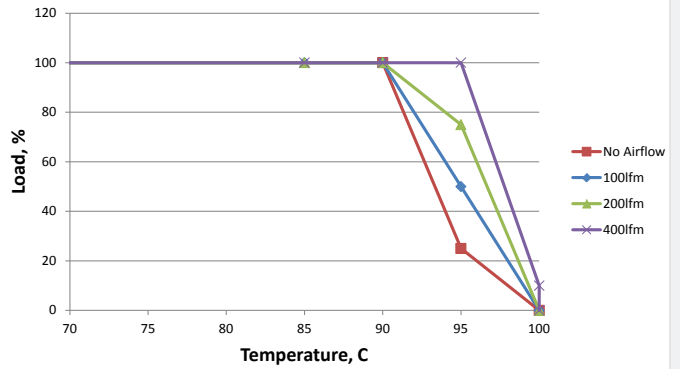

**MTC1S1212SC - 12Vin**

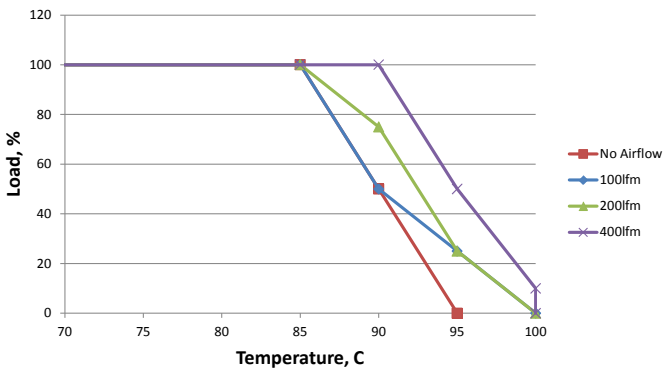

**MTC1S2403SC - 24Vin**

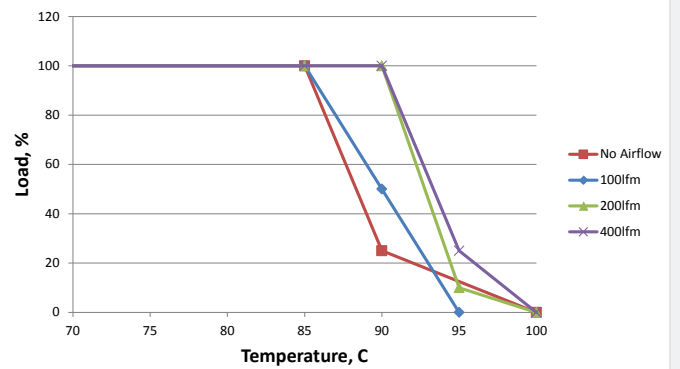

**MTC1S2405SC - 24Vin**

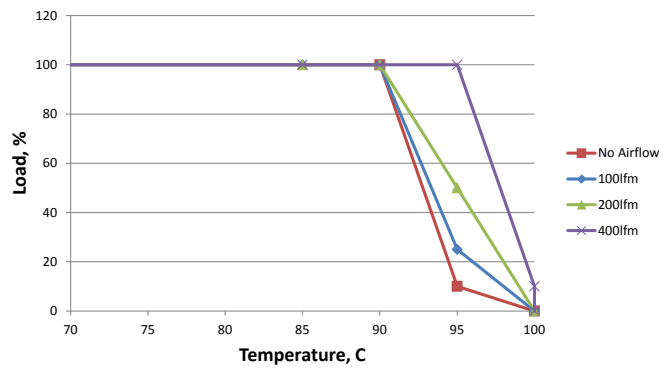

**MTC1S2412SC - 24Vin**

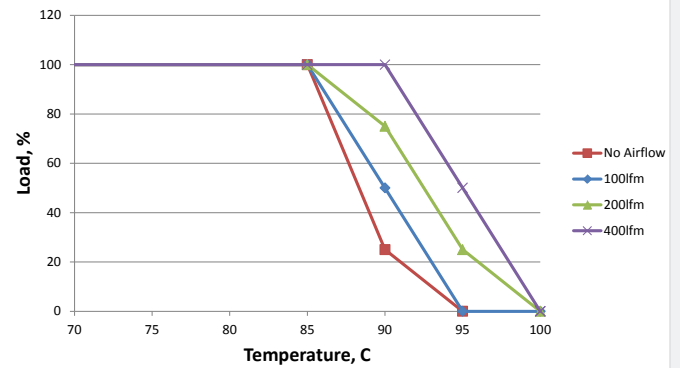

**DERATING GRAPHS**

**MTC1S1203SC - 9Vin**

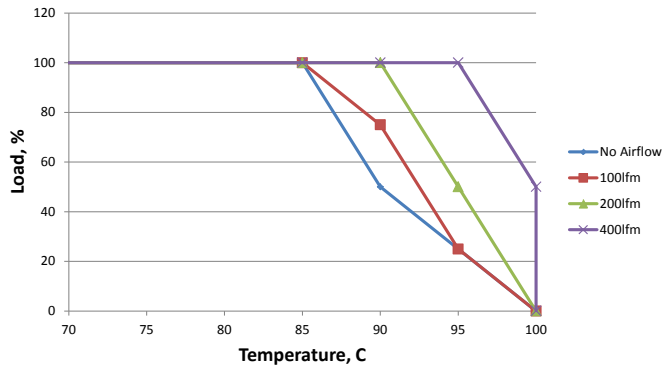

**MTC1S1205SC - 9Vin**

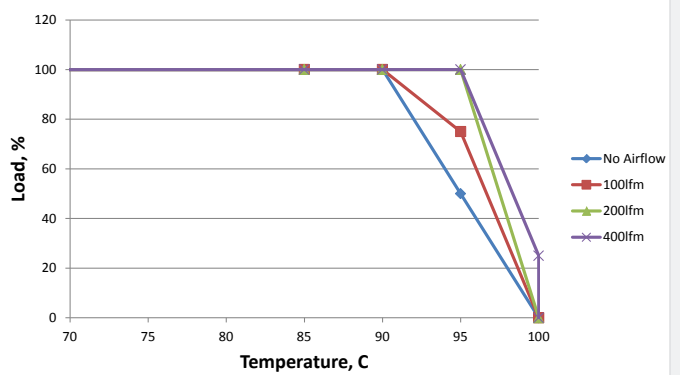

**MTC1S1212SC - 9Vin**

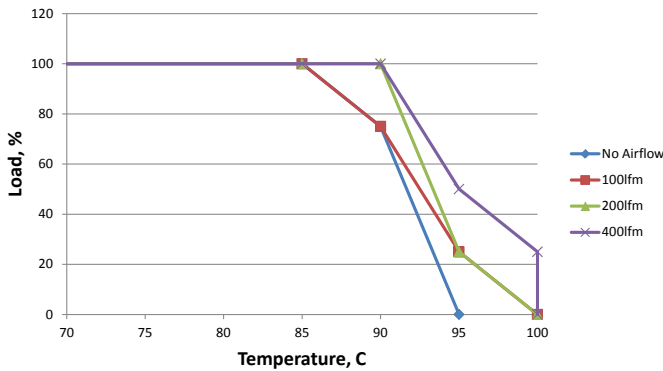

**MTC1S2403SC - 18Vin**

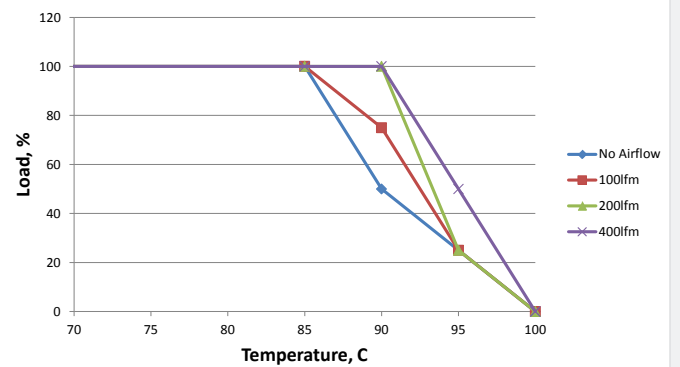

**MTC1S2405SC - 18Vin**

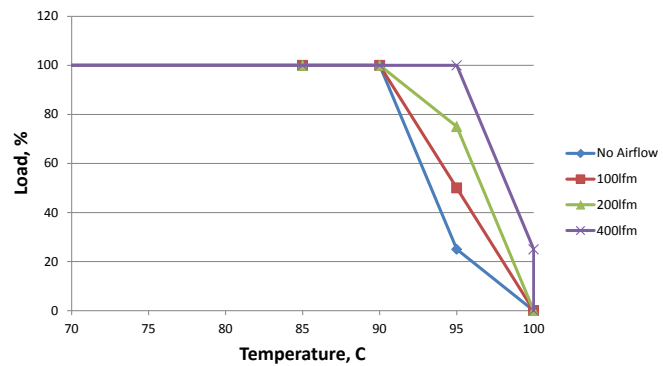

**MTC1S2412SC - 18Vin**

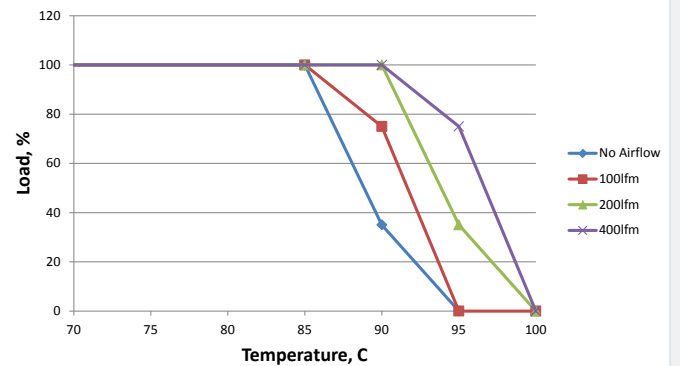

**DERATING GRAPHS**

**MTC1S1203SC - 18Vin**

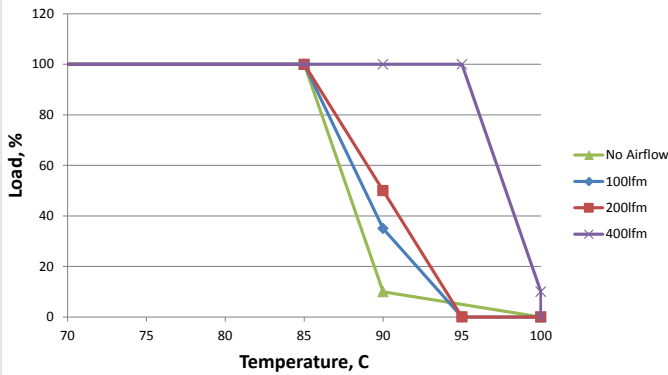

**MTC1S1205SC - 18Vin**

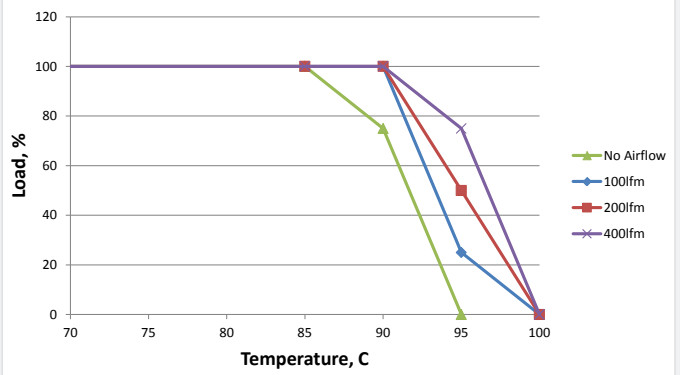

**MTC1S1212SC - 18Vin**

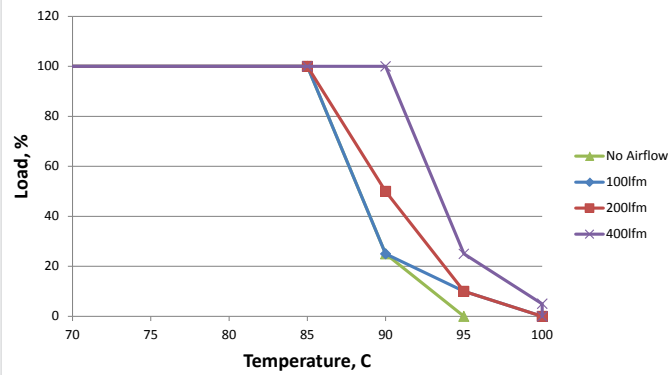

**MTC1S2403SC - 36Vin**

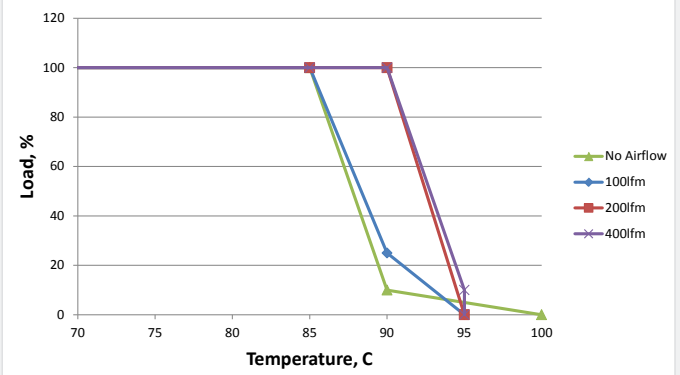

**MTC1S2405SC - 36Vin**

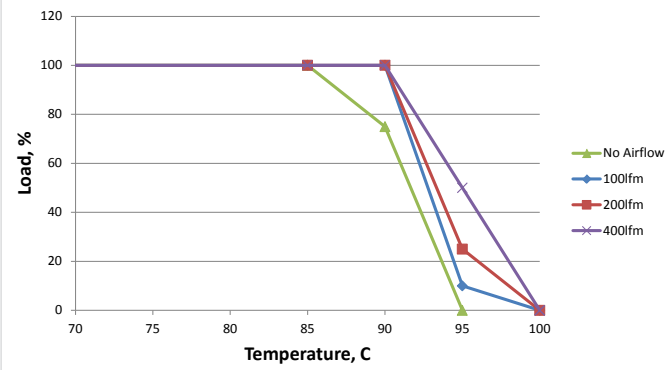

**MTC1S2412SC - 36Vin**

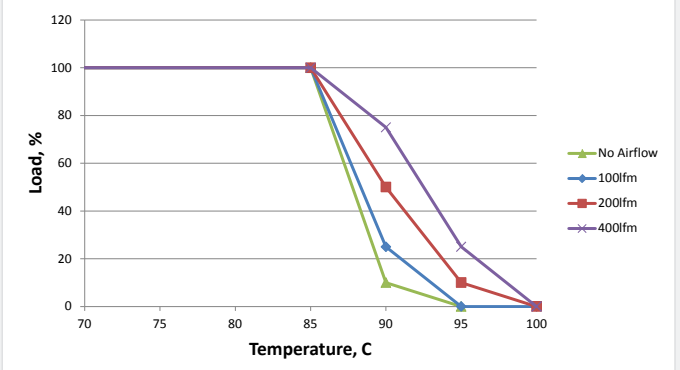



**EMC FILTERING AND SPECTRA**

**FILTERING**

The module includes a basic level of filtering. With the addition of an input capacitor of 680nF and input inductor 10μH that are typically required to meet EN 55022 Curve A Quasi-Peak EMC limit, as shown in the following plots.

**MTC1S1203SC**

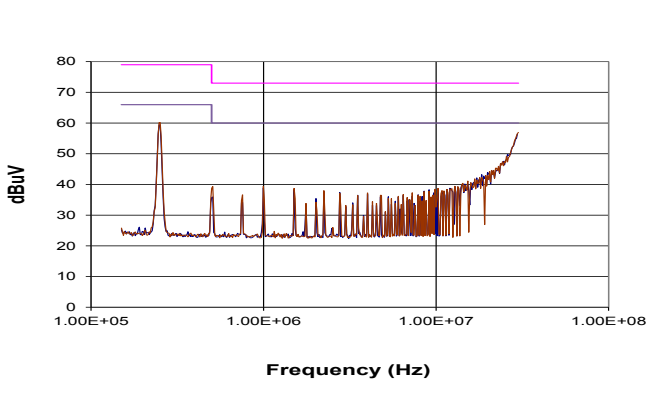

**MTC1S1205SC**

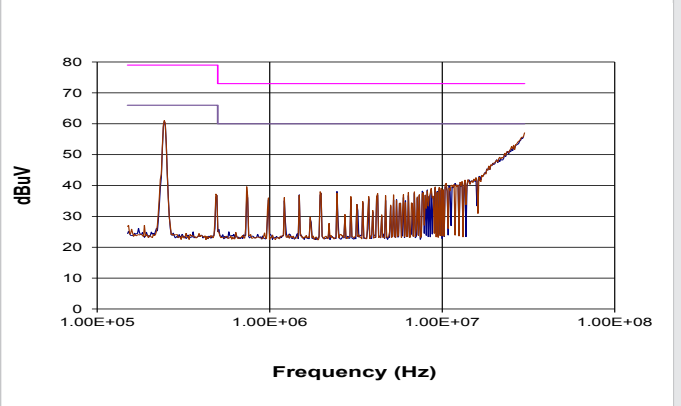

**MTC1S1212SC**

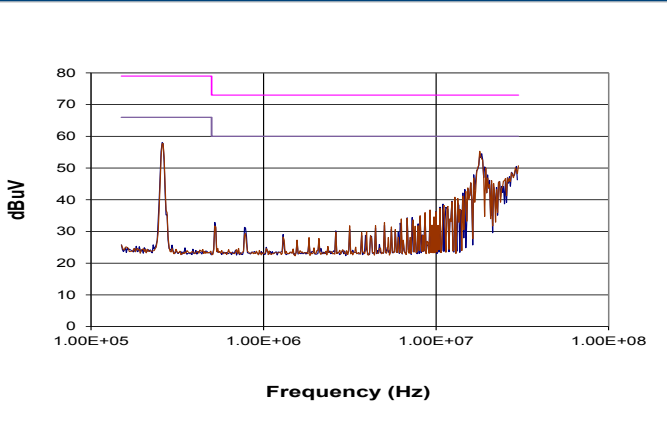

**MTC1S2403SC**

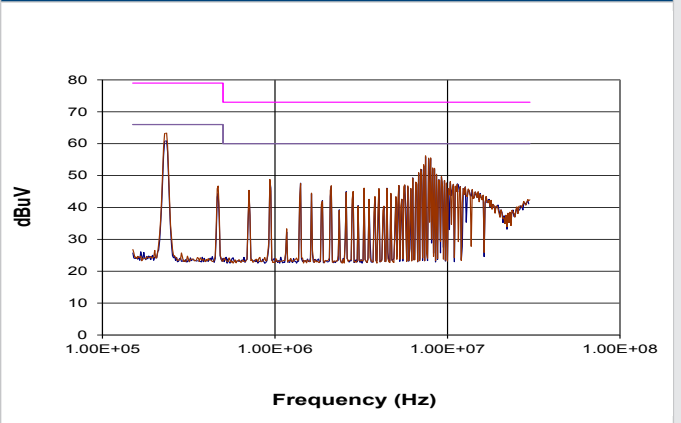

**MTC1S2405SC**

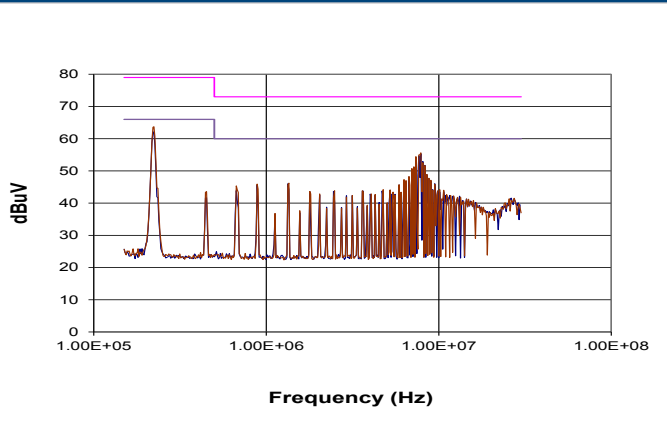

**MTC1S2412SC**

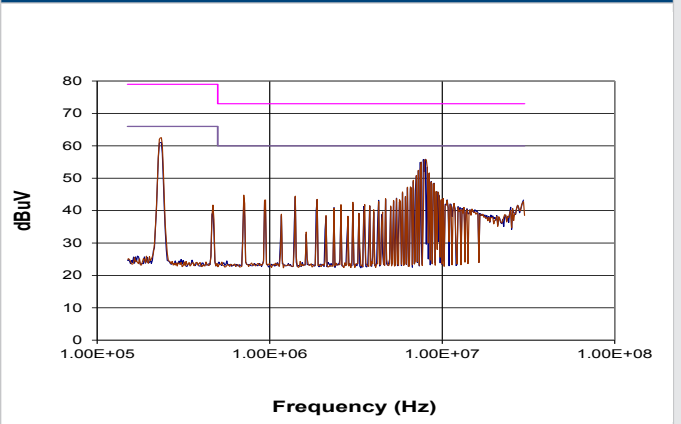

## PACKAGE SPECIFICATIONS

### Mechanical Dimensions

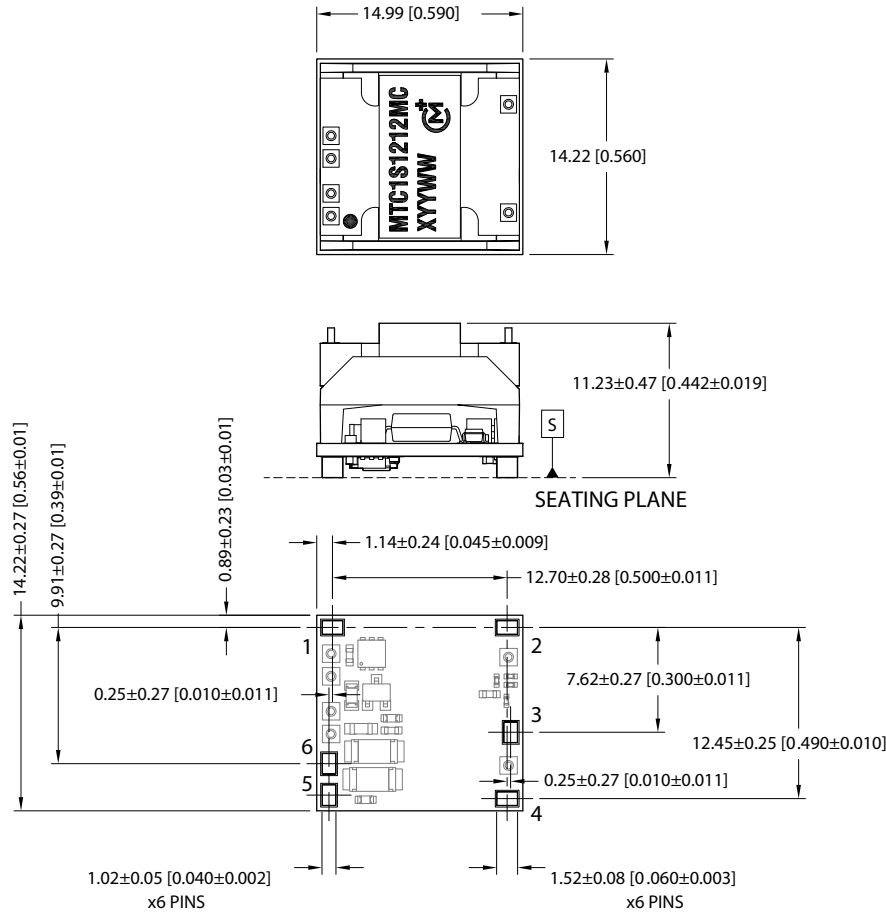

All dimensions in mm(inches), Controlling dimension is mm. Tolerances (unless otherwise stated)  $\pm 0.10(0.004)$ .

Weight: 3.4g

### Pin Connections

Pin	Function
1	+Vin
2	-Vout
3	Trim
4	+Vout
5	Ctrl
6	-Vin

### Recommended Footprint Details

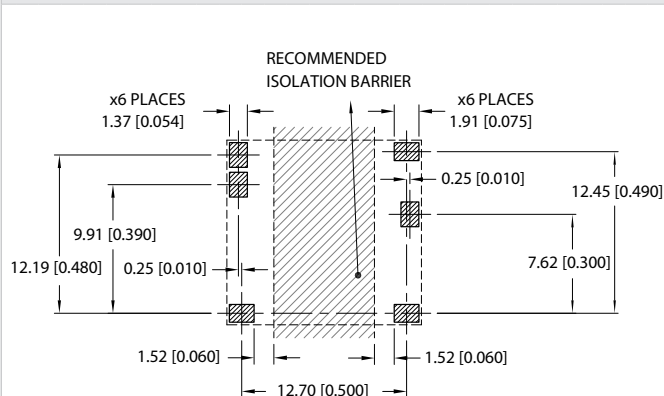

## TAPE & REEL SPECIFICATIONS

### REEL OUTLINE DIMENSIONS

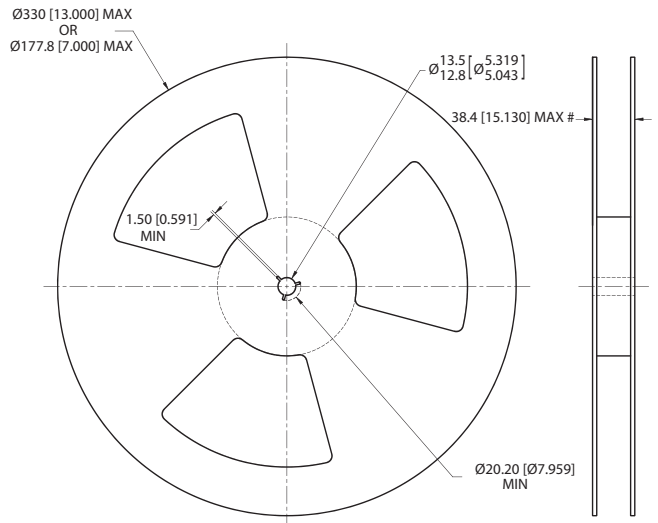

Tape & Reel specifications shall conform with current EIA-481 standard  
 Unless otherwise stated all dimensions in mm (inches)  
 Controlling dimension is mm  
 # Measured at hub

### REEL PACKAGING DETAILS

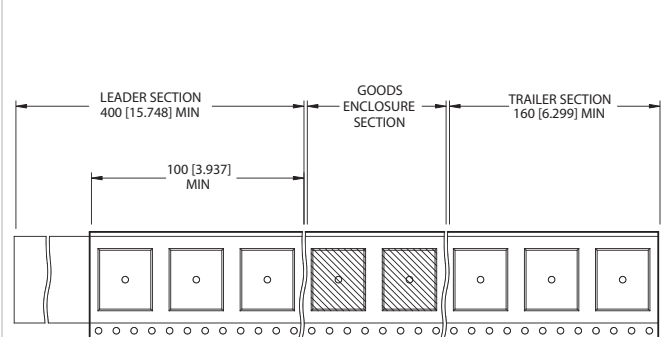

Carrier tape pockets shown are illustrative only - Refer to carrier tape diagram for actual pocket details.

Reel Quantity: 7" - 30 or 13" - 150

### TAPE OUTLINE DIMENSIONS

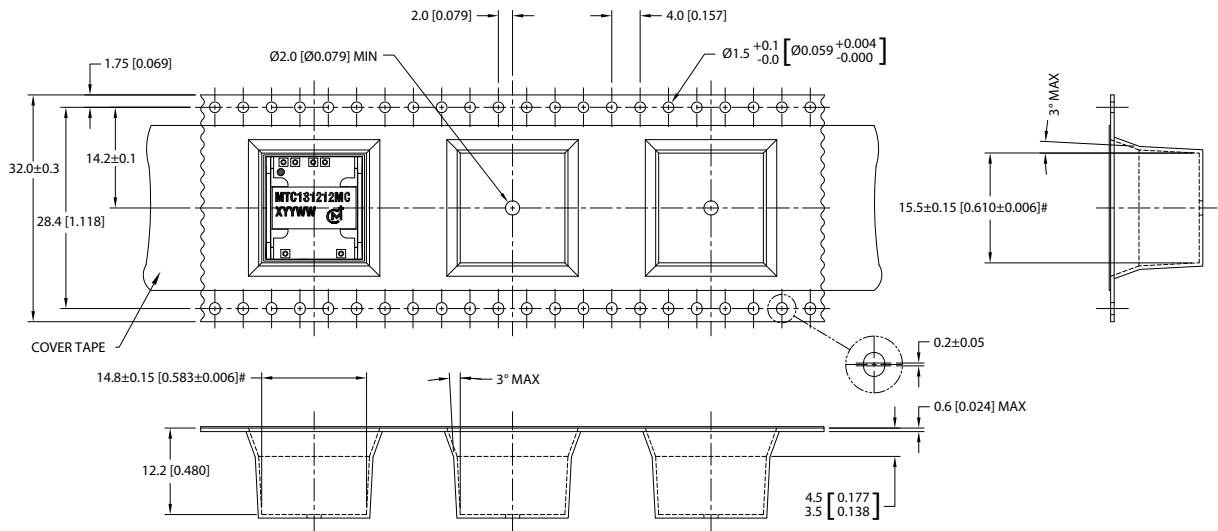

Tape & Reel specifications shall conform with current EIA-481 standard  
 Unless otherwise stated all dimensions in mm (inches) ±0.1mm (±0.004 Inches)  
 Controlling dimension is mm  
 Components shall be orientated within the carrier tape as indicated  
 # Measured on a plane 0.3mm above the bottom pocket

Murata Power Solutions, Inc.  
 11 Cabot Boulevard, Mansfield, MA 02048-1151 U.S.A.  
 ISO 9001 and 14001 REGISTERED



This product is subject to the following [operating requirements](#) and the [Life and Safety Critical Application Sales Policy](#):  
 Refer to: <http://www.murata-ps.com/requirements/>

Murata Power Solutions, Inc. makes no representation that the use of its products in the circuits described herein, or the use of other technical information contained herein, will not infringe upon existing or future patent rights. The descriptions contained herein do not imply the granting of licenses to make, use, or sell equipment constructed in accordance therewith. Specifications are subject to change without notice. © 2015 Murata Power Solutions, Inc.



Компания «ЭлектроПласт» предлагает заключение долгосрочных отношений при поставках импортных электронных компонентов на взаимовыгодных условиях!

Наши преимущества:

- Оперативные поставки широкого спектра электронных компонентов отечественного и импортного производства напрямую от производителей и с крупнейших мировых складов;
- Поставка более 17-ти миллионов наименований электронных компонентов;
- Поставка сложных, дефицитных, либо снятых с производства позиций;
- Оперативные сроки поставки под заказ (от 5 рабочих дней);
- Экспресс доставка в любую точку России;
- Техническая поддержка проекта, помощь в подборе аналогов, поставка прототипов;
- Система менеджмента качества сертифицирована по Международному стандарту ISO 9001;
- Лицензия ФСБ на осуществление работ с использованием сведений, составляющих государственную тайну;
- Поставка специализированных компонентов (Xilinx, Altera, Analog Devices, Intersil, Interpoint, Microsemi, Aeroflex, Peregrine, Syfer, Eurofarad, Texas Instrument, Miteq, Cobham, E2V, MA-COM, Hittite, Mini-Circuits, General Dynamics и др.);

Помимо этого, одним из направлений компании «ЭлектроПласт» является направление «Источники питания». Мы предлагаем Вам помощь Конструкторского отдела:

- Подбор оптимального решения, техническое обоснование при выборе компонента;
- Подбор аналогов;
- Консультации по применению компонента;
- Поставка образцов и прототипов;
- Техническая поддержка проекта;
- Защита от снятия компонента с производства.



#### Как с нами связаться

**Телефон:** 8 (812) 309 58 32 (многоканальный)

**Факс:** 8 (812) 320-02-42

**Электронная почта:** [org@eplast1.ru](mailto:org@eplast1.ru)

**Адрес:** 198099, г. Санкт-Петербург, ул. Калинина, дом 2, корпус 4, литера А.