

# Model 358P/L

## Advanced PLL LVPECL or LVDS VCXO



Part Dimensions:  
5.0 x 3.2 x 1.3mm • 58.1mg

### Features

- Ceramic Surface Mount Package
- Low Phase Jitter Performance, 500fs Typical
- Advanced PLL Design w/ Low Fundamental Crystal
- Frequency Range 10MHz – 800MHz \*
- +2.5V or +3.3V Operation
- Output Enable Standard
- Tape and Reel Packaging, EIA-418

### Applications

- Broadcast Video
- Storage Area Networking
- Broadband Access
- Phase-Locked Loop
- Networking Equipment
- Ethernet/GbE/SyncE
- Fiber Channel
- Test and Measurement

#### Standard Frequencies

- 25.00MHz	- 122.88MHz	- 200.00MHz
- 50.00MHz	- 125.00MHz	- 250.00MHz
- 74.25MHz	- 148.50MHz	- 300.00MHz
- 77.76MHz	- 155.52MHz	- 312.50MHz
- 100.00MHz	- 156.25MHz	

\* See Page 11 for additional developed frequencies.  
Check with factory for availability of frequencies not listed.

### Description

CTS Model 358P/L is a low cost, high performance PLL voltage controlled oscillator supporting differential LVPECL or LVDS outputs. Employing the latest IC technology, M358P/L has excellent stability and low phase jitter performance.

### Ordering Information

Model	Output Type	Frequency Code [MHz]	Absolute Pull Range	Frequency Stability	Temperature Range	Supply Voltage	Packaging
358	P	XXX or XXXX	B	3	I	3	T
	Code    Output		Code    APR		Code    Temp. Range		Code    Packing
	P        LVPECL		B        ±50ppm		C        -20°C to +70°C		T        1k pcs./reel
	L        LVDS				I        -40°C to +85°C		
		Code    Frequency		Code    Stability		Code    Voltage	
		Product Frequency Code <sup>1</sup>		5        ±25ppm <sup>2</sup>		2        +2.5Vdc	
				4        ±30ppm		3        +3.3Vdc	
				3        ±50ppm			

Notes:

- 1] Refer to document 016-1454-0, Frequency Code Tables.  
3-digits for frequencies <100MHz, 4-digits for frequencies 100MHz or greater.
- 2] Check factory availability when paired with "I" temperature code.

**Not all performance combinations and frequencies may be available.  
Contact your local CTS Representative or CTS Customer Service for availability.**

This product is specified for use only in standard commercial applications. Supplier disclaims all express and implied warranties and liability in connection with any use of this product in any non-commercial applications or in any application that may expose the product to conditions that are outside of the tolerances provided in its specification.



## Electrical Specifications

### Operating Conditions

PARAMETER	SYMBOL	CONDITIONS	MIN	TYP	MAX	UNIT
Maximum Supply Voltage	$V_{CC}$	-	-0.5	-	4.0	V
Maximum Control Voltage	$V_C$	$V_{CC} = +2.5V$	-0.5	-	3.0	V
		$V_{CC} = +3.3V$	-0.5	-	3.8	V
Supply Voltage	$V_{CC}$	$\pm 5\%$	2.375	2.5	2.625	V
			3.135	3.3	3.465	
Supply Current						
LVPECL	$I_{CC}$	Maximum Load	-	54	88	mA
LVDS		Maximum Current Value @ +3.3V	-	45	65	
Operating Temperature	$T_A$	-	-20	+25	+70	°C
			-40		+85	
Storage Temperature	$T_{STG}$	-	-55	-	+125	°C

### Frequency Stability

PARAMETER	SYMBOL	CONDITIONS	MIN	TYP	MAX	UNIT
Frequency Range	$f_O$	-		10 - 800		MHz
Frequency Stability [Note 1]	$\Delta f/f_O$	-		25, 30 or 50		$\pm$ ppm
Absolute Pull Range [Note 2]	APR	-	50	-	-	$\pm$ ppm
Aging	$\Delta f/f_{25}$	First Year @ +25°C, nominal $V_{CC}$	-3	-	3	ppm

1.] Inclusive of initial tolerance at time of shipment, changes in supply voltage, load, temperature and 1st year aging.

2.] Minimum guaranteed frequency shift from  $f_O$  over variations in temperature, aging, power supply and load.

### Output Parameters

PARAMETER	SYMBOL	CONDITIONS	MIN	TYP	MAX	UNIT
Output Type	-	-		LVPECL		-
Output Load	$R_L$	Terminated to $V_{CC} - 2.0V$	-	50	-	Ohms
Output Voltage Levels	$V_{OH}$	PECL Load	$V_{CC} - 1.03$	-	$V_{CC} - 0.60$	V
	$V_{OL}$		$V_{CC} - 1.85$	-	$V_{CC} - 1.60$	
Output Duty Cycle	SYM	@ $V_{CC} - 1.3V$	45	-	55	%
Rise and Fall Time	$T_R, T_F$	@ 20%/80% Levels, $R_L = 50$ Ohms	-	0.25	0.70	ns
Output Type	-	-		LVDS		-
Output Load	$R_L$	Between Outputs	-	100	-	Ohms
Output Voltage Levels	$V_{OH}$	LVDS Load	-	1.43	1.60	V
	$V_{OL}$		0.90	1.10	-	
Output Duty Cycle	SYM	@ 1.25V	45	-	55	%
Differential Output Voltage	$V_{OD}$	$R_L = 100$ Ohms	175	330	454	mV
Offset Voltage	$V_{OS}$	LVDS Load	1.20	1.25	1.30	V
Rise and Fall Time	$T_R, T_F$	@ 20%/80% Levels, $R_L = 100$ Ohms	-	0.4	0.7	ns



## Electrical Specifications

### Output Parameters

PARAMETER	SYMBOL	CONDITIONS	MIN	TYP	MAX	UNIT
Start Up Time	$T_S$	Application of $V_{CC}$	-	3	5	ms
<b>Enable Function [Tri-State]</b>						
Enable Input Voltage	$V_{IH}$	Pin 1 Logic '1', Output Enabled	$0.7V_{CC}$	-	-	V
Disable Input Voltage	$V_{IL}$	Pin 1 Logic '0', Output Disabled	-	-	$0.3V_{CC}$	V
Disable Current	$I_{IL}$	Pin 1 Logic '0', Output Disabled	-	16	22	mA
Enable Time	$T_{PLZ}$	Pin 1 Logic '1', Output Enabled	-	-	200	ns
Phase Jitter, RMS	$t_{jrms}$	Bandwidth 12 kHz - 20 MHz	-	500	<1000	fs
Period Jitter, RMS	$p_{jrms}$	-	-	2.5	-	ps
Period Jitter, pk-pk	$p_{jpk-pk}$	-	-	25	-	ps

### Control Voltage

PARAMETER	SYMBOL	CONDITIONS	MIN	TYP	MAX	UNIT
Control Voltage	$V_C$	$V_{CC} = 2.5V$	0.2	1.25	2.3	V
		$V_{CC} = 3.3V$	0.3	1.65	3.0	
Frequency Deviation	$\Delta f/f_0$	$V_C = 0.2V$	-	-60 to -180	-	ppm
		$V_C = 2.3V$	-	60 to 180	-	
		$V_C = 0.3V$	-	-60 to -180	-	ppm
		$V_C = 3.0V$	-	60 to 180	-	
Linearity	L	Best Straight Line Fit	-	-	$\pm 15$	%
Gain Transfer	$K_V$	Pull Sensitivity; @ +1.25V, +25°C Pull Sensitivity; @ +1.65V, +25°C	-	80	260	ppm/V
Input Impedance	$Z_{Vc}$	-	1	-	-	MOhms
Modulation Roll-off	-	@ -3dB	10	-	-	kHz
Transfer Function	-	-	-	Positive	-	-

### Enable Truth Table

Pin 2	Pin 4 & Pin 5
Logic '1'	Output
Open	Output
Logic '0'	High Imp.

## Electrical Specifications

Test Circuit  
LVPECL

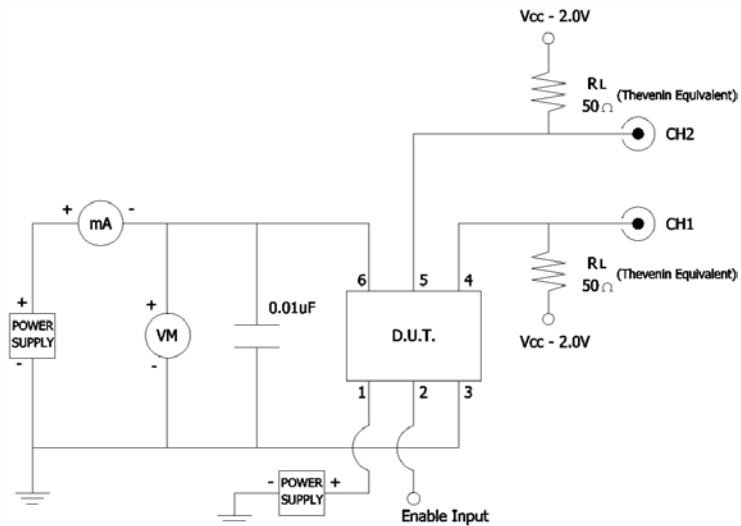

LVDS



## Output Waveform

LVPECL or LVDS

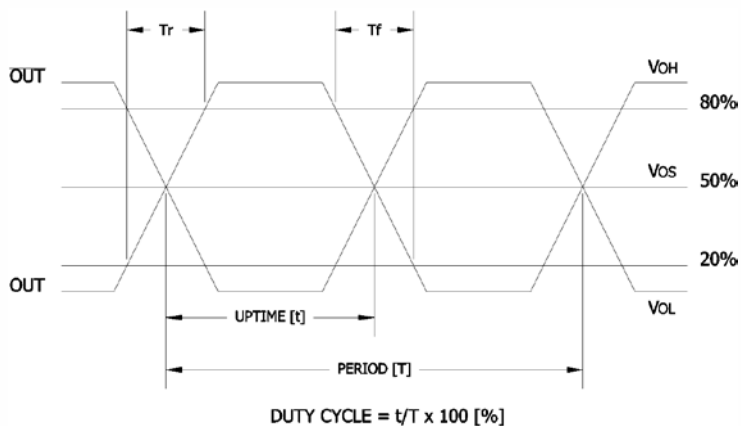

## Electrical Specifications

### Performance Data

#### Phase Noise [typical]

19.44MHz, LVDS,  $V_{CC} = +3.3V$ ,  $V_C = +1.65V$ ,  $T_A = +25^\circ C$

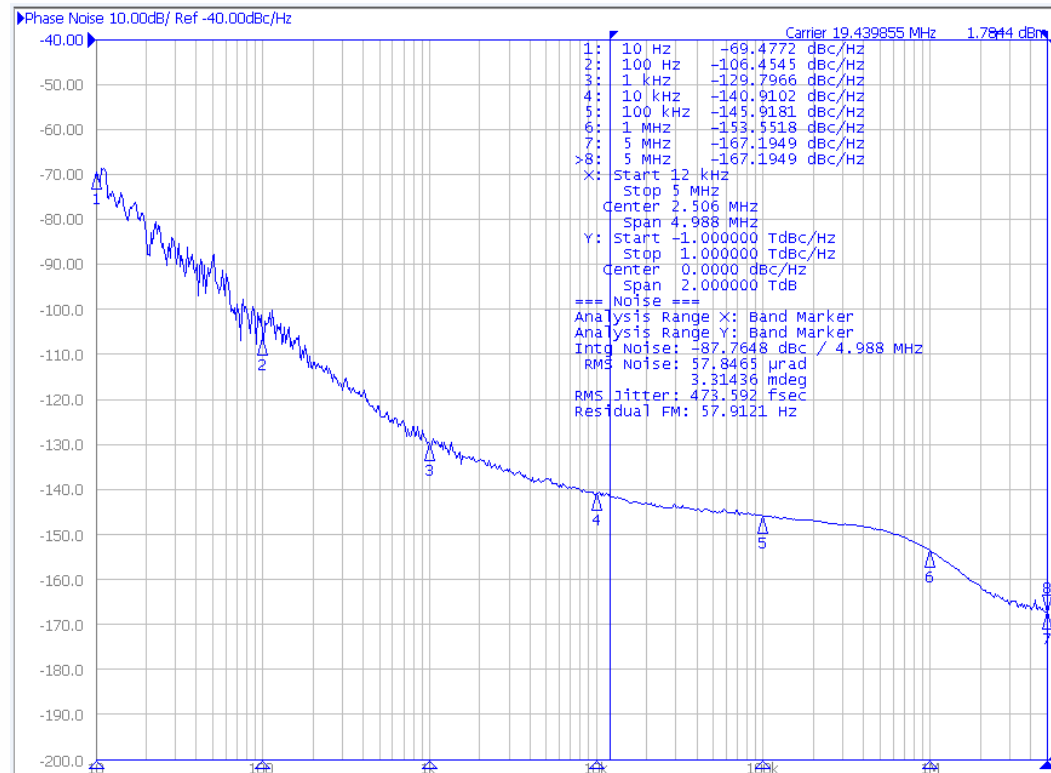

#### Phase Noise Tabulated

19.44MHz, LVDS,  $V_{CC} = +3.3V$ ,  $V_C = +1.65V$ ,  $T_A = +25^\circ C$

PARAMETER	SYMBOL	CONDITIONS	TYP	UNIT
<b>LVDS @ 19.44MHz</b>				
Phase Noise		Single Side Band		
		@ 10Hz	-69.4772	
		@ 100Hz	-106.4545	
		@ 1kHz	-129.7966	
	-	@ 10kHz	-140.9102	dBc/Hz
		@ 100kHz	-145.9181	
		@ 1MHz	-153.5518	
		@ 5MHz	-167.1949	
		@ 5MHz	-167.1949	
Phase Jitter, RMS	tj <sub>rms</sub>	Integration Bandwidth 12kHz - 5MHz	473.5920	fs



## Electrical Specifications

### Performance Data

#### Phase Noise [typical]

100MHz, LVPECL,  $V_{CC} = +3.3V$ ,  $V_C = +1.65V$ ,  $T_A = +25^\circ C$



#### Phase Noise Tabulated

100MHz, LVPECL,  $V_{CC} = +3.3V$ ,  $V_C = +1.65V$ ,  $T_A = +25^\circ C$

PARAMETER	SYMBOL	CONDITIONS	TYP	UNIT
<b>LVPECL @ 100MHz</b>				
<b>Phase Noise</b>		Single Side Band		
		@ 10Hz	-60.0468	
		@ 100Hz	-87.7044	
		@ 1kHz	-114.7894	
	-	@ 10kHz	-125.5298	dBc/Hz
		@ 100kHz	-129.3706	
		@ 1MHz	-140.0562	
		@ 10MHz	-155.0085	
	@ 20MHz	-155.3269		
<b>Phase Jitter, RMS</b>	tj <sub>rms</sub>	Integration Bandwidth 12kHz - 20MHz	580.0190	fs



### Electrical Specifications

#### Performance Data

#### Phase Noise [typical]

155.52MHz, LVPECL, V<sub>CC</sub> = +3.3V, V<sub>C</sub> = +1.65V, T<sub>A</sub> = +25°C

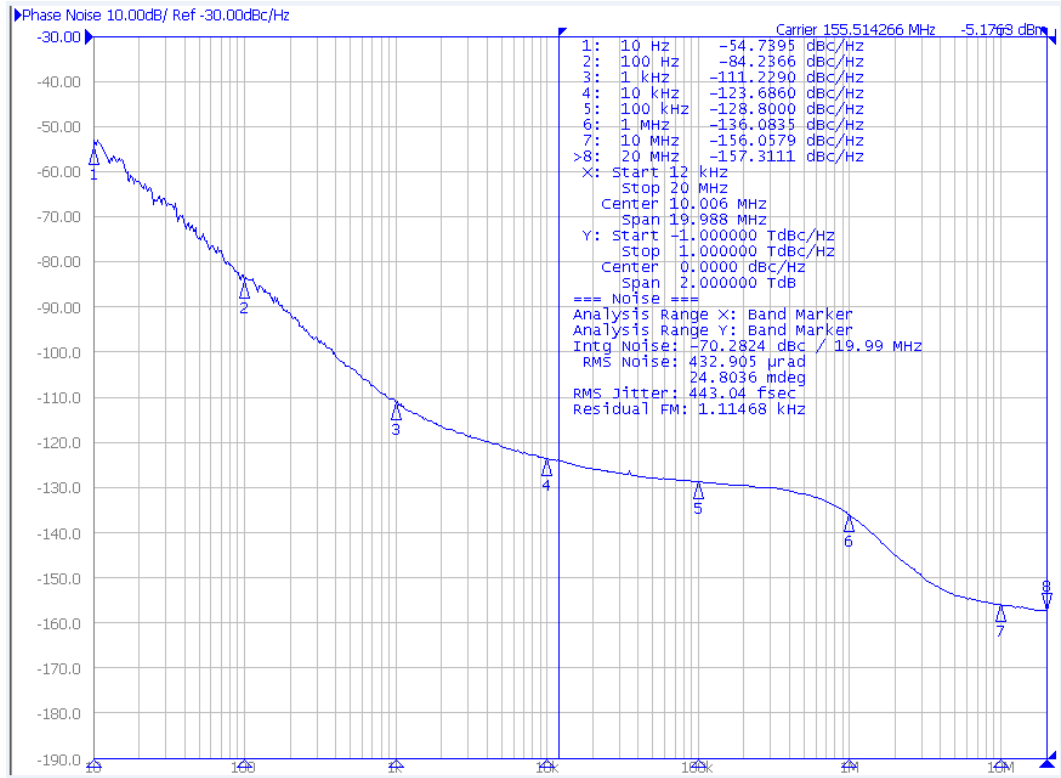

#### Phase Noise Tabulated

155.52MHz, LVPECL, V<sub>CC</sub> = +3.3V, V<sub>C</sub> = +1.65V, T<sub>A</sub> = +25°C

PARAMETER	SYMBOL	CONDITIONS	TYP	UNIT
<b>LVPECL @ 155.52MHz</b>				
<b>Phase Noise</b>		Single Side Band		
		@ 10Hz	-54.7395	
		@ 100Hz	-84.2366	
		@ 1kHz	-111.2290	
	-	@ 10kHz	-123.6860	dBc/Hz
		@ 100kHz	-128.8000	
		@ 1MHz	-136.0835	
		@ 10MHz	-156.0579	
		@ 20MHz	-157.3111	
<b>Phase Jitter, RMS</b>	tj <sub>rms</sub>	Integration Bandwidth 12kHz - 20MHz	443.0400	fs

## Mechanical Specifications

### Package Drawing

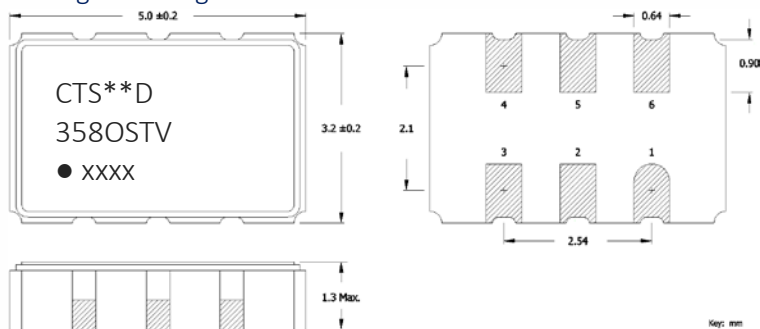

### Marking Information

- \*\* – Manufacturing Site Code.
- D – Date Code. See Table I for codes.
- O – Output Type; P = LVPECL, L = LVDS.
- ST – Frequency Stability/Temperature Code. [Refer to Ordering Information]
- V – Voltage Code; 3 = 3.3V, 2 = 2.5V.
- xxxx – Frequency Code.  
3-digits, frequencies below 100MHz  
4-digits, frequencies 100MHz or greater  
[See document 016-1454-0, Frequency Code Tables.]

### Recommended Pad Layout



### Notes

- JEDEC termination code (e4). Barrier-plating is nickel [Ni] with gold [Au] flash plate.
- Reflow conditions per JEDEC J-STD-020; +260°C maximum, 20 seconds.
- MSL = 1.

### Pin Assignments

Pin	Symbol	Function
1	V <sub>C</sub>	Voltage Control
2	EOH	Enable [tri-state]
3	GND	Circuit & Package Ground
4	Output	RF Output
5	Output	Complimentary RF Output
6	V <sub>CC</sub>	Supply Voltage

Table I - Date Code

YEAR		MONTH														
		JAN	FEB	MAR	APR	MAY	JUN	JUL	AUG	SEP	OCT	NOV	DEC			
2001	2005	2009	2013	2017	A	B	C	D	E	F	G	H	J	K	L	M
2002	2006	2010	2014	2018	N	P	Q	R	S	T	U	V	W	X	Y	Z
2003	2007	2011	2015	2019	a	b	c	d	e	f	g	h	j	k	l	m
2004	2008	2012	2016	2020	n	p	q	r	s	t	u	v	w	x	y	z



### Packaging - Tape and Reel

Tape Drawing – 12mm Width

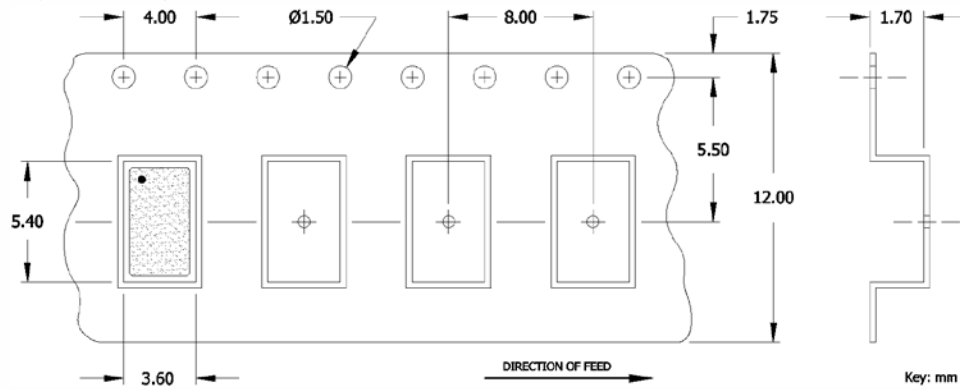

Tape Drawing – 16mm Width

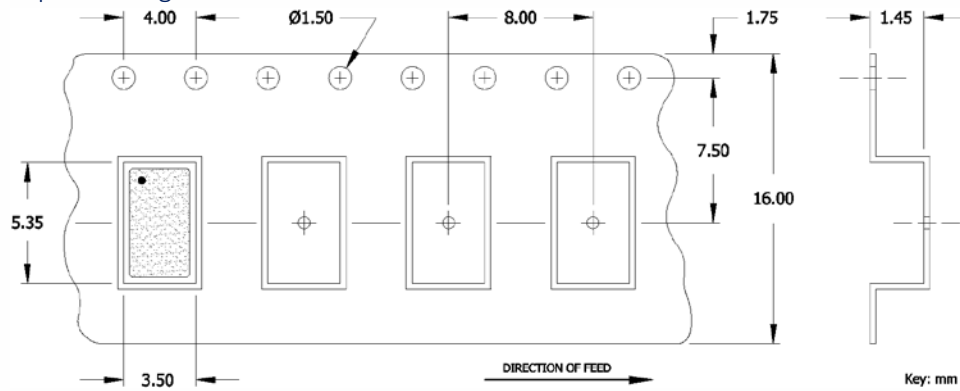

### Packaging - Tape and Reel

Reel Drawing – 12mm Width



Reel Drawing – 16mm Width



#### Notes

1. Device quantity is 1k pieces per 180mm reel.
2. Complete CTS part number, frequency value and date code information must appear on reel and carton labels.



## Addendum

### Additional Developed Frequencies – MHz

FREQUENCY	FREQUENCY CODE	FREQUENCY	FREQUENCY CODE	FREQUENCY	FREQUENCY CODE	FREQUENCY	FREQUENCY CODE
27.000000	270	74.175800	74A	144.500000	1445	322.265625	322A
38.840000	38D	76.800000	768	148.351648	148B	349.400000	3494
38.880000	388	86.700000	867	150.000000	1500	400.000000	4000
43.350000	433	87.351542	873	153.600000	1536	448.000000	4480
45.000000	450	92.160000	921	156.253906	156A	622.080000	6220
54.000000	540	106.250000	1062	160.000000	1600		
62.500000	625	132.000000	1320	184.320000	1843		

### Frequency Codes for Cover Page Table – MHz

FREQUENCY	FREQUENCY CODE	FREQUENCY	FREQUENCY CODE	FREQUENCY	FREQUENCY CODE
25.000000	250	122.880000	1228	200.000000	2000
50.000000	500	125.000000	1250	250.000000	2500
74.250000	742	148.500000	1485	300.000000	3000
77.760000	777	155.520000	1555	312.500000	3125
100.000000	1000	156.250000	1562		



Компания «ЭлектроПласт» предлагает заключение долгосрочных отношений при поставках импортных электронных компонентов на взаимовыгодных условиях!

Наши преимущества:

- Оперативные поставки широкого спектра электронных компонентов отечественного и импортного производства напрямую от производителей и с крупнейших мировых складов;
- Поставка более 17-ти миллионов наименований электронных компонентов;
- Поставка сложных, дефицитных, либо снятых с производства позиций;
- Оперативные сроки поставки под заказ (от 5 рабочих дней);
- Экспресс доставка в любую точку России;
- Техническая поддержка проекта, помощь в подборе аналогов, поставка прототипов;
- Система менеджмента качества сертифицирована по Международному стандарту ISO 9001;
- Лицензия ФСБ на осуществление работ с использованием сведений, составляющих государственную тайну;
- Поставка специализированных компонентов (Xilinx, Altera, Analog Devices, Intersil, Interpoint, Microsemi, Aeroflex, Peregrine, Syfer, Eurofarad, Texas Instrument, Miteq, Cobham, E2V, MA-COM, Hittite, Mini-Circuits, General Dynamics и др.);

Помимо этого, одним из направлений компании «ЭлектроПласт» является направление «Источники питания». Мы предлагаем Вам помощь Конструкторского отдела:

- Подбор оптимального решения, техническое обоснование при выборе компонента;
- Подбор аналогов;
- Консультации по применению компонента;
- Поставка образцов и прототипов;
- Техническая поддержка проекта;
- Защита от снятия компонента с производства.



#### Как с нами связаться

**Телефон:** 8 (812) 309 58 32 (многоканальный)

**Факс:** 8 (812) 320-02-42

**Электронная почта:** [org@eplast1.ru](mailto:org@eplast1.ru)

**Адрес:** 198099, г. Санкт-Петербург, ул. Калинина, дом 2, корпус 4, литера А.