

# H8BM-R

## Nine Built-in Counters/Timers to Measure Equipment Operating Cycles and Times and Forecast Maintenance Timing



- Provides up to nine counters or accumulative timers. (Counter and timer functions can be used at the same time.)
- Individual forecast outputs to indicate maintenance timing.
- Pre-forecast display and machine stoppage output provided.
- IP54 oil-proof type at setting area for resistance to oil and water.
- Separate digit keys to easily change settings.
- Compact, short-body: 72 × 72 × 79 mm (DIN).
- Key protection function prevents incorrect operation.
- Multiple outputs: NPN/PNP.
- Directly connectable to 2-wire DC sensors.
- Complies with UL and CSA.



For the most recent information on models that have been certified for safety standards, refer to your OMRON website.

**The H8BM-R can be used as a multi-stage preset counter.**

Refer to *Safety Precautions* on page 7.

## Ordering Information

### Multi-maintenance Counter/Timer

| Preset stage    | Nameplate lettering | Model         |
|-----------------|---------------------|---------------|
| 3-stage setting | Japanese            | H8BM-RA DC24  |
|                 | English             | H8BM-RB DC24  |
| 1-stage setting | Japanese            | H8BM-RAD DC24 |
|                 | English             | H8BM-RBD DC24 |

### Accessories (Order Separately)

| Name                                | Model    |
|-------------------------------------|----------|
| Hard Protective Cover (See note 1.) | Y92A-72C |
| Rubber Packing (See note 1.)        | Y92S-25  |
| Short-circuit plate (See note 2.)   | Y92S-26  |

Note 1. A Hard Protective Cover and Rubber Packing are supplied with the Counter.

2. The H8BM-R□ is provided with short input as standard to achieve a Multi-stage Counter without having to use a short-circuit plate and external wiring.

### Specifications

| Item                           | Model | H8BM-RA/RB  | H8BM-RAD/RBD  |
|--------------------------------|-------|---|---|
| <b>Classification</b>          |       | 3-stage setting   | 1-stage setting   |
| <b>Mounting method</b>         |       | Flush mounting  |   |
| <b>External connections</b>    |       | Screw terminals   |   |
| <b>Degree of protection</b>    |       | IP54 oil-proof type (case front)  |   |
| <b>Input mode</b>              |       | Up  |   |
| <b>Output mode</b>             |       | F mode (Operation continues even when setting is reached.)  |   |
| <b>Reset system</b>            |       | External, manual resets   |   |
| <b>Timer operation</b>         |       | Yes   |   |
| <b>Input method</b>            |       | Voltage inputs: High and low signal voltages (count, reset, short, counter No. selection, I/O inhibit)  |   |
| <b>Control output</b>          |       | No-contact outputs: RUN, forecast, machine stoppage   | No-contact outputs: RUN, forecast                                       |
| <b>Display</b>                 |       | Count, preset value, counter number, and error codes displayed on 7-segment LCD<br>Mode, reset, I/O inhibit, re-monitor modes, and key protection displayed on LCD characters<br>Output indication on LCD characters and LEDs |   |
| <b>LCD with backlight</b>      |       | Yes   |   |
| <b>Built-in counter number</b> |       | 9 (counters 1 to 9) (See note 1.)   |   |
| <b>Preset stage</b>            |       | 3-stage (See note 2.)   | 1-stage (See note 3.)   |
| <b>Digits</b>                  |       | Forecast value: 6 digits (999999)<br>Pre-forecast value: -5 digits (See note 4.)<br>Machine stoppage: +5 digits (See note 5.)   | Forecast value: 6 digits (999999)                                       |
| <b>Time ranges</b>             |       | Forecast value: 99999.9 h (0.1 h or longer)/<br>99999.9 s (0.1 s or longer)<br>Pre-forecast value: -9999.9 h/-9999.9 s (See note 4.)<br>Machine stoppage: +9999.9 h/+9999.9 s (See note 5.)                                   | Forecast value: 99999.9 h (0.1 h or longer)/99999.9 s (0.1 s or longer) |
| <b>Memory backup</b>           |       | EEPROM (Data can be written 100,000 times.), Backup time for power interruption: Approx. 10 years   |   |

Note 1. Each channel operates on a separate I/O.

2. The 3-stage are pre-forecast, forecast, and machine stoppage.

Pre-forecast:

Displayed only on LCD (no external output is provided).

Forecast: Displayed on LCD and LED and output (output for each counter).

Machine stoppage:

Displayed on LCD and LED and output (output when the count value of one or more of counters 1 to 9 has reached its machine stoppage value).

3. This Counter operates on the forecast value only.

4. The pre-forecast value is set as a negative offset in respect to the forecast value.

5. The machine stoppage value is set as a positive offset in respect to the forecast value.

## Specifications

### ■ Ratings

|   |   |
|---|---|
| <b>Rated supply voltage</b>   | 24 VDC  |
| <b>Operating voltage range</b>  | 85% to 110% of rated supply voltage (See note 1.)   |
| <b>Power consumption</b>  | Approx. 1.7 W (at 26.4 VDC)   |
| <b>Max. counting speed</b>  | 30 Hz for count inputs 1 to 7,<br>Switchable between 30 Hz and 500 Hz for count inputs 8 and 9  |
| <b>Min. counting input signal width</b>                                     | Count inputs 1 to 7: 16.7 ms (ON:OFF = 1:1)<br>Count inputs 8 and 9: 16.7 ms/1 ms selectable (ON:OFF = 1:1)<br>Reset input: 100 ms max.<br>Short input: 75 ms max.<br>Counter number selection input: 30 ms max.<br>I/O inhibit input: 16.7 ms max. |
| <b>One-shot time</b>  | 20 ms (See note 2.)   |
| <b>Count, reset, short, counter number selection, and I/O inhibit input</b> | Voltage input<br>High level: 16 to 26.4 VDC<br>Low level: 0 to 3 VDC<br>(input resistance: approx. 2.2 kΩ)  |
| <b>Control output</b>   | Open-collector output: 100 mA max. at 30 VDC max.   |
| <b>Surrounding air temperature</b>  | -10 to +55°C (with no icing or condensation)  |
| <b>Ambient storage temperature</b>  | -25 to +65°C (with no icing or condensation)  |
| <b>Ambient operating humidity</b>   | 25% to 85%  |
| <b>Case color</b>   | Dark gray (Munsell 5Y3/1)   |

Note 1. Ripple content: 20% max.

2. This signal is output as a carry signal when the Counter is used as a total counter.

### ■ Applicable Standards

|                         |  |  |
|-------------------------|--|--|
| <b>Safety standards</b> | UL508 (See note 1.)/CSA C22.2 No.14<br>EN61326 |  |
| <b>EMC</b>              | (EMI)  | EN61326-1 (See note 2.)  |
|                         | Emission Enclosure:                            | EN61326-1 (EN55011 Group 1 Class A)  |
|                         | Emission AC Mains:                             | EN61326-1 (EN55011 Group 1 Class A)  |
|                         | (EMS)  | EN61326-1 (See note 2.)  |
|                         | Immunity ESD:                                  | EN61326-1 (EN61000-4-2): Contact discharge: 4 kV, air discharge: 8 kV  |
|                         | Radiated electromagnetic field immunity:       | EN61326-1 (EN61000-4-3): 10 V/m (Amplitude modulated, 80 MHz to 1 GHz, 1,400 to 2,000 MHz)<br>10 V/m (Pulse-modulated, 900 MHz ±5 MHz) |
|                         | Immunity Burst:                                | EN61326-1 (EN61000-4-4): 2 kV power-line, 1 kV I/O signal-line   |
|                         | Immunity Surge:                                | EN61326-1 (EN61000-4-5): 1 kV line to line (power line), 2 kV line to ground (power line)  |
|                         | Immunity Conducted Disturbance:                | EN61326-1 (EN61000-4-6): 10 V (0.15 to 80 MHz)   |

Note 1. Attach a waterproof cover of Y92A-72N.

2. Industrial electromagnetic environment (EN/IEC 61326-1 Table 2)

### ■ Characteristics

|                                    |  |
|------------------------------------|--|
| <b>Insulation resistance</b>       | 100 MΩ min. (at 500 VDC) (between current-carrying terminals and exposed non-current-carrying metal parts)   |
| <b>Dielectric strength voltage</b> | 1,000 VAC, 50/60 Hz for 1 min (between current-carrying terminals and exposed non-current-carrying metal parts)                                    |
| <b>Impulse withstand voltage</b>   | 1 kV (between power terminals)<br>1.5 kV (between current-carrying terminals and exposed non-current-carrying metal parts)                         |
| <b>Noise immunity</b>              | ±480 kV (between power terminals) and ±480 V (between input terminals), square-wave noise by noise simulator (pulse width: 100 ns/1 μs, 1-ns rise) |
| <b>Static immunity</b>             | Malfuction: 8 kV; destruction: 15 kV   |
| <b>Vibration resistance</b>        | <b>Destruction</b><br>10 to 55 Hz with 0.75-mm single amplitude, 2 hours each in three directions  |
|                                    | <b>Malfuction</b><br>10 to 55 Hz with 0.5-mm single amplitude, 10 minutes each in three directions   |
| <b>Shock resistance</b>            | <b>Destruction</b><br>300 m/s <sup>2</sup> 3 times each in 6 directions  |
|                                    | <b>Malfuction</b><br>200 m/s <sup>2</sup> 3 times each in 6 directions   |
| <b>Weight</b>                      | Approx. 250 g (Counter only)   |

## Connections

### Internal Connections

#### H8BM-R

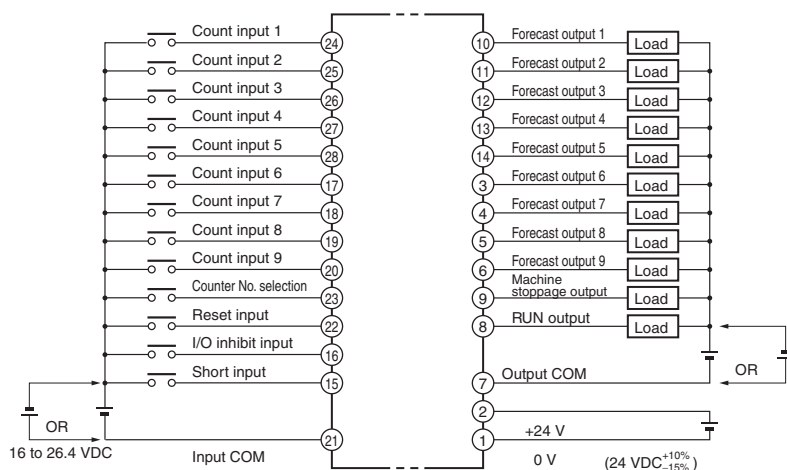

|                           | RUN, machine stoppage, forecast 1 to 9 |
|---------------------------|--|
| <b>Output method</b>      | Open collector                         |
| <b>Switching capacity</b> | 30 VDC max., 100 mA max.               |
| <b>Residual voltage</b>   | 2 VDC max.                             |
| <b>Leakage current</b>    | 100 $\mu$ A max.                       |

- Note 1. When the load is short-circuited, the internal circuits may be damaged.  
 2. Connect a diode to suppress Counter surge when an inductive load is connected.

- Note 1. H8BM-RAD/-RBD outputs the forecast and machine stoppage values simultaneously.  
 2. The I/O terminals are used for both PNP and NPN. There is no polarity.

### I/O Functions

#### Inputs

|                              |   |
|------------------------------|---|
| <b>Count 9 inputs</b>        | <ul style="list-style-type: none"> <li>Input count values.</li> <li>Used as time count input signal when timer is used.</li> <li>Max. counting speed receivable: Count inputs 1 to 7: 30 Hz (Min. signal input width: 16.7 ms), Count inputs 8 and 9: 30 Hz/500 Hz (Min. signal input width: 16.7 ms/1 ms)</li> </ul>   |
| <b>Reset 1 input</b>         | <ul style="list-style-type: none"> <li>Resets count/time value of a displayed Counter No.</li> <li>Counter under reset does not operate as its output is turned OFF.</li> <li>Reset signal input received while re-monitor function is ON restores reset count/time value of the specified counter.</li> <li>While reset signal is ON, RESET indicator lights.</li> </ul> |
| <b>Short</b>                 | <ul style="list-style-type: none"> <li>When the short input is ON, an input is also received for one of the count inputs 2 to 9 when an input is received for count input 1. The H8BM can thus be used as a multi-stage preset counter without performing external short-circuit wiring.</li> </ul>   |
| <b>Counter No. selection</b> | <ul style="list-style-type: none"> <li>Specifies counter whose count/time value is to be displayed.</li> </ul>  |
| <b>I/O inhibit</b>           | <ul style="list-style-type: none"> <li>Inhibits count inputs of all counters.</li> <li>Turns OFF all forecast outputs, RUN outputs, and machine stoppage outputs.</li> <li>While I/O inhibit signal is ON, INHB indicator lights.</li> </ul>  |

#### Outputs

|   |   |
|---|---|
| <b>Forecast 9 outputs</b>                 | <ul style="list-style-type: none"> <li>Each of these outputs turns ON when its forecast value has been reached.</li> <li>When a total counter is used, output one-shot signals as carry signals.</li> <li>Retain outputs until count values are reset.</li> </ul> |
| <b>RUN 1 output</b>                       | <ul style="list-style-type: none"> <li>Turns ON when Counter is operating normally.</li> </ul>  |
| <b>Machine stoppage 1 output (Common)</b> | <ul style="list-style-type: none"> <li>Turns ON when count value of one counter has reached set machine stoppage value.</li> <li>Retains output until count value is reset.</li> </ul>  |

Note: The input and output signals are enabled when power is applied to the Counter. During a power failure, the input signals are disabled, and the output signals are turned OFF.

## Terminal Arrangement

|    |    |    |    |    |    |    |
|----|----|----|----|----|----|----|
| 22 | 23 | 24 | 25 | 26 | 27 | 28 |
| 15 | 16 | 17 | 18 | 19 | 20 | 21 |
| 8  | 9  | 10 | 11 | 12 | 13 | 14 |
| 1  | 2  | 3  | 4  | 5  | 6  | 7  |

|                   |                         |                   |                   |                   |                   |                   |
|-------------------|-------------------------|-------------------|-------------------|-------------------|-------------------|-------------------|
| 22                | 23                      | 24                | 25                | 26                | 27                | 28                |
| Reset input       | Counter No. selection   | Count input 1     | Count input 2     | Count input 3     | Count input 4     | Count input 5     |
| 15                | 16                      | 17                | 18                | 19                | 20                | 21                |
| Short input       | I/O inhibit input       | Count input 6     | Count input 7     | Count input 8     | Count input 9     | Input COM         |
| 8                 | 9                       | 10                | 11                | 12                | 13                | 14                |
| RUN output        | Machine stoppage output | Forecast output 1 | Forecast output 2 | Forecast output 3 | Forecast output 4 | Forecast output 5 |
| 1                 | 2                       | 3                 | 4                 | 5                 | 6                 | 7                 |
| Power supply: 0 V | Power supply: 24 V      | Forecast output 6 | Forecast output 7 | Forecast output 8 | Forecast output 9 | Output COM        |

## I/O Connections

### Input Circuits

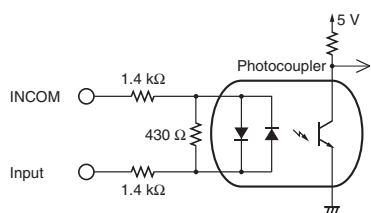

Note: Although the input terminals are electrically insulated from the internal circuit, do not conduct an insulation resistance test on these terminals.

### Output Circuits

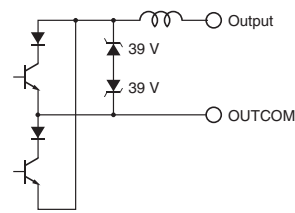

Note: Although the output terminals are electrically insulated from the internal circuit, do not conduct an insulation resistance test on these terminals.

### Example of Input Connections (Solid-state Switches)

#### Two-wire Sensors

The count input, counter number selection, reset input, I/O inhibit input, and short input signals are input when the two-wire Sensor turns ON.

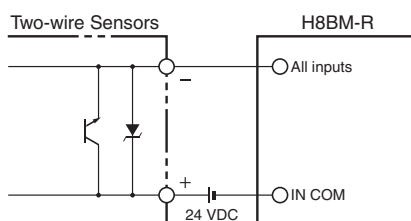
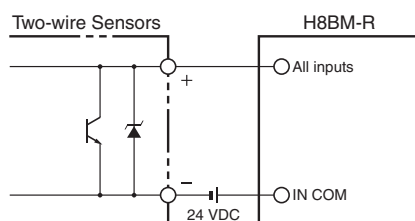

Note: Use the following two-wire Proximity Sensors:  
 (1) High-level: transistor ON  
 Switching capacity: 5 mA min. Residual voltage: 4 VDC max.  
 (2) Low-level: transistor OFF  
 Leakage current: 1.5 mA max.  
 (3) Operating voltage range: 20.4 to 26.4 VDC  
 We recommend using OMRON E2E-X□□-N Sensors.

#### Three-wire Sensors

##### • NPN Type

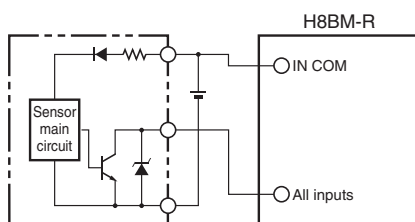

##### • PNP Type

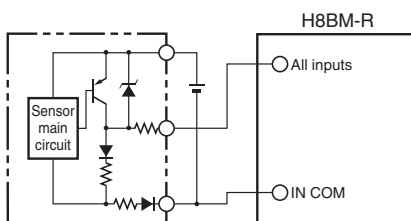
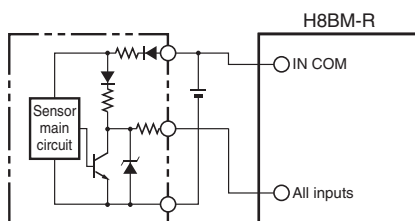
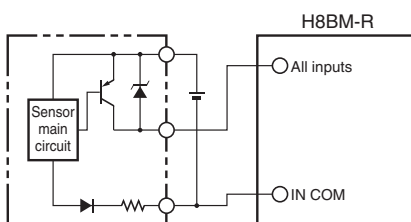

### Example of Input Connections (Contact Switches)

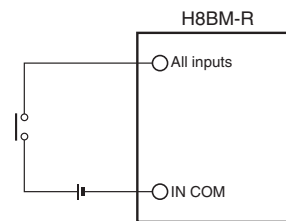
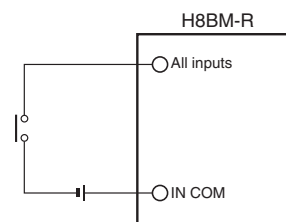

\*H: Contact ON.  
 \*Use a contact which can adequately switch 13 mA at 30 V.

## Operating Methods

### ■ Timing Charts

#### 1. Counter (3-stage Preset Operation)

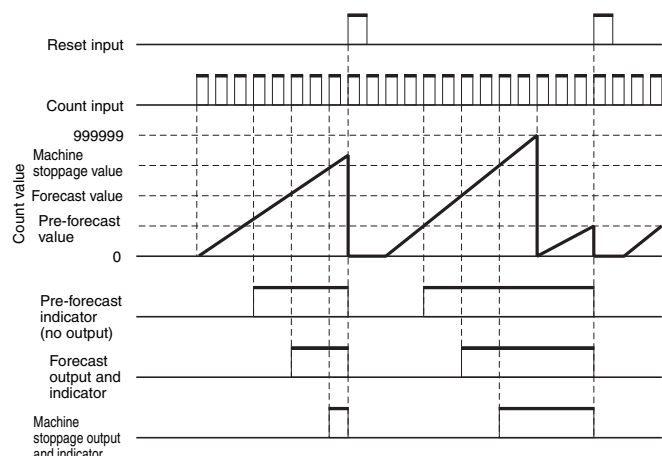

#### 2. Timer (3-stage Preset Operation)

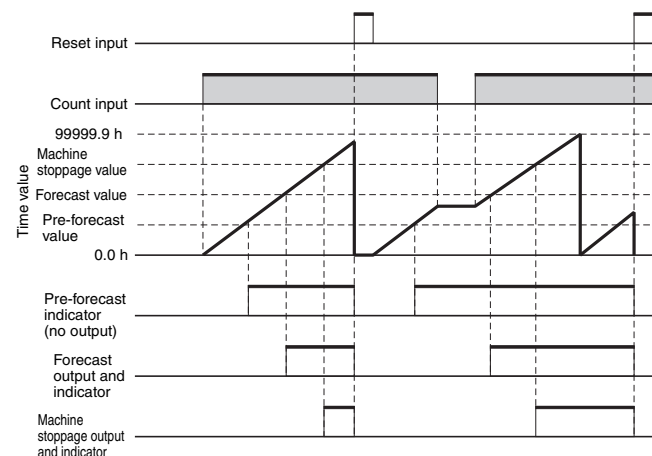

#### 3. Total Counter Operation

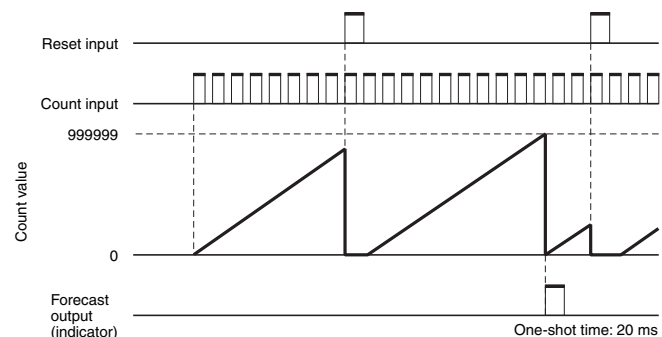

#### 4. Total Timer Operation

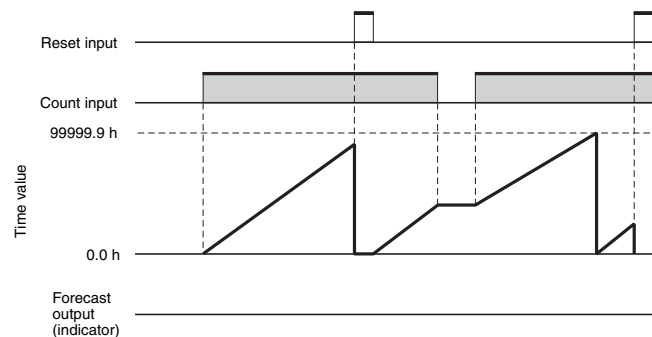

Note: The count will return to 0 when 999999 is exceeded.

When the power supply is turned OFF, the display and outputs will turn OFF, but the current count/time value will be stored in internal memory.

## Nomenclature

- Initial Setting Mode Indicator  
Indicates that the system is in the initial setting mode.
- I/O Inhibit Indicator  
Indicates that the I/O inhibit input signal is ON.
- Re-monitor Indicator  
Indicates that the system is in the re-monitor function operation.
- RESET Indicator  
Indicates that the system is resetting.
- Key Protection Indicator  
Indicates that operation of the keys on the front panel is disabled.
- Counter No. Indicator  
Indicates the number of the counter whose data is currently displayed.
- RESET Key  
Resets the count value and output signals.
- COUNTER No. Key  
Selects the counter in sequence each time this Selector is pressed:  
1→2→3→4→5→6→7→8→9  
(Any counter whose forecast value is set to 0 is skipped in RUN mode.)
- MODE Key  
Selects the mode in sequence each time this key is pressed:  
RUN → Forecast Value → Pre-forecast value → Machine stoppage value

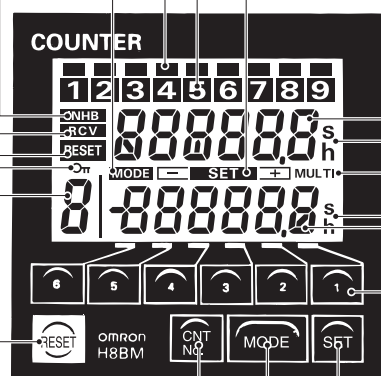

- The following indicators light to show that the count value has reached the preset value and that the output has turned ON.
- Control Output Indicator (Red LED):
    - Pre-forecast value: LCD lights
    - Forecast value: RED LED lights
    - Machine stoppage value: Indicator flashes between red and green and LCD output indicator flashes.
  - Control Output Indicator (LCD)
  - Set Mode Indicator
    - OFF RUN mode
    - SET Forecast value
    - SET Pre-forecast value
    - SET Machine stoppage value
  - Current Value (10-mm Height)  
Indicates the current count (current time in timer mode).
  - Time Range Indicator  
s: seconds, h: hours
  - Multiplication Counter Indicator  
Indicates that the system is in multiplication counter function operation.
  - Preset Value (7-mm Height)  
Indicates the forecast value during RUN operation. Indicates the set value in each setting mode.
  - Up Keys 1 to 6  
Each of these keys increments the preset value of the corresponding digit, each time it is pressed.  
0→1→2→3→4→5→6→7→8→9
  - SET Key  
Inputs the set or changed data.

Note: Models with only 1-stage setting (H8BM-RAD/RBD) are not provided with pre-forecast and machine stoppage output function; only the forecast output function is provided.

## Dimensions

### Counter

#### Counter

#### H8BM-R

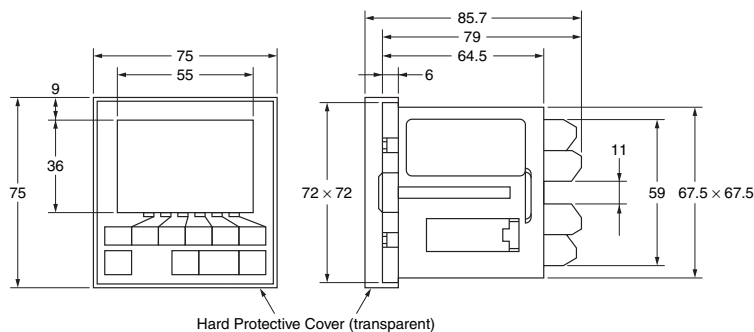

Hard Protective Cover (transparent)

### Installation

#### Installation Diagram

To mount the Counter, attach the two supplied brackets to the left and right sides of the Counter, and securely tighten the knurled screws on the brackets by hand, keeping the Counter balanced on the right and left. The performance may not be satisfactory if the screws are loose or excessively tightened. If the knurled screws are excessively tightened with pliers or other tool, damage may result.

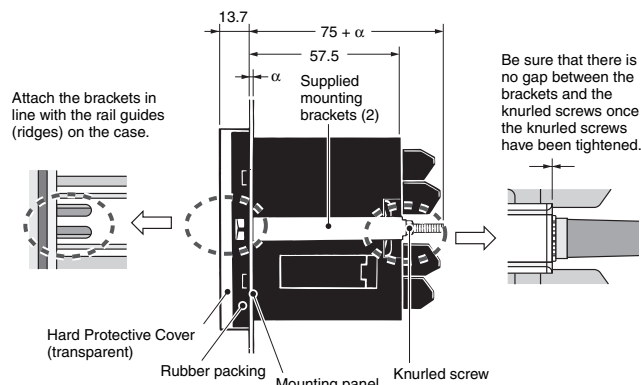

M 3x5 screws are used. Select solderless terminals referring to the figure below.



#### Panel Cutouts

The panel cutout is as shown below (according to DIN 43700). The mounting panel thickness must be 1 to 5 mm. Mount the Counter so that the ambient temperature will not exceed 55°C.

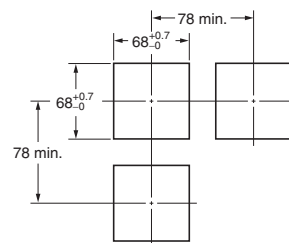

#### Spacing with Other Devices

Provide enough space around the Counter when mounting it to ensure a proper working space.

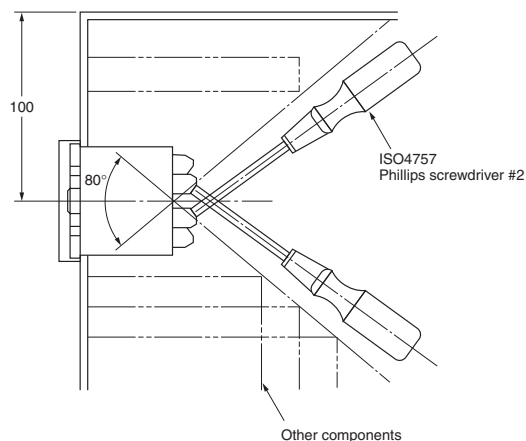

Other components

## Safety Precautions

Refer to *Safety Precautions for All Counters*.

### CAUTION

Fire may occasionally occur. Tighten terminal screws securely to a tightening torque of 0.5 to 0.6 N·m.



Minor electric shock, fire, or Product failure may occasionally occur. Do not disassemble, modify, or repair the Product or touch the interior of the Product.



Minor electric shock, fire, or Product failure may occasionally occur. Do not allow any pieces of metal or conductors or any clippings or cuttings resulting from installation work to enter the Product.



### Precautions for Safe Use

In order to ensure safe operation, be sure to observe the following points.

- (1) Store the Counter within the specified temperature range. If the Counter has been stored at a temperature under  $-10^{\circ}\text{C}$ , allow the Counter to stand at room temperature for at least 3 hours before using it.
- (2) Use the Counter within the ratings specified for ambient operating temperature and ambient operating humidity.
- (3) Do not operate the Counter in any of the following locations.
  - Locations subject to sudden or extreme changes in temperature.
  - Locations where high humidity may result in condensation.
- (4) Use the Counter within the specified ratings for vibration and shock.
- (5) Do not use the Counter in locations subject to excessive dust, corrosive gases, or direct sunlight.
- (6) When using the Counter in environments subject to large amounts of static electricity (e.g., pipes carrying molding materials, powders, or fluid materials), separate the Counter as far as possible from the sources of static electricity.
- (7) Use the Counter within the specified ratings for vibration, shock, water immersion, and exposure to oil.
- (8) Always use a thermo-switch on the load circuit when a heater is used.
- (9) Do not use organic solvents (such as paint thinner or benzene), strong alkalis, or strong acids because they will damage the external finish of the Counter.
- (10) Install a switch or circuit breaker that allows the operator to immediately turn OFF the power, and label it to clearly indicate its function.
- (11) Be sure that all terminals are wired correctly.
- (12) Do not connect more than two crimp terminals to the same terminal.
- (13) Use the specified wires for wiring.
 

Applicable Wires  
AWG22 to AWG14  
(cross-sectional area of 0.326 to 2.081 mm<sup>2</sup>)  
Solid or twisted wires of copper
- (14) Always maintain the load current within specifications.
- (15) Use a switch, relay, or other contact device to turn OFF the power supply instantaneously. Outputs may malfunction and memory errors may occur if the power supply voltage is decreased gradually.
- (16) Up to two wires of the same size and type can be inserted into a single terminal.
- (17) Separate the input devices, input wiring, and Counter as far as possible from sources of noise and power lines carrying noise.
- (18) The life of internal parts may be reduced if Counters are mounted in close proximity to each other.
- (19) Maintain voltage fluctuations in the power supply within the specified range.
- (20) Use a switch, relay, or other contacts so that the rated power supply voltage will be reached within 0.1 s. If the power supply voltage is not reached quickly enough, the power source may fail to reset or the outputs may fail to operate correctly.
- (21) Do not leave the Counter for long periods at a high temperature with output current in the ON state. Doing so may result in the premature deterioration of internal components (e.g., electrolytic capacitors).
- (22) Periodically inspect and replace the rubber packing. It may deteriorate, expand, shrink, or harden in some operation environments.
- (23) Check that the backlight, output indicators, and LCD are operating normally. Some operating environments may accelerate deterioration of the indicators, LCD, and resin components and cause display malfunctions. Periodically inspect and replace parts.
- (24) Be sure that the voltage applied is within the specified range; otherwise, the internal elements of the Counter may be damaged.

### Precautions for Correct Use

- (1) Be sure that the capacity of the power supply is sufficient. The Counter may not start due to the capacity of the power supply or the inrush current that may flow for an instant (approx. 1.6 A for 12 ms) when the Counter is turned ON.
- (2) The Power Supply, input, and output circuits are electrically isolated inside the Counter. When turning the power ON and OFF, input signal reception is sometimes possible, sometimes not possible, and sometimes unstable, as shown in the diagram below.

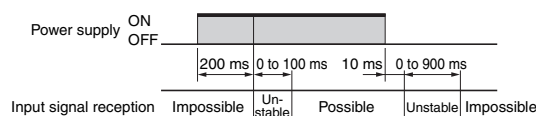

Turn on or off the operating power source all at once by using switch or relay contact.

- (3) EEPROM is used to back up the memory if the power fails. Data can be written to EEPROM 100,000 times. Data is written to the EEPROM when the settings are changed or deleted or the power is turned OFF.
- (4) The Counter uses a constant read-in system, so outputs will turn ON if the set values are changed during operation such that the set value is equal to or less than the count value.
- (5) Dispose of the Counter in accordance with all local industrial waste disposal procedures.
- (6) The water and oil resistance will be lost if the front sheet is peeled off or torn. Do not use the Counter if the front sheet is peeled or torn.

## Operation

### 1. DIP Switch Settings

Key protection and whether each counter operates as a counter or a timer are specified on a DIP switch provided on the side panel of the Counter. Open the cover of the switch compartment on the side of the Counter to access the DIP switch.

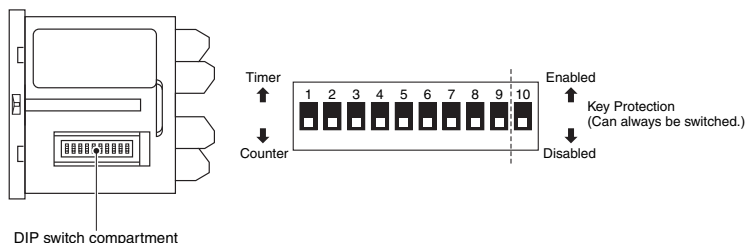

- Note 1. Set the DIP switch (except for Key Protection) before turning ON the power. Changes to DIP switch settings while the Counter is operating will be ignored. Power must be turned OFF then back ON after changing the settings. Changes to DIP switch settings are also enabled when changing to initial setting mode because the same operation is performed as when cycling the power.
2. Key protection can be set for each key. Key protection will be performed based on the details set in the initial setting mode. Refer to *Initial Setting Mode* on page 11.

### 2. Changing Mode

The system will always enter the RUN mode after the power supply is turned ON.

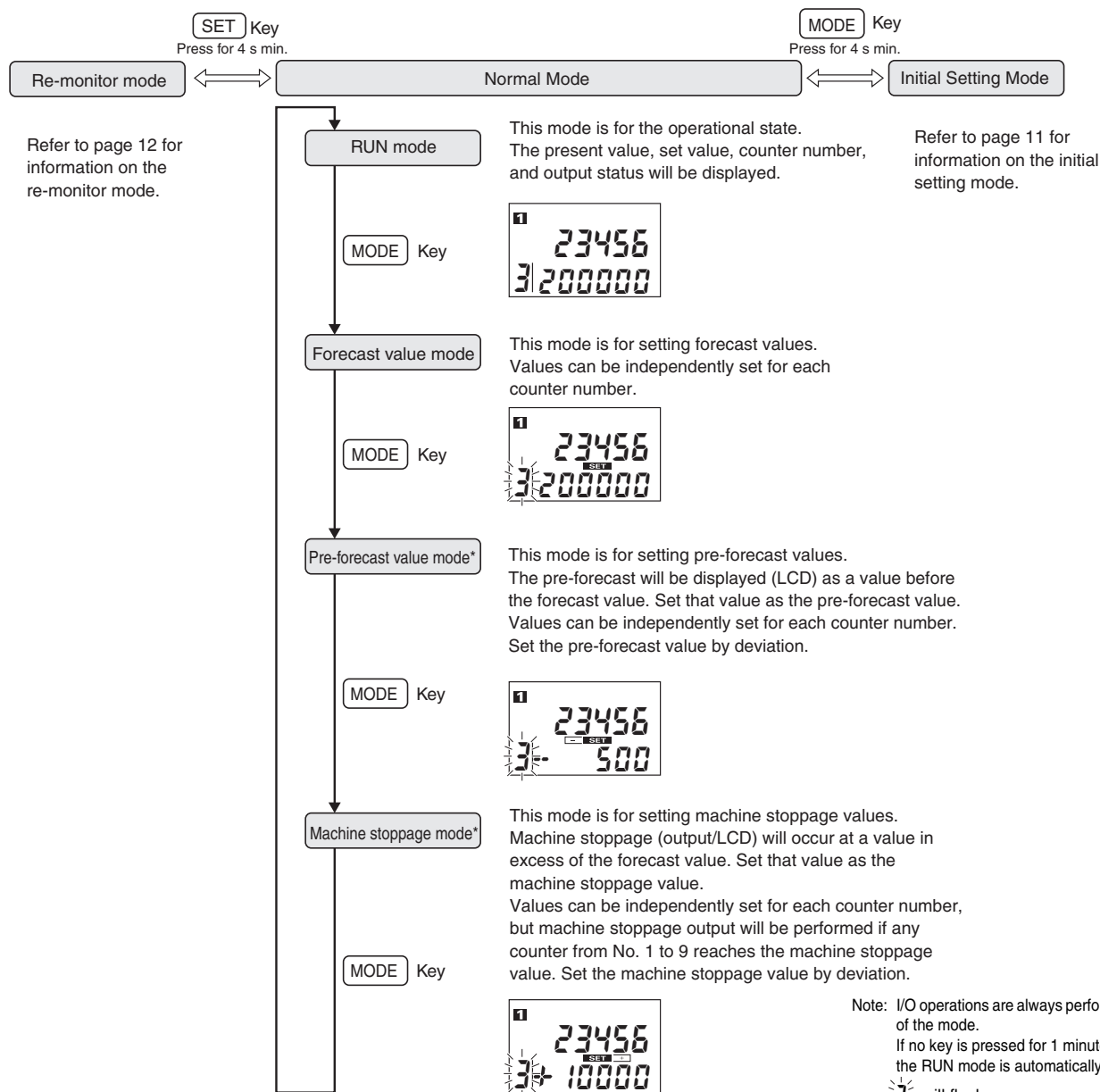



## 3. Setting/Changing Data

## ● Setting/Changing Forecast Value

1. In the RUN mode, press the

**MODE** Key to enter the forecast value setting mode.

- The same counter number as in the RUN mode is displayed after changing to forecast value mode.



2. Press the **CNT No.** Key (or turn ON the counter number selection input) to select the counter whose data is to be set or changed.

- The counters are selected in sequence each time the **CNT No.** Key is pressed, from 1 through 9, then back to 1.

1→2→3→4→5→6→7→8→9

- A counter can also be selected by inputting the counter number selection input.

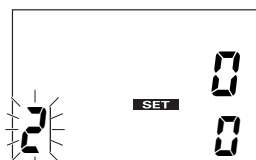

3. Use the **UP** Keys (**1** to **6**) to change the values of the digits.

- When an **UP** Key is pressed, the corresponding digit starts flashing.
- The preset value is zero-suppressed. Each time the **UP** Key is pressed, the value changes in sequence, from 1→2→3→4→5→6→7→8→9→0.

1→2→3→4→5→6→7→8→9→0

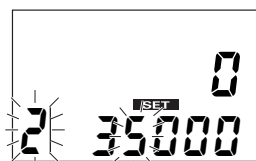
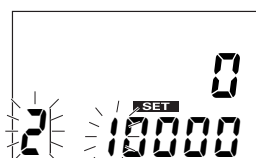

In the following example, the forecast value of counter 2 is set to 35000.

4. Press the **SET** Key to enter the set value.

- If no key is pressed within 5 seconds after the **SET** Key has been pressed, RUN mode is automatically restored.

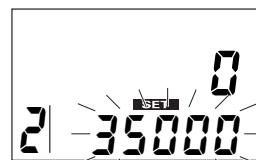

(The display is changed automatically after the set forecast value has flashed.)

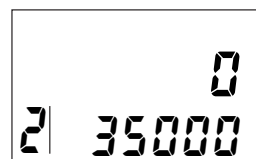

## ● Setting and Changing Pre-forecast Values (3-stage Type)

1. Press the **MODE** Key to enter the pre-forecast value setting mode.

- The same counter number as in the forecast value setting mode is displayed after changing to pre-forecast value mode.
- "-" is automatically displayed.

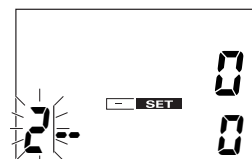

2. Press the **CNT No.** Key (or turn ON the counter number selection input) to select the counter whose data is to be set or changed.

Next, press the **UP** Key (**1** to **5**) to set or change the pre-forecast value.

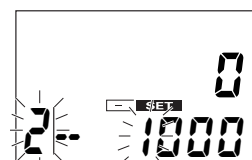

- The **CNT No.** Key does not need to be pressed if the counter does not need to be changed.

3. Press the **SET** Key to enter the set value.

- If no key is pressed within 5 seconds after the **SET** Key has been pressed, the RUN mode is automatically restored.

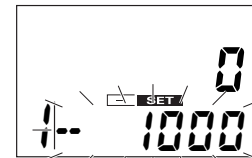

## ● Setting and Changing the Machine Stoppage Value (3-stage Type)

1. Press the **MODE** Key to enter the Machine Stoppage Value setting mode.

- The same counter number as in the pre-forecast value setting mode is displayed after changing to machine stoppage value setting mode.
- "+" is automatically displayed.

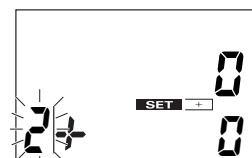

2. Press the **CNT No.** Key (or turn ON the counter number selection input) to select the counter whose data is to be set or changed.

Next, press the **UP** Key (**1** to **5**) to set or change the machine stoppage value.

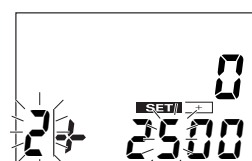

- The **CNT No.** Key does not need to be pressed if the counter does not need to be changed.

3. Press the **SET** Key to enter the set value.

- If no key is pressed within 5 seconds after the **SET** Key has been pressed, the RUN mode is automatically restored.

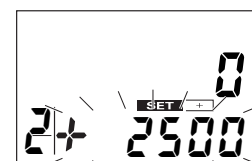

## 4. Special Set Values

### ● Setting Counters That Will Not Use the Machine

#### Stoppage Output (3-stage Type)

The machine stoppage output will not be used for counters for which the machine stoppage value has been set to +99999 (+9999.9 h/+9999.9 s).

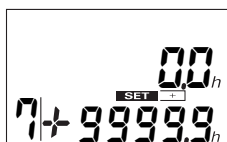
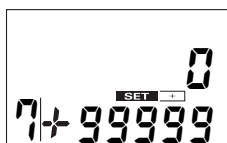

### ● Setting Counters That Will Not Be Used

Input and output operations will not occur for counters for which the forecast value has been set to 0 (0.0 h/0.0 s).

- If the forecast value is set to 0 (0.0 h/0.0 s), the pre-forecast and machine stoppage values will automatically be set to 0 (0.0 h/0.0 s).



### ● Setting Counters to Be Used as Total Counters/Timers

Counters can be used as total counters/timers if the forecast value for that counter is set to 999999 (99999.9 h/99999.9 s).

- The machine stoppage output will no longer be output for that counter.
- When using a counter as a total counter, the forecast output for that counter when the count value changes from 999999 to 0 will be a one-shot output of 20 ms to indicate a carry.



## 5. Checking Count Values (RUN Mode)

Press the **CNT No.** Key (or turn ON the counter No. selection input) in RUN mode to check the count value for each counter.



- The counter number changes in sequence each time the **CNT No.** Key is pressed (or the input turns ON), from 1 through 9, then back to 1.

1→2→3→4→5→6→7→8→9

Note: However, any counter whose forecast value is set to 0 (0.0 h/0.0 s) will be skipped.

## 6. Other Indicators

### Timer Operation Display

The period on the count value display will flash while the count input is ON and the Timer is in h mode.

- The timer operation measures time by totaling the ON time of the count input.



## 7. Deleting Count Value

### 1. Resetting Individual Counters

(1) Press the **CNT No.** Key (or turn ON the counter number selection input) to select the counter to be reset.

- The counter value can be reset in all modes except initial setting mode and re-monitor mode.

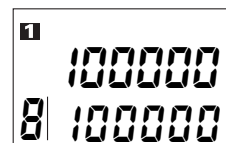

(2) Press the **RESET** Key (or turn ON the reset input) to reset the count value to 0 for that counter only.



### 2. Resetting of All Counters at the Same Time

Press and hold both the **CNT No.** and **RESET** Keys for 3 seconds to reset the count value for all counters to 0.

- The same operation is achieved by simultaneously turning ON the counter number selection and reset inputs for 3 seconds.

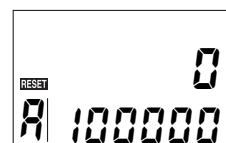

## 8. All Clear

Press and hold the **RESET** and **SET** Keys for 3 seconds to reset the count values, pre-forecast values, forecast values, and machine stoppage values to 0 for all counters.

- The counter number after All Clear has been executed will automatically change to 1.

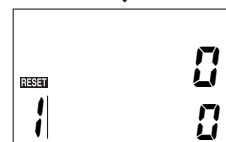

## 9. Control Output Display

The pre-forecast value, forecast, and machine stoppage status display will be as follows:

### ● Pre-forecast Values (3-stage Type)

The output display for counters for which the count value has reached the pre-forecast set value will be lit.

- Pre-forecast values are only displayed as a message and are not output.

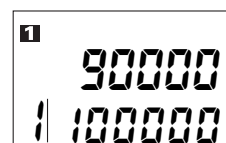

### ● Forecast Outputs

A red indicator will light at the top of the output display section for the lit counter number and the output will turn ON.

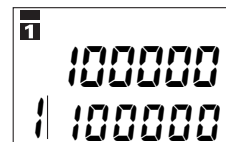

### ● Machine Stoppage Output (3-stage Type)

The entire background will alternate between red and green and the output display for the counter with a machine stoppage will flash.

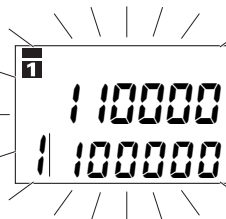

Note: If the pre-forecast, forecast, or machine stoppage output turns ON, the counter number display will automatically change to that number and the count value will be displayed (in RUN mode only).

## 10. Initial Setting Mode

This mode is for setting a number of convenient functions.

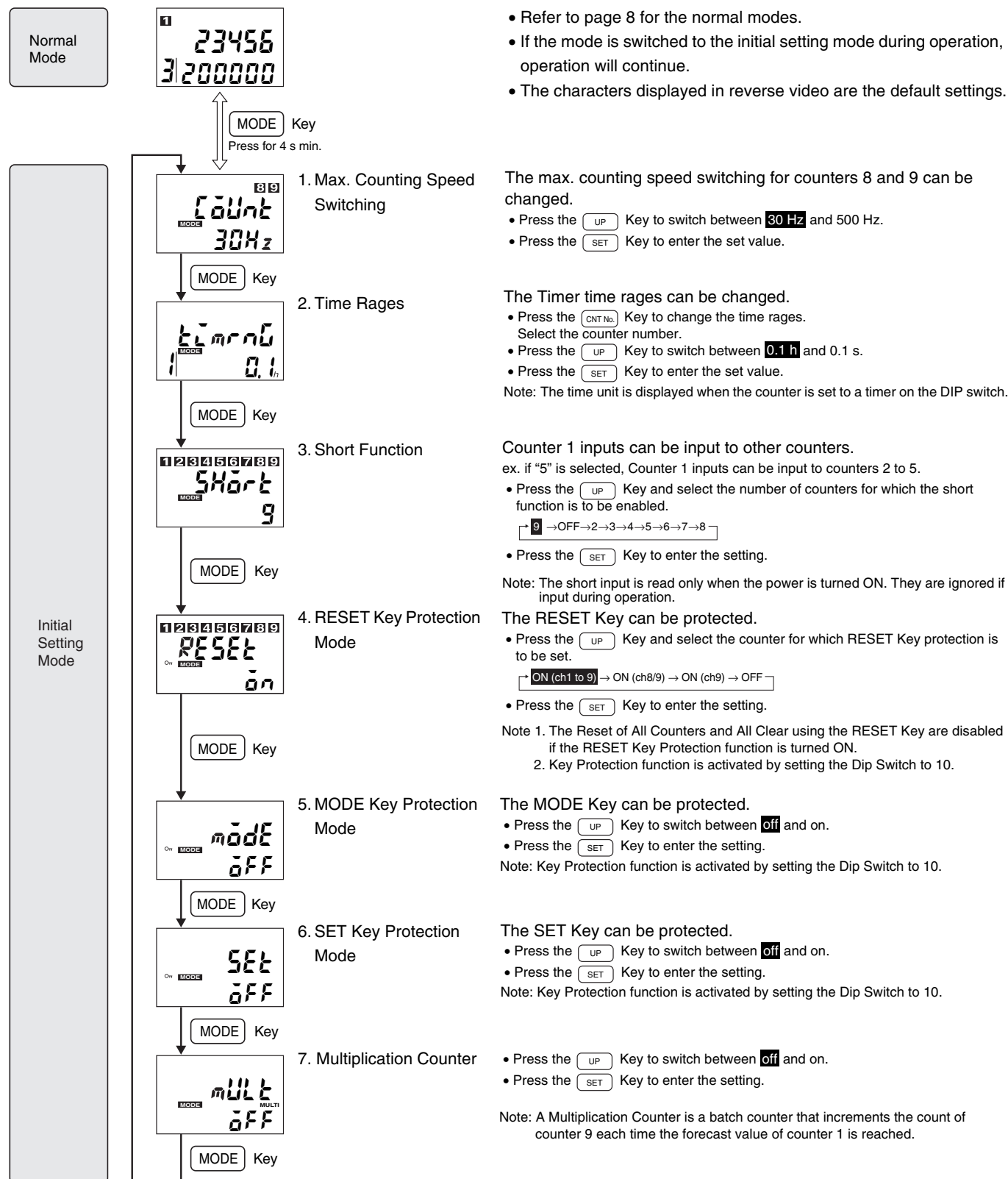

## 11. Re-monitor Mode

Use this mode to return to the count value before resetting if the count value is mistakenly reset.

1. In the RUN mode, hold the  Key for 4 seconds min. to change to re-monitor mode.

- The previous values that have been reset will be displayed.
- Only the display changes. Internal counting operations are not affected.
- The counter number remains unchanged on RUN display when the mode is changed to re-monitor display.

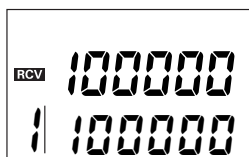

2. Press the  Key (or turn ON the counter number selection input) to select the counter to be re-monitored.



3. When the  Key is pressed (or the reset input turns ON), the re-monitor value will flash 3 times and the only the count value for that counter will be returned to the value prior to being reset.



## 12. Self-diagnosis Function

The following displays are made when errors occur.

| Display | Error content | All I/O    | Countermeasure  |
|---------|---------------|------------|---|
| E1      | CPU Errors    | Prohibited | Turn OFF the power or press the <input type="button" value="RESET"/> Key to clear the error and restore the settings and count values to the values before the error. |
| E2      | Memory Errors | Prohibited | Turn OFF the power or press the <input type="button" value="RESET"/> Key to clear the error and return the count values for all counters to 0.                        |
| E3      | Key Errors    | Prohibited | Turn OFF the power supply or press the <input type="button" value="RESET"/> Key to clear key errors.  |

## Terms and Conditions Agreement

### Read and understand this catalog.

Please read and understand this catalog before purchasing the products. Please consult your OMRON representative if you have any questions or comments.

### Warranties.

(a) Exclusive Warranty. Omron's exclusive warranty is that the Products will be free from defects in materials and workmanship for a period of twelve months from the date of sale by Omron (or such other period expressed in writing by Omron). Omron disclaims all other warranties, express or implied.

(b) Limitations. OMRON MAKES NO WARRANTY OR REPRESENTATION, EXPRESS OR IMPLIED, ABOUT NON-INFRINGEMENT, MERCHANTABILITY OR FITNESS FOR A PARTICULAR PURPOSE OF THE PRODUCTS. BUYER ACKNOWLEDGES THAT IT ALONE HAS DETERMINED THAT THE PRODUCTS WILL SUITABLY MEET THE REQUIREMENTS OF THEIR INTENDED USE.

Omron further disclaims all warranties and responsibility of any type for claims or expenses based on infringement by the Products or otherwise of any intellectual property right. (c) Buyer Remedy. Omron's sole obligation hereunder shall be, at Omron's election, to (i) replace (in the form originally shipped with Buyer responsible for labor charges for removal or replacement thereof) the non-complying Product, (ii) repair the non-complying Product, or (iii) repay or credit Buyer an amount equal to the purchase price of the non-complying Product; provided that in no event shall Omron be responsible for warranty, repair, indemnity or any other claims or expenses regarding the Products unless Omron's analysis confirms that the Products were properly handled, stored, installed and maintained and not subject to contamination, abuse, misuse or inappropriate modification. Return of any Products by Buyer must be approved in writing by Omron before shipment. Omron Companies shall not be liable for the suitability or unsuitability or the results from the use of Products in combination with any electrical or electronic components, circuits, system assemblies or any other materials or substances or environments. Any advice, recommendations or information given orally or in writing, are not to be construed as an amendment or addition to the above warranty.

See <http://www.omron.com/global/> or contact your Omron representative for published information.

### Limitation on Liability; Etc.

OMRON COMPANIES SHALL NOT BE LIABLE FOR SPECIAL, INDIRECT, INCIDENTAL, OR CONSEQUENTIAL DAMAGES, LOSS OF PROFITS OR PRODUCTION OR COMMERCIAL LOSS IN ANY WAY CONNECTED WITH THE PRODUCTS, WHETHER SUCH CLAIM IS BASED IN CONTRACT, WARRANTY, NEGLIGENCE OR STRICT LIABILITY.

Further, in no event shall liability of Omron Companies exceed the individual price of the Product on which liability is asserted.

### Suitability of Use.

Omron Companies shall not be responsible for conformity with any standards, codes or regulations which apply to the combination of the Product in the Buyer's application or use of the Product. At Buyer's request, Omron will provide applicable third party certification documents identifying ratings and limitations of use which apply to the Product. This information by itself is not sufficient for a complete determination of the suitability of the Product in combination with the end product, machine, system, or other application or use. Buyer shall be solely responsible for determining appropriateness of the particular Product with respect to Buyer's application, product or system. Buyer shall take application responsibility in all cases.

NEVER USE THE PRODUCT FOR AN APPLICATION INVOLVING SERIOUS RISK TO LIFE OR PROPERTY OR IN LARGE QUANTITIES WITHOUT ENSURING THAT THE SYSTEM AS A WHOLE HAS BEEN DESIGNED TO ADDRESS THE RISKS, AND THAT THE OMRON PRODUCT(S) IS PROPERLY RATED AND INSTALLED FOR THE INTENDED USE WITHIN THE OVERALL EQUIPMENT OR SYSTEM.

### Programmable Products.

Omron Companies shall not be responsible for the user's programming of a programmable Product, or any consequence thereof.

### Performance Data.

Data presented in Omron Company websites, catalogs and other materials is provided as a guide for the user in determining suitability and does not constitute a warranty. It may represent the result of Omron's test conditions, and the user must correlate it to actual application requirements. Actual performance is subject to the Omron's Warranty and Limitations of Liability.

### Change in Specifications.

Product specifications and accessories may be changed at any time based on improvements and other reasons. It is our practice to change part numbers when published ratings or features are changed, or when significant construction changes are made. However, some specifications of the Product may be changed without any notice. When in doubt, special part numbers may be assigned to fix or establish key specifications for your application. Please consult with your Omron's representative at any time to confirm actual specifications of purchased Product.

### Errors and Omissions.

Information presented by Omron Companies has been checked and is believed to be accurate; however, no responsibility is assumed for clerical, typographical or proofreading errors or omissions.

2015.7

In the interest of product improvement, specifications are subject to change without notice.

**OMRON Corporation**  
Industrial Automation Company

<http://www.ia.omron.com/>

(c)Copyright OMRON Corporation 2015 All Right Reserved.

# Mouser Electronics

Authorized Distributor

Click to View Pricing, Inventory, Delivery & Lifecycle Information:

[Omron:](#)

[H8BM-RB DC24](#)



Компания «ЭлектроПласт» предлагает заключение долгосрочных отношений при поставках импортных электронных компонентов на взаимовыгодных условиях!

Наши преимущества:

- Оперативные поставки широкого спектра электронных компонентов отечественного и импортного производства напрямую от производителей и с крупнейших мировых складов;
- Поставка более 17-ти миллионов наименований электронных компонентов;
- Поставка сложных, дефицитных, либо снятых с производства позиций;
- Оперативные сроки поставки под заказ (от 5 рабочих дней);
- Экспресс доставка в любую точку России;
- Техническая поддержка проекта, помощь в подборе аналогов, поставка прототипов;
- Система менеджмента качества сертифицирована по Международному стандарту ISO 9001;
- Лицензия ФСБ на осуществление работ с использованием сведений, составляющих государственную тайну;
- Поставка специализированных компонентов (Xilinx, Altera, Analog Devices, Intersil, Interpoint, Microsemi, Aeroflex, Peregrine, Syfer, Eurofarad, Texas Instrument, Miteq, Cobham, E2V, MA-COM, Hittite, Mini-Circuits, General Dynamics и др.);

Помимо этого, одним из направлений компании «ЭлектроПласт» является направление «Источники питания». Мы предлагаем Вам помощь Конструкторского отдела:

- Подбор оптимального решения, техническое обоснование при выборе компонента;
- Подбор аналогов;
- Консультации по применению компонента;
- Поставка образцов и прототипов;
- Техническая поддержка проекта;
- Защита от снятия компонента с производства.



#### Как с нами связаться

**Телефон:** 8 (812) 309 58 32 (многоканальный)

**Факс:** 8 (812) 320-02-42

**Электронная почта:** [org@eplast1.ru](mailto:org@eplast1.ru)

**Адрес:** 198099, г. Санкт-Петербург, ул. Калинина, дом 2, корпус 4, литера А.