



## Features

- Single-Turn / Cermet / Industrial / Sealed
- Miniature package
- Rotor designed for automatic machine adjust interface
- Withstands harsh environments and immersion cleaning processes
- Tape and reel packaging available

- RoHS compliant\* version available
- For trimmer applications/processing guidelines, [click here](#)

## 3362 - 1/4" Square Trimpot® Trimming Potentiometer

### Electrical Characteristics

Standard Resistance Range	10 to 2 megohms
	(see standard resistance table)
Resistance Tolerance	±10 % std.
	(tighter tolerance available)
Absolute Minimum Resistance	
	1 % or 2 ohms
	(whichever is greater)
Contact Resistance Variation	
	1 % or 3 ohms max.
	(whichever is greater)
Adjustability	
Voltage	±0.05 %
Resistance	±0.15 %
Resolution	Infinite
Insulation Resistance	500 vdc.
	1,000 megohms min.
Dielectric Strength	
Sea Level	900 vac
80,000 Feet	350 vac
Adjustment Angle	240 ° nom.

### Environmental Characteristics

Power Rating (300 volts max.)	
70 °C	0.50 watt
125 °C	0 watt
Temperature Range	-55 °C to +125 °C
Temperature Coefficient	±100 ppm/°C
Seal Test	85 °C Fluorinert†
Humidity	MIL-STD-202 Method 103
	96 hours
	(2 % ΔTR; 10 Megohms IR)
Vibration	30 G (1 % ΔTR; 1 % ΔVR)
Shock	100 G (1 % ΔTR; 1 % ΔVR)
Load Life	1,000 hours 0.5 watt @ 70 °C
	(3 % ΔTR; 3 % or 3 ohms,
	whichever is greater, CRV)
Rotational Life	200 cycles
	(4 % ΔTR; 3 % or 3 ohms,
	whichever is greater, CRV)

### Physical Characteristics

Mechanical Angle	270 ° nom.
Torque	3.0 oz-in. max.
Stop Strength	7.0 oz -in. min.
Terminals	Solderable pins
Weight	0.02 oz.
Marking	Resistance code,
	terminal numbers, manufacturer's
	model number, style
	and date code
Wiper	50 % (Actual TR) ±10 %
Flammability	U.L. 94V-0
Standard Packaging	50 pcs. per tube
Adjustment Tool	H-90

### Product Dimensions

#### Common Dimensions



#### 3362F

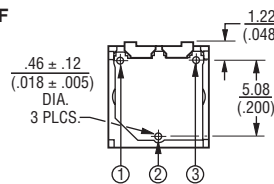

#### 3362H

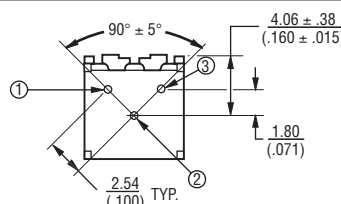

#### 3362P

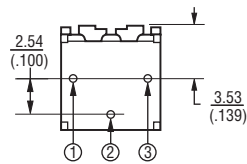

#### 3362R

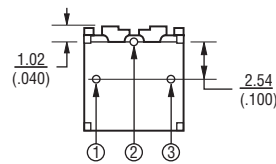

#### 3362U

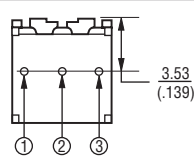

#### Common Dimensions

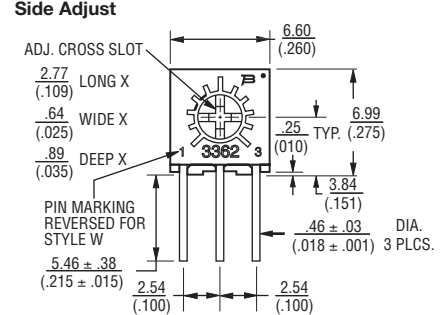

#### 3362M



#### 3362S

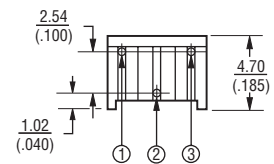

#### 3362W

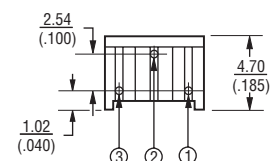

#### 3362X

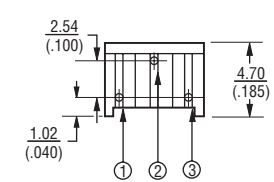

#### 3362Z

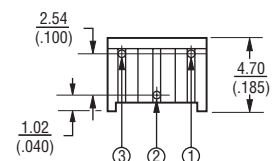

DIMENSIONS:  $\frac{\text{MM}}{\text{(INCHES)}}$   
 TOLERANCES:  $\pm \frac{0.25}{(0.010)}$  EXCEPT WHERE NOTED

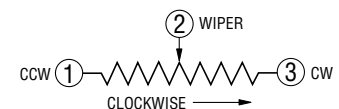

\*RoHS Directive 2002/95/EC Jan 27 2003 including Annex.  
 †"Fluorinert" is a registered trademark of 3M Co.  
 Specifications are subject to change without notice.  
 Customers should verify actual device performance in their specific applications.

# 3362 - 1/4 " Square Trimpot® Trimming Potentiometer **BOURNS®**

## Product Dimensions

Top adjust models 3362F, H, P, R and U are available with a knob for finger adjustment. Add suffix letter "T" to order code.



DIMENSIONS:  $\frac{\text{MM}}{\text{(INCHES)}}$   
TOLERANCES: ±  $\frac{0.25}{(.010)}$  EXCEPT WHERE NOTED

## Packaging Specifications

### SIDE ADJUST 3362M-1



### TOP ADJUST 3362U-1, 3362P-1



#### SIDE VIEW 3362U-1



#### SIDE VIEW 3362P-1



ALL PINS IN-LINE ON  $\frac{2.54}{(.100)}$  CENTER  
DIMENSIONS:  $\frac{\text{MM}}{\text{(INCHES)}}$   
750/REEL  
1000/BOX

Meets EIA Specification 468.

## How To Order

**3362 P - 1 - 502 T LF**

Model \_\_\_\_\_  
Style \_\_\_\_\_  
Standard or Modified \_\_\_\_\_  
Product Indicator \_\_\_\_\_  
-1 = Standard Product  
Resistance Code \_\_\_\_\_  
Optional Suffix Letter \_\_\_\_\_  
T = Knob\*  
Packaging Designator \_\_\_\_\_  
Blank = Tube (Standard)  
R = Tape and Reel  
(M, U and P Pin Styles Only)  
A = Ammo Pack  
(M, U and P Pin Styles Only)  
Terminations \_\_\_\_\_  
LF = 100 % Tin-plated (RoHS compliant)  
Blank = 90 % Tin / 10 % Lead-plated  
(Standard)

\*Knob option is available only in standard Tube packaging for terminal styles F, H, P, R and U.  
Consult factory for other available options.

## Standard Resistance Table

Resistance (Ohms)	Resistance Code
10	100
20	200
50	500
<b>100</b>	<b>101</b>
<b>200</b>	<b>201</b>
<b>500</b>	<b>501</b>
<b>1,000</b>	<b>102</b>
<b>2,000</b>	<b>202</b>
<b>5,000</b>	<b>502</b>
<b>10,000</b>	<b>103</b>
<b>20,000</b>	<b>203</b>
<b>25,000</b>	<b>253</b>
<b>50,000</b>	<b>503</b>
<b>100,000</b>	<b>104</b>
200,000	204
250,000	254
500,000	504
1,000,000	105
2,000,000	205

Popular distribution resistance values listed in boldface. Special resistances available.

REV. 08/26/10

"Trimpot" is a registered trademark of Bourns, Inc.  
Specifications are subject to change without notice.  
Customers should verify actual device performance in their specific applications.



Компания «ЭлектроПласт» предлагает заключение долгосрочных отношений при поставках импортных электронных компонентов на взаимовыгодных условиях!

Наши преимущества:

- Оперативные поставки широкого спектра электронных компонентов отечественного и импортного производства напрямую от производителей и с крупнейших мировых складов;
- Поставка более 17-ти миллионов наименований электронных компонентов;
- Поставка сложных, дефицитных, либо снятых с производства позиций;
- Оперативные сроки поставки под заказ (от 5 рабочих дней);
- Экспресс доставка в любую точку России;
- Техническая поддержка проекта, помощь в подборе аналогов, поставка прототипов;
- Система менеджмента качества сертифицирована по Международному стандарту ISO 9001;
- Лицензия ФСБ на осуществление работ с использованием сведений, составляющих государственную тайну;
- Поставка специализированных компонентов (Xilinx, Altera, Analog Devices, Intersil, Interpoint, Microsemi, Aeroflex, Peregrine, Syfer, Eurofarad, Texas Instrument, Miteq, Cobham, E2V, MA-COM, Hittite, Mini-Circuits, General Dynamics и др.);

Помимо этого, одним из направлений компании «ЭлектроПласт» является направление «Источники питания». Мы предлагаем Вам помощь Конструкторского отдела:

- Подбор оптимального решения, техническое обоснование при выборе компонента;
- Подбор аналогов;
- Консультации по применению компонента;
- Поставка образцов и прототипов;
- Техническая поддержка проекта;
- Защита от снятия компонента с производства.



#### Как с нами связаться

**Телефон:** 8 (812) 309 58 32 (многоканальный)

**Факс:** 8 (812) 320-02-42

**Электронная почта:** [org@eplast1.ru](mailto:org@eplast1.ru)

**Адрес:** 198099, г. Санкт-Петербург, ул. Калинина, дом 2, корпус 4, литера А.