

# Easy-wire connectors for Industrial Components

# XN2

## Easy-wire Connectors with *e-CON*\* Specifications; Ideal for Connecting Sensors.

- Uses industry-proven spring clamps for wiring.
- No special tools required for easy wiring.
- Easy to rewire and repair
- Each Connector accepts any wire size from AWG28 (0.08 mm<sup>2</sup>) to AWG20 (0.5 mm<sup>2</sup>). (External sheath diameter: 1.5 mm max.)
- RoHS Compliant

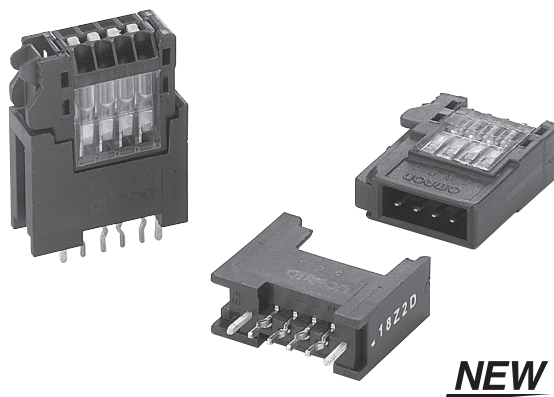

\*E-con specifications are currently being promoted for standardization by manufacturers of FA components and connectors.

## Wiring Configuration Example

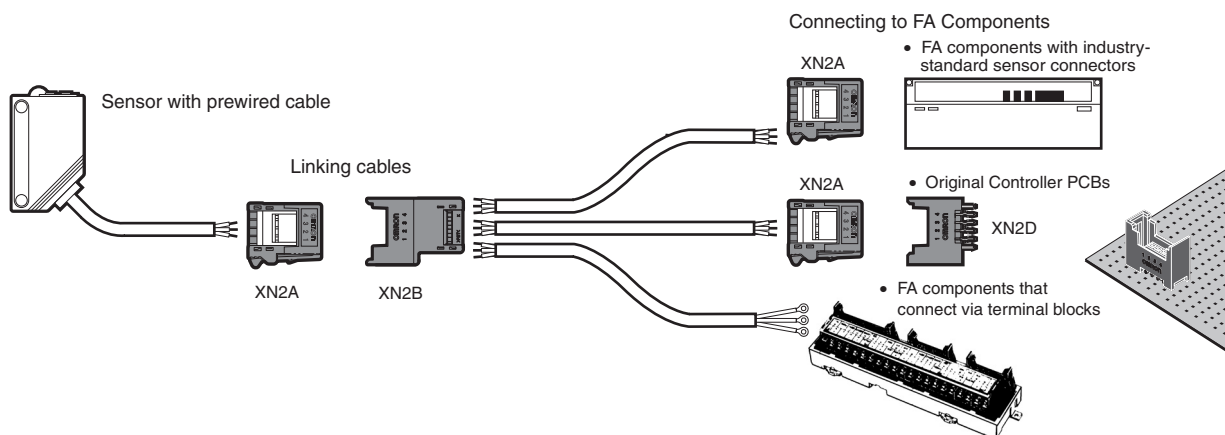

## Ordering Information

Type	Cable Plug Connector	Cable Socket Connector	Single-socket PCB Socket Connector	Four-socket PCB Socket Connector
Appearance				
No. of contacts	Model	Model	Model	Model
3	XN2A-1370	---	XN2D-1371	---
4	XN2A-1470	XN2B-1470	XN2D-1471	XN2D-4471
5	XN2A-1570	---	XN2D-1571	---
6	XN2A-1670	---	XN2D-1671	---
8	XN2A-1870	---	XN2D-1871	---

# Ratings and Specifications

Rated current	3 A/pole, using AWG20 (0.5 mm <sup>2</sup> ) wire 2 A/pole, using AWG22 (0.3 mm <sup>2</sup> ) wire 1 A/pole, using AWG24 (0.2 mm <sup>2</sup> ) wire 0.5 A/pole, using AWG26 (0.1 mm <sup>2</sup> ) or AWG28 (0.08 mm <sup>2</sup> ) wire
Rated voltage	32 VDC
Contact resistance (See note 1.)	30 mΩ max. (20 mVDC max., 100 mA max.)
Insulation resistance	1,000 MΩ min. (at 500 VDC)
Dielectric strength	1,000 VAC for 60 s (leakage current: 1 mA max.)
Insertion tolerance	50 times
Ambient temperature (See note 2.)	Operating: -30°C to 75°C
Applicable wires (See note 3.)	0.08 mm <sup>2</sup> (AWG28) to 0.5mm <sup>2</sup> (AWG20) The external diameter of the cable sheath is 1.5 mm max.

- Note:**
1. This value is the contact resistance of the connector.
  2. The temperature is limited, however, to the maximum operating temperature for the cables.
  3. Avoid using wires with a single strand diameter of 0.16 mm or smaller.

# Materials and Finish

Item	Cable Types	PCB Types
Housing	Black PBT resin (UL94V-0)	
Cover	Black PBT resin (UL94V-0)	---
Base	Transparent PC resin (UL94V-0)	---
Lever	PA resin (UL94V-0)/natural (white)	---
Contact	Phosphor bronze/Underplating: Nickel (1.5 to 3.0 μm) Contacts: Gold (0.2 μm min.) Terminals: Tin plating (1.0 μm min.)	
Spring	Stainless steel	---
Fastening pins	---	Copper alloy/nickel base with tin plating

# Dimensions (Unit: mm)

## Cable Plug Connector XN2A-1□70

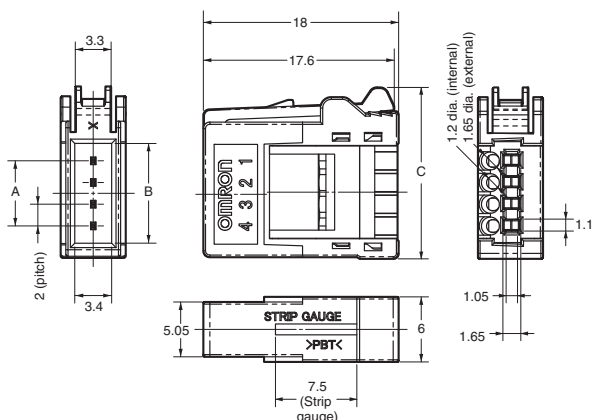

Dimensions

Dimension (mm)	A	B	C
No. of contacts			
3	4.0	7.2	13.8
4	6.0	9.2	15.8
5	8.0	11.2	17.8
6	10.0	13.2	19.8
8	14.0	17.2	23.8

### Cable Socket Connector XN2B-1470

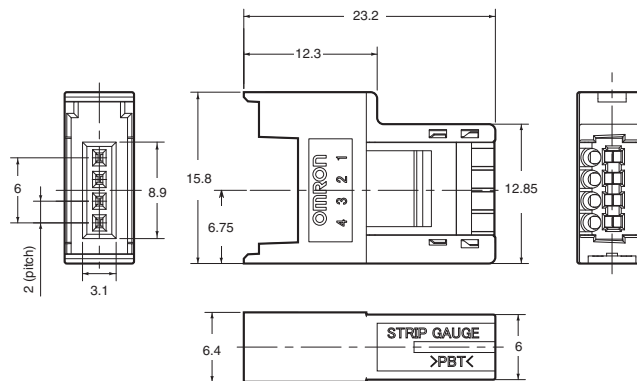

### Single-socket PCB Socket Connector XN2D-1□71

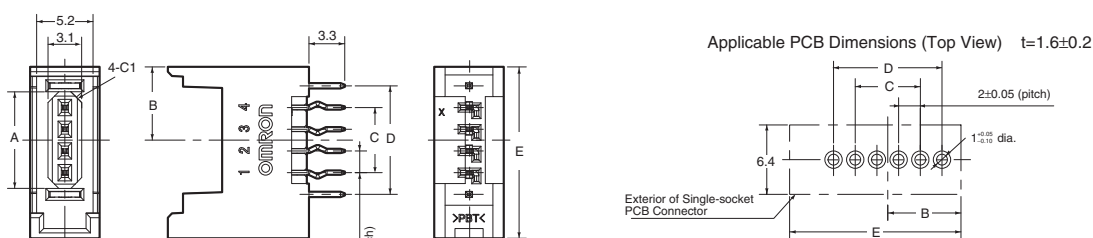

#### Dimensions

Dimension (mm)	A	B	C	D	E
No. of contacts					
3	6.9	5.8	4.0	8.0	13.8
4	8.9	6.8	6.0	10.0	15.8
5	10.9	7.8	8.0	12.0	17.8
6	12.9	8.8	10.0	14.0	19.8
8	16.9	10.8	14.0	18.0	23.8

### Four-socket PCB Socket Connector XN2D-4471

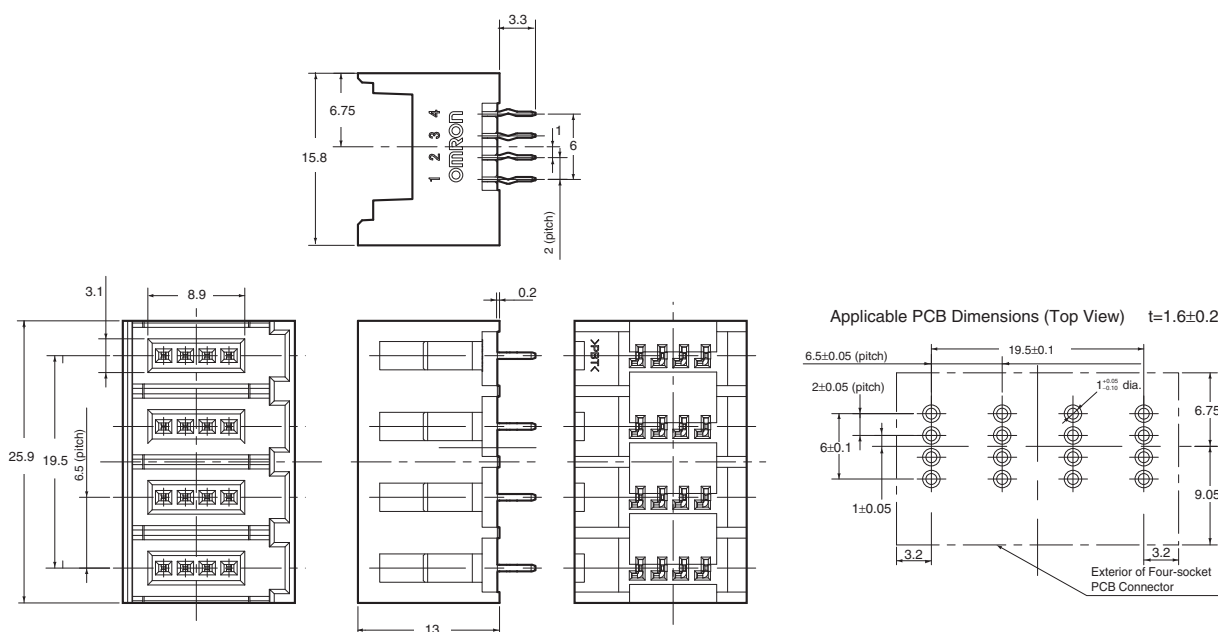

# Assembly Instructions

## Preparing the Cable

Align the cable with the guide marked STRIP GAUGE on the side of the Connector, strip 7 to 8 mm of the cable sheath, and then twist the wires several times.

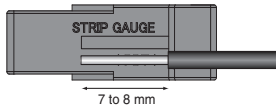

## Connecting the Cable to the Connector

1. Use a flat-blade screwdriver to push down the operating lever inside the operation slot until it locks.

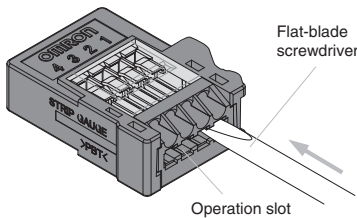

2. Insert the wire fully to the back of the wire insertion hole. Make sure that the cable sheath is inserted into the hole, and that the end of the wire has passed through the contact section.

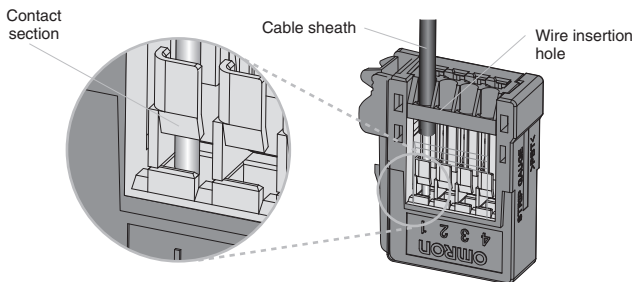

3. Insert the screwdriver into the release slot, and gently pull back the lever until a click is heard by resetting the lever.

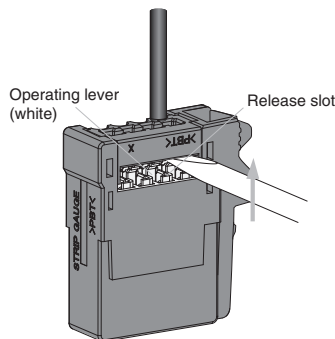

4. Make sure that the following operations have been performed.

- Check that the operating lever is reset.
- Check that the procedure in step 2 has been followed. (Pull gently on the cable to make sure that there is resistance, indicating that the Connectors are wired correctly.)

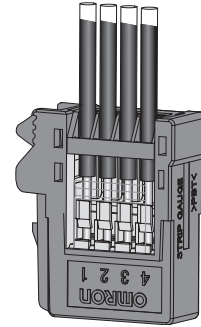

## Removing Cables from the Connector

1. Press down on the operating lever to lock the lever before removing the cable.

2. After removing the cable from the Connector, always reset the operating lever, except when rewiring the Connector. The Connector can be rewired without resetting the operating lever.

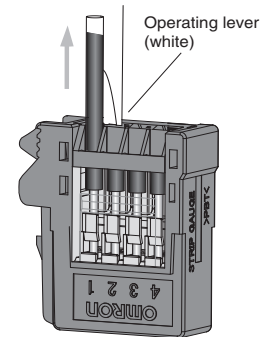

# Safety Precautions

---

## ■ General Precautions

- Do not pull on the Connectors or cables. Doing so may cause damage to the Connectors or cause the cables to disconnect.
- Install the Connectors in a location where they will not be stepped on, to prevent disconnection of the cables or damage to the Connectors. If the Connectors have to be installed in such a location, use a protective cover.
- Make sure that the Connectors are mated in the correct direction. Mating the Connectors incorrectly will damage to the Connectors.
- Do not use the Connectors if the lock lever is bent or broken. Doing so may cause the Connector to become loose or the device to malfunction.
- Before mounting Connectors to a PCB, make sure that the Connectors are positioned in the correct direction.
- Before bending a cable to connect it to a Connector, check the bending specifications of the cable to be used.
- Do not exceed the rated current of the cable. Always check the rated current of each cable to be used.
- Do not use pliers or other tools to remove the Connectors.
- Hold the Connectors firmly by hand when handling them. Do not use excessive force to push the Connectors. Forcing the Connectors may result in injury.
- These Connectors do not resist water. Do not use Connectors in places where water or oil may be sprayed onto the Connectors.

## ■ Precautions for Correct Use

### Wiring

- Insert one wire into each insertion hole. Inserting two or more wires into a single hole may cause unexpected problems.
- Make sure that no power is being supplied to a Connector before wiring, inserting, or removing the Connector. Doing so may result in electric shock.
- Follow the wiring diagrams for the device being used when wiring the cables.
- Strip the cables according to the instructions in the applicable operation manual, making sure not to damage the wires.
- Do not use a screwdriver with a tip larger than the specified width when wiring the Connectors.
- Make sure short-circuits are not created, e.g., by protruding wires.

### Inserting and Removing Connectors

- When connecting or disconnecting Connectors, always hold the case of the Connector.
- When mating Connectors, insert the Connector fully into the back of the socket, and then make sure that the Connector will not become loose by lightly pulling it in the opposite direction.

### Recommended Screwdriver

- Use a flat-blade screwdriver with a tip of 2 mm max. Do not use screwdrivers that gradually widen towards the base of the screwdriver.
- Using other screwdrivers may cause damage to the adjacent poles.

All sales are subject to Omron Electronic Components LLC standard terms and conditions of sale, which can be found at [http://www.components.omron.com/components/web/webfiles.nsf/sales\\_terms.html](http://www.components.omron.com/components/web/webfiles.nsf/sales_terms.html)

**ALL DIMENSIONS SHOWN ARE IN MILLIMETERS.**  
To convert millimeters into inches, multiply by 0.03937. To convert grams into ounces, multiply by 0.03527.

---

**OMRON**<sup>®</sup>

**OMRON ELECTRONIC  
COMPONENTS LLC**

55 E. Commerce Drive, Suite B  
Schaumburg, IL 60173

**847-882-2288**

**OMRON ON-LINE**

Global - <http://www.omron.com>

USA - <http://www.components.omron.com>



Компания «ЭлектроПласт» предлагает заключение долгосрочных отношений при поставках импортных электронных компонентов на взаимовыгодных условиях!

Наши преимущества:

- Оперативные поставки широкого спектра электронных компонентов отечественного и импортного производства напрямую от производителей и с крупнейших мировых складов;
- Поставка более 17-ти миллионов наименований электронных компонентов;
- Поставка сложных, дефицитных, либо снятых с производства позиций;
- Оперативные сроки поставки под заказ (от 5 рабочих дней);
- Экспресс доставка в любую точку России;
- Техническая поддержка проекта, помощь в подборе аналогов, поставка прототипов;
- Система менеджмента качества сертифицирована по Международному стандарту ISO 9001;
- Лицензия ФСБ на осуществление работ с использованием сведений, составляющих государственную тайну;
- Поставка специализированных компонентов (Xilinx, Altera, Analog Devices, Intersil, Interpoint, Microsemi, Aeroflex, Peregrine, Syfer, Eurofarad, Texas Instrument, Miteq, Cobham, E2V, MA-COM, Hittite, Mini-Circuits, General Dynamics и др.);

Помимо этого, одним из направлений компании «ЭлектроПласт» является направление «Источники питания». Мы предлагаем Вам помощь Конструкторского отдела:

- Подбор оптимального решения, техническое обоснование при выборе компонента;
- Подбор аналогов;
- Консультации по применению компонента;
- Поставка образцов и прототипов;
- Техническая поддержка проекта;
- Защита от снятия компонента с производства.



#### Как с нами связаться

**Телефон:** 8 (812) 309 58 32 (многоканальный)

**Факс:** 8 (812) 320-02-42

**Электронная почта:** [org@eplast1.ru](mailto:org@eplast1.ru)

**Адрес:** 198099, г. Санкт-Петербург, ул. Калинина, дом 2, корпус 4, литера А.