



FCIconnect.com

Copyright FCI.

1

2

Configuration of customer Documents list

P/N	Documents	No.	Title
SLW__R/S-5C7LF	SPEC	SC-SLW04	
	DWG	JSA96303	CAT NO. TABLE FOR 1mm SPACING CONNECTOR
		JSA96304	1mm SPACING CONNECTOR
		JSA96305	1mm SPACING CONNECTOR
	Cable	JSA92759	RECOMMENDED CABLE (CIC)

P/N	Documents	No.	Title
SLW__R/S-5A7LF	SPEC	SC-SLW04	
	DWG	JSA96309	CAT NO. TABLE FOR 1mm SPACING CONNECTOR
		JSA96310	1mm SPACING CONNECTOR
		JSA96311	1mm SPACING CONNECTOR
	Cable	JSA92759	RECOMMENDED CABLE (CIC)

mat'l. code				surface ISO 1302 <input checked="" type="checkbox"/>		tolerance ISO 406 ISO 1101		projection 		product family 58JF/TF		CODE JP	
ltr	ecn no	dr	date	tolerances unless otherwise specified				mm		title 1mm SPACING CONNECTOR DOCUMENT LIST (Cat. No. SLW__R/S-5__LF)			
A	J05-0079	H.T	'05/2/18	angles	linear			scale \propto		dwg no		sheet 1 of 1 size	
B	J06-0459	H.T	11/8/06							JSA96342		A4	
		dr	<i>K. Shouji</i>			11/8/06				type		Product Customer Drawing	
		enr	<i>K. Shouji</i>			11/8/06							
		chr	<i>R. Shouji</i>			11/9/06							
		app	<i>S. Adachi</i>			11/9/06							
sheet index	revision sheet	B	1									Rev. B	

form: A4

1

2

CAT. NO. & DIMENSIONS

NO. OF CONTACTS (n)	CAT. NO.		DIMENSIONS (NOTE1)	
	RIGHT ANGLE TYPE	STRAIGHT TYPE	A ± 0.3	B ± 0.3
4	SLW 4 R-5C7LF	SLW 4 S-5C7LF	10.2	5.2
5	SLW 5 R-5C7LF	SLW 5 S-5C7LF	11.2	6.2
6	SLW 6 R-5C7LF	SLW 6 S-5C7LF	12.2	7.2
7	SLW 7 R-5C7LF	SLW 7 S-5C7LF	13.2	8.2
8	SLW 8 R-5C7LF	SLW 8 S-5C7LF	14.2	9.2
9	SLW 9 R-5C7LF	SLW 9 S-5C7LF	15.2	10.2
10	SLW 10 R-5C7LF	SLW 10S-5C7LF	16.2	11.2
11	SLW 11 R-5C7LF	SLW 11S-5C7LF	17.2	12.2
12	SLW 12 R-5C7LF	SLW 12S-5C7LF	18.2	13.2
13	SLW 13 R-5C7LF	SLW 13S-5C7LF	19.2	14.2
14	SLW 14 R-5C7LF	SLW 14S-5C7LF	20.2	15.2
15	SLW 15 R-5C7LF	SLW 15S-5C7LF	21.2	16.2
16	SLW 16 R-5C7LF	SLW 16S-5C7LF	22.2	17.2
17	SLW 17 R-5C7LF	SLW 17S-5C7LF	23.2	18.2
18	SLW 18 R-5C7LF	SLW 18S-5C7LF	24.2	19.2
19	SLW 19 R-5C7LF	SLW 19S-5C7LF	25.2	20.2
20	SLW 20 R-5C7LF	SLW 20S-5C7LF	26.2	21.2
21	SLW 21 R-5C7LF	SLW 21S-5C7LF	27.2	22.2
22	SLW 22 R-5C7LF	SLW 22S-5C7LF	28.2	23.2
23	SLW 23 R-5C7LF	SLW 23S-5C7LF	29.2	24.2
24	SLW 24 R-5C7LF	SLW 24S-5C7LF	30.2	25.2
25	SLW 25 R-5C7LF	SLW 25S-5C7LF	31.2	26.2
26	SLW 26 R-5C7LF	SLW 26S-5C7LF	32.2	27.2
27	SLW 27 R-5C7LF	SLW 27S-5C7LF	33.2	28.2
28	SLW 28 R-5C7LF	SLW 28S-5C7LF	34.2	29.2
29	SLW 29 R-5C7LF	SLW 29S-5C7LF	35.2	30.2
30	SLW 30 R-5C7LF	SLW 30S-5C7LF	36.2	31.2

CAT. NO. SLW (n) R - 5C7 LF NOTE

SERIES NAME _____
 NO. OF CONTACTS _____
 R:RIGHT ANGLE TYPE
 S:STRAIGHT TYPE
 VARIATION _____
 LEAD FREE _____

1. SEE PART DRAWINGS FOR DIMENSIONS A,B.

mat'l. code				surface ISO 1302 <input checked="" type="checkbox"/>	tolerance ISO 406 ISO 1101	projection	product family 58JF/TF	CODE JP
ltr	ecn no	dr	date	tolerances unless otherwise specified		mm	title	
A	J05-0079	H.T	'05/2/15	angles	linear		CAT NO. TABLE FOR 1mm SPACING CONNECTOR (Cat. No. SLW__R/S-5C7LF)	
B	J06-0459	H.T	11/8/'06			scale \times	dwg no sheet 1 of 1 size	
				dr	<i>H. J. J. 11/8/06</i>		JSA 96303 A4	
				enr	<i>H. J. J. 11/8/06</i>		type Product Customer Drawing	
				chr	<i>R. Shoupe 11/9/06</i>			
				app	<i>S. J. J. 11/9/06</i>			
sheet index	revision sheet	B 1						Rev. B

SC-SLW04 JSA96304 96305 92759 form: A4



FCIconnect.com

Copyright FCI.

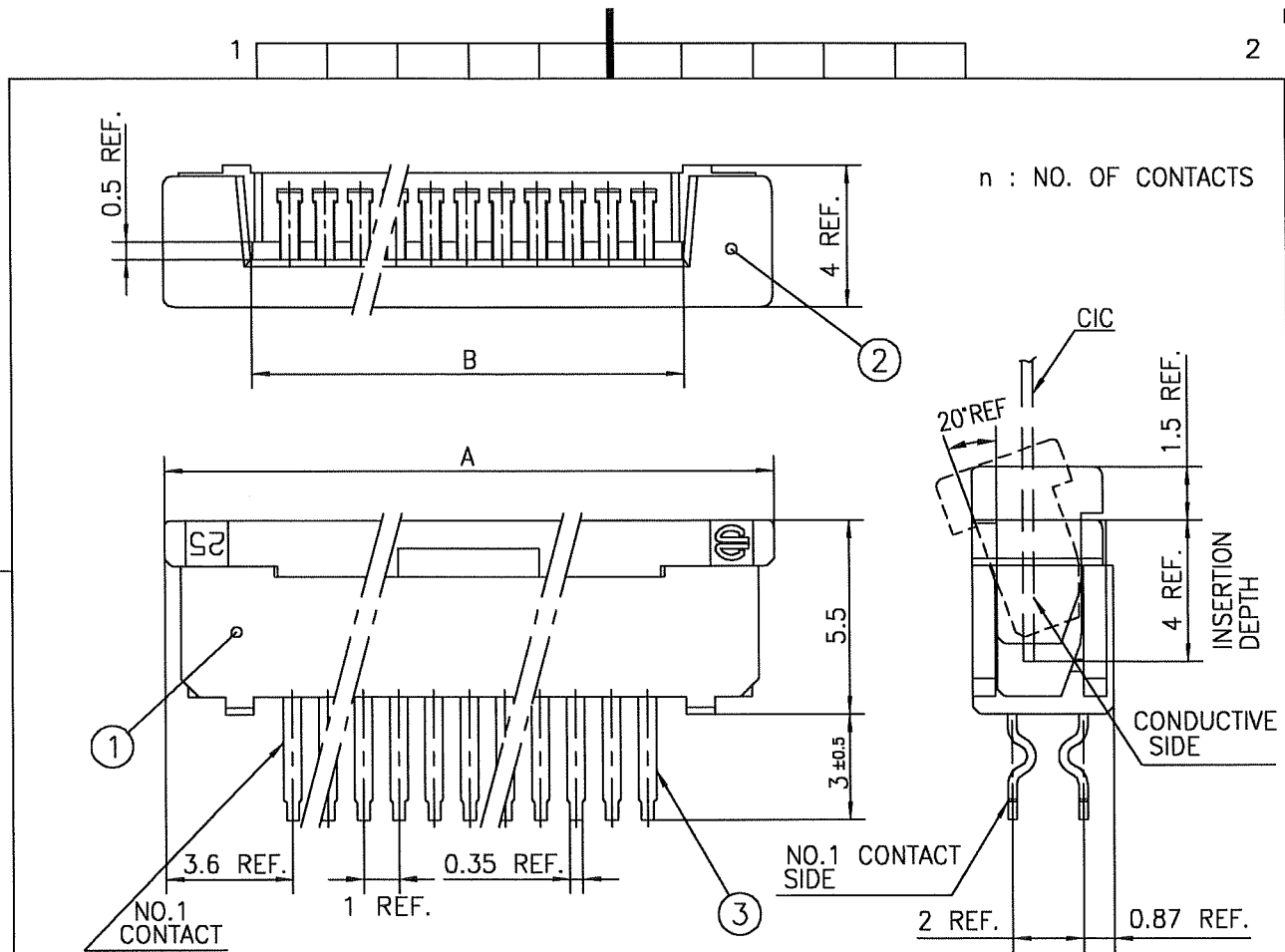

PT.NO.	PARTS NAME	MATERIAL	Q'TY	NOTE
1	HOUSING	NYLON RESIN GLASS REINFORCED (UL94V-0)	1	COLOR : BLACK
2	SLIDER		1	COLOR : WHITE
3	CONTACT	PHOSPHOR BRONZE	n	PLATING : MATTE PURE TIN (LEAD FREE)

RECOMMENDED PC BOARD
 THICKNESS : 0.8~1.6
 HOLE PATTERN (COMPONENT SIDE)

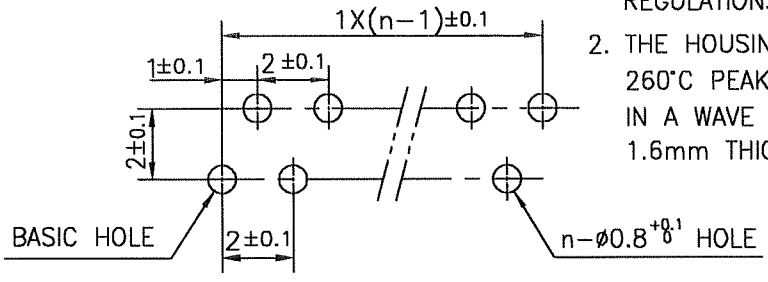

1. THIS PRODUCT MEETS EUROPEAN UNION DIRECTIVES AND OTHER COUNTRY REGULATIONS AS DESCRIBED IN GS-22-008
2. THE HOUSING WILL WITHSTAND EXPOSURE TO 260°C PEAK TEMPERATURE FOR 10 SECONDS IN A WAVE SOLDER APPLICATION WITH A 1.6mm THICK CIRCUIT BOARD.

mat'l. code				surface ISO 1302 ✓		tolerance ISO 406 ISO 1101		projection		product family 58JF		CODE JP	
ltr	ecn no	dr	date	tolerances unless otherwise specified				mm		title			
A	J05-0079	H.T	'05/2/15	angles		linear ± 0.3		mm		1mm SPACING CONNECTOR (Cat. No. SLW__S-5C7LF)			
B	J05-0734	H.T	10/28/'05					scale X					
C	J06-0459	H.T	11/8/'06							dwg no		sheet 1 of 1 size	
				dr		11/2/06				JSA 96304		A4	
				enrg		11/2/06				type		Product Customer Drawing	
				chr		11/9/06							
				appd		11/9/06							
sheet index		revision sheet		C		1						Rev. c	

SC-SLW04 JSA96303
 form: A4



n : NO. OF CONTACTS

PT.NO.	PARTS NAME	MATERIAL	Q'TY	NOTE
1	HOUSING	NYLON RESIN GLASS REINFORCED	1	COLOR : BLACK
2	SLIDER	(UL94V-0)	1	COLOR : WHITE
3	CONTACT	PHOSPHOR BRONZE	n	PLATING : MATTE PURE TIN (LEAD FREE)

RECOMMENDED PC BOARD
 THICKNESS : 0.8~1.6
 HOLE PATTERN (COMPONENT SIDE)



1. THIS PRODUCT MEETS EUROPEAN UNION DIRECTIVES AND OTHER COUNTRY REGULATIONS AS DESCRIBED IN GS-22-008
2. THE HOUSING WILL WITHSTAND EXPOSURE TO 260°C PEAK TEMPERATURE FOR 10 SECONDS IN A WAVE SOLDER APPLICATION WITH A 1.6mm THICK CIRCUIT BOARD.

mat'l. code				surface ISO 1302 ✓		tolerance ISO 406 ISO 1101		projection		product family 58TF		CODE JP			
ltr	ecn no	dr	date	tolerances unless otherwise specified				mm		title					
A	J05-0079	H.T	'05/2/15	±0.3				mm		1mm SPACING CONNECTOR					
B	J05-0734	H.T	10/28/'05	linear				mm		(Cat. No. SLW__R-5C7LF)					
C	J06-0459	H.T	11/8/'06					scale X							
				dr		11/8/06				dwg no		sheet 1 of 1		size	
				enrg		11/8/06				JSA 96305		A4			
				chr		11/9/06									
				appd		11/9/06				type Product Customer Drawing					
sheet index		revision sheet		C		1						Rev. C			

SC-SLW04 JSA96303
form: A4

RECOMMENDED CABLE (CIC)



PT. NO.	PARTS NAME	MATERIAL	THICKNESS (μm)	
1	BASE FILM	POLYESTER OR EQUAL	75	25
2	CONDUCTOR	CARBON PASTE OVER SILVER PASTE	10 MIN.	
3	OVERLAY	POLYIMIDE OR POLYESTER OR EQUAL	—	
4	SUPPORTING TAPE	POLYESTER OR POLYIMIDE OR EQUAL	188	250

NOTES

1. NO BURR AT EACH PORTION.
2. NO PEELING IN COMMON USE.
3. TOTAL THICKNESS LIMIT OF EACH MATERIAL (INCLUDING ADHESIVE AGENT) IS SPECIFIED.

mat'l. code				surface ISO 1302 <input checked="" type="checkbox"/>		tolerance ISO 406 <input checked="" type="checkbox"/>		projection		product family 58JF/TF		CODE JP	
litr ecn no dr date				tolerances unless otherwise specified		mm		title		RECOMMENDED CABLE		(Cat. No. SLW__R/S-5__)	
AA J05-0079 H.T. 2/18/05				angles linear		mm		scale X		dwg no		sheet 1 of 1 size	
AB J06-0459 H.T. 11/8/06						mm		FCI		JSA 92759		A4	
				dr		11/8/06				type		Product Customer Drawing	
				enr		11/8/06							
				chr		11/9/06							
				appd		11/9/06							
sheet index		revision sheet		AB 1								Rev. AB	

CAT. NO. & DIMENSIONS

NO. OF CONTACTS (n)	CAT. NO.		DIMENSIONS (NOTE1)	
	RIGHT ANGLE TYPE	STRAIGHT TYPE	A ± 0.3	B ± 0.3
4	SLW 4 R-5A7LF	SLW 4 S-5A7LF	10.2	5.2
5	SLW 5 R-5A7LF	SLW 5 S-5A7LF	11.2	6.2
6	SLW 6 R-5A7LF	SLW 6 S-5A7LF	12.2	7.2
7	SLW 7 R-5A7LF	SLW 7 S-5A7LF	13.2	8.2
8	SLW 8 R-5A7LF	SLW 8 S-5A7LF	14.2	9.2
9	SLW 9 R-5A7LF	SLW 9 S-5A7LF	15.2	10.2
10	SLW 10R-5A7LF	SLW 10S-5A7LF	16.2	11.2
11	SLW 11R-5A7LF	SLW 11S-5A7LF	17.2	12.2
12	SLW 12R-5A7LF	SLW 12S-5A7LF	18.2	13.2
13	SLW 13R-5A7LF	SLW 13S-5A7LF	19.2	14.2
14	SLW 14R-5A7LF	SLW 14S-5A7LF	20.2	15.2
15	SLW 15R-5A7LF	SLW 15S-5A7LF	21.2	16.2
16	SLW 16R-5A7LF	SLW 16S-5A7LF	22.2	17.2
17	SLW 17R-5A7LF	SLW 17S-5A7LF	23.2	18.2
18	SLW 18R-5A7LF	SLW 18S-5A7LF	24.2	19.2
19	SLW 19R-5A7LF	SLW 19S-5A7LF	25.2	20.2
20	SLW 20R-5A7LF	SLW 20S-5A7LF	26.2	21.2
21	SLW 21R-5A7LF	SLW 21S-5A7LF	27.2	22.2
22	SLW 22R-5A7LF	SLW 22S-5A7LF	28.2	23.2
23	SLW 23R-5A7LF	SLW 23S-5A7LF	29.2	24.2
24	SLW 24R-5A7LF	SLW 24S-5A7LF	30.2	25.2
25	SLW 25R-5A7LF	SLW 25S-5A7LF	31.2	26.2
26	SLW 26R-5A7LF	SLW 26S-5A7LF	32.2	27.2
27	SLW 27R-5A7LF	SLW 27S-5A7LF	33.2	28.2
28	SLW 28R-5A7LF	SLW 28S-5A7LF	34.2	29.2
29	SLW 29R-5A7LF	SLW 29S-5A7LF	35.2	30.2
30	SLW 30R-5A7LF	SLW 30S-5A7LF	36.2	31.2

CAT. NO. SLW (n) R -5A7 LF
 SERIES NAME _____
 NO. OF CONTACTS _____
 R:RIGHT ANGLE TYPE _____
 S:STRAIGHT TYPE _____
 VARIATION _____
 LEAD FREE _____

NOTE
 1. SEE PART DRAWINGS FOR DIMENSIONS A,B.

mat'l. code				surface ISO 1302 ✓	tolerance ISO 406 ISO 1101	projection	product family 5BJF/TF	CODE JP
ltr	ecn no	dr	date	tolerances unless otherwise specified		mm	title	
A	J05-0079	H.T	2/18/05	angles	linear		CAT NO. TABLE FOR 1mm SPACING CONNECTOR (Cat. No. SLW__R/S-5A7LF)	
B	J06-0459	H.T	11/8/06			scale X	dwg no JSA 96309 sheet 1 of 1 size A4	
				dr		FCI	type Product Customer Drawing	
				enr				
				chr				
				appd				
sheet index	revision sheet	B 1						Rev. B



FCIconnect.com

Copyright FCI.

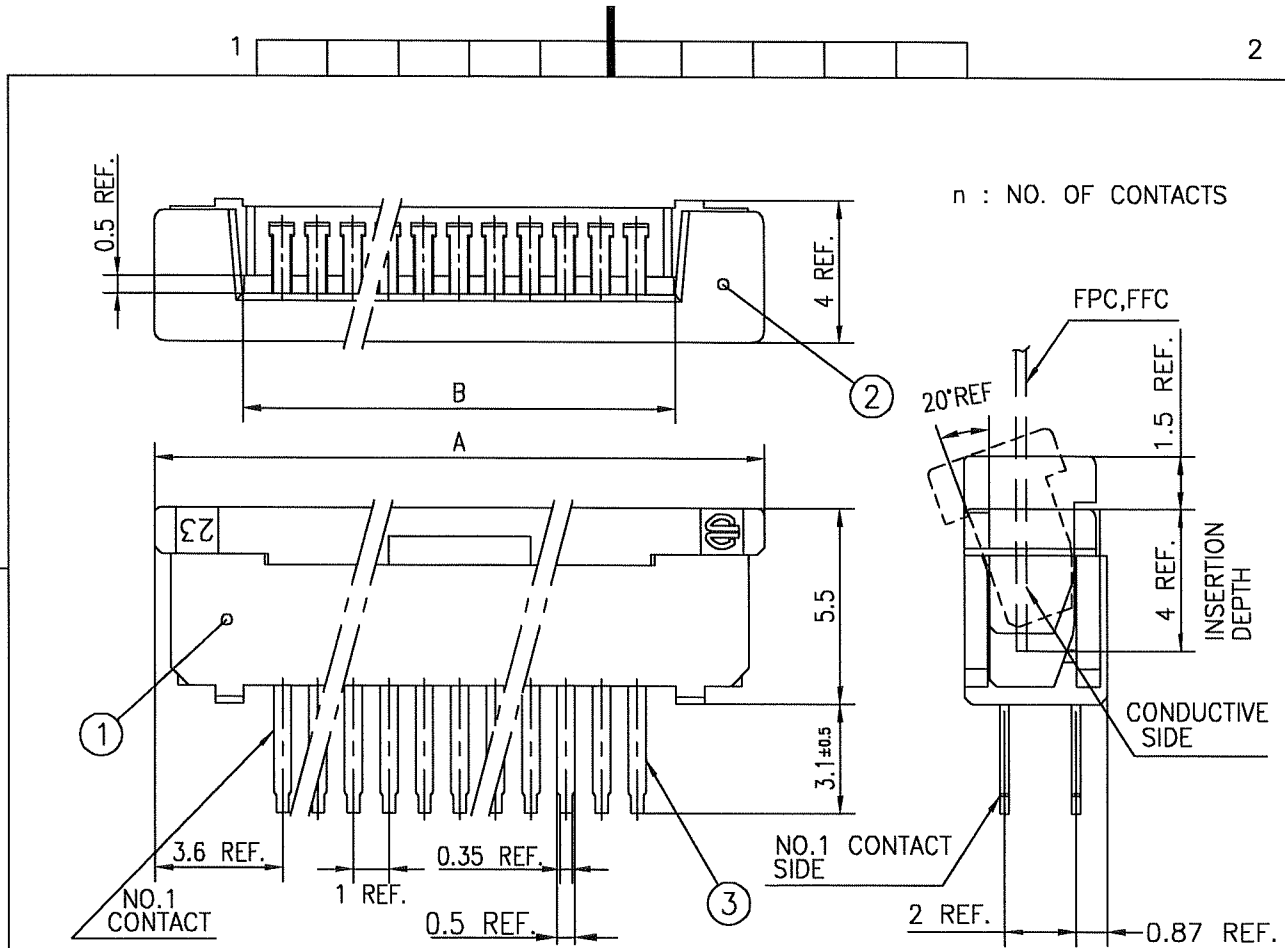

n : NO. OF CONTACTS

1. THIS PRODUCT MEETS EUROPEAN UNION DIRECTIVES AND OTHER COUNTRY REGULATIONS AS DESCRIBED IN GS-22-008

2. THE HOUSING WILL WITHSTAND EXPOSURE TO 260°C PEAK TEMPERATURE FOR 10 SECONDS IN A WAVE SOLDER APPLICATION WITH A 1.6mm THICK CIRCUIT BOARD.

PT.NO.	PARTS NAME	MATERIAL	Q'TY	NOTE
1	HOUSING	NYLON RESIN GLASS REINFORCED (UL94V-0)	1	COLOR : BLACK
2	SLIDER		1	
3	CONTACT	PHOSPHOR BRONZE	n	PLATING : MATTE PURE TIN (LEAD FREE)

RECOMMENDED PC BOARD THICKNESS : 0.8~1.6 HOLE PATTERN (COMPONENT SIDE)

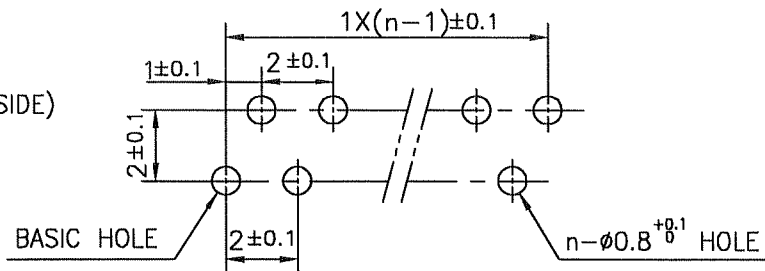

mat'l. code				surface ISO 1302 ✓		tolerance ISO 406 ISO 1101		projection		product family 58JF		CODE JP	
ltr	ecn no	dr	date	tolerances unless otherwise specified				mm		title			
A	J05-0079	H.T	2/18/05	± 0.3				mm		1mm SPACING CONNECTOR (Cat. No. SLW__S-5A7LF)			
B	J05-0734	H.T	10/28/05	angles linear				scale X		 dwg no JSA 96310 sheet 1 of 1 size A4 type Product Customer Drawing			
C	J06-0459	H.T	11/8/06										
				dr <i>H. Saito</i> 11/8/06									
				enr <i>H. Saito</i> 11/8/06									
				chr <i>R. Saito</i> 11/9/06									
				app <i>S. Saito</i> 11/9/06									
sheet index		revision sheet		C								Rev. C	

SC-SLW03 JSA96300 form: A4



1. THIS PRODUCT MEETS EUROPEAN UNION DIRECTIVES AND OTHER COUNTRY REGULATIONS AS DESCRIBED IN GS-22-008

2. THE HOUSING WILL WITHSTAND EXPOSURE TO 260°C PEAK TEMPERATURE FOR 10 SECONDS IN A WAVE SOLDER APPLICATION WITH A 1.6mm THICK CIRCUIT BOARD.

PT.NO.	PARTS NAME	MATERIAL	Q'TY	NOTE
1	HOUSING	NYLON RESIN GLASS REINFORCED (UL94V-0)	1	COLOR : BLACK
2	SLIDER		1	
3	CONTACT	PHOSPHOR BRONZE	n	PLATING : MATTE PURE TIN (LEAD FREE)

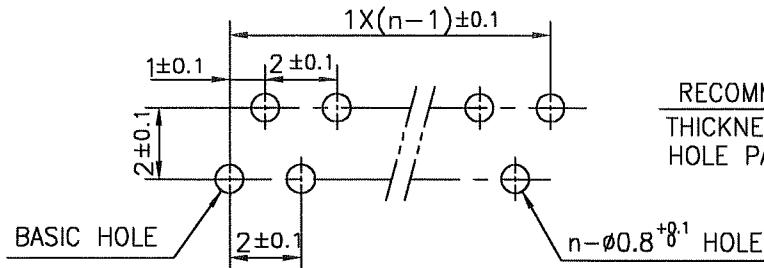

RECOMMENDED PC BOARD THICKNESS : 0.8~1.6 HOLE PATTERN (COMPONENT SIDE)

mat'l. code				surface ISO 1302 ✓		tolerance ISO 406 ISO 1101		projection		product family 58TF		CODE JP		
ltr	ecn no	dr	date	tolerances unless otherwise specified				mm		title				
A	J05-0079	H.T.	'05/2/18	angles		linear		scale X		1mm SPACING CONNECTOR (Cat. No. SLW__R-5A7LF)				
B	J05-0734	H.T.	10/28/'05							dwg no JSA 96311 sheet 1 of 1 size A4				
C	J06-0459	H.T.	11/8/'06							type Product Customer Drawing				
sheet index			revision C		dr		engr		chr		appd		Rev. C	

SC-SLW04 JSA96309 form: A4

RECOMMENDED CABLE (CIC)

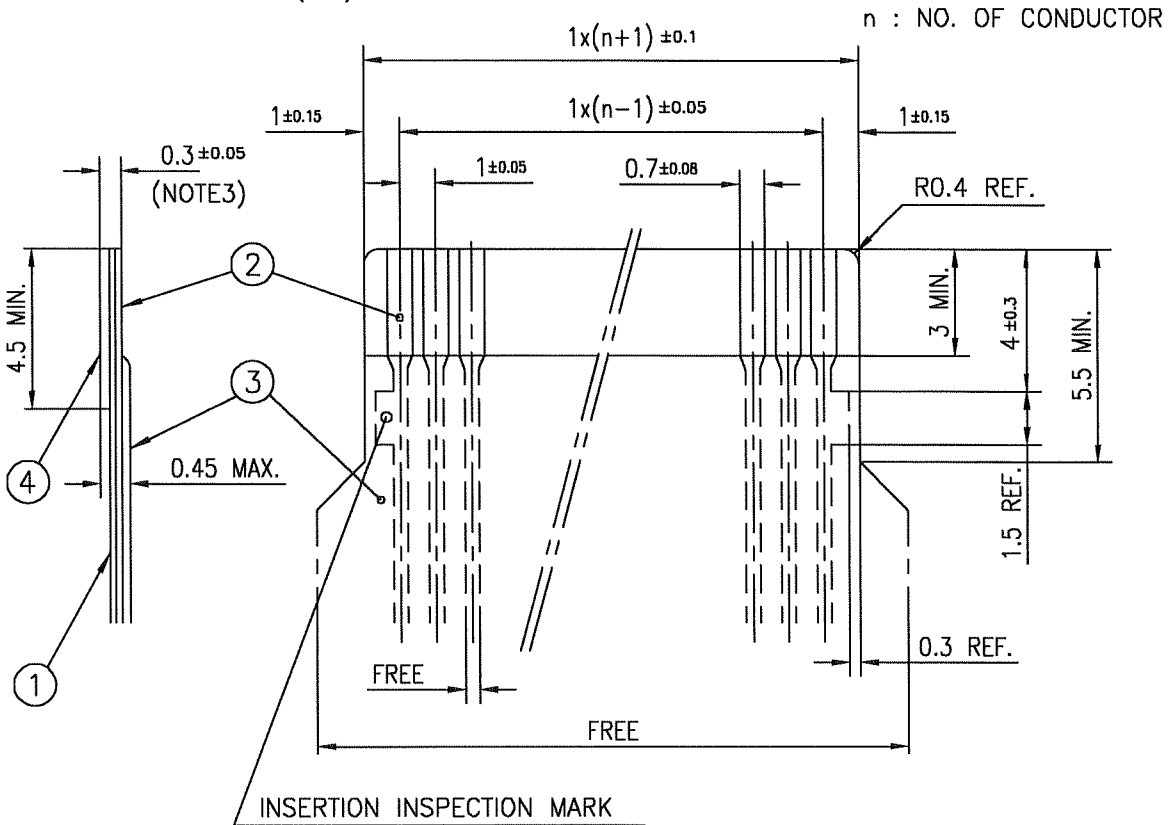

PT. NO.	PARTS NAME	MATERIAL	THICKNESS (μm)	
1	BASE FILM	POLYESTER OR EQUAL	75	25
2	CONDUCTOR	CARBON PASTE OVER SILVER PASTE	10 MIN.	
3	OVERLAY	POLYIMIDE OR POLYESTER OR EQUAL	—	
4	SUPPORTING TAPE	POLYESTER OR POLYIMIDE OR EQUAL	188	250

NOTES

1. NO BURR AT EACH PORTION.
2. NO PEELING IN COMMON USE.
3. TOTAL THICKNESS LIMIT OF EACH MATERIAL (INCLUDING ADHESIVE AGENT) IS SPECIFIED.

mat'l. code				surface ISO 1302 ✓		tolerance ISO 406 ISO 1101		projection		product family 58JF/TF		CODE JP	
litr ecn no dr date				tolerances unless otherwise specified				mm		title			
AA J05-0079 H.T. 2/18/05				angles linear				mm		RECOMMENDED CABLE (Cat. No. SLW__R/S-5__)			
AB J06-0459 H.T. 11/8/06								scale X		dwg no sheet 1 of 1 size			
				dr H. Shirota 11/8/06				FCJ		JSA 92759 A4			
				enr H. Shirota 11/8/06						type Product Customer Drawing			
				chr R. Shirota 11/9/06									
				appd S. Okamoto 11/9/06									
sheet index		revision sheet		AB 1								Rev. AB	



Компания «ЭлектроПласт» предлагает заключение долгосрочных отношений при поставках импортных электронных компонентов на взаимовыгодных условиях!

Наши преимущества:

- Оперативные поставки широкого спектра электронных компонентов отечественного и импортного производства напрямую от производителей и с крупнейших мировых складов;
- Поставка более 17-ти миллионов наименований электронных компонентов;
- Поставка сложных, дефицитных, либо снятых с производства позиций;
- Оперативные сроки поставки под заказ (от 5 рабочих дней);
- Экспресс доставка в любую точку России;
- Техническая поддержка проекта, помощь в подборе аналогов, поставка прототипов;
- Система менеджмента качества сертифицирована по Международному стандарту ISO 9001;
- Лицензия ФСБ на осуществление работ с использованием сведений, составляющих государственную тайну;
- Поставка специализированных компонентов (Xilinx, Altera, Analog Devices, Intersil, Interpoint, Microsemi, Aeroflex, Peregrine, Syfer, Eurofarad, Texas Instrument, Miteq, Cobham, E2V, MA-COM, Hittite, Mini-Circuits, General Dynamics и др.);

Помимо этого, одним из направлений компании «ЭлектроПласт» является направление «Источники питания». Мы предлагаем Вам помощь Конструкторского отдела:

- Подбор оптимального решения, техническое обоснование при выборе компонента;
- Подбор аналогов;
- Консультации по применению компонента;
- Поставка образцов и прототипов;
- Техническая поддержка проекта;
- Защита от снятия компонента с производства.



Как с нами связаться

Телефон: 8 (812) 309 58 32 (многоканальный)

Факс: 8 (812) 320-02-42

Электронная почта: org@eplast1.ru

Адрес: 198099, г. Санкт-Петербург, ул. Калинина, дом 2, корпус 4, литера А.