



FCIconnect.com

Copyright FCI.

1

2

Configuration of customer Documents list

| P/N | Documents | No. | Title |
|----------------|-----------|----------|---|
| SLW__R/S-5C7LF | SPEC | SC-SLW04 | |
| | DWG | JSA96303 | CAT NO. TABLE FOR 1mm SPACING CONNECTOR |
| | | JSA96304 | 1mm SPACING CONNECTOR |
| | | JSA96305 | 1mm SPACING CONNECTOR |
| | Cable | JSA92759 | RECOMMENDED CABLE (CIC) |

| P/N | Documents | No. | Title |
|----------------|-----------|----------|---|
| SLW__R/S-5A7LF | SPEC | SC-SLW04 | |
| | DWG | JSA96309 | CAT NO. TABLE FOR 1mm SPACING CONNECTOR |
| | | JSA96310 | 1mm SPACING CONNECTOR |
| | | JSA96311 | 1mm SPACING CONNECTOR |
| | Cable | JSA92759 | RECOMMENDED CABLE (CIC) |

| | | | | | | | | | | | | | |
|-------------|----------------|-----|----------|--|------------------|---|--|------------|----------|---|--------------------------|---------|------|
| mat'l. code | | | | surface ISO 1302 <input checked="" type="checkbox"/> | | tolerance ISO 406 <input checked="" type="checkbox"/> ISO 1101 | | projection | | product family 58JF/TF | | CODE JP | |
| ltr | ecn no | dr | date | tolerances unless otherwise specified | | | | mm | | title 1mm SPACING CONNECTOR DOCUMENT LIST (Cat. No. SLW__R/S-5__LF) | | | |
| A | J05-0079 | H.T | '05/2/18 | angles | linear | scale \propto | | | | | | | |
| B | J06-0459 | H.T | 11/8/06 | dr | <i>K. Shouji</i> | <i>11/8/06</i> | | | dwg no | | sheet 1 of 1 | | size |
| | | | | enr | <i>K. Shouji</i> | <i>11/8/06</i> | | | JSA96342 | | A4 | | |
| | | | | chr | <i>R. Shouji</i> | <i>11/9/06</i> | | | type | | Product Customer Drawing | | |
| | | | | app | <i>S. Adachi</i> | <i>11/9/06</i> | | | | | | | |
| sheet index | revision sheet | B | 1 | | | | | | | | | Rev. B | |

form: A4

1

2

CAT. NO. & DIMENSIONS

| NO. OF CONTACTS (n) | CAT. NO. | | DIMENSIONS (NOTE1) | |
|---------------------|------------------|---------------|--------------------|---------|
| | RIGHT ANGLE TYPE | STRAIGHT TYPE | A ± 0.3 | B ± 0.3 |
| 4 | SLW 4 R-5C7LF | SLW 4 S-5C7LF | 10.2 | 5.2 |
| 5 | SLW 5 R-5C7LF | SLW 5 S-5C7LF | 11.2 | 6.2 |
| 6 | SLW 6 R-5C7LF | SLW 6 S-5C7LF | 12.2 | 7.2 |
| 7 | SLW 7 R-5C7LF | SLW 7 S-5C7LF | 13.2 | 8.2 |
| 8 | SLW 8 R-5C7LF | SLW 8 S-5C7LF | 14.2 | 9.2 |
| 9 | SLW 9 R-5C7LF | SLW 9 S-5C7LF | 15.2 | 10.2 |
| 10 | SLW 10 R-5C7LF | SLW 10S-5C7LF | 16.2 | 11.2 |
| 11 | SLW 11 R-5C7LF | SLW 11S-5C7LF | 17.2 | 12.2 |
| 12 | SLW 12 R-5C7LF | SLW 12S-5C7LF | 18.2 | 13.2 |
| 13 | SLW 13 R-5C7LF | SLW 13S-5C7LF | 19.2 | 14.2 |
| 14 | SLW 14 R-5C7LF | SLW 14S-5C7LF | 20.2 | 15.2 |
| 15 | SLW 15 R-5C7LF | SLW 15S-5C7LF | 21.2 | 16.2 |
| 16 | SLW 16 R-5C7LF | SLW 16S-5C7LF | 22.2 | 17.2 |
| 17 | SLW 17 R-5C7LF | SLW 17S-5C7LF | 23.2 | 18.2 |
| 18 | SLW 18 R-5C7LF | SLW 18S-5C7LF | 24.2 | 19.2 |
| 19 | SLW 19 R-5C7LF | SLW 19S-5C7LF | 25.2 | 20.2 |
| 20 | SLW 20 R-5C7LF | SLW 20S-5C7LF | 26.2 | 21.2 |
| 21 | SLW 21 R-5C7LF | SLW 21S-5C7LF | 27.2 | 22.2 |
| 22 | SLW 22 R-5C7LF | SLW 22S-5C7LF | 28.2 | 23.2 |
| 23 | SLW 23 R-5C7LF | SLW 23S-5C7LF | 29.2 | 24.2 |
| 24 | SLW 24 R-5C7LF | SLW 24S-5C7LF | 30.2 | 25.2 |
| 25 | SLW 25 R-5C7LF | SLW 25S-5C7LF | 31.2 | 26.2 |
| 26 | SLW 26 R-5C7LF | SLW 26S-5C7LF | 32.2 | 27.2 |
| 27 | SLW 27 R-5C7LF | SLW 27S-5C7LF | 33.2 | 28.2 |
| 28 | SLW 28 R-5C7LF | SLW 28S-5C7LF | 34.2 | 29.2 |
| 29 | SLW 29 R-5C7LF | SLW 29S-5C7LF | 35.2 | 30.2 |
| 30 | SLW 30 R-5C7LF | SLW 30S-5C7LF | 36.2 | 31.2 |

CAT. NO. SLW (n) R - 5C7 LF NOTE

SERIES NAME _____
 NO. OF CONTACTS _____
 R:RIGHT ANGLE TYPE
 S:STRAIGHT TYPE
 VARIATION _____
 LEAD FREE _____

1. SEE PART DRAWINGS FOR DIMENSIONS A,B.

| | | | | | | | | |
|-------------|----------------|-----|----------|--|----------------------------|----------------|---|---------|
| mat'l. code | | | | surface ISO 1302 <input checked="" type="checkbox"/> | tolerance ISO 406 ISO 1101 | projection | product family 58JF/TF | CODE JP |
| ltr | ecn no | dr | date | tolerances unless otherwise specified | | mm | title | |
| A | J05-0079 | H.T | '05/2/15 | angles | linear | | CAT NO. TABLE FOR 1mm SPACING CONNECTOR (Cat. No. SLW__R/S-5C7LF) | |
| B | J06-0459 | H.T | 11/8/'06 | | | scale \times | dwg no sheet 1 of 1 size | |
| | | | | dr | <i>H. J. J. 11/8/06</i> | | JSA 96303 A4 | |
| | | | | enr | <i>H. J. J. 11/8/06</i> | | type Product Customer Drawing | |
| | | | | chr | <i>R. Shoupe 11/9/06</i> | | | |
| | | | | app | <i>S. J. J. 11/9/06</i> | | | |
| sheet index | revision sheet | B 1 | | | | | | Rev. B |

SC-SLW04 JSA96304 96305 92759 form: A4



FCIconnect.com

Copyright FCI.

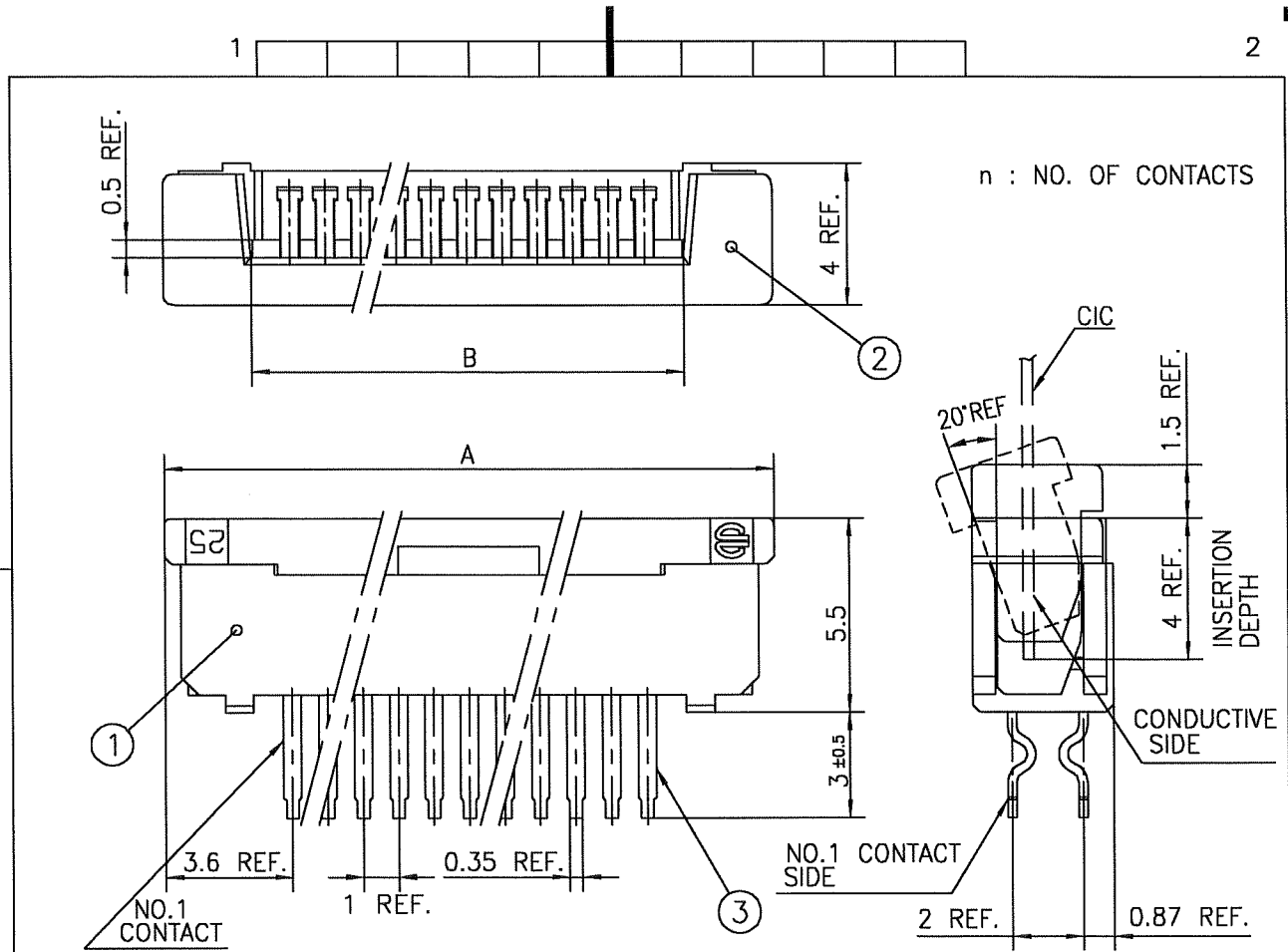

n : NO. OF CONTACTS

| PT.NO. | PARTS NAME | MATERIAL | Q'TY | NOTE |
|--------|------------|--|------|--------------------------------------|
| 1 | HOUSING | NYLON RESIN GLASS REINFORCED (UL94V-0) | 1 | COLOR : BLACK |
| 2 | SLIDER | | 1 | COLOR : WHITE |
| 3 | CONTACT | PHOSPHOR BRONZE | n | PLATING : MATTE PURE TIN (LEAD FREE) |

RECOMMENDED PC BOARD
 THICKNESS : 0.8~1.6
 HOLE PATTERN (COMPONENT SIDE)

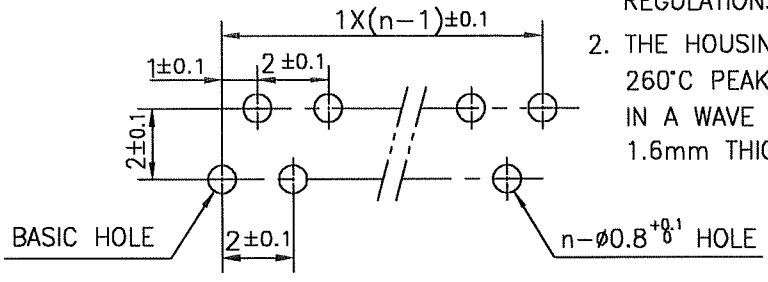

1. THIS PRODUCT MEETS EUROPEAN UNION DIRECTIVES AND OTHER COUNTRY REGULATIONS AS DESCRIBED IN GS-22-008
2. THE HOUSING WILL WITHSTAND EXPOSURE TO 260°C PEAK TEMPERATURE FOR 10 SECONDS IN A WAVE SOLDER APPLICATION WITH A 1.6mm THICK CIRCUIT BOARD.

| | | | | | | | | | | | | | | | |
|---------------------------|--|----------------|--|---------------------------------------|--|----------------------------|--|------------|--|---|--|--------------------------|--|--|--|
| mat'l. code | | | | surface ISO 1302 ✓ | | tolerance ISO 406 ISO 1101 | | projection | | product family 58JF | | CODE JP | | | |
| litr ecn no dr date | | | | tolerances unless otherwise specified | | ± 0.3 | | mm | | title | | | | | |
| A J05-0079 H.T. '05/2/15 | | | | angles linear | | | | scale X | | 1mm SPACING CONNECTOR (Cat. No. SLW__S-5C7LF) | | | | | |
| B J05-0734 H.T. 10/28/'05 | | | | | | | | | | dwg no | | sheet 1 of 1 size | | | |
| C J06-0459 H.T. 11/8/'06 | | | | dr | | 11/2/06 | | FCJ | | JSA 96304 | | A4 | | | |
| | | | | enrg | | 11/2/06 | | | | type | | Product Customer Drawing | | | |
| | | | | chr | | 11/9/06 | | | | | | | | | |
| | | | | appd | | 11/9/06 | | | | | | | | | |
| sheet index | | revision sheet | | C 1 | | | | | | | | Rev. c | | | |

SC-SLW04 JSA96303 form: A4



n : NO. OF CONTACTS

| PT.NO. | PARTS NAME | MATERIAL | Q'TY | NOTE |
|--------|------------|------------------------------|------|--------------------------------------|
| 1 | HOUSING | NYLON RESIN GLASS REINFORCED | 1 | COLOR : BLACK |
| 2 | SLIDER | (UL94V-0) | 1 | COLOR : WHITE |
| 3 | CONTACT | PHOSPHOR BRONZE | n | PLATING : MATTE PURE TIN (LEAD FREE) |

RECOMMENDED PC BOARD
 THICKNESS : 0.8~1.6
 HOLE PATTERN (COMPONENT SIDE)



1. THIS PRODUCT MEETS EUROPEAN UNION DIRECTIVES AND OTHER COUNTRY REGULATIONS AS DESCRIBED IN GS-22-008
2. THE HOUSING WILL WITHSTAND EXPOSURE TO 260°C PEAK TEMPERATURE FOR 10 SECONDS IN A WAVE SOLDER APPLICATION WITH A 1.6mm THICK CIRCUIT BOARD.

| | | | | | | | | | | | | | |
|-------------------------|--|----------------|--|---------------------------------------|--|----------------------------|--|------------|--|-------------------------------|--|-------------------|--|
| mat'l. code | | | | surface ISO 1302 ✓ | | tolerance ISO 406 ISO 1101 | | projection | | product family 58TF | | CODE JP | |
| litr ecn no dr date | | | | tolerances unless otherwise specified | | angles linear | | mm | | title | | | |
| A J05-0079 H.T '05/2/15 | | | | | | | | | | 1mm SPACING CONNECTOR | | | |
| B J05-0734 H.T 10/28/05 | | | | | | | | | | (Cat. No. SLW__R-5C7LF) | | | |
| C J06-0459 H.T 11/8/06 | | | | | | | | | | | | | |
| | | | | dr | | 11/8/06 | | | | dwg no | | sheet 1 of 1 size | |
| | | | | enrg | | 11/8/06 | | | | JSA 96305 | | A4 | |
| | | | | chr | | 11/9/06 | | | | | | | |
| | | | | appd | | 11/9/06 | | | | type Product Customer Drawing | | | |
| sheet index | | revision sheet | | C | | 1 | | | | | | Rev. C | |

SC-SLW04 JSA96303
form: A4

RECOMMENDED CABLE (CIC)

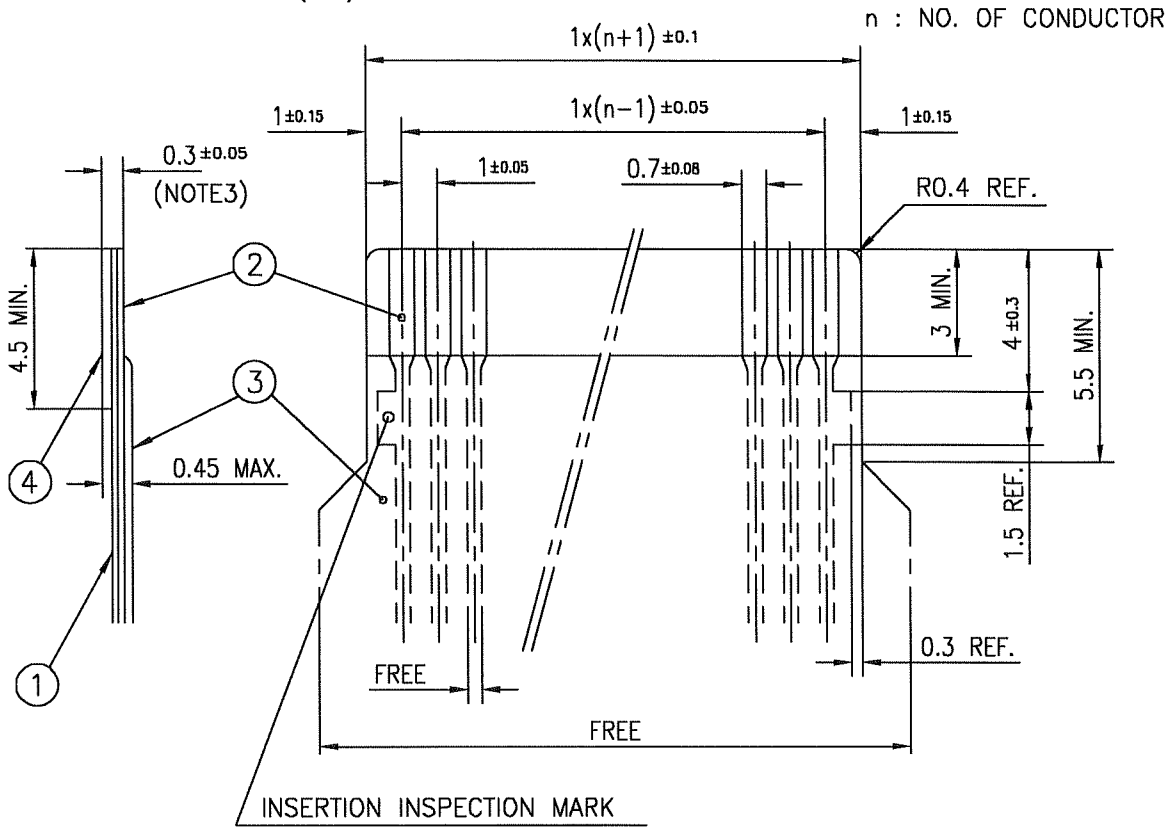

| PT. NO. | PARTS NAME | MATERIAL | THICKNESS (μm) | |
|---------|-----------------|---------------------------------|----------------|-----|
| 1 | BASE FILM | POLYESTER OR EQUAL | 75 | 25 |
| 2 | CONDUCTOR | CARBON PASTE OVER SILVER PASTE | 10 MIN. | |
| 3 | OVERLAY | POLYIMIDE OR POLYESTER OR EQUAL | — | |
| 4 | SUPPORTING TAPE | POLYESTER OR POLYIMIDE OR EQUAL | 188 | 250 |

NOTES

1. NO BURR AT EACH PORTION.
2. NO PEELING IN COMMON USE.
3. TOTAL THICKNESS LIMIT OF EACH MATERIAL (INCLUDING ADHESIVE AGENT) IS SPECIFIED.

| | | | | | | | | | | | | | |
|-------------|----------|----------------|---------|---------------------------------------|--|----------------------------------|--|-----------------|--|---|--|--------------------------|--|
| mat'l. code | | | | surface ISO 1302 ✓ | | tolerance ISO 406 ISO 1101 | | projection ⊕ | | product family 58JF/TF | | CODE JP | |
| ltr | ecn no | dr | date | tolerances unless otherwise specified | | | | mm | | title RECOMMENDED CABLE (Cat. No. SLW__R/S-5__) | | | |
| AA | J05-0079 | H.T | 2/18/05 | angles | | linear | | scale X | | dwg no | | sheet 1 of 1 size | |
| AB | J06-0459 | H.T | 11/8/06 | | | | | FCJ | | JSA 92759 | | A4 | |
| | | | | dr | | 11/8/06 | | | | type | | Product Customer Drawing | |
| | | | | enr | | 11/8/06 | | | | | | | |
| | | | | chr | | 11/9/06 | | | | | | | |
| | | | | appd | | 11/9/06 | | | | | | | |
| sheet index | | revision sheet | | AB | | 1 | | | | | | Rev. AB | |

CAT. NO. & DIMENSIONS

| NO. OF CONTACTS (n) | CAT. NO. | | DIMENSIONS (NOTE1) | |
|---------------------|------------------|---------------|--------------------|---------|
| | RIGHT ANGLE TYPE | STRAIGHT TYPE | A ± 0.3 | B ± 0.3 |
| 4 | SLW 4 R-5A7LF | SLW 4 S-5A7LF | 10.2 | 5.2 |
| 5 | SLW 5 R-5A7LF | SLW 5 S-5A7LF | 11.2 | 6.2 |
| 6 | SLW 6 R-5A7LF | SLW 6 S-5A7LF | 12.2 | 7.2 |
| 7 | SLW 7 R-5A7LF | SLW 7 S-5A7LF | 13.2 | 8.2 |
| 8 | SLW 8 R-5A7LF | SLW 8 S-5A7LF | 14.2 | 9.2 |
| 9 | SLW 9 R-5A7LF | SLW 9 S-5A7LF | 15.2 | 10.2 |
| 10 | SLW 10R-5A7LF | SLW 10S-5A7LF | 16.2 | 11.2 |
| 11 | SLW 11R-5A7LF | SLW 11S-5A7LF | 17.2 | 12.2 |
| 12 | SLW 12R-5A7LF | SLW 12S-5A7LF | 18.2 | 13.2 |
| 13 | SLW 13R-5A7LF | SLW 13S-5A7LF | 19.2 | 14.2 |
| 14 | SLW 14R-5A7LF | SLW 14S-5A7LF | 20.2 | 15.2 |
| 15 | SLW 15R-5A7LF | SLW 15S-5A7LF | 21.2 | 16.2 |
| 16 | SLW 16R-5A7LF | SLW 16S-5A7LF | 22.2 | 17.2 |
| 17 | SLW 17R-5A7LF | SLW 17S-5A7LF | 23.2 | 18.2 |
| 18 | SLW 18R-5A7LF | SLW 18S-5A7LF | 24.2 | 19.2 |
| 19 | SLW 19R-5A7LF | SLW 19S-5A7LF | 25.2 | 20.2 |
| 20 | SLW 20R-5A7LF | SLW 20S-5A7LF | 26.2 | 21.2 |
| 21 | SLW 21R-5A7LF | SLW 21S-5A7LF | 27.2 | 22.2 |
| 22 | SLW 22R-5A7LF | SLW 22S-5A7LF | 28.2 | 23.2 |
| 23 | SLW 23R-5A7LF | SLW 23S-5A7LF | 29.2 | 24.2 |
| 24 | SLW 24R-5A7LF | SLW 24S-5A7LF | 30.2 | 25.2 |
| 25 | SLW 25R-5A7LF | SLW 25S-5A7LF | 31.2 | 26.2 |
| 26 | SLW 26R-5A7LF | SLW 26S-5A7LF | 32.2 | 27.2 |
| 27 | SLW 27R-5A7LF | SLW 27S-5A7LF | 33.2 | 28.2 |
| 28 | SLW 28R-5A7LF | SLW 28S-5A7LF | 34.2 | 29.2 |
| 29 | SLW 29R-5A7LF | SLW 29S-5A7LF | 35.2 | 30.2 |
| 30 | SLW 30R-5A7LF | SLW 30S-5A7LF | 36.2 | 31.2 |

CAT. NO. SLW (n) R -5A7 LF

SERIES NAME _____

NO. OF CONTACTS _____



R:RIGHT ANGLE TYPE _____

S:STRAIGHT TYPE _____

VARIATION _____

LEAD FREE _____

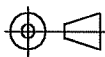
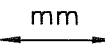
NOTE
1. SEE PART DRAWINGS FOR DIMENSIONS A,B.

| | | | | | | | | | | | |
|-------------|--|----------------|--|---|--|--|--|--|--|---|--|
| mat'l. code | | | | surface <input checked="" type="checkbox"/> ISO 1302 <input checked="" type="checkbox"/> tolerance <input checked="" type="checkbox"/> ISO 406 <input checked="" type="checkbox"/> ISO 1101 | | projection  | | product family 5BJF/TF | | CODE JP | |
| ltr | | ecn no | | dr | | date | | tolerances unless otherwise specified | | title | |
| A | | J05-0079 | | H.T. | | 2/18/05 | | angles linear | | CAT NO. TABLE FOR 1mm SPACING CONNECTOR (Cat. No. SLW__R/S-5A7LF) | |
| B | | J06-0459 | | H.T. | | 11/8/06 | | mm  | | scale \times | |
| | | | | dr <i>[Signature]</i> 11/8/06 | | | |  | | dwg no sheet 1 of 1 size | |
| | | | | enrg <i>[Signature]</i> 11/8/06 | | | | | | JSA 96309 A4 | |
| | | | | chr <i>[Signature]</i> 11/9/06 | | | | | | type Product Customer Drawing | |
| | | | | appd <i>[Signature]</i> 11/9/06 | | | | | | | |
| sheet index | | revision sheet | | B 1 | | | | | | Rev. B | |



FCIconnect.com

Copyright FCI.



1. THIS PRODUCT MEETS EUROPEAN UNION DIRECTIVES AND OTHER COUNTRY REGULATIONS AS DESCRIBED IN GS-22-008

2. THE HOUSING WILL WITHSTAND EXPOSURE TO 260°C PEAK TEMPERATURE FOR 10 SECONDS IN A WAVE SOLDER APPLICATION WITH A 1.6mm THICK CIRCUIT BOARD.

| PT.NO. | PARTS NAME | MATERIAL | Q'TY | NOTE |
|--------|------------|--|------|--------------------------------------|
| 1 | HOUSING | NYLON RESIN GLASS REINFORCED (UL94V-0) | 1 | COLOR : BLACK |
| 2 | SLIDER | | 1 | |
| 3 | CONTACT | PHOSPHOR BRONZE | n | PLATING : MATTE PURE TIN (LEAD FREE) |

RECOMMENDED PC BOARD THICKNESS : 0.8~1.6 HOLE PATTERN (COMPONENT SIDE)

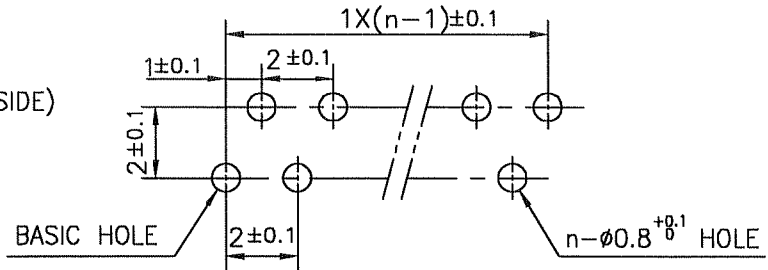

| | | | | | | | | | | | | | |
|-------------|----------|----------------|----------|---------------------------------------|--|----------------------------|--|------------|--|---|--|---------|--|
| mat'l. code | | | | surface ISO 1302 ✓ | | tolerance ISO 406 ISO 1101 | | projection | | product family 58JF | | CODE JP | |
| ltr | ecn no | dr | date | tolerances unless otherwise specified | | | | mm | | title | | | |
| A | J05-0079 | H.T | 2/18/05 | ± 0.3 | | | | mm | | 1mm SPACING CONNECTOR (Cat. No. SLW__S-5A7LF) | | | |
| B | J05-0734 | H.T | 10/28/05 | angles linear | | | | scale X | | FCI dwg no JSA 96310 sheet 1 of 1 size A4 type Product Customer Drawing | | | |
| C | J06-0459 | H.T | 11/8/06 | | | | | | | | | | |
| | | | | dr | | | | | | | | | |
| | | | | enr | | | | | | | | | |
| | | | | chr | | | | | | | | | |
| | | | | appd | | | | | | | | | |
| sheet index | | revision sheet | | c | | | | | | | | Rev. c | |



1. THIS PRODUCT MEETS EUROPEAN UNION DIRECTIVES AND OTHER COUNTRY REGULATIONS AS DESCRIBED IN GS-22-008

2. THE HOUSING WILL WITHSTAND EXPOSURE TO 260°C PEAK TEMPERATURE FOR 10 SECONDS IN A WAVE SOLDER APPLICATION WITH A 1.6mm THICK CIRCUIT BOARD.

| PT.NO. | PARTS NAME | MATERIAL | Q'TY | NOTE |
|--------|------------|--|------|--------------------------------------|
| 1 | HOUSING | NYLON RESIN GLASS REINFORCED (UL94V-0) | 1 | COLOR : BLACK |
| 2 | SLIDER | | 1 | |
| 3 | CONTACT | PHOSPHOR BRONZE | n | PLATING : MATTE PURE TIN (LEAD FREE) |



RECOMMENDED PC BOARD THICKNESS : 0.8~1.6 HOLE PATTERN (COMPONENT SIDE)

| | | | | | | | | | | | | | |
|-------------|----------|----------------|-----------|---------------------------------------|--|----------------------------|--|------------|--|---|--|---------|--|
| mat'l. code | | | | surface ISO 1302 ✓ | | tolerance ISO 406 ISO 1101 | | projection | | product family 58TF | | CODE JP | |
| ltr | ecn no | dr | date | tolerances unless otherwise specified | | | | mm | | title | | | |
| A | J05-0079 | H.T. | '05/2/18 | angles | | linear | | scale X | | 1mm SPACING CONNECTOR (Cat. No. SLW__R-5A7LF) | | | |
| B | J05-0734 | H.T. | 10/28/'05 | | | | | | | dwg no sheet 1 of 1 size | | | |
| C | J06-0459 | H.T. | 11/8/'06 | | | | | | | JSA 96311 A4 | | | |
| | | | | dr | | 11/01/06 | | FCJ | | type Product Customer Drawing | | | |
| | | | | enr | | 11/01/06 | | | | | | | |
| | | | | chr | | 11/9/06 | | | | | | | |
| | | | | appd | | 11/9/06 | | | | | | | |
| sheet index | | revision sheet | | C | | 1 | | | | | | Rev. C | |

SC-SLW04 JSA96309 form: A4

RECOMMENDED CABLE (CIC)



| PT. NO. | PARTS NAME | MATERIAL | THICKNESS (μm) | |
|---------|-----------------|---------------------------------|-----------------------------|-----|
| 1 | BASE FILM | POLYESTER OR EQUAL | 75 | 25 |
| 2 | CONDUCTOR | CARBON PASTE OVER SILVER PASTE | 10 MIN. | |
| 3 | OVERLAY | POLYIMIDE OR POLYESTER OR EQUAL | — | |
| 4 | SUPPORTING TAPE | POLYESTER OR POLYIMIDE OR EQUAL | 188 | 250 |

NOTES

1. NO BURR AT EACH PORTION.
2. NO PEELING IN COMMON USE.
3. TOTAL THICKNESS LIMIT OF EACH MATERIAL (INCLUDING ADHESIVE AGENT) IS SPECIFIED.

| | | | | | | | | | | | | |
|-------------|----------|----------------|---------|---|--------|------------|--|-------------------------------|--|--------------------------|--|--|
| mat'l. code | | | | surface <input checked="" type="checkbox"/> ISO 1302 <input type="checkbox"/> tolerance <input checked="" type="checkbox"/> ISO 406 <input type="checkbox"/> ISO 1101 | | projection | | product family 58JF/TF | | CODE JP | | |
| ltr | ecn no | dr | date | tolerances unless otherwise specified | | | | title | | | | |
| AA | J05-0079 | H.T | 2/18/05 | | | | | RECOMMENDED CABLE | | | | |
| AB | J06-0459 | H.T | 11/8/06 | angles | linear | mm | | (Cat. No. SLW__R/S-5__) | | | | |
| | | | | | | | | scale \times | | dwg no sheet 1 of 1 size | | |
| | | | | | | | | | | JSA 92759 A4 | | |
| | | | | dr <i>H. Shouji</i> 11/8/06 | | | | type Product Customer Drawing | | | | |
| | | | | enr <i>H. Shouji</i> 11/8/06 | | | | | | | | |
| | | | | chr <i>R. Shouji</i> 11/9/06 | | | | | | | | |
| | | | | appd <i>S. Okamoto</i> 11/9/06 | | | | | | | | |
| sheet index | | revision sheet | | AB 1 | | | | | | Rev. AB | | |



Компания «ЭлектроПласт» предлагает заключение долгосрочных отношений при поставках импортных электронных компонентов на взаимовыгодных условиях!

Наши преимущества:

- Оперативные поставки широкого спектра электронных компонентов отечественного и импортного производства напрямую от производителей и с крупнейших мировых складов;
- Поставка более 17-ти миллионов наименований электронных компонентов;
- Поставка сложных, дефицитных, либо снятых с производства позиций;
- Оперативные сроки поставки под заказ (от 5 рабочих дней);
- Экспресс доставка в любую точку России;
- Техническая поддержка проекта, помощь в подборе аналогов, поставка прототипов;
- Система менеджмента качества сертифицирована по Международному стандарту ISO 9001;
- Лицензия ФСБ на осуществление работ с использованием сведений, составляющих государственную тайну;
- Поставка специализированных компонентов (Xilinx, Altera, Analog Devices, Intersil, Interpoint, Microsemi, Aeroflex, Peregrine, Syfer, Eurofarad, Texas Instrument, Miteq, Cobham, E2V, MA-COM, Hittite, Mini-Circuits, General Dynamics и др.);

Помимо этого, одним из направлений компании «ЭлектроПласт» является направление «Источники питания». Мы предлагаем Вам помощь Конструкторского отдела:

- Подбор оптимального решения, техническое обоснование при выборе компонента;
- Подбор аналогов;
- Консультации по применению компонента;
- Поставка образцов и прототипов;
- Техническая поддержка проекта;
- Защита от снятия компонента с производства.



Как с нами связаться

Телефон: 8 (812) 309 58 32 (многоканальный)

Факс: 8 (812) 320-02-42

Электронная почта: org@eplast1.ru

Адрес: 198099, г. Санкт-Петербург, ул. Калинина, дом 2, корпус 4, литера А.