

10A, 600V - 1000V Glass Passivated Single-Phase Bridge Rectifiers

FEATURES

- Thin Single in-line low profile package ideal for compact required circuit
- Glass passivated junction
- High surge current capability
- UL Recognized File # E-326243
- Compliant to RoHS Directive 2011/65/EU and in accordance to WEEE 2002/96/EC
- Halogen-free according to IEC 61249-2-21



MECHANICAL DATA

Case: KBJL

Molding compound, UL flammability classification rating 94V-0

Part no. with suffix "H" means AEC-Q101 qualified

Packing code with suffix "G" means green compound (halogen-free)

Terminal: Matte tin plated leads, solderable per JESD22-B102

Meet JESD 201 class 2 whisker test

Polarity: As marked

Mounting torque: 0.56 Nm max. (5 in-lbs. max.)

Weight: 2.5g (approximately)

KBJL

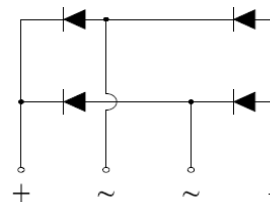

MAXIMUM RATINGS AND ELECTRICAL CHARACTERISTICS (T _J =25°C unless otherwise noted)					
PARAMETER	SYMBOL	TS10KL60	TS10KL80	TS10KL100	UNIT
Maximum repetitive peak reverse voltage	V _{RRM}	600	800	1000	V
Maximum RMS voltage	V _{RMS}	420	560	700	V
Maximum DC blocking voltage	V _{DC}	600	800	1000	V
Maximum average forward rectified current	I _{F(AV)}	10			A
Peak forward surge current, 8.3 ms single half sine-wave superimposed on rated load	I _{FSM}	180			A
Rating of fusing (t<8.3ms)	I ² t	134			A ² s
Maximum instantaneous forward voltage (Note 1) I _F = 5 A	V _F	1.0			V
Maximum reverse current @ rated V _R T _J =25 °C T _J =100 °C	I _R	5 150			μA
Typical thermal resistance (Note 2)	R _{θJC}	1.5			°C/W
Operating junction temperature range	T _J	- 55 to +150			°C
Storage temperature range	T _{STG}	- 55 to +150			°C

Note 1: Pulse test with PW=300 μs, 1% duty cycle

Note 2: Mount on Heatsink size of 4" x 6" x 0.25" Al-Plate

ORDERING INFORMATION

PART NO.	PART NO. SUFFIX	PACKING CODE	PACKING CODE SUFFIX (*)	PACKAGE	PACKING
TS10KLXX (Note 1)	H	D3	G	KBJL	20 / TUBE

Note 1: "xx" defines voltage from 600V (TS10KL60) to 1000V (TS10KL100)

*: Optional available

EXAMPLE

PREFERRED P/N	PART NO.	PART NO. SUFFIX	PACKING CODE	PACKING CODE SUFFIX	DESCRIPTION
TS10KL80HD3G	TS10KL80	H	D3	G	AEC-Q101 qualified Green compound

RATINGS AND CHARACTERISTICS CURVES

(T_A=25°C unless otherwise noted)

FIG.1 FORWARD CURRENT DERATING CURVE

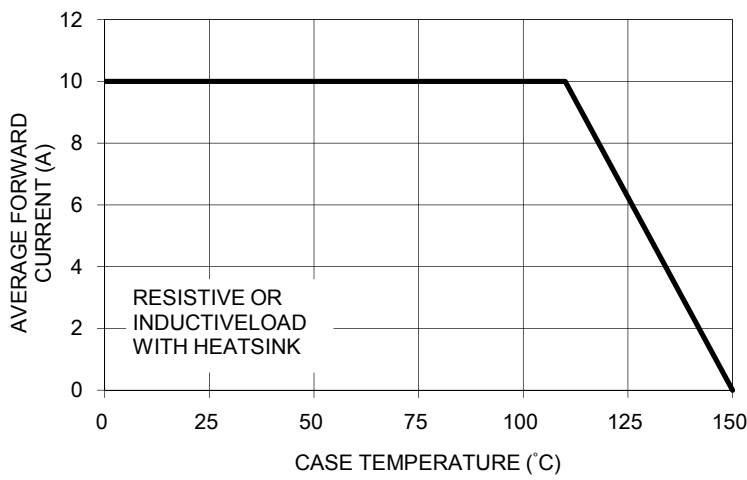

FIG. 2 MAXIMUM NON-REPETITIVE FORWARD SURGE CURRENT

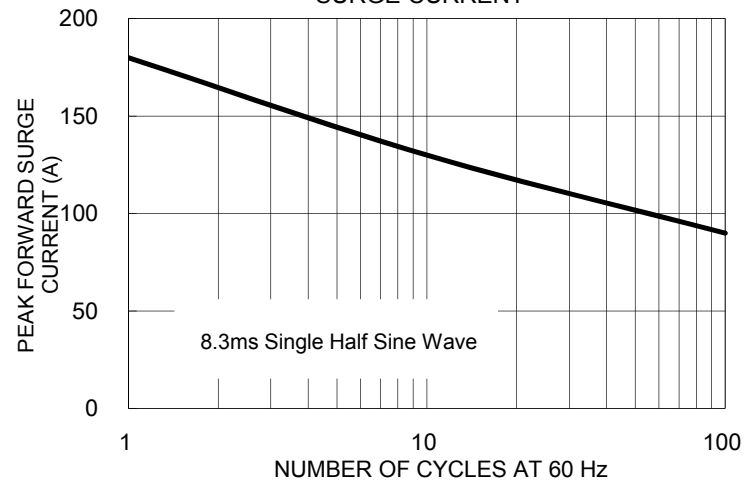

FIG. 3 TYPICAL FORWARD CHARACTERISTICS

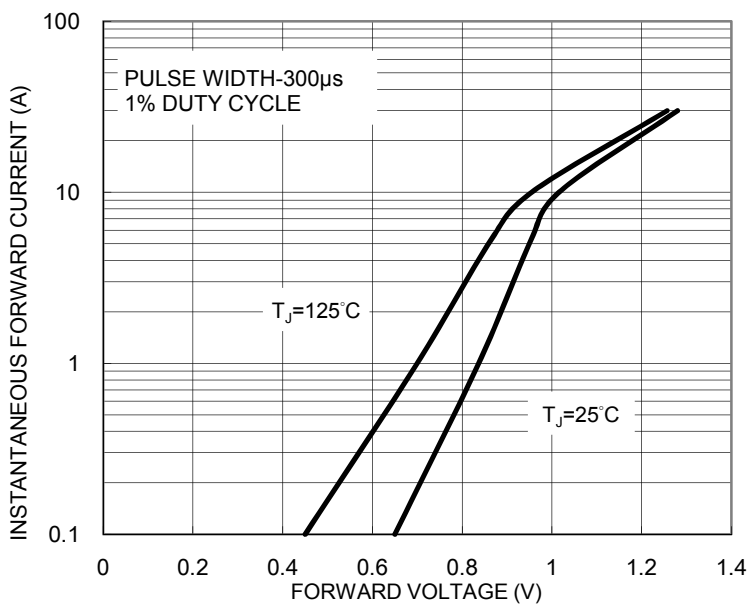

FIG. 4 TYPICAL REVERSE CHARACTERISTICS

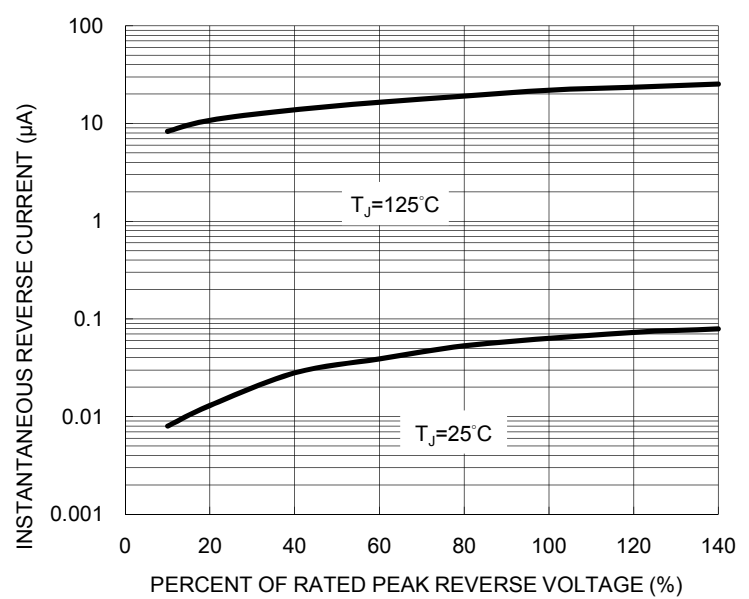
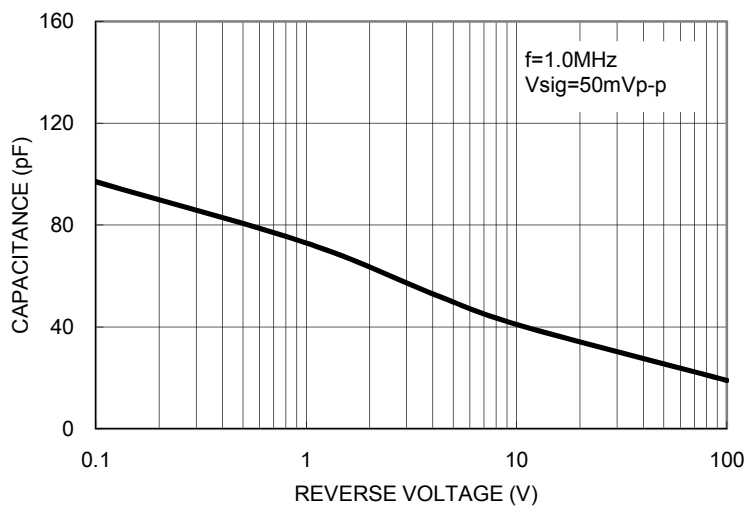
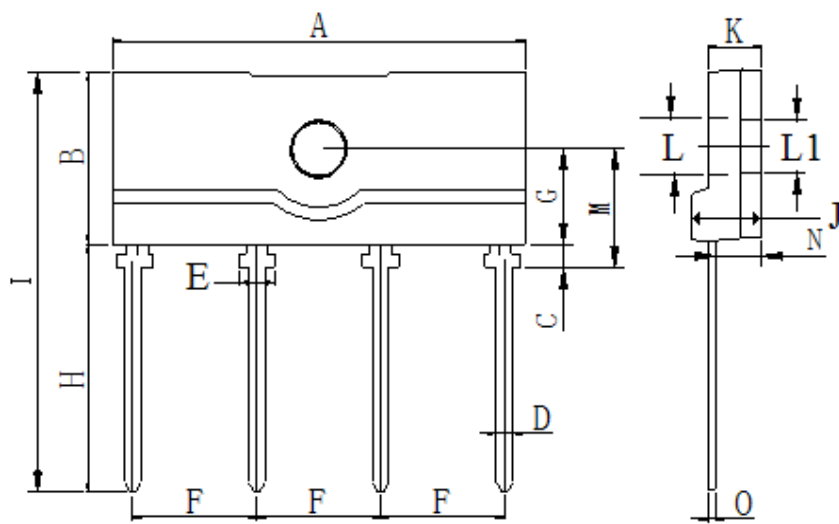

FIG. 5 TYPICAL JUNCTION CAPACITANCE



PACKAGE OUTLINE DIMENSIONS

KBJL



DIM.	Unit (mm)		Unit (inch)	
	Min	Max	Min	Max
A	24.70	25.30	0.972	0.996
B	10.00	10.60	0.394	0.417
C	1.20	1.60	0.047	0.063
D	0.90	1.10	0.035	0.043
E	2.10	2.30	0.083	0.091
F	7.30	7.70	0.287	0.303
G	5.50	5.90	0.217	0.232
H	14.40	15.40	0.567	0.606
I	24.90	25.50	0.980	1.004
J	4.00	4.40	0.157	0.173
K	3.00	3.40	0.118	0.134
L	3.30	3.50	0.130	0.138
L1	3.10	3.30	0.122	0.130
M	6.90	7.30	0.272	0.287
N	2.50	2.90	0.098	0.114
O	0.30	0.70	0.012	0.028

MARKING DIAGRAM

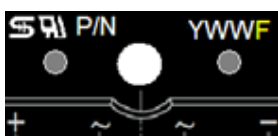

P/N = Specific Device Code
 YWW = Date Code
 F = Factory Code

Notice

Specifications of the products displayed herein are subject to change without notice. TSC or anyone on its behalf, assumes no responsibility or liability for any errors or inaccuracies.

Information contained herein is intended to provide a product description only. No license, express or implied, to any intellectual property rights is granted by this document. Except as provided in TSC's terms and conditions of sale for such products, TSC assumes no liability whatsoever, and disclaims any express or implied warranty, relating to sale and/or use of TSC products including liability or warranties relating to fitness for a particular purpose, merchantability, or infringement of any patent, copyright, or other intellectual property right.

The products shown herein are not designed for use in medical, life-saving, or life-sustaining applications. Customers using or selling these products for use in such applications do so at their own risk and agree to fully indemnify TSC for any damages resulting from such improper use or sale.



Компания «ЭлектроПласт» предлагает заключение долгосрочных отношений при поставках импортных электронных компонентов на взаимовыгодных условиях!

Наши преимущества:

- Оперативные поставки широкого спектра электронных компонентов отечественного и импортного производства напрямую от производителей и с крупнейших мировых складов;
- Поставка более 17-ти миллионов наименований электронных компонентов;
- Поставка сложных, дефицитных, либо снятых с производства позиций;
- Оперативные сроки поставки под заказ (от 5 рабочих дней);
- Экспресс доставка в любую точку России;
- Техническая поддержка проекта, помощь в подборе аналогов, поставка прототипов;
- Система менеджмента качества сертифицирована по Международному стандарту ISO 9001;
- Лицензия ФСБ на осуществление работ с использованием сведений, составляющих государственную тайну;
- Поставка специализированных компонентов (Xilinx, Altera, Analog Devices, Intersil, Interpoint, Microsemi, Aeroflex, Peregrine, Syfer, Eurofarad, Texas Instrument, Miteq, Cobham, E2V, MA-COM, Hittite, Mini-Circuits, General Dynamics и др.);

Помимо этого, одним из направлений компании «ЭлектроПласт» является направление «Источники питания». Мы предлагаем Вам помощь Конструкторского отдела:

- Подбор оптимального решения, техническое обоснование при выборе компонента;
- Подбор аналогов;
- Консультации по применению компонента;
- Поставка образцов и прототипов;
- Техническая поддержка проекта;
- Защита от снятия компонента с производства.



Как с нами связаться

Телефон: 8 (812) 309 58 32 (многоканальный)

Факс: 8 (812) 320-02-42

Электронная почта: org@eplast1.ru

Адрес: 198099, г. Санкт-Петербург, ул. Калинина, дом 2, корпус 4, литера А.