

Features

- High frequency stability
 - ± 10 PPM, ± 15 PPM, ± 20 PPM
 - ± 25 PPM, ± 50 PPM, ± 100 PPM
- Extremely low RMS phase jitter (random)
 - 0.5 ps (typical)
- Wide frequency range
 - 1 to 200 MHz
- Operating voltage
 - 1.8, 2.5, 2.8V or 3.3 V
 - Other voltages up to 3.63 V (contact SiTime)
- Operating temperature range
 - Industrial, -40 to 85 °C
 - Extended Commercial, -20 to 70 °C
 - Commercial, 0 to 70 °C
- Small footprint
 - 2.5 x 2.0 x 0.75 mm
 - 3.2 x 2.5 x 0.75 mm
 - 5.0 x 3.2 x 0.75 mm
 - 7.0 x 5.0 x 0.90 mm
- All packages are Pb-free and ROHs compliant
- High drive option: 30pF load (contact factory)

Benefits

- No crystal or load capacitors required
- Eliminates crystal qualification time
- Ultra-reliable start up and greater immunity from interference
- Replaces expensive single-ended SAW oscillators
- More cost effective than quartz oscillators, quartz crystals and clock ICs.
- Completely quartz-free

Applications

- Communications and Networking Applications
- Consumer Electronics Applications
- Automotive Applications
- Industrial Applications
- Gigabit Ethernet
- 10 Gigabit Ethernet
- Fiber Channel
- Ethernet
- SATA/SAS
- USB 2.0
- PCI-Express

Block Diagram

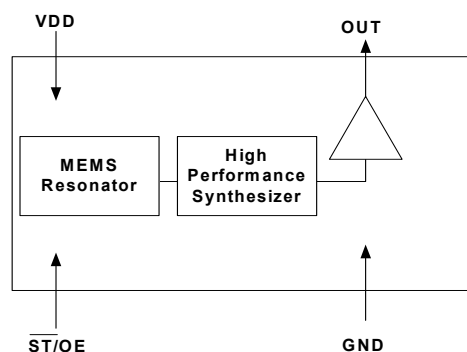

Pinout

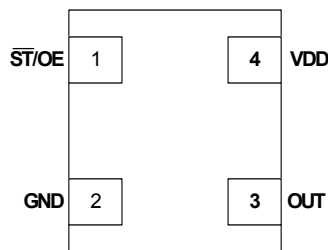

Pin Description

Pin No.	Name	Pin Description
1	ST/OE	Standby/ Output Enable
2	GND	Connect to Ground
3	OUT	1 to 200 MHz Programmed Clock output
4	VDD	Connect to 1.8V / 2.5V / 2.8V / 3.3V

Pin1

Pin #1 Functionality
OE
H or Open; specified frequency output
L: output is high impedance
ST
H or Open; specified frequency output
L: output is low level (weak pull down) oscillation stops

Description

The SiT8102 is the next generation of the SiT8002 programmable oscillator with lower phase noise, lower jitter, and a wider frequency range. SiTime oscillators are the smallest, high-performance programmable oscillator available and are suitable for use in high speed serial communications, consumer, portable, industrial, automotive and computation.

This oscillator is packaged in standard low-cost plastic and chip-scale IC packages.

System reliability is also increased with the SiT8102 by eliminating the quartz crystal and improved immunity to the environmental effects of vibration, shock, strain, and humidity.

To order samples, go to www.sitime.com and click on Request Sample" link.

Absolute Maximum Ratings

Attempted operation outside the absolute maximum ratings of the part may cause permanent damage to the part. Actual performance of the IC is only guaranteed within the operational specifications, not at absolute maximum ratings.

Absolute Maximum Table

Parameter	Min.	Max.	Unit
Storage Temperature	-65	150	°C
VDD	-0.5	+3.66	V
Electrostatic Discharge	–	2000	V
Theta JA (with copper plane on VDD and GND)	–	75	°C/W
Theta JC (with PCB traces of 0.010 inch to all pins)	–	24	°C/W
Soldering Temperature (follow standard Pb free soldering guidelines)	–	260	°C
Number of Program Writes	–	1	NA
Program Retention over -40 to 125 °C, Process, VDD (0 to 3.65V)	–	1,000+	years

Operating Conditions

Parameter	Min.	Typ.	Max.	Unit
Supply Voltages, VDD ^[1]	2.97	3.3	3.63	V
	2.52	2.8	3.08	V
	2.25	2.5	2.75	V
	1.7	1.8	1.9	V
Commercial Operating Temperature	0	–	70	°C
Extended Commercial Operating Temperature	-20	–	70	°C
Industrial Operating Temperature	-40	–	85	°C
Maximum Load Capacitance ^[2]	–	–	15	pF

Environmental Compliance

Parameter	Condition/Test Method
Mechanical Shock	MIL-STD-883F, Method 2002
Mechanical Vibration	MIL-STD-883F, Method 2007
Temperature Cycle	JESD22, Method A104
Solderability	MIL-STD-883F, Method 2003
Moisture Sensitivity Level	MSL1 @ 260°C

Notes:

1. The 3.3V device can operate from 2.25V to 3.63V with higher output drive strength, however, the data sheet specifications cannot be guaranteed. Please contact factory for this option.
2. The output driver strength can be programmed to drive up to 50pF load. Please contact factory for this option.

DC Electrical SpecificationsVDD = 3.3V \pm 10%, -40 to 85°C

Parameter	Condition	Min.	Typ.	Max.	Unit
Output Voltage High	IOH = -9 mA	90	–	–	%Vdd
Output Voltage Low	IOL = 9 mA	–	–	10	%Vdd
Input Voltage High	Pin 1	70	–	–	%Vdd
Input Voltage Low	Pin 1	–	–	30	%Vdd
Operating Current	Output frequency = 30 MHz, 15 pF load	–	–	26	mA
	Output frequency = 125 MHz, 15 pF load	–	–	34	mA
Standby Current	Output is weakly pulled down, ST = GND	–	30	50	μ A
Power Up Time	Time from minimum power supply voltage to the first cycle (Guaranteed no runt pulses)	–	–	10	ms

VDD = 2.5V \pm 10% or VDD = 2.8V \pm 10%, -40 to 85°C

Parameter	Condition	Min.	Typ.	Max.	Unit
Output Voltage High	IOH = -7 mA	90	–	–	%Vdd
Output Voltage Low	IOL = 7mA	-	–	10	%Vdd
Input Voltage High	Pin 1	70	–	–	%Vdd
Input Voltage Low	Pin 1	–	–	30	%Vdd
Operating Current	Output frequency = 30 MHz, 15 pF load	–	–	26	mA
	Output frequency = 125 MHz, 15 pF load	–	–	31	mA
Standby Current	Output is weakly pulled down, ST = GND	–	30	50	μ A
Power Up Time	Time from minimum power supply voltage to the first cycle (Guaranteed no runt pulses)	–	–	10	ms

VDD = 1.8V \pm 5%, -40 to 85°C

Parameter	Condition	Min.	Typ.	Max.	Unit
Output Voltage High	IOH = -5 mA	90	–	–	%Vdd
Output Voltage Low	IOL = 5 mA	-	–	10	%Vdd
Input Voltage High	Pin 1	70	–	–	%Vdd
Input Voltage Low	Pin 1	–	–	30	%Vdd
Operating Current	Output frequency = 30 MHz, 15 pF load	–	–	26	mA
	Output frequency = 125 MHz, 15 pF load	–	–	31	mA
Standby Current	Output is weakly pulled down, ST = GND	–	30	50	μ A
Power Up Time	Time from minimum power supply voltage to the first cycle (Guaranteed no runt pulses)	–	–	10	ms

AC Electrical Specifications

VDD = 3.3V ±10%, -40 to 85°C

Parameter	Condition	Min.	Typ.	Max.	Unit	
Clock Output Frequency		1	-	200	MHz	
Frequency Stability	Inclusive of initial tolerance, operating temp., rated power supply voltage change, load change	0 to 70°C	-10	-	+10	PPM
		-20 to 70°C	-15	-	+15	PPM
		-40 to 85°C	-20	-	+20	PPM
			-25	-	+25	PPM
			-50	-	+50	PPM
		-100	-	+100	PPM	
Aging	First year @ 25 °C	-	-	1	PPM	
Clock Output Duty Cycle	Output frequency= 1 to 125 MHz	45	-	55	%	
	Output frequency= 125 to 200 MHz	40	-	60	%	
Clock Output Rise Time	15 pF Load, 20% to 80% VDD	-	1.0	1.5	ns	
Clock Output Fall Time	15 pF Load, 80% to 20% VDD	-	1.0	1.5	ns	
RMS Period Jitter	Output frequency = 75 MHz	-	2.6	4	ps	
	Output frequency = 125 MHz	-	2.4	3.6	ps	
RMS Phase Jitter (Random)	Output frequency = 75 MHz (900 kHz to 7.5 MHz)	-	0.81	-	ps	
	Output frequency = 106.25 MHz (637kHz to 10 MHz)	-	1.64	-	ps	
	Output frequency = 125 MHz (1.875 to 20 MHz)	-	0.38	-	ps	

VDD = 2.5V ±10% or VDD = 2.8V ±10%, -40 to 85°C

Parameter	Condition	Min.	Typ.	Max.	Unit	
Clock Output Frequency		1	-	200	MHz	
Frequency Stability	Inclusive of initial tolerance, operating temp., rated power supply voltage change, load change	0 to 70°C	-10	-	+10	PPM
		-20 to 70°C	-15	-	+15	PPM
		-40 to 85°C	-20	-	+20	PPM
			-25	-	+25	PPM
			-50	-	+50	PPM
		-100	-	+100	PPM	
Aging	First year @ 25 °C	-	-	1	PPM	
Clock Output Duty Cycle	Output frequency= 1MHz to 125MHz	45	-	55	%	
	Output frequency= 125MHz to 200MHz	40	-	60	%	
Clock Output Rise Time	15 pF Load, 20% to 80% VDD	-	1.0	1.5	ns	
Clock Output Fall Time	15 pF Load, 80% to 20% VDD	-	1.0	1.5	ns	
RMS Period Jitter	Output frequency = 75 MHz	-	3	6	ps	
	Output frequency = 125 MHz	-	2.8	5	ps	
RMS Phase Jitter (Random)	Output frequency = 75 MHz (900 kHz to 7.5 MHz)	-	0.87	-	ps	
	Output frequency = 106.25 MHz (637kHz to 10 MHz)	-	1.7	-	ps	
	Output frequency = 125 MHz (1.875 to 20 MHz)	-	0.41	-	ps	

VDD = 1.8V ±5%, -40 to 85°C

Parameter	Condition	Min.	Typ.	Max.	Unit	
Clock Output Frequency		1	–	200	MHz	
Frequency Stability	Inclusive of initial tolerance, operating temp., rated power supply voltage change, load change	0 to 70°C	-15	–	+15	PPM
		-20 to 70°C -40 to 85°C	-20	–	+20	PPM
			-25		+25	PPM
			-50		+50	PPM
			-100		+100	PPM
Aging	First year @ 25 °C	–	–	1	PPM	
Clock Output Duty Cycle	Output frequency= 1 MHz to 75 MHz	45	–	55	%	
	Output frequency= 75 MHz to 200 MHz	40	–	60	%	
Clock Output Rise Time	15 pF Load, 20% to 80% VDD	–	1.0	1.5	ns	
Clock Output Fall Time	15 pF Load, 80% to 20% VDD	–	1.0	1.5	ns	
RMS Period Jitter	Output frequency = 75 MHz	–	7.3	14	ps	
	Output frequency = 125 MHz	–	7.1	14	ps	
RMS Phase Jitter (Random)	Output frequency = 75 MHz (900 kHz to 7.5 MHz)	–	0.85	–	ps	
	Output frequency = 106.25 MHz (637kHz to 10 MHz)	–	1.72	–	ps	
	Output frequency = 125 MHz (1.875 to 20 MHz)	–	1.06	–	ps	

Ordering Information

SiT8102AC-13-25E - 105.12345T

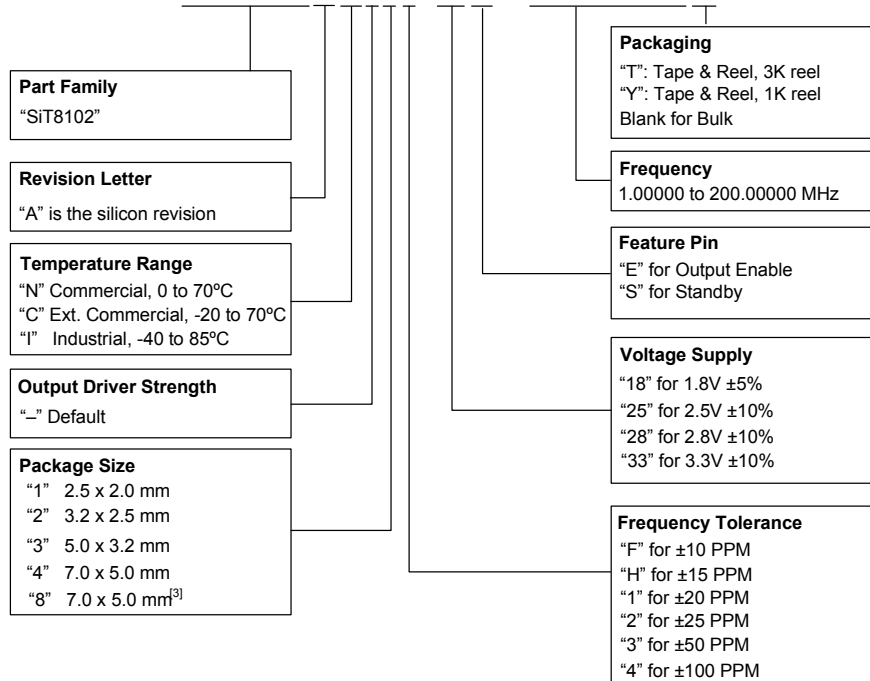
**Notes:**

- 3. Without Center Pad.

Frequency Stability vs. Temperature Range Options

Frequency Stability (PPM)	Temperature Range	Supply Voltage		
		1.8 V	2.5 V	3.3 V
±10	N (0 to +70°C)	-	✓	✓
	C (-20 to +70°C)	-	-	-
	I (-40 to +85°C)	-	-	-
±15	N (0 to +70°C)	✓	✓	✓
	C (-20 to +70°C)	-	✓	✓
	I (-40 to +85°C)	-	✓	✓
±20	N (0 to +70°C)	✓	✓	✓
	C (-20 to +70°C)	✓	✓	✓
	I (-40 to +85°C)	✓	✓	✓
±25	N (0 to +70°C)	✓	✓	✓
	C (-20 to +70°C)	✓	✓	✓
	I (-40 to +85°C)	✓	✓	✓
±50	N (0 to +70°C)	✓	✓	✓
	C (-20 to +70°C)	✓	✓	✓
	I (-40 to +85°C)	✓	✓	✓

Package Information [4,5]

Dimension (mm)

2.5 x 2.0 x 0.75mm

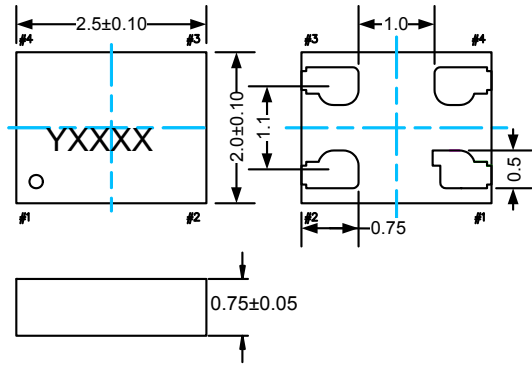

Land Pattern (recommended) (mm)^[6]

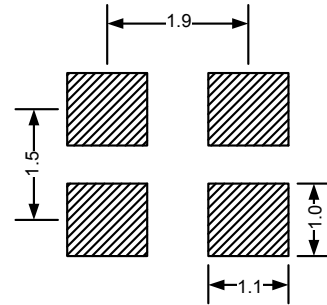

3.2 x 2.5 x 0.75 mm

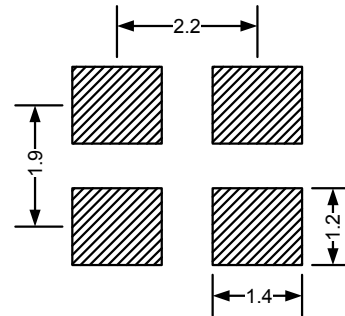
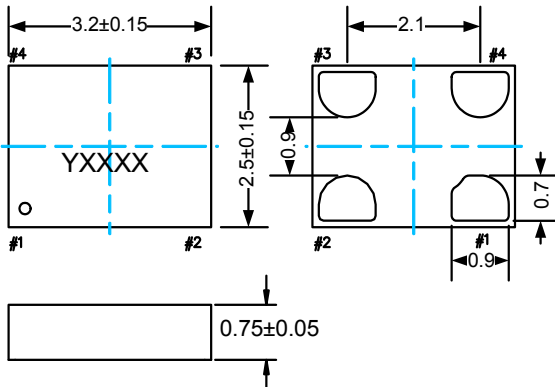

5.0 x 3.2 x 0.75 mm

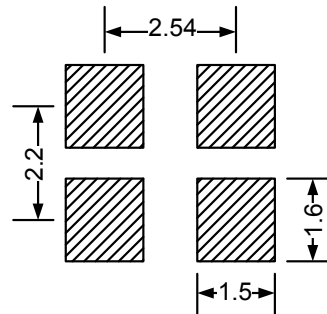
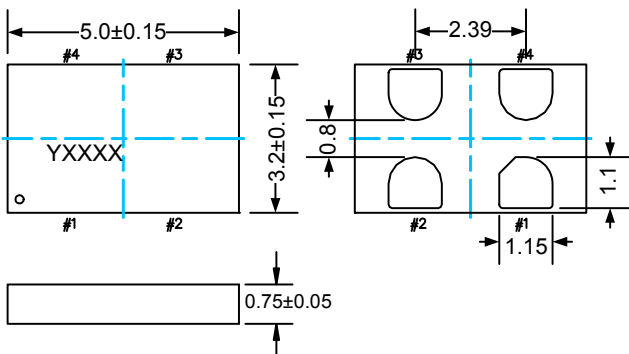

Package Information (continued)^[4,5]

Dimension (mm)

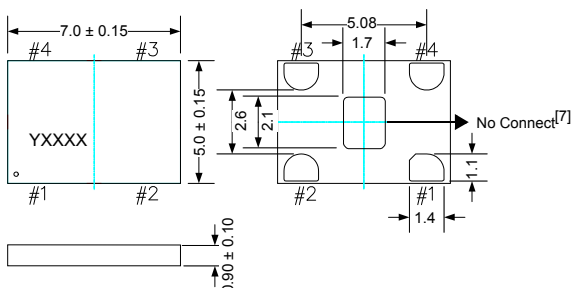

Land Pattern (recommended) (mm)^[6]

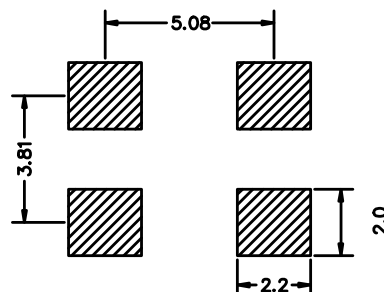

Notes:

4. Y top marking denotes manufacturing origin. The value of “Y” will depend on the assembly location of the device.
5. XXXX top marking denotes manufacturing lot number.
6. A capacitor of value 0.1μF between VDD and GND is recommended.
7. The 7050 package with part number designation “-8” has NO center pad.

© SiTime Corporation 2010. The information contained herein is subject to change at any time without notice. SiTime assumes no responsibility or liability for any loss, damage or defect of a Product which is caused in whole or in part by (i) use of any circuitry other than circuitry embodied in a SiTime product, (ii) misuse or abuse including static discharge, neglect or accident, (iii) unauthorized modification or repairs which have been soldered or altered during assembly and are not capable of being tested by SiTime under its normal test conditions, or (iv) improper installation, storage, handling, warehousing or transportation, or (v) being subjected to unusual physical, thermal, or electrical stress.

Disclaimer: SiTime makes no warranty of any kind, express or implied, with regard to this material, and specifically disclaims any and all express or implied warranties, either in fact or by operation of law, statutory or otherwise, including the implied warranties of merchantability and fitness for use or a particular purpose, and any implied warranty arising from course of dealing or usage of trade, as well as any common-law duties relating to accuracy or lack of negligence, with respect to this material, any sitime product and any product documentation. Products sold by siTime are not suitable or intended to be used in a life support application or component, to operate nuclear facilities, or in other mission critical applications where human life may be involved or at stake. All sales are made conditioned upon compliance with the critical uses policy set forth below.

CRITICAL USE EXCLUSION POLICY

BUYER AGREES NOT TO USE SITIME'S PRODUCTS FOR ANY APPLICATION OR IN ANY COMPONENTS USED IN LIFE SUPPORT DEVICES OR TO OPERATE NUCLEAR FACILITIES OR FOR USE IN OTHER MISSION-CRITICAL APPLICATIONS OR COMPONENTS WHERE HUMAN LIFE OR PROPERTY MAY BE AT STAKE.

SiTime owns all rights, title and interest to the intellectual property related to SiTime's products, including any software, firmware, copyright, patent, or trademark. The sale of SiTime products does not convey or imply any license under patent or other rights. SiTime retains the copyright and trademark rights in all documents, catalogs and plans supplied pursuant to or ancillary to the sale of products or services by SiTime. Unless otherwise agreed to in writing by SiTime, any reproduction, modification, translation, compilation, or representation of this material shall be strictly prohibited.



Компания «ЭлектроПласт» предлагает заключение долгосрочных отношений при поставках импортных электронных компонентов на взаимовыгодных условиях!

Наши преимущества:

- Оперативные поставки широкого спектра электронных компонентов отечественного и импортного производства напрямую от производителей и с крупнейших мировых складов;
- Поставка более 17-ти миллионов наименований электронных компонентов;
- Поставка сложных, дефицитных, либо снятых с производства позиций;
- Оперативные сроки поставки под заказ (от 5 рабочих дней);
- Экспресс доставка в любую точку России;
- Техническая поддержка проекта, помощь в подборе аналогов, поставка прототипов;
- Система менеджмента качества сертифицирована по Международному стандарту ISO 9001;
- Лицензия ФСБ на осуществление работ с использованием сведений, составляющих государственную тайну;
- Поставка специализированных компонентов (Xilinx, Altera, Analog Devices, Intersil, Interpoint, Microsemi, Aeroflex, Peregrine, Syfer, Eurofarad, Texas Instrument, Miteq, Cobham, E2V, MA-COM, Hittite, Mini-Circuits, General Dynamics и др.);

Помимо этого, одним из направлений компании «ЭлектроПласт» является направление «Источники питания». Мы предлагаем Вам помощь Конструкторского отдела:

- Подбор оптимального решения, техническое обоснование при выборе компонента;
- Подбор аналогов;
- Консультации по применению компонента;
- Поставка образцов и прототипов;
- Техническая поддержка проекта;
- Защита от снятия компонента с производства.



Как с нами связаться

Телефон: 8 (812) 309 58 32 (многоканальный)

Факс: 8 (812) 320-02-42

Электронная почта: org@eplast1.ru

Адрес: 198099, г. Санкт-Петербург, ул. Калинина, дом 2, корпус 4, литера А.