



GENERAL DESCRIPTION

The XRP6141 is a synchronous step-down controller for point-of load supplies up to 35A. A wide 4.5V to 22V input voltage range allows for single supply operation from industry standard 5V, 12V and 19.6V rails.

With a proprietary emulated current mode Constant On-Time (COT) control scheme, the XRP6141 provides extremely fast line and load transient response using ceramic output capacitors. It requires no loop compensation hence simplifying circuit implementation and reducing overall component count. The control loop also provides exceptional line regulation and maintains constant operating frequency. A selectable power saving mode, allows the user to operate in discontinuous mode (DCM) at light current loads thereby significantly increasing the converter efficiency.

A host of protection features, including over-current, over-temperature, short-circuit and UVLO, help achieve safe operation under abnormal operating conditions.

The XRP6141 is available in RoHS compliant, green/halogen free space-saving 16-pin 3x3 QFN package.

APPLICATIONS

- Networking and Communications
- Fast Transient Point-of-Loads
- Industrial and Medical Equipment
- Embedded High Power FPGA

FEATURES

- **35A Capable Step Down Controller**
 - Wide Input Voltage Range
 - 5V to 22V Single Supply
 - 4.5V to 5.5V Low Vin
 - Integrated high Current 2A/3A Drivers
 - 0.6V to 18V Adjustable Output Voltage
- **Proprietary Constant On-Time Control**
 - No Loop Compensation Required
 - Ceramic Output Cap. Stable operation
 - Programmable 200ns-2µs
 - Constant 200kHz-800kHz Frequency
 - Selectable CCM or CCM/DCM Operation
- **Programmable hiccup current limit with thermal compensation**
- **Precision Enable and Power-Good Flag**
- **Programmable Soft-start**
- **Integrated Bootstrap diode**
- **16-pin QFN Package**

TYPICAL APPLICATION DIAGRAM

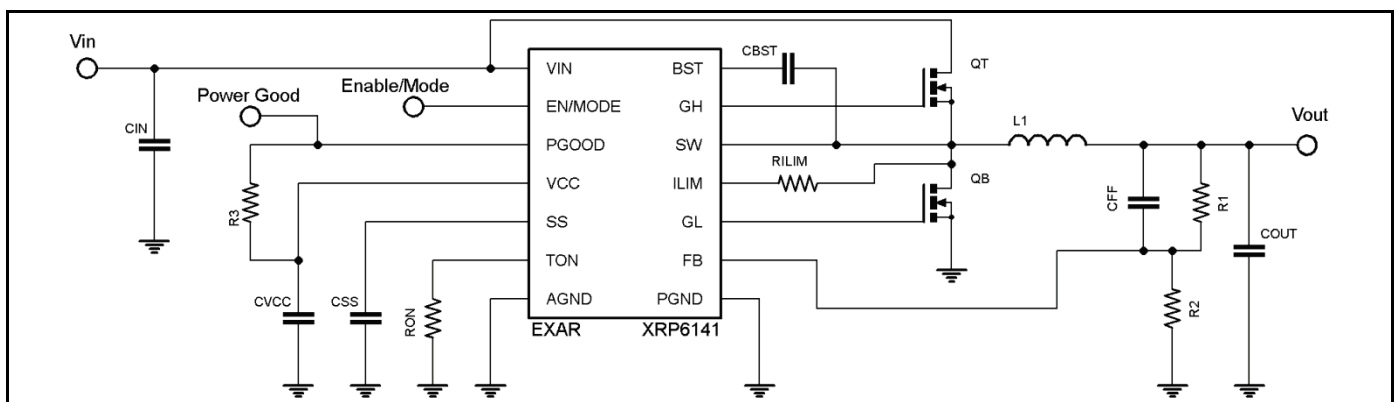

Fig. 1: XRP6141 Application Diagram

35A Synchronous Step Down COT Controller

ABSOLUTE MAXIMUM RATINGS

These are stress ratings only and functional operation of the device at these ratings or any other above those indicated in the operation sections of the specifications below is not implied. Exposure to absolute maximum rating conditions for extended periods of time may affect reliability.

V _{IN}	-0.3V to 28V
V _{CC}	-0.3V to 6.0V
BST	-0.3V to 34V ²
BST-SW	-0.3V to 6V
SW, ILIM	-5V to 28V ^{1,2}
GH.....	-0.3V to BST+0.3V
GH-SW.....	-0.3V to 6V
ALL other pins.....	-0.3V to V _{CC} +0.3V
Storage Temperature.....	-65°C to 150°C
Junction Temperature	150°C
Power Dissipation	Internally Limited
Lead Temperature (Soldering, 10 sec)	300°C
ESD Rating (HBM - Human Body Model).....	2kV

OPERATING RATINGS

V _{IN}	-0.3V to 22V
V _{CC}	-0.3V to 5.5V
SW, ILIM	-1V to 26V ¹
PGOOD, VCC, TON, SS, EN, GL, FB	-0.3V to 5.5V
Switching Frequency	200kHz-800kHz ³
Junction Temperature Range	-40°C to 125°C

Note 1: SW pin's minimum DC range is -1V, transient is -5V for less than 50ns

Note 2: No external voltage applied

Note 3: Recommended

ELECTRICAL SPECIFICATIONS

Specifications are for Operating Junction Temperature of T_J = 25°C only; limits applying over the full Operating Junction Temperature range are denoted by a "•". Minimum and Maximum limits are guaranteed through test, design, or statistical correlation. Typical values represent the most likely parametric norm at T_J = 25°C, and are provided for reference purposes only. Unless otherwise indicated, V_{IN} = 12V, BST=V_{CC}, SW=GND=PGND=0V, CGH=CGL=3.3nF.

Parameter	Min.	Typ.	Max.	Units	Conditions
Power Supply Characteristics					
V _{IN} , Input Voltage Range	5	12	22	V	• VCC regulating
	4.5	5.0	5.5		• VCC tied to VIN
I _{VIN} , VIN supply current		0.7	2	mA	• Not switching, V _{IN} =12V, VFB=0.7V
I _{VCC} , VCC Quiescent current		0.7	2	mA	• Not switching, V _{CC} =V _{IN} =5V, VFB=0.7V
I _{VIN} , VIN supply current		11		mA	f=300kHz, RON=108.8k, VFB=0.58V
I _{OFF} , Shutdown current		0.1		µA	Enable=0V, V _{IN} =12V
Enable and Under-Voltage Lock-Out UVLO					
V _{IH_EN} , EN Pin Rising Threshold	1.8	1.9	2.0	V	•
V _{EN_HYS} , EN Pin Hysteresis		50		mV	
V _{IH_EN} , EN Pin Rising Threshold for DCM/CCM operation	2.9	3.0	3.1	V	•
V _{EN_HYS} , EN Pin Hysteresis		100		mV	
VCC UVLO start threshold, rising edge	4.00	4.25	4.50	V	•
VCC UVLO Hysteresis		200		mV	
Reference voltage					
V _{REF} , Reference voltage	0.597	0.600	0.603	V	V _{IN} =5V-22V→ VCC regulating
	0.596		0.604	V	V _{IN} =4.5V-5.5V→ tie VCC to VIN
	0.594	0.600	0.606	V	• V _{IN} =5V-22V→ VCC regulating, V _{IN} =4.5V-5.5V→ tie VCC to VIN
DC Line regulation		±0.1		%	CCM operation, closed loop, applies to any COUT
DC Load regulation		±0.25		%	CCM operation, closed loop, applies to any



A New Direction in Mixed-Signal

XRP6141

35A Synchronous Step Down COT Controller

Parameter	Min.	Typ.	Max.	Units	Conditions
COUT					
Programmable Constant On-Time					
On-Time 1	1855	2182	2509	ns	• RON = 141.2kΩ, VIN=22V
f corresponding to On-Time 1	217	250	294	kHz	VIN=22V, VOUT=12V
Minimum Programmable On-Time		109		ns	RON = 7.059kΩ, VIN=22V
On-Time 2	170	200	230	ns	• RON = 7.059kΩ, VIN=12V
f corresponding to On-Time 2	1618	1375	1196	kHz	VOUT=3.3V
f corresponding to On-Time 2	490	417	362	kHz	VOUT=1.0V
On-Time 3	391	460	529	ns	• RON = 16.235kΩ, VIN=12V
Minimum Off-Time		250	350	ns	•
Diode Emulation Mode					
Zero crossing threshold	-4	-1		mV	DC value measured during test
SoftStart					
SS Charge current	-14	-10	-6	μA	•
SS Discharge current	1			mA	• Fault present
VCC Linear Regulator (VCC should be tied to VIN, for 4.5V ≤ VIN ≤ 5.5V)					
VCC Output Voltage	4.8	5.0	5.2	V	• VIN=6V to 22V, Iload=0 to 30mA
	4.51	4.7			• VIN=5V, Iload=0 to 20mA
Dropout Voltage	200	300	490	mV	• IVCC=30mA
Power Good Output					
Power Good Threshold	-10	-7.5	-5	%	
Power Good Hysteresis		2	4	%	
Power Good Sink Current	1			mA	
Protection: OCP, OTP, Short-circuit					
Hiccup timeout		110		ms	
ILIM pin source current	45	50	55	μA	
ILIM current temperature coeff.		0.4		%/°C	
OCP comparator offset	-8	0	+8	mV	•
Current limit blanking		100		ns	GL rising > 1V
Thermal shutdown threshold ¹		150		°C	Rising temperature
Thermal Hysteresis ¹		15		°C	
VSCTH Feedback pin short-circuit threshold	50	60	70	%	• Percent of VREF, short circuit is active After PGOOD is up
Output Gate drivers					
GH Pull-Down Resistance		1.35	2.0	Ω	IGH=200mA
GH Pull-up Resistance		1.8	2.8	Ω	IGH=200mA
GL Pull-Down Resistance		1.35	1.9	Ω	IGL=200mA
GL Pull-up Resistance		1.7	2.7	Ω	IGL=200mA
GH and GL pull-down Resistance		50	---	kΩ	
GH and GL rise time		35	50	ns	10% to 90%
GH and GL fall time		30	40	ns	90% to 10%
GL to GH non-overlap time	20	30	60	ns	Measured GL falling edge = 1V to GH rising edge = 1V, BST=VCC, SW=0V
GH to GL non-overlap time	15	20	40	ns	Measured GH falling edge = 1V to GL rising edge = 1V

Note 1: Guaranteed by design

BLOCK DIAGRAM

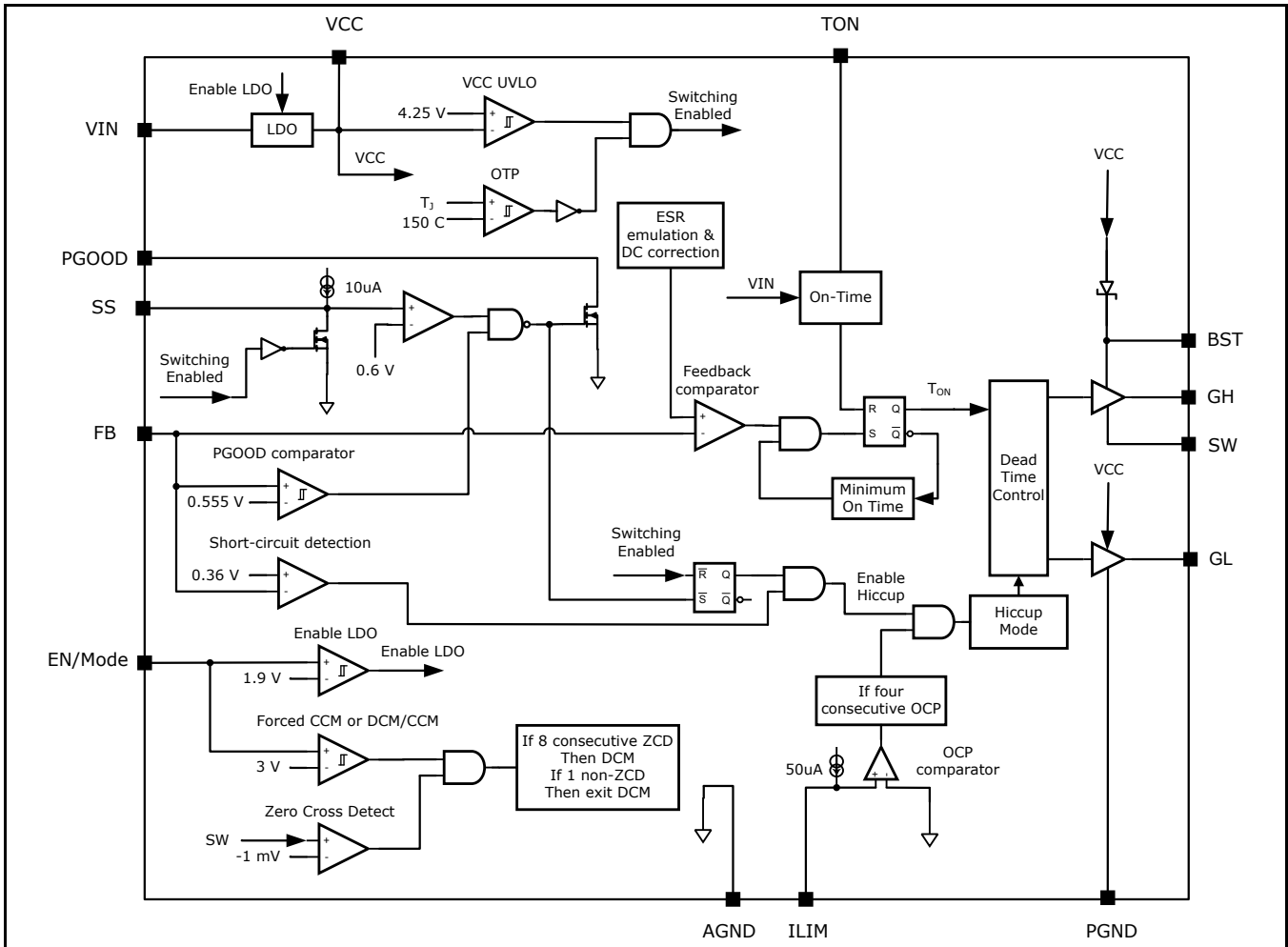

Fig. 2: XRP6141 Block Diagram

PIN ASSIGNMENT

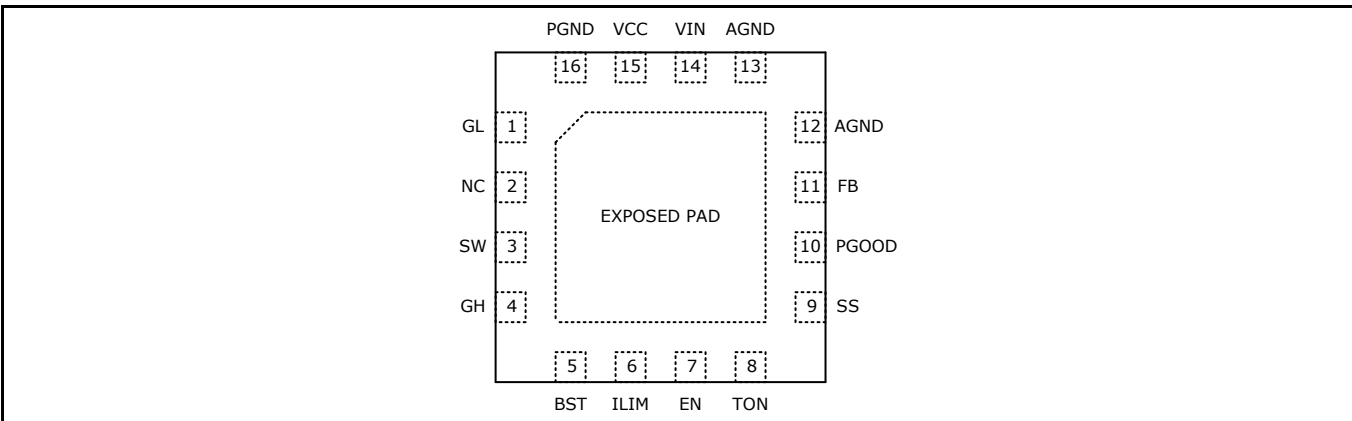

Fig. 3: XRP6141 Pin Assignment

35A Synchronous Step Down COT Controller

PIN DESCRIPTION

Name	Pin Number	Description
GL	1	Driver output for Low-side N-channel synchronous MOSFET.
NC	2	Internally not connected. Leave this pin floating.
SW	3	Lower supply rail for high-side gate driver GH. Connect this pin to the junction between the two external N-channel MOSFETs.
GH	4	Driver output for high-side N-channel switching MOSFET.
BST	5	High-side driver supply pin. Connect a 0.1uF bootstrap capacitor between BST and SW.
ILIM	6	Over-current protection programming. Connect with a resistor to the Drain of the low-side MOSFET.
EN/MODE	7	Precision enable pin. Pulling this pin above 1.9V will turn the IC on and it will operate in Forced CCM. If the voltage is raised above 3.0V then the IC will operate in DCM or CCM depending on load.
TON	8	Constant on-time programming pin. Connect with a resistor to AGND.
SS	9	Soft-Start pin. Connect an external capacitor between SS and AGND to program the soft-start rate based on the 10uA internal source current.
PGOOD	10	Power-good output. This open-drain output is pulled low when V _{OUT} is outside the regulation.
FB	11	Feedback input to feedback comparator. Connect with a set of resistors to V _{OUT} and GND in order to program V _{OUT} .
AGND	12, 13	Analog ground. Control circuitry of the IC is referenced to this pin.
VIN	14	IC supply input. Provides power to internal LDO.
VCC	15	The output of LDO. For operation using a 5V rail, VCC should be shorted to VIN.
PGND	16	Low side driver ground
Exposed Pad		Thermal pad for heat dissipation. Connect to AGND with a short trace.

ORDERING INFORMATION

Part Number	Temperature Range	Marking	Package	Packing Quantity	Note 1
XRP6141EL-F	-40°C ≤ T _J ≤ +125°C	6141 YWW XXXX	3x3mm QFN16	Tray	Lead Free and/or Halogen Free
XRP6141ELMTR-F	-40°C ≤ T _J ≤ +125°C			250/Tape & Reel	
XRP6141ELTR-F	-40°C ≤ T _J ≤ +125°C			3k/Tape & Reel	
XRP6141EVB	XRP6141 Evaluation Board				

“Y” = Year - “WW” = Work Week - “X” = Lot Number; when applicable.

TYPICAL PERFORMANCE CHARACTERISTICS

All data taken at $V_{IN} = 12V$, $V_{OUT}=1.2V$, $f=300kHz$, $T_A = 25^{\circ}C$, unless otherwise specified - Schematic and BOM from Application Information section of this datasheet.

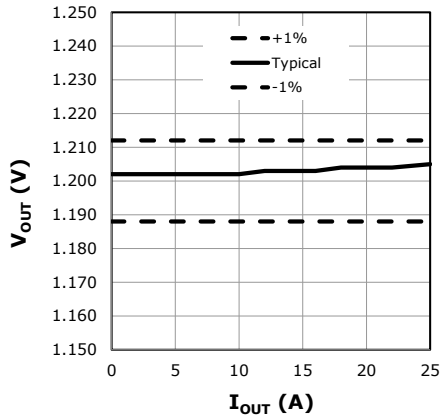

Fig. 4: Load regulation, $V_{IN}=12V$

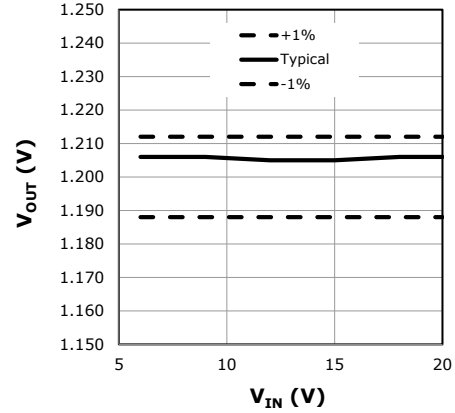

Fig. 5: Line regulation, $I_{OUT}=25A$

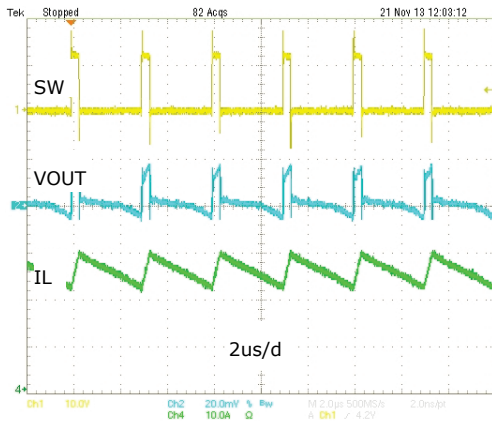

Fig. 6: V_{OUT} ripple is 22mV at 25A, 12 V_{IN} , 1.2 V_{OUT}

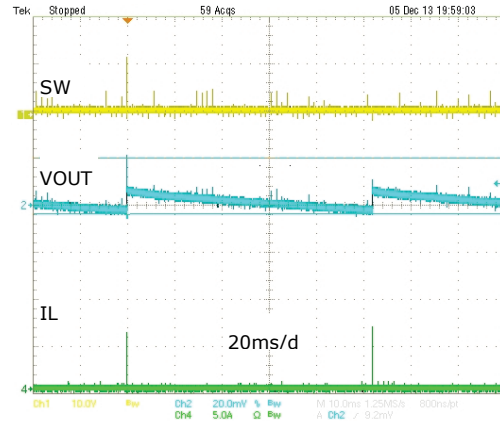

Fig. 7: V_{OUT} ripple is 22mV at 0A, DCM, 12 V_{IN} , 1.2 V_{OUT}

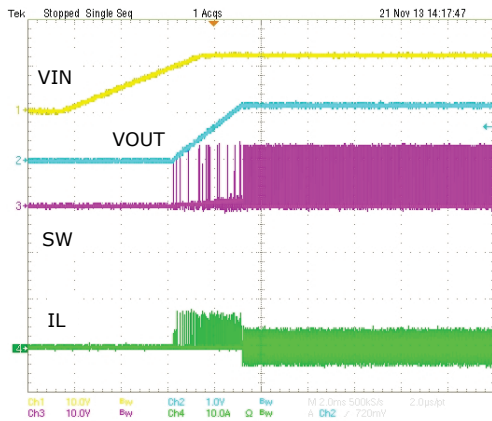

Fig. 8: Powerup, Forced CCM, $I_{OUT}=0A$

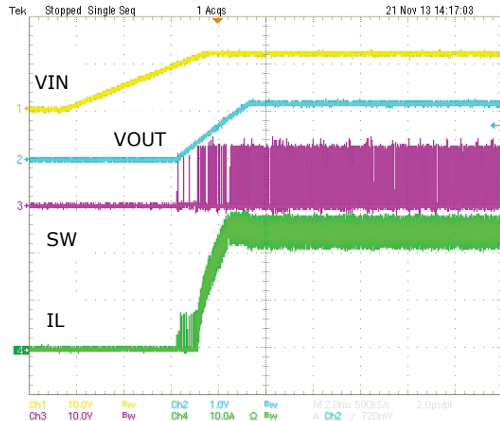

Fig. 9: Powerup, Forced CCM, $I_{OUT}=25A$

35A Synchronous Step Down COT Controller

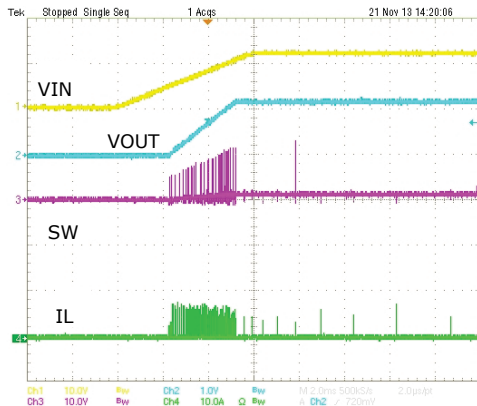

Fig. 10: Powerup, DCM/CCM, $I_{OUT}=0A$

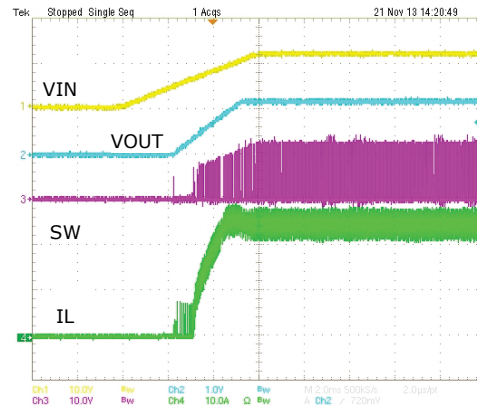

Fig. 11: Powerup, DCM/CCM, $I_{OUT}=25A$

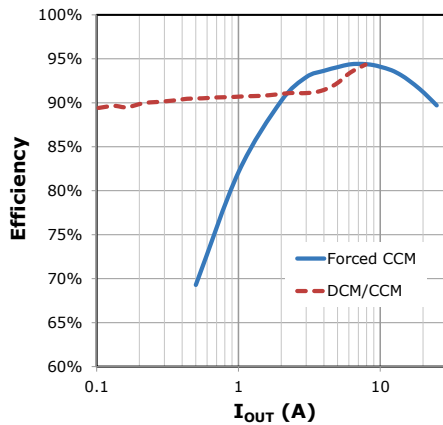

Fig. 12: Efficiency, $5V_{IN}$, $1.8V_{OUT}$, $0.47\mu H$, $300kHz$

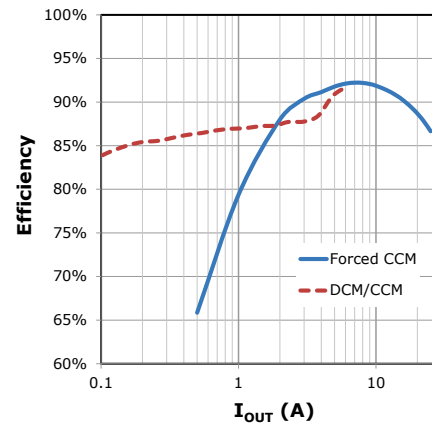

Fig. 13: Efficiency, $5V_{IN}$, $1.2V_{OUT}$, $0.47\mu H$, $300kHz$

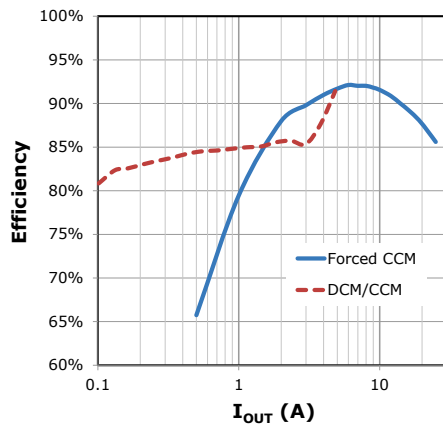

Fig. 14: Efficiency, $5V_{IN}$, $1.0V_{OUT}$, $0.47\mu H$, $300kHz$

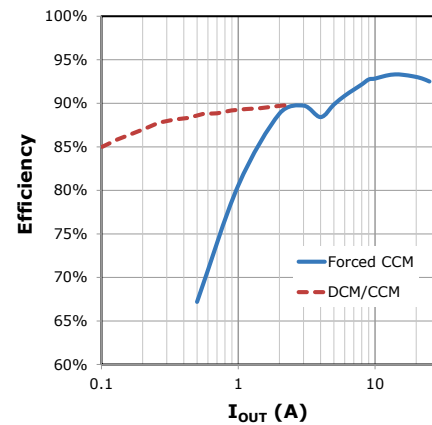

Fig. 15: Efficiency, $12V_{IN}$, $3.3V_{OUT}$, $1\mu H$, $300kHz$



A New Direction in Mixed-Signal

XRP6141

35A Synchronous Step Down COT Controller

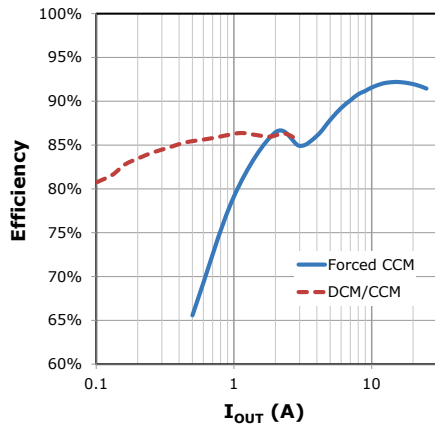

Fig. 16: Efficiency, 12V_{IN}, 2.5V_{OUT}, 1uH, 300kHz

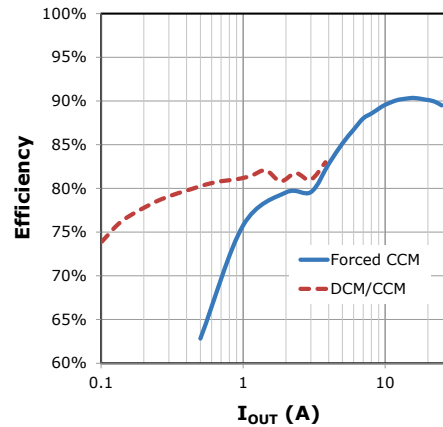

Fig. 17: Efficiency, 12V_{IN}, 1.8V_{OUT}, 1uH, 300kHz

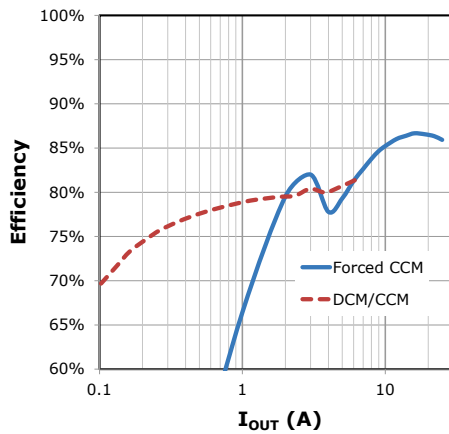

Fig. 18: Efficiency, 12V_{IN}, 1.2V_{OUT}, 0.47uH, 300kHz

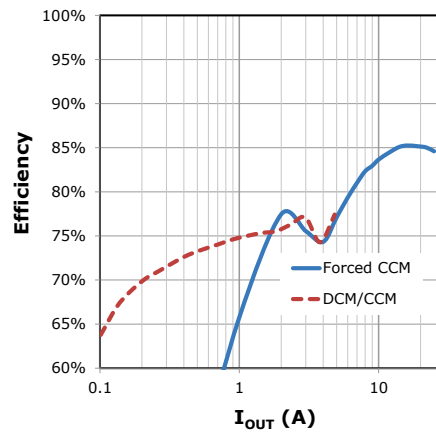

Fig. 19: Efficiency, 12V_{IN}, 1.0V_{OUT}, 0.47uH, 300kHz

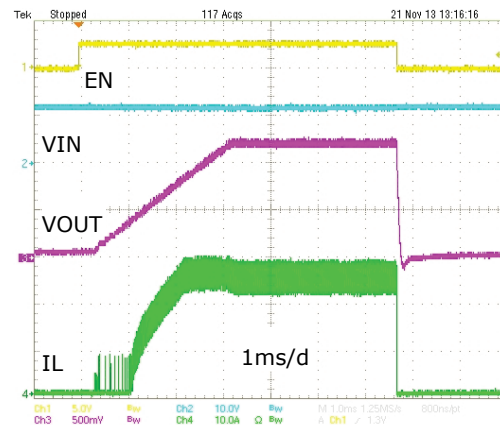

Fig. 20: Enable turn on/turn off, 12V_{IN}, 1.2V_{OUT}, 25A

35A Synchronous Step Down COT Controller

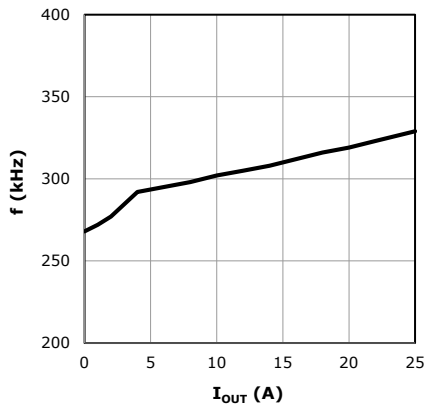

Fig. 22: frequency versus I_{OUT}, Forced CCM

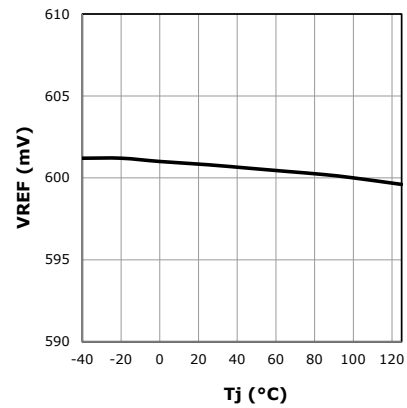

Fig. 23: VREF versus temperature

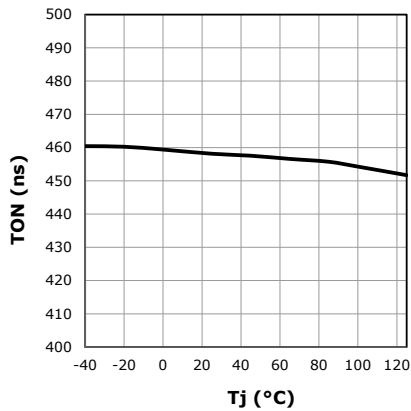

Fig. 24: On-Time versus temperature

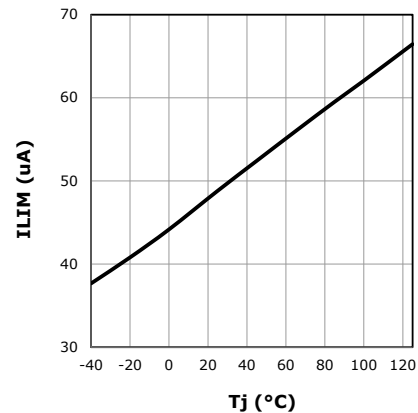

Fig. 25: ILIM versus temperature

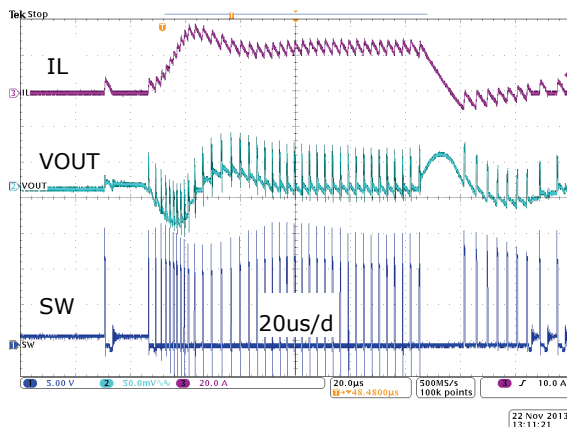

Fig. 26: Load step, DCM/CCM, 0A-25A-0A

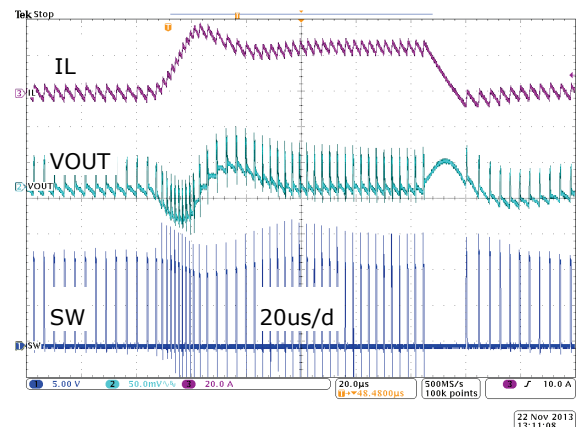

Fig. 27: Load step, Forced CCM, 0A-25A-0A

DETAILED OPERATION

XRP6141 is a synchronous step-down proprietary emulated current-mode Constant On-Time (COT) controller. The on-time, which is programmed via RON, is inversely proportional to VIN and maintains a nearly constant frequency. The emulated current-mode control allows the use of ceramic output capacitors.

Each switching cycle begins with GH signal turning the high-side (switching) FET for a preprogrammed time. At the end of the on-time the high-side FET is turned off and the low-side (synchronous) FET is turned on for a preset minimum time (250ns nominal). This parameter is termed Minimum Off-Time. After the minimum off-time the voltage at the feedback pin FB is compared to an internal voltage ramp at the feedback comparator. When VFB drops below the ramp voltage, the high-side FET is turned on and the cycle repeats. This voltage ramp constitutes an emulated current ramp and makes possible the use of ceramic capacitors, in addition to other capacitor types, for output filtering.

ENABLE/MODE

EN/MODE pin accepts a tri-level signal that is used to control turn on/off. It also selects between two modes of operation: 'Forced CCM' and 'DCM/CCM'. If EN is pulled below 1.9V the IC shuts down. A voltage between 1.9V and 3V selects the Forced CCM mode, which will run the converter in continuous conduction at all times. A voltage higher than 3V selects the DCM/CCM mode, which will run the converter in discontinuous conduction at light loads. DCM/CCM, which is based on diode emulation, is described below.

Diode Emulation Mode (DCM/CCM)

Diode Emulation Mode is designed to increase the converter efficiency at light loads. Light-load efficiency is increased by preventing negative inductor current. This is achieved by monitoring the inductor current valley (bottom) via SW and turning off the synchronous FET as inductor current I_L approaches zero. I_L is monitored indirectly by monitoring V_{SW} during the synchronous FET conduction (i.e., $V_{SW} = I_L \times R_{ds}$). If V_{SW} does not drop to $-1mV$ the converter operates in continuous conduction as shown in figure 28. If V_{SW} equals $-1mV$ then a zero-crossing is detected (figure 29). Eight consecutive zero-crossings activate the diode emulation mode. Then, on every subsequent switching cycle, GL is turned off when V_{SW} reaches $-1mV$ (figure 30). If I_{OUT} decreases further, discontinuous conduction ensues (figure 30). The constant on-time delivers a fixed energy at the start of each switching cycle. The synchronous FET is turned off when V_{SW} drops to $-1mV$. Remaining inductor energy is discharged through the FET's body diode. Now, because I_{OUT} is low, it takes longer for V_{OUT} to drop below regulation and trigger a new switching cycle. Hence switching frequency f decreases. This increase the efficiency at light loads.

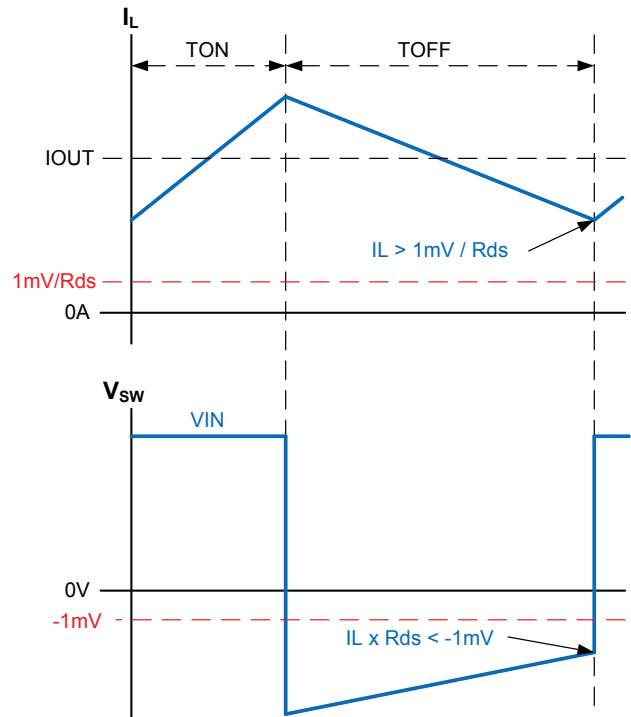

Figure 28. Continuous conduction during diode emulation

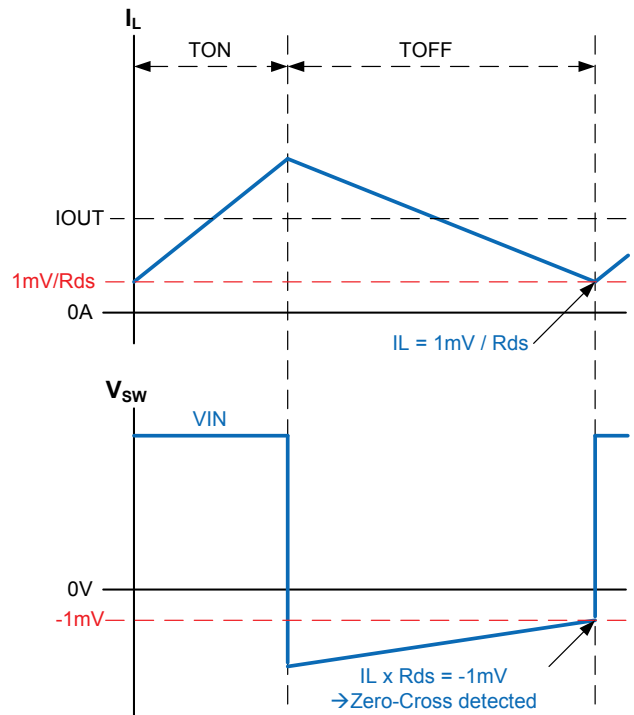

Figure 29. Zero-Crossing detection

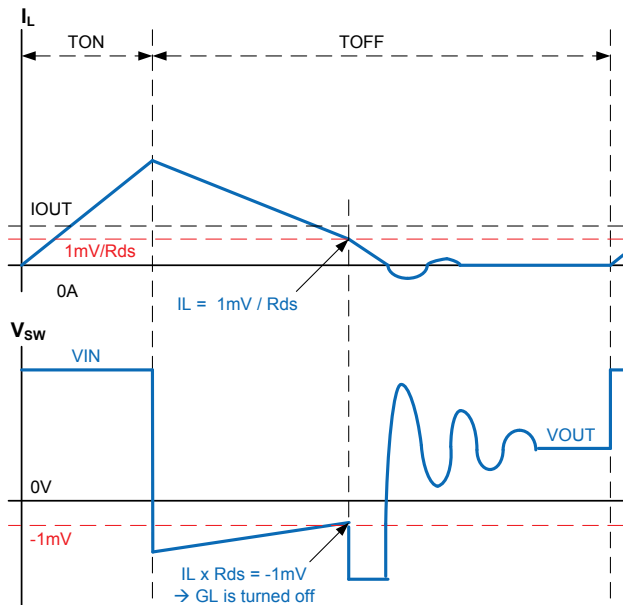

Figure 30. Discontinuous conduction during diode emulation

PROGRAMMING THE ON-TIME

The on-time TON is programmed via resistor RON according to following equation:

$$TON = \frac{(3.4E - 10) \times RON}{VIN}$$

The required TON for a given application is calculated from:

$$TON = \frac{VOUT}{VIN \times f}$$

Note that switching frequency f will increase somewhat, as a function of increasing load current and increasing losses (see figure 22).

OVER-CURRENT PROTECTION (OCP)

If load current exceeds the programmed overcurrent IOCP for four consecutive switching cycles, then IC enters hiccup mode of operation. In hiccup the MOSFET gates are turned off for 110ms (hiccup timeout). Following the hiccup timeout a soft-start is attempted. If OCP persists, hiccup timeout will repeat. The IC will remain in hiccup mode until load current is reduced below the programmed IOCP. In order to program overcurrent protection use the following equation:

$$RLIM = \frac{(IOCP \times RDS) + 8mV}{ILIM}$$

Where:

RLIM is resistor value for programming IOCP

IOCP is the overcurrent value to be programmed

RDS is the MOSFET rated on resistance

8mV is the OCP comparator offset

ILIM is the internal current that generates the necessary OCP comparator threshold (use 45uA)

Note that ILIM has a positive temperature coefficient of 0.4%/°C. This is meant to roughly match and compensate for positive temperature coefficient of the synchronous FET. In order for this feature to be effective the temperature rise of the IC should approximately match the temperature rise of the FET.

SHORT-CIRCUIT PROTECTION (SCP)

If the output voltage drops below 60% of its programmed value, the IC will enter hiccup mode. Hiccup will persist until short-circuit is removed. SCP circuit becomes active after PGOOD asserts high.

OVER-TEMPERATURE PROTECTION (OTP)

OTP triggers at a nominal die temperature of 150°C. The gate of switching FET and synchronous FET are turned off. When die temperature cools down to 135°C, softstart is initiated and operation resumes.

PROGRAMMING THE OUTPUT VOLTAGE

Use an external voltage divider as shown in figure 1 to program the output voltage VOUT.

$$R1 = R2 \times \left(\frac{VOUT}{0.6} - 1 \right)$$

R2 recommended range is 2kΩ to 10kΩ.

PROGRAMMING THE SOFTSTART

Place a capacitor CSS between the SS and GND pins to program the softstart. In order to program a softstart time of TSS, calculate the required capacitance CSS from the following equation:

$$CSS = TSS \times \frac{10uA}{0.6V}$$

FEED-FORWARD CAPACITOR CFF

A feed-forward capacitor CFF is recommended. CFF provides a low-impedance/high-frequency path for the output voltage ripple to be transmitted to FB. It also helps get an optimum load transient response. Calculate CFF from:

$$CFF = \frac{1}{2 \times \pi \times fs \times 0.1 \times R1}$$



A New Direction in Mixed-Signal

XRP6141

35A Synchronous Step Down COT Controller

Applications Circuit

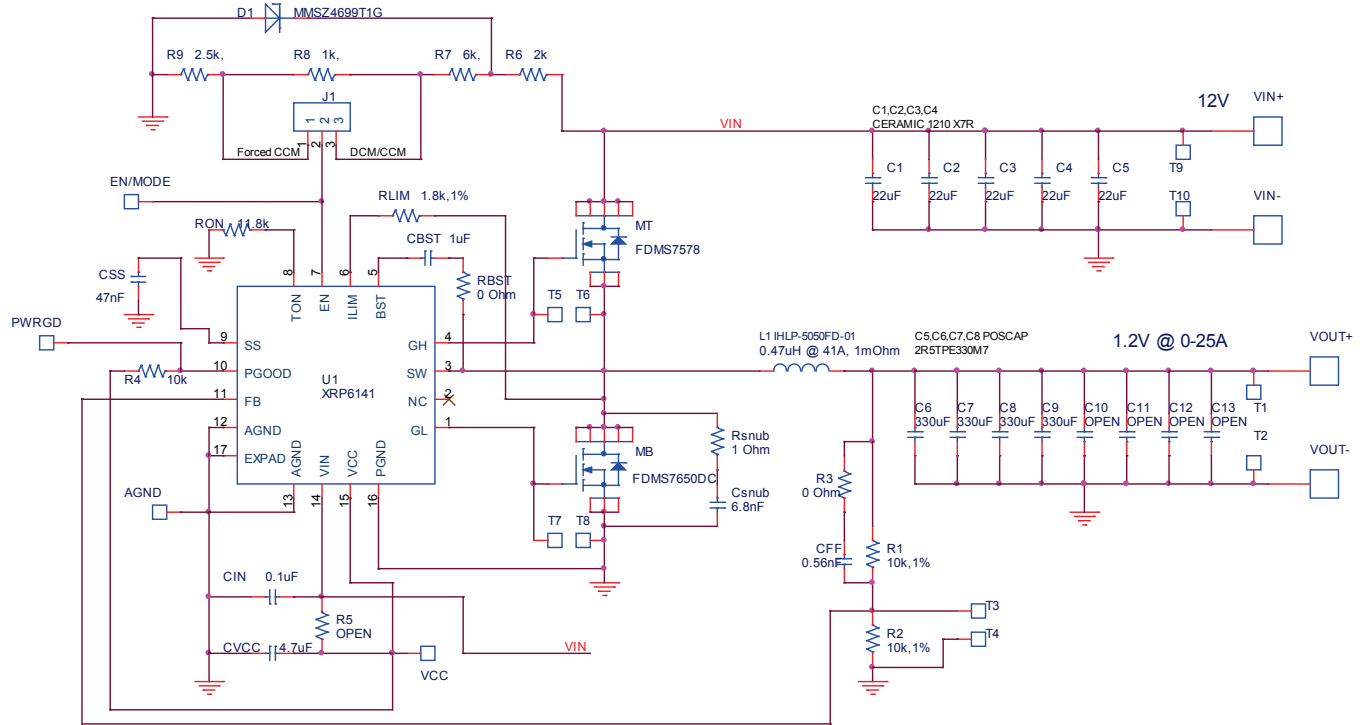

Note: If jumper J1 is set to CCM position, the converter will operate in 'Forced CCM' at $V_{IN}=12V(+/-10\%)$. In order to operate in Forced CCM over a wider V_{IN} range, remove Jumper and apply an auxiliary voltage in the 1.9V-3V range to the EN/MODE test point.

If jumper J1 is set to DCM/CCM position the converter will operate at DCM or CCM, depending on load, at $V_{IN}=12V(+/-10\%)$. In order to operate in DCM/CCM over a wider V_{IN} range, remove Jumper and apply an auxiliary voltage in the 3.1V-5V range to the EN/MODE test point.



A New Direction in Mixed-Signal

XRP6141

35A Synchronous Step Down COT Controller

PACKAGE SPECIFICATION

16 PIN 3X3 QFN

TOP VIEW

BOTTOM VIEW

SIDE VIEW

TERMINAL #1 INDEX AREA <D/2 X E/2>

TERMINAL #1 INDEX AREA <D/2 X E/2>

SEATING PLANE

θ (4X)

(A3)

REVISION HISTORY

REV.	DESCRIPTION	DATE	APP'D
A	DRAWING ORIGINATOR.	12/16/13	AD

SYMBOLS	DIMENSIONS IN MM (Control Unit)			DIMENSIONS IN INCH (Reference Unit)		
	MIN.	NOM.	MAX.	MIN.	NOM.	MAX.
A	0.80	0.90	1.00	0.032	0.036	0.039
A1	0.00	0.02	0.05	0.000	0.001	0.002
A3	0.20	REF		0.008	REF	
b	0.20	0.25	0.30	0.008	0.010	0.012
D	3.00	BSC		0.118	BSC	
D2	1.60	1.70	1.80	0.063	0.067	0.071
E	3.00	BSC		0.118	BSC	
E2	1.60	1.70	1.80	0.063	0.067	0.071
e	0.50	BSC		0.020	BSC	
L	0.15	0.25	0.35	0.005	0.009	0.013
K	0.20	—	—	0.008	—	—
q	0°	—	14°	0°	—	14°
N	—	—	—	—	—	—
ND	—	—	—	—	—	—
NE	—	—	—	—	—	—

16UD 3x3 QFN (OPTION 5) JEDEC MO-220 Variation VEED

EXAR CORPORATION

16 PIN 3x3 QFN PACKAGE OUTLINE (OPTION 5)

Packaging Approval: By: AD Date: 12/16/13 Revision: A Drawing No: POD-00000042 Sheet: 1 OF 1

ECN: 1351-04 12/16/2013

REVISION HISTORY

Revision	Date	Description
1.0.0	12/16/2013	Initial release
1.0.1	12/20/2013	Specification improvement

FOR FURTHER ASSISTANCE

Email:

customersupport@exar.com

powertechsupport@exar.com

Exar Technical Documentation:

<http://www.exar.com/TechDoc/default.aspx?>



EXAR CORPORATION

HEADQUARTERS AND SALES OFFICES

48720 Kato Road

Fremont, CA 94538 – USA

Tel.: +1 (510) 668-7000

Fax: +1 (510) 668-7030

www.exar.com

NOTICE

EXAR Corporation reserves the right to make changes to the products contained in this publication in order to improve design, performance or reliability. EXAR Corporation assumes no responsibility for the use of any circuits described herein, conveys no license under any patent or other right, and makes no representation that the circuits are free of patent infringement. Charts and schedules contained here in are only for illustration purposes and may vary depending upon a user's specific application. While the information in this publication has been carefully checked; no responsibility, however, is assumed for inaccuracies.

EXAR Corporation does not recommend the use of any of its products in life support applications where the failure or malfunction of the product can reasonably be expected to cause failure of the life support system or to significantly affect its safety or effectiveness. Products are not authorized for use in such applications unless EXAR Corporation receives, in writing, assurances to its satisfaction that: (a) the risk of injury or damage has been minimized; (b) the user assumes all such risks; (c) potential liability of EXAR Corporation is adequately protected under the circumstances.

Reproduction, in part or whole, without the prior written consent of EXAR Corporation is prohibited.



Компания «ЭлектроПласт» предлагает заключение долгосрочных отношений при поставках импортных электронных компонентов на взаимовыгодных условиях!

Наши преимущества:

- Оперативные поставки широкого спектра электронных компонентов отечественного и импортного производства напрямую от производителей и с крупнейших мировых складов;
- Поставка более 17-ти миллионов наименований электронных компонентов;
- Поставка сложных, дефицитных, либо снятых с производства позиций;
- Оперативные сроки поставки под заказ (от 5 рабочих дней);
- Экспресс доставка в любую точку России;
- Техническая поддержка проекта, помощь в подборе аналогов, поставка прототипов;
- Система менеджмента качества сертифицирована по Международному стандарту ISO 9001;
- Лицензия ФСБ на осуществление работ с использованием сведений, составляющих государственную тайну;
- Поставка специализированных компонентов (Xilinx, Altera, Analog Devices, Intersil, Interpoint, Microsemi, Aeroflex, Peregrine, Syfer, Eurofarad, Texas Instrument, Miteq, Cobham, E2V, MA-COM, Hittite, Mini-Circuits, General Dynamics и др.);

Помимо этого, одним из направлений компании «ЭлектроПласт» является направление «Источники питания». Мы предлагаем Вам помощь Конструкторского отдела:

- Подбор оптимального решения, техническое обоснование при выборе компонента;
- Подбор аналогов;
- Консультации по применению компонента;
- Поставка образцов и прототипов;
- Техническая поддержка проекта;
- Защита от снятия компонента с производства.



Как с нами связаться

Телефон: 8 (812) 309 58 32 (многоканальный)

Факс: 8 (812) 320-02-42

Электронная почта: org@eplast1.ru

Адрес: 198099, г. Санкт-Петербург, ул. Калинина, дом 2, корпус 4, литера А.