

# PLATO®





## Quality Tools for Electronics Assembly and Repair

ITW Chemtronics® is proud to offer Plato® tools for electronic soldering applications. Whether your requirements are for soldering tips, solder pots or cutters, Plato has the right solutions for your soldering requirements.

### Plato quality tools include:

- Replacement soldering tips
- Shear cutters
- Solder pots
- Solder accessories, sponges and flux bottles



## YOUR ONE SOURCE FOR SOLDERING TIPS

Plato is one of the largest manufacturers of soldering tips in the world, producing tips to fit all of the most popular soldering stations. The long life and fast heat recovery of Plato soldering tips increases soldering speed.

### Long Life

Proprietary iron plating is optimized for lead-free solders, increasing tip life.

### Rapid Heat Recovery

Plato soldering tips are constructed from highly conductive premium grade copper to transmit heat to the work more quickly. Rapid heat recovery enables more joints to be soldered per minute.

Constructed with high-grade copper for maximum heat conductivity.

Coated with a proprietary iron plating for long life.

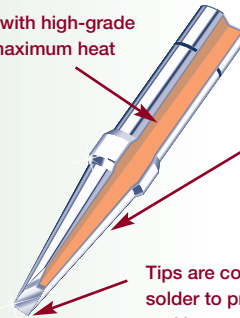

Tips are coated with lead-free solder to protect against oxidation and improve heat transfer.

### Toll-Free Customer Support:

**Tel: 1-800-645-5244**

### Need Technical Information?

Contact our Technical Hotline at:

1-800-TECH-401 (800-832-4401)

1-770-424-4888 ext 137

Email us at [AskChemtronics@chemtronics.com](mailto:AskChemtronics@chemtronics.com)

or visit us at [www.chemtronics.com](http://www.chemtronics.com)



We acknowledge the following trademarks: A.P.E.® is a registered trademark of Automated Production Equipment, Inc.; American Beauty® is a trademark of Assembly Technologies International, Inc.; Edsyn® is a registered trademark of Edsyn; Ersa® is a registered trademark of Ersa. Esico® is a trademark of Electronic Soldering Iron Co.; Hakko® is a registered trademark of Hakko Metal Industries, Ltd.; Loner® is a registered trademark of Edsyn; Metcal® is a registered trademark of O.K. Industries; Pace® is a registered trademark of Pace, Inc.; Hexacon® Select-O-Trac® and Therm-O-Trac® are registered trademarks of Hexacon Electric Co.; Weller® is a registered trademark of Cooper Industries, Inc.; Ungar® is a registered trademark of Ungar. Plato® is a registered trademark of Illinois Tool Works®. All rights reserved. Chemtronics® is a registered trademark of ITW Chemtronics®. All rights reserved.

All other trademarks or registered trademarks included herein are the trademarks or registered trademarks of their respective owners.

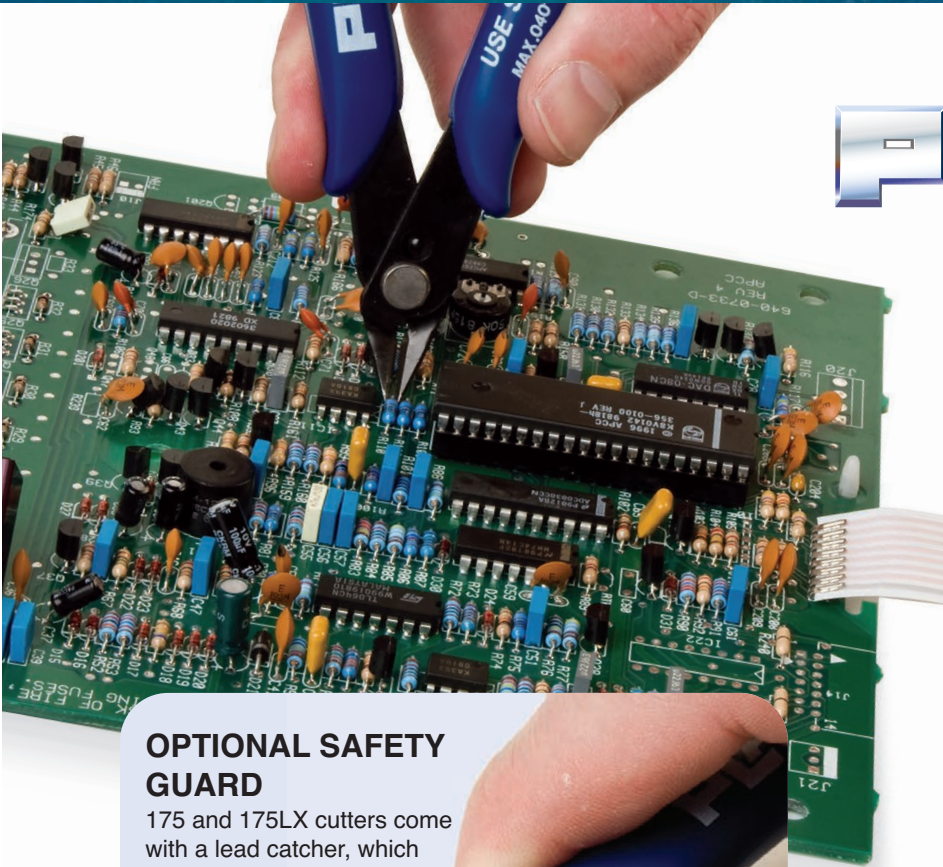

## LEAD CUTTERS

Plato cutters give you the precision of a high-end tool, but at a disposable cutter price. They flush cut component leads as large as 18 AWG copper wire (.040"/1.0mm).

Assemblers love the effortless shearing action, comfort, and safety. Plato cutters use the shear cutting method, which requires 50% less operator effort and extends cutting life.

The thin profile design is perfect for hard-to-reach areas in electronic assembly. Handles are cushioned for comfort all day, and automatically spring back to their original position after each use.

### OPTIONAL SAFETY GUARD

175 and 175LX cutters come with a lead catcher, which holds onto a trimmed lead until the shear is opened. This prevents leads from flying off, which can lead to eye injury or contaminate the assembly.

Safety Guard



### 170LX • 175LX

#### PLATOSHEAR LX

ERGONOMIC, ESD-SAFE LEAD CUTTER

Sculpted handle design made of ESD-safe material gives the Platoshear LX cutters the look and feel of a high-end shear cutter.

- Ergonomic handled designed for comfort
- ESD-safe handle to prevent static discharge

**170LX** 1 cutter, 10/case  
**175LX** 1 cutter w/safety guard, 10/case



### 170 • 175

#### PLATOSHEAR

GENERAL PURPOSE LEAD CUTTER

Our best-selling cutters! Precise, reliable cutting action at an economical price. Thin profile handle and light weight design is ideal for smaller hands.

- Economical, disposable cutter
- Thin blade profile for trimming in tight areas
- Ergonomic handle design
- Spring-back action

**170** 1 cutter, 10/case  
**175** 1 cutter w/safety guard, 10/case



### 1755

#### PLATO BIG SHEAR

HEAVY DUTY CUTTER

Cuts round and flat cable, co-ax, nickel, Kovar, and other wire with a clean shearing cut that reduces cable cut-end distortion. Lightweight design significantly reduces operator fatigue.

- For heavy gauge wire
- Cushioned rubber handles
- Spring-back action

**1755** 1 cutter, 10/case





## SOLDER POTS

Plato® solder pots are known around the world for their durable construction and precise controls. Ideal for tinning lead wires, pre-tinning small electrical parts, or dip soldering small assemblies and circuit devices.

### Porcelain Coated Crucibles

Plato's porcelain coated crucible is easy to clean and offers a long service life. Solder will not adhere to the porcelainized surface, allowing for easy maintenance. The coating also resists corrosion common with activated fluxes and high tin content solders. Ground stud is installed through coating to control ESD.



Solder beads off the porcelain coating like water on a freshly waxed car

### SP-101/P • SP-201P • SP301/P • SP401P GENERAL PURPOSE SOLDER POTS

Plato general purpose solder pots control temperature  $\pm 6^{\circ}\text{C}$  through the use of a thermal timer switch with automatic correction for voltage fluctuations.

- Safety heat shield & removable dross tray
- 64mm dia. x 38mm deep crucible
- 907g solder capacity
- Adjustable leveling feet
- All metal construction for ESD protection



| Product | Crucible              | Volts | Watts | Temp. Range   |
|---------|-----------------------|-------|-------|---------------|
| SP-101  | Uncoated Iron         | 120 Ⓢ | 350   | 260°C - 524°C |
| SP-101P | Porcelain Coated Iron | 120 Ⓢ | 350   | 260°C - 524°C |
| SO-201P | Porcelain Coated Iron | 240*  | 350   | 260°C - 524°C |
| SP-301  | Uncoated Iron         | 120 Ⓢ | 500   | 260°C - 593°C |
| SP-301P | Porcelain Coated Iron | 120 Ⓢ | 500   | 260°C - 593°C |
| SP-401P | Porcelain Coated Iron | 240*  | 500   | 260°C - 593°C |

\* 240V does not include plug. Power cable needs to have locally compatible plug stripped on.



### SP-500T/P • SP-150TP PRECISION ELECTRONIC SOLDER POTS

Plato's Precision Solder Pots exceed the requirements of military specifications ANSI J-STD-001B. The pots control temperatures to  $\pm 2.75^{\circ}\text{C}$  of a preselected setting and have an LCD temperature display. Designed for voltage sensitive components. Electronics compensate for incoming power fluctuations, limiting transient voltage spiking to 2mV peak-to-peak.

- High precision temperature control  $\pm 2.75^{\circ}\text{C}$
- LCD displays preset temperature and operating temperature
- Safety heat shield & removable dross tray
- 64mm dia. x 38mm deep crucible
- 907g solder capacity
- Adjustable leveling feet
- All metal construction for ESD protection

| Product  | Crucible              | Volts | Watts | Temp. Range     |
|----------|-----------------------|-------|-------|-----------------|
| SP-500T  | Uncoated Iron         | 120 Ⓢ | 350   | Ambient - 496°C |
| SP-500TP | Porcelain Coated Iron | 120 Ⓢ | 350   | Ambient - 496°C |
| SO-150TP | Porcelain Coated Iron | 240*  | 350   | Ambient - 496°C |

\* 240V does not include plug. Power cable needs to have locally compatible plug stripped on.

### SP-600TP • SP-750TP HIGH CAPACITY SOLDER POTS

High capacity pot for pre-tinning large assemblies and for use as a mini-wave. Precision electronic controls have the same features as listed above.

- 102mm width x 152mm length x 102mm deep crucible
- Large capacity – holds 14.5 kg of solder
- Safety crucible cover
- Adjustable leveling feet
- All metal construction



| Product  | Crucible              | Volts | Watts | Temp. Range     |
|----------|-----------------------|-------|-------|-----------------|
| SP-600TP | Porcelain Coated Iron | 120 Ⓢ | 1000  | Ambient - 399°C |
| SO-750TP | Porcelain Coated Iron | 240*  | 1000  | Ambient - 399°C |

\* 240V does not include plug. Power cable needs to have locally compatible plug stripped on.



## DISPENSING BOTTLES

Each bottle is available with standard plastic or with optional ESD-safe cover. Plato's ESD-safe bottles are surrounded by permanently static dissipative sleeves that stay out of contact with flux and other liquids. This prevents conductive "hot spots" on the surface of the bottle.

- Protects voltage sensitive devices from static discharge
- Meets ANSI J-STD-001B
- Meets the requirements of DOD-STD-1686 for containers
- Physical characteristics comply with MIL-B-81705, Type 2

## FD-2 • FD-21 • SD-01 • SD-02 NEEDLE FLUX DISPENSERS

Needle bottles are ideal for precisely controlled flux applications. Two different needle sizes are available: 0.25mm for low viscosity no-clean and aqueous fluxes, and 0.50mm for higher viscosity rosin-based fluxes.

- Dispense precise amount of flux without dripping, spilling, or waste
- Unique, no leak design

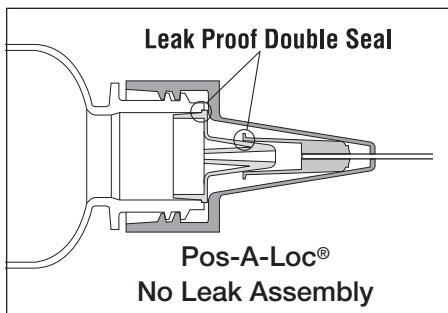

**0.25mm needle for  
No-Clean & Aqueous Fluxes**  
FD-21 1 bottle  
SF-01 1 bottle, ESD-safe

**0.50mm needle for  
Rosin-based Fluxes**  
FD-2 1 bottle  
SF-02 1 bottle, ESD-safe



## BC-250 • SF-250 WATER & LIQUID DISPENSING BOTTLES

Polyethylene bottle, screw cap, and dispensing tube with 237ml capacity. Inexpensive way to wet sponges and dispense liquids without waste at the work bench.

BC-250 1 bottle,  
SF-250 1 bottle, ESD-safe



## SB-2N • SF-B2HH BRUSH SCRUB BOTTLES

Brush bottles are a great way to aggressively but safely clean white flux residues, adhesives, and other difficult soils from electronic assemblies. Natural hog bristles are neutral charge and static dissipative when saturated.

- Inexpensive and safe method to spot clean PCB assemblies
- Compatible with IPA, hexane, and acetone

SB-2N 1 bottle  
SF-B2HH 1 bottle, ESD-safe



# SPONGES & TINNER



## REPLACEMENT SPONGES

Manufactured with pure cellulose (a wood derivative) which has the ability to absorb many times its weight in water. Also resistant to abrasion and tearing when wiping tips. Meets ANSI J-STD-001B for low sulphur content and fine porosity.

- Remove Surface Oxides
- Extend Tip Life
- Remove Excess Solder

Cheap synthetic sponges, like common household sponges, are not recommended for tip cleaning. They contain colorings, plasticizers, stiffeners, and other contaminants which will shorten tip life.

### CS-17 PLATO CUT-TO-FIT SHEET

For difficult to find sponge sizes or special applications, Plato offers full sheets of sponge material that can be trimmed to exact size.

**CS-17**—1 sheet, 216mm x 432mm x 25mm thick

**CS-17/625**—Thinner Economy Sponge (1 sheet, 216mm x 432mm x 16mm thick)



(SCISSORS NOT INCLUDED)

### CS-43 • CS-44/44M HAKKO COMPATIBLE REPLACEMENT SPONGES

**CS-43**—10 sponges/pack, 45mm x 102mm x 25mm thick  
Fits Hakko 926-029B



**CS-44**—10 sponges/pack, 69mm x 69mm x 25mm thick  
Fits Hakko 609-0229, A-1042

**CS-44M**—10 sponges/pack, 69mm x 69mm x 25mm thick  
Fits Hakko 609-0229, A-1042



### C-1 • CS-14/14M • CS-33 • CS-44/44M WELLER COMPATIBLE REPLACEMENT SPONGES



**C-1**—10 sponges/pack, 38mm x 54mm x 25mm thick  
Fits Weller SP-60

**CS-14**—10 sponges/pack, 55mm x 70mm x 25mm thick  
Fits Weller 52241999



**CS-14M**—10 sponges/pack, 55mm x 70mm x 25mm thick  
Fits Weller 52241999

**CS-33**—10 sponges/pack, 70mm x 114mm x 25mm thick  
Fits Weller EC-205



**CS-44**—10 sponges/pack, 69mm x 69mm x 25mm thick  
Fits Weller TC-205

**CS-44M**—10 sponges/pack, 69mm x 69mm x 25mm thick  
Fits Weller TC-205



### CS-47 METCAL & UNGAR COMPATIBLE REPLACEMENT SPONGES



**CS-47**—10 sponges/pack, 53mm x 81mm x 25mm thick  
Fits Metcal STSS-YS3 and Ungar 455, UTC234

### CS-36 HEXACON COMPATIBLE REPLACEMENT SPONGES

**CS-9/625**—10 sponges/pack, 89mm x 114mm x 16mm thick  
Fits Hexacon 8101, 8101C, 8121, 8121C



**CS-36**—10 sponges/pack, 57mm x 89mm x 25mm thick  
Fits Hexacon 8141, 8141C

### TT-95 TIP TINNER/TIP CLEANER



Plato's Tip Cleaner provides fast, efficient cleaning and re-tinning of highly oxidized soldering iron tips. This thermally-stable compound is lead-free, environmentally safe, and in an ESD-safe container. Tip Cleaner brings oxidized tips back to life, which improves soldering speed. Roll a hot soldering tip in the Tip Cleaner for a few seconds until the bright tinning surrounds the end of the tip.

- Extends tip life
- Lead-free
- Easy to use

**TT-95** 1 – 20g container, 10 per case



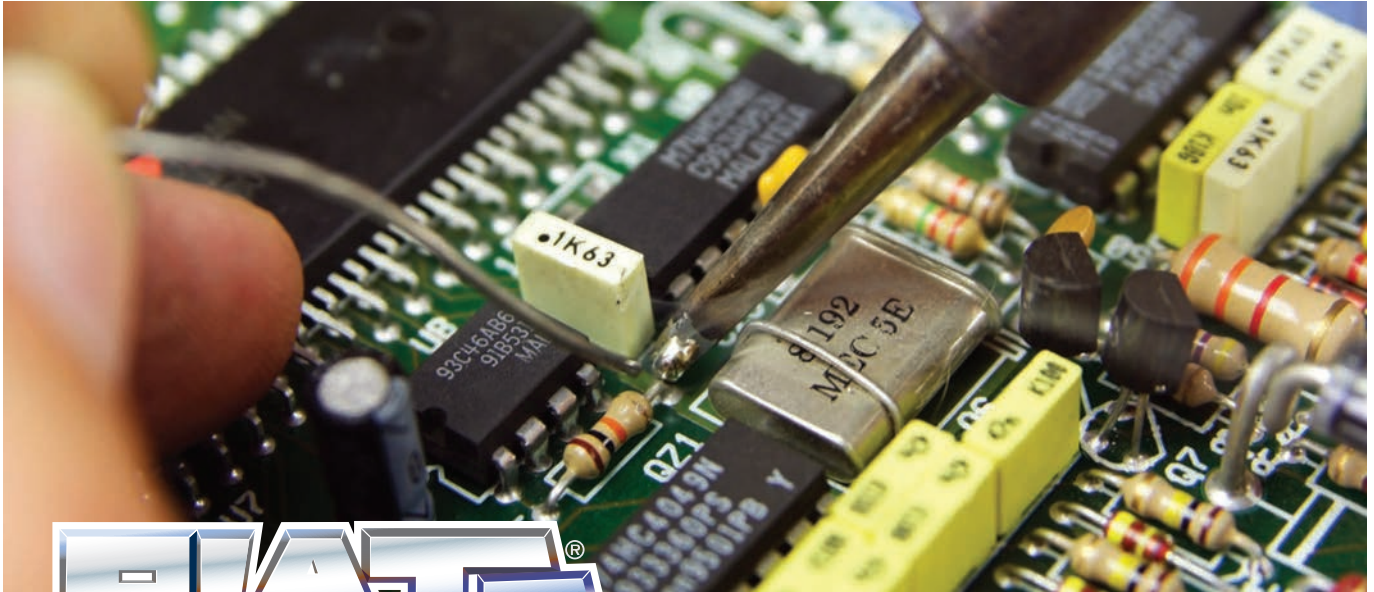

# PLATO®

## REPLACEMENT SOLDERING & DESOLDERING TIPS

Tip drawings are actual size

| Hakko®       | Plato®  | ( ) = mm     |
|--------------|---------|--------------|
| 900M-T-1C    | HS-5701 | 3/64" (1.2)  |
| 900M-T-2C    | HS-5702 | 5/64" (2.0)  |
| 900M-T-3C    | HS-5703 | 1/8" (3.0)   |
| 900M-T-4C    | HS-5875 | 5/32" (4.0)  |
| 900M-T-0.8D  | HS-2863 | 1/32" (0.8)  |
| 900M-T-1.2D  | HS-2796 | 3/64" (1.2)  |
| 900M-T-1.2LD | HS-6030 | 3/64" (1.2)  |
| 900M-T-1.6D  | HS-2751 | 1/16" (1.6)  |
| 900M-T-2.4D  | HS-2752 | 3/32" (2.4)  |
| 900M-T-3.2D  | HS-2753 | 1/8" (3.2)   |
| 900M-T-0.2RB | HS-4791 | 0.016" (0.4) |

Tip drawings are actual size

| Hakko®       | Plato®  | ( ) = mm                        |
|--------------|---------|---------------------------------|
| 900M-T-H     | HS-0925 | 30° 1/16" (1.6)                 |
| 900M-T-B     | HS-4785 | .040" (1.0)<br>.250" TIN LENGTH |
|              | HS-8179 | .040" (1.0)<br>.300" TIN LENGTH |
| 900M-T-LB    | HS-4786 | 1/64" (0.4)                     |
| 900M-T-1     | HS-4787 | 1/64" (0.8)                     |
| 900M-T-K     | HS-0927 | 3/16" (4.7)<br>1/4" (6.3)       |
| 900M-T-S1    | HS-2796 | 3/64" (1.2)                     |
| 900M-T-S3    | HS-1665 | 13/64" (5.2)                    |
| 900M-T-S4    | HS-8175 | .008" (0.2)                     |
| 900M-T-S5    | HS-8157 | 1/64" (0.4)                     |
| SMD Flow Tip | HS-0530 | .128" (3.3)<br>.118" (3.0)      |
| SMD Flow Tip | HS-0531 | .195" (5.0)<br>.135" (3.4)      |

Tip drawings are actual size

| Hakko®    | Plato®  | ( ) = mm   |
|-----------|---------|--|
| 900L-T-5C | HS-5876 |  |
| 900L-T-K  | HS-0922 | <br>SMD Tip to solder SOIC and PLCC<br>D1: .010\" (.2)<br>D2: .080\" (2.0) |

| Hakko®    | Plato®  | ( ) = mm |
|-----------|---------|----------|
| 900L-T-S1 | HS-1666 |          |

Tip drawings are actual size.

| Hakko® | Plato®  | D1 (mm)     | D2 (mm)     |
|--------|---------|-------------|-------------|
| A-1002 | HK-0878 | .030" (0.8) | .070" (1.8) |
| A-1003 | HK-0879 | .040" (1.0) | .080" (2.0) |
| A-1004 | HK-0880 | .030" (0.8) | .090" (2.3) |
| A-1005 | HK-0881 | .040" (1.0) | .100" (2.5) |
| A-1006 | HK-0882 | .050" (1.3) | .120" (3.0) |
| A-1007 | HK-0883 | .060" (1.5) | .120" (3.0) |

- Premium quality for long life
- Iron plated outside and stainless steel tube insert prevents solder path erosion
- All dimensions are shown before tinning and are subject to manufacturing tolerances

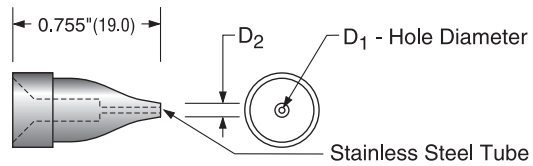

**LONG LIFE LEAD-FREE TIPS**

- Longer Life
- Designed for lead-free soldering
- Look for tips with an LF added to the end of the part number



| Weller® | Plato®  | ( ) = mm |
|---------|---------|----------|
| —       | MS-4140 |          |
| LT1     | MS-4120 |          |
| LT1L    | MS-4110 |          |
| LT1LX   | MS-4101 |          |
| LT1S    | MS-4100 |          |
| LT4W    | MS-5160 |          |

Tip drawings are actual size

| Weller®                   | Plato®               | ( ) = mm |
|---------------------------|----------------------|----------|
| LT4X                      | MS-3125              |          |
| LTA<br>LTA LF <b>NEW!</b> | MS-3200<br>MS-3200LF |          |
| LTB<br>LTB LF <b>NEW!</b> | MS-3300<br>MS-3300LF |          |
| LTC<br>LTC LF <b>NEW!</b> | MS-3400<br>MS-3400LF |          |
| LTD<br>LTD LF <b>NEW!</b> | MS-3600<br>MS-3600LF |          |



Be sure to add temperature indicating number to Plato® part number when ordering Plato® C-Tips.

Choose the desired temperature and add it to the end of the Plato part number\* (Example C-3039-7)

| Desired Temperature | Suffix to Add to Plato Part Number |
|---------------------|------------------------------------|
| 700°F / 370°C       | -7                                 |
| 800°F / 425°C       | -8                                 |
| 900°F / 480°C       | -9                                 |

Tip drawings are actual size

| Weller® | Plato® | ( ) = mm    |
|---------|--------|-------------|
| PTA     | C-3039 | 1/16" (1.6) |
| PTB     | C-3040 | 3/32" (2.4) |
| PTC     | C-3036 | 1/8" (3.2)  |
| PTD     | C-1016 | 3/16" (4.8) |
| PTF     | C-593  | 1/32" (0.8) |
| PTH     | C-3100 | 1/32" (0.8) |

Tip drawings are actual size

| Weller® | Plato® | ( ) = mm    |
|---------|--------|-------------|
| PTK     | C-3043 | 3/64" (1.2) |
| PTL     | C-3044 | 5/64" (2.0) |
| PTM     | C-3102 | 1/8" (3.2)  |
| PTO     | C-4223 | 1/32" (0.8) |
| PTP     | C-462  | 1/32" (0.8) |
| PTS     | C-494  | 1/64" (0.4) |
| PTBB    | C-5143 | 3/32" (2.4) |
| PTCC    | C-5141 | 1/8" (3.2)  |

\*Indicated temperature ranges are nominal and will vary according to style of tip, condition of iron, manner of use, and other variables. All dimensions are shown before tinning and are subject to manufacturing tolerances.

Tip drawings are actual size.

| Weller®                        | Plato®               | ( ) = mm                  |
|--------------------------------|----------------------|---------------------------|
| LTGW<br>LTGW LF<br><b>NEW!</b> | MS-0100<br>MS-0100LF | .122" (3.1) / .084" (2.1) |
| LTH                            | MS-3110              | .031" (0.8)               |
| LTHX                           | MS-3101              | .024" (0.6) / .016" (0.4) |
| LTK                            | MS-3150              | .050" (1.3) / .020" (0.5) |
| LTL                            | MS-3250              | .079" (2.0) / .039" (1.0) |
| LTM                            | MS-3450              | .125" (3.2) / .047" (1.2) |

Tip drawings are actual size.

| Weller®                | Plato®    | ( ) = mm  |
|------------------------|-----------|---|
| LTS                    | MS-4130   | .018" (0.5)   |
| LTO LF<br><b>NEW!</b>  | MS-4200LF | 0.039" (0.9)  |
| LTBB LF<br><b>NEW!</b> | MS-5300LF | 0.094" (2.4)  |
| LTCC LF<br><b>NEW!</b> | MS-5400LF | 0.125" (3.2)  |
| LTKN LF<br><b>NEW!</b> | MS-0201LF | 0.162" (4.0) / 0.228" (5.7) / 0.002" (0.05) / 0.06" (1.5) |

Tip drawings not actual size

| Weller® | Plato®  | ( ) = mm                                |
|---------|---------|---|
| ETA     | EW-303  | 1/16" (1.6)                             |
| ETB     | EW-305  | 3/32" (2.4)                             |
| ETC     | EW-307  | 1/8" (3.2)                              |
| ETD     | EW-103  | 3/16" (4.8)                             |
| ETE     | EW-105  | 7/32" (5.6)                             |
| ETGW    | EW-0574 | .195" (5.0) SMD Flow Tip<br>.135" (3.4) |
| ETH     | EW-301  | 1/32" (0.8)                             |
| ETJ     | EW-302  | 1/32" (0.8)                             |
| ETK     | EW-304  | 3/64" (1.2)                             |
| ETL     | EW-306  | 5/64" (2.0)                             |
| ETM     | EW-308  | 1/8" (3.2)                              |

| Weller® | Plato®  | ( ) = mm                       |
|---------|---------|--------------------------------|
| ETO     | EW-404  | 1/32" (0.8)                    |
| ETP     | EW-403  | 1/32" (0.8)                    |
| ETR     | EW-101  | 1/16" (1.6)                    |
| ETS     | EW-402  | .012" (0.3)                    |
| ETT     | EW-401  | 1/64" (0.4)                    |
| ETV     | EW-511  | .025" (0.6)                    |
|         | EW-0602 | .020" (0.5) SMD<br>.031" (0.8) |
| ETAA    | EW-513  | 1/32" (0.8)                    |
| ETBB    | EW-515  | 1/16" (1.6)                    |
| ETCC    | EW-517  | 3/32" (2.4)                    |
|         |         | 1/8" (3.2)                     |

**PACE®**

Desoldering Tips to Replace Pace Endura Tips  
 Desoldering Irons SX90, SX-80 and SX-70 with Paper Chamber 3/16" Diameter

| Pace®     | Plato®  | ID (mm)    | OD (mm)    |
|-----------|---------|------------|------------|
| 1121-0625 | 30-0301 | .03" (0.8) | .08" (2.0) |
| 1121-0624 | 30-0401 | .04" (1.0) | .09" (2.3) |
| 1121-0626 | 30-0601 | .06" (1.5) | .12" (3.1) |
| 1121-0627 | 30-0901 | .09" (2.3) | .20" (5.1) |
| 1121-0628 | 30-1003 | .03" (0.8) | .09" (2.3) |
| 1121-0629 | 30-1004 | .04" (1.0) | .10" (2.5) |
| 1121-0630 | 30-1006 | .06" (1.5) | .12" (3.1) |
| 1121-0681 | 30-1020 | .02" (0.5) | .07" (1.8) |
| 1121-0682 | 30-1030 | .03" (0.8) | .08" (2.0) |
| 1121-0683 | 30-1040 | .04" (1.0) | .09" (2.3) |
| 1121-0631 | 30-1060 | .06" (1.5) | .19" (4.8) |
| 1121-0680 | 30-1200 | .02" (0.5) | .07" (1.8) |
| 1121-0678 | 30-1300 | .03" (0.8) | .08" (2.0) |
| 1121-0679 | 30-1400 | .04" (1.0) | .09" (2.3) |
| 1121-0690 | 30-1600 | .06" (1.5) | .11" (2.8) |



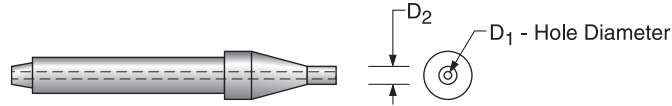

| Pace®     | Plato®  | D1 (mm)     | D2 (mm)     |
|-----------|---------|-------------|-------------|
| 1121-0342 | 30-0400 | .040" (1.0) | .085" (2.2) |
| 1121-0463 | 30-040  | .040" (1.0) | .085" (2.2) |
| ---       | 30-050  | .050" (1.3) | .095" (2.4) |

| Pace®     | Plato®  | D1 (mm)     | D2 (mm)     |
|-----------|---------|-------------|-------------|
| 1121-0368 | 30-0600 | .060" (1.5) | .115" (2.9) |
| 1121-0464 | 30-060  | .060" (1.5) | .115" (2.9) |
| 1121-0507 | 30-0900 | .090" (2.3) | .190" (4.8) |

Desoldering Irons • Pace® • Air-Vac® • A.P.E.

**AIR-VAC®**

**A.P.E.®**

**PACE®**

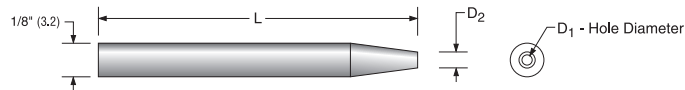

| Pace®   | Plato®  | L (mm)       | D1 (mm)     | D2 (mm)     |
|---|---------|--------------|-------------|-------------|
| <b>Plato® Tips to fit Pace® SX-20, SX-25, SX-25V SODR-X-TRACTORS®</b> |         |              |             |             |
| 1121-0480   | 20-0114 | 1.00" (25.4) | .030" (0.8) | .060" (1.5) |
| ---   | 20-0815 | 1.00" (25.4) | .036" (0.9) | .065" (1.7) |
| 1121-0479   | 20-0110 | 1.00" (25.4) | .040" (1.0) | .080" (2.0) |
| 1121-0216   | 20-0113 | 1.00" (25.4) | .050" (1.3) | .090" (2.3) |
| 1121-0217   | 20-0111 | 1.00" (25.4) | .060" (1.5) | .100" (2.5) |

| Pace®   | Plato® | L (mm)       | D1 (mm)     | D2 (mm)     |
|---|--------|--------------|-------------|-------------|
| <b>Plato® Tips to fit Pace® SX-40A, SX-55A, SX-65A, SX-70 SODR-X-TRACTORS® with Plato Adapter 33-0001</b> |        |              |             |             |
| 1121-0485   | 20-025 | 1.75" (44.5) | .030" (0.8) | .080" (2.0) |
| 1121-0486   | 20-040 | 1.75" (44.5) | .040" (1.0) | .080" (2.0) |
| 1121-0255   | 20-060 | 1.75" (44.5) | .060" (1.5) | .100" (2.5) |

Soldering Stations • SMT 60 • Digital 2000 with Micro Tool  
Twin 80 A with Micro Tool

**ERSA®**

Tip drawings are actual size

| Ersa® | Plato®  | ( ) = mm     |
|-------|---------|--------------|
| 212BD | ER-4007 | 0.004" (0.1) |

| Ersa® | Plato®  | ( ) = mm    |
|-------|---------|-------------|
| 212SD | ER-4001 | 0.06" (1.6) |

Soldering Stations • 203 • 203H • 204 • 204H

**QUICK**

Tip drawings are actual size

| Quick    | Plato®       | ( ) = mm             |
|----------|--------------|----------------------|
| 200-1C   | NEW! DN-1C   | 1 mm                 |
| 200-2.4D | NEW! DN-2.4D | 2.4 mm, 0.028" (0.7) |
| 200-3C   | NEW! DN-3C   | 3.0 mm               |

| Quick  | Plato®     | ( ) = mm                     |
|--------|------------|------------------------------|
| 200-B  | NEW! DN-B  | 1 mm                         |
| 200-K  | NEW! DN-K  | 5 mm, 6.8 mm, 0.1 mm, 2 mm   |
| 200-SK | NEW! DN-SK | 3 mm, 3.8 mm, 0.1 mm, 1.6 mm |



## TIP CROSS REFERENCE

| Ersa® | Plato®  | Pg. |
|-------|---------|-----|
| 212BD | ER-4007 | 11  |
| 212SD | ER-4001 | 11  |

| Hakko®       | Plato®  | Pg. |
|--------------|---------|-----|
| 900L-T-5C    | HS-5876 | 8   |
| 900L-T-K     | HS-0922 | 8   |
| 900L-T-S1    | HS-1666 | 8   |
| 900M-T-0.2RB | HS-4791 | 7   |
| 900M-T-0.8D  | HS-2863 | 7   |
| 900M-T-1.2D  | HS-2796 | 7   |
| 900M-T-1.2LD | HS-6030 | 7   |
| 900M-T-1.6D  | HS-2751 | 7   |
| 900M-T-1.8H  | HS-0926 | 7   |
| 900M-T-1C    | HS-5701 | 7   |
| 900M-T-2.4D  | HS-2752 | 7   |
| 900M-T-2C    | HS-5702 | 7   |
| 900M-T-3.2D  | HS-2753 | 7   |
| 900M-T-3C    | HS-5703 | 7   |
| 900M-T-4C    | HS-5875 | 7   |
| 900M-T-B     | HS-4785 | 7   |
| 900M-T-H     | HS-0925 | 7   |
| 900M-T-1     | HS-4787 | 7   |
| 900M-T-K     | HS-0927 | 7   |
| 900M-T-LB    | HS-4786 | 7   |
| 900M-T-S1    | HS-2796 | 7   |
| 900M-T-S3    | HS-1665 | 7   |
| 900M-T-S4    | HS-8175 | 7   |
| 900M-T-S5    | HS-8157 | 7   |
| A-1002       | HK-0878 | 8   |
| A-1003       | HK-0879 | 8   |
| A-1004       | HK-0880 | 8   |
| A-1005       | HK-0881 | 8   |
| A-1006       | HK-0882 | 8   |
| A-1007       | HK-0883 | 8   |
| SMD Flow Tip | HS-0530 | 8   |
| SMD Flow Tip | HS-0531 | 8   |

| Pace®     | Plato®  | Pg. |
|-----------|---------|-----|
| 1121-0216 | 20-0113 | 11  |
| 1121-0217 | 20-0111 | 11  |
| 1121-0255 | 20-060  | 11  |
| 1121-0342 | 30-0400 | 11  |
| 1121-0368 | 30-0600 | 11  |
| 1121-0463 | 30-040  | 11  |
| 1121-0464 | 30-060  | 11  |
| 1121-0479 | 20-0110 | 11  |

|           |         |    |
|-----------|---------|----|
| 1121-0480 | 20-0114 | 11 |
| 1121-0485 | 20-025  | 11 |
| 1121-0486 | 20-040  | 11 |
| 1121-0507 | 30-0900 | 11 |
| 1121-0624 | 30-0401 | 10 |
| 1121-0625 | 30-0301 | 10 |
| 1121-0626 | 30-0601 | 10 |
| 1121-0627 | 30-0901 | 10 |
| 1121-0628 | 30-1003 | 10 |
| 1121-0629 | 30-1004 | 10 |
| 1121-0630 | 30-1006 | 10 |
| 1121-0631 | 30-1060 | 10 |
| 1121-0678 | 30-1300 | 10 |
| 1121-0679 | 30-1400 | 10 |
| 1121-0680 | 30-1200 | 10 |
| 1121-0681 | 30-1020 | 10 |
| 1121-0682 | 30-1030 | 10 |
| 1121-0683 | 30-1040 | 10 |
| 1121-0690 | 30-1600 | 10 |

| Quick    | Plato®  | Pg. |
|----------|---------|-----|
| 200-1C   | DN-1C   | 11  |
| 200-2.4D | DN-2.4D | 11  |
| 200-3C   | DN-3C   | 11  |
| 200-B    | DN-B    | 11  |
| 200-K    | DN-K    | 11  |
| 200-SK   | DN-SK   | 11  |

| Weller® | Plato®  | Pg. |
|---------|---------|-----|
| ETA     | EW-303  | 10  |
| ETAA    | EW-513  | 10  |
| ETB     | EW-305  | 10  |
| ETBB    | EW-515  | 10  |
| ETC     | EW-307  | 10  |
| ETCC    | EW-517  | 10  |
| ETD     | EW-103  | 10  |
| ETE     | EW-105  | 10  |
| ETGW    | EW-0574 | 10  |
| ETH     | EW-301  | 10  |
| ETJ     | EW-302  | 10  |
| ETK     | EW-304  | 10  |
| ETL     | EW-306  | 10  |
| ETM     | EW-308  | 10  |
| ETO     | EW-404  | 10  |
| ETP     | EW-403  | 10  |
| ETR     | EW-101  | 10  |
| ETS     | EW-402  | 10  |

|         |           |    |
|---------|-----------|----|
| ETT     | EW-401    | 10 |
| ETV     | EW-511    | 10 |
| LT1     | MS-4120   | 8  |
| LT1L    | MS-4110   | 8  |
| LT1LX   | MS-4101   | 8  |
| LT1S    | MS-4100   | 8  |
| LT4W    | MS-5160   | 8  |
| LT4X    | MS-3125   | 8  |
| LTA     | MS-3200   | 8  |
| LTA LF  | MS-3200LF | 8  |
| LTB     | MS-3300   | 8  |
| LTB LF  | MS-3300LF | 8  |
| LTBB LF | MS-5300LF | 8  |
| LTC     | MS-3400   | 8  |
| LTC LF  | MS-3400LF | 8  |
| LTCC LF | MS-5400LF | 8  |
| LTD     | MS-3600   | 8  |
| LTD LF  | MS-3600LF | 8  |
| LTGW    | MS-0100   | 9  |
| LTGW LF | MS-0100LF | 9  |
| LTH     | MS-3110   | 9  |
| LTHX    | MS-3101   | 9  |
| LTK     | MS-3150   | 9  |
| LTKN LF | MS-0201LF | 9  |
| LTL     | MS-3250   | 9  |
| LTM     | MS-3450   | 9  |
| LTO LF  | MS-4200LF | 9  |
| LTS     | MS-4130   | 9  |
| LTBB LF | MS-5300LF | 9  |
| LTCC LF | MS-5400LF | 9  |
| LTKN LF | MS-0201LF | 9  |
| PTA*    | C-3039    | 9  |
| PTB*    | C-3040    | 9  |
| PTBB*   | C-5143    | 9  |
| PTC*    | C-3036    | 9  |
| PTCC*   | C-5141    | 9  |
| PTD*    | C-1016    | 9  |
| PTF*    | C-593     | 9  |
| PTH*    | C-3100    | 9  |
| PTK*    | C-3043    | 9  |
| PTL*    | C-3044    | 9  |
| PTM*    | C-3102    | 9  |
| PTO*    | C-4223    | 9  |
| PTP*    | C-462     | 9  |
| PTS*    | C-494     | 9  |

\*A temperature designating number is used by both Plato and Weller, e.g. Weller PTA7 is equivalent to Plato C-3039-7

**TW Chemtronics®**

8125 Cobb Center Drive ■ Kennesaw, GA 30152-4386  
 Tel: 770-424-4888 ■ Toll Free: 1-800-645-5244  
 Fax: 770-423-0748 ■ Toll Free Fax: 1-800-243-6003  
 www.chemtronics.com



platoproducts.com





Компания «ЭлектроПласт» предлагает заключение долгосрочных отношений при поставках импортных электронных компонентов на взаимовыгодных условиях!

Наши преимущества:

- Оперативные поставки широкого спектра электронных компонентов отечественного и импортного производства напрямую от производителей и с крупнейших мировых складов;
- Поставка более 17-ти миллионов наименований электронных компонентов;
- Поставка сложных, дефицитных, либо снятых с производства позиций;
- Оперативные сроки поставки под заказ (от 5 рабочих дней);
- Экспресс доставка в любую точку России;
- Техническая поддержка проекта, помощь в подборе аналогов, поставка прототипов;
- Система менеджмента качества сертифицирована по Международному стандарту ISO 9001;
- Лицензия ФСБ на осуществление работ с использованием сведений, составляющих государственную тайну;
- Поставка специализированных компонентов (Xilinx, Altera, Analog Devices, Intersil, Interpoint, Microsemi, Aeroflex, Peregrine, Syfer, Eurofarad, Texas Instrument, Miteq, Cobham, E2V, MA-COM, Hittite, Mini-Circuits, General Dynamics и др.);

Помимо этого, одним из направлений компании «ЭлектроПласт» является направление «Источники питания». Мы предлагаем Вам помощь Конструкторского отдела:

- Подбор оптимального решения, техническое обоснование при выборе компонента;
- Подбор аналогов;
- Консультации по применению компонента;
- Поставка образцов и прототипов;
- Техническая поддержка проекта;
- Защита от снятия компонента с производства.



#### Как с нами связаться

**Телефон:** 8 (812) 309 58 32 (многоканальный)

**Факс:** 8 (812) 320-02-42

**Электронная почта:** [org@eplast1.ru](mailto:org@eplast1.ru)

**Адрес:** 198099, г. Санкт-Петербург, ул. Калинина, дом 2, корпус 4, литера А.