

PLATO®





Quality Tools for Electronics Assembly and Repair

ITW Chemtronics® is proud to offer Plato® tools for electronic soldering applications. Whether your requirements are for soldering tips, solder pots or cutters, Plato has the right solutions for your soldering requirements.

Plato quality tools include:

- Replacement soldering tips
- Shear cutters
- Solder pots
- Solder accessories, sponges and flux bottles



YOUR ONE SOURCE FOR SOLDERING TIPS

Plato is one of the largest manufacturers of soldering tips in the world, producing tips to fit all of the most popular soldering stations. The long life and fast heat recovery of Plato soldering tips increases soldering speed.

Long Life

Proprietary iron plating is optimized for lead-free solders, increasing tip life.

Rapid Heat Recovery

Plato soldering tips are constructed from highly conductive premium grade copper to transmit heat to the work more quickly. Rapid heat recovery enables more joints to be soldered per minute.

Constructed with high-grade copper for maximum heat conductivity.

Coated with a proprietary iron plating for long life.

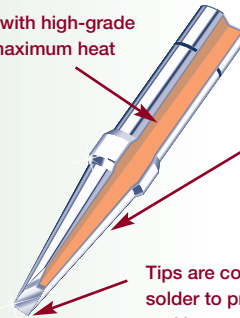

Tips are coated with lead-free solder to protect against oxidation and improve heat transfer.

Toll-Free Customer Support:

Tel: 1-800-645-5244

Need Technical Information?

Contact our Technical Hotline at:

1-800-TECH-401 (800-832-4401)

1-770-424-4888 ext 137

Email us at AskChemtronics@chemtronics.com

or visit us at www.chemtronics.com



We acknowledge the following trademarks: A.P.E.® is a registered trademark of Automated Production Equipment, Inc.; American Beauty® is a trademark of Assembly Technologies International, Inc.; Edsyn® is a registered trademark of Edsyn; Ersa® is a registered trademark of Ersa. Esico® is a trademark of Electronic Soldering Iron Co.; Hakko® is a registered trademark of Hakko Metal Industries, Ltd.; Loner® is a registered trademark of Edsyn; Metcal® is a registered trademark of O.K. Industries; Pace® is a registered trademark of Pace, Inc.; Hexacon® Select-O-Trac® and Therm-O-Trac® are registered trademarks of Hexacon Electric Co.; Weller® is a registered trademark of Cooper Industries, Inc.; Ungar® is a registered trademark of Ungar. Plato® is a registered trademark of Illinois Tool Works®. All rights reserved. Chemtronics® is a registered trademark of ITW Chemtronics®. All rights reserved.

All other trademarks or registered trademarks included herein are the trademarks or registered trademarks of their respective owners.

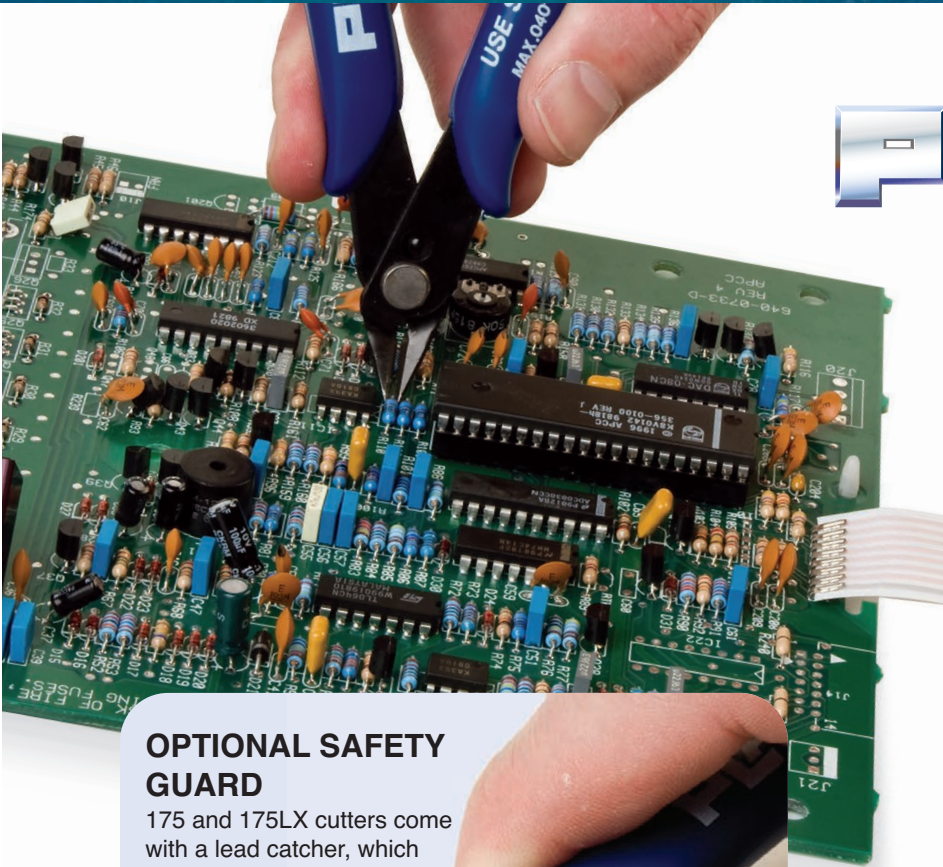

LEAD CUTTERS

Plato cutters give you the precision of a high-end tool, but at a disposable cutter price. They flush cut component leads as large as 18 AWG copper wire (.040"/1.0mm).

Assemblers love the effortless shearing action, comfort, and safety. Plato cutters use the shear cutting method, which requires 50% less operator effort and extends cutting life.

The thin profile design is perfect for hard-to-reach areas in electronic assembly. Handles are cushioned for comfort all day, and automatically spring back to their original position after each use.

OPTIONAL SAFETY GUARD

175 and 175LX cutters come with a lead catcher, which holds onto a trimmed lead until the shear is opened. This prevents leads from flying off, which can lead to eye injury or contaminate the assembly.

Safety Guard



170LX • 175LX

PLATOSHEAR LX

ERGONOMIC, ESD-SAFE LEAD CUTTER

Sculpted handle design made of ESD-safe material gives the Platoshear LX cutters the look and feel of a high-end shear cutter.

- Ergonomic handled designed for comfort
- ESD-safe handle to prevent static discharge

170LX 1 cutter, 10/case
175LX 1 cutter w/safety guard, 10/case



170 • 175

PLATOSHEAR

GENERAL PURPOSE LEAD CUTTER

Our best-selling cutters! Precise, reliable cutting action at an economical price. Thin profile handle and light weight design is ideal for smaller hands.

- Economical, disposable cutter
- Thin blade profile for trimming in tight areas
- Ergonomic handle design
- Spring-back action

170 1 cutter, 10/case
175 1 cutter w/safety guard, 10/case



1755

PLATO BIG SHEAR

HEAVY DUTY CUTTER

Cuts round and flat cable, co-ax, nickel, Kovar, and other wire with a clean shearing cut that reduces cable cut-end distortion. Lightweight design significantly reduces operator fatigue.

- For heavy gauge wire
- Cushioned rubber handles
- Spring-back action

1755 1 cutter, 10/case





SOLDER POTS

Plato® solder pots are known around the world for their durable construction and precise controls. Ideal for tinning lead wires, pre-tinning small electrical parts, or dip soldering small assemblies and circuit devices.

Porcelain Coated Crucibles

Plato's porcelain coated crucible is easy to clean and offers a long service life. Solder will not adhere to the porcelainized surface, allowing for easy maintenance. The coating also resists corrosion common with activated fluxes and high tin content solders. Ground stud is installed through coating to control ESD.



Solder beads off the porcelain coating like water on a freshly waxed car

SP-101/P • SP-201P • SP301/P • SP401P GENERAL PURPOSE SOLDER POTS

Plato general purpose solder pots control temperature $\pm 6^{\circ}\text{C}$ through the use of a thermal timer switch with automatic correction for voltage fluctuations.

- Safety heat shield & removable dross tray
- 64mm dia. x 38mm deep crucible
- 907g solder capacity
- Adjustable leveling feet
- All metal construction for ESD protection



Product	Crucible	Volts	Watts	Temp. Range
SP-101	Uncoated Iron	120 Ⓢ	350	260°C - 524°C
SP-101P	Porcelain Coated Iron	120 Ⓢ	350	260°C - 524°C
SO-201P	Porcelain Coated Iron	240*	350	260°C - 524°C
SP-301	Uncoated Iron	120 Ⓢ	500	260°C - 593°C
SP-301P	Porcelain Coated Iron	120 Ⓢ	500	260°C - 593°C
SP-401P	Porcelain Coated Iron	240*	500	260°C - 593°C

* 240V does not include plug. Power cable needs to have locally compatible plug stripped on.



SP-500T/P • SP-150TP PRECISION ELECTRONIC SOLDER POTS

Plato's Precision Solder Pots exceed the requirements of military specifications ANSI J-STD-001B. The pots control temperatures to $\pm 2.75^{\circ}\text{C}$ of a preselected setting and have an LCD temperature display. Designed for voltage sensitive components. Electronics compensate for incoming power fluctuations, limiting transient voltage spiking to 2mV peak-to-peak.

- High precision temperature control $\pm 2.75^{\circ}\text{C}$
- LCD displays preset temperature and operating temperature
- Safety heat shield & removable dross tray
- 64mm dia. x 38mm deep crucible
- 907g solder capacity
- Adjustable leveling feet
- All metal construction for ESD protection

Product	Crucible	Volts	Watts	Temp. Range
SP-500T	Uncoated Iron	120 Ⓢ	350	Ambient - 496°C
SP-500TP	Porcelain Coated Iron	120 Ⓢ	350	Ambient - 496°C
SO-150TP	Porcelain Coated Iron	240*	350	Ambient - 496°C

* 240V does not include plug. Power cable needs to have locally compatible plug stripped on.

SP-600TP • SP-750TP HIGH CAPACITY SOLDER POTS

High capacity pot for pre-tinning large assemblies and for use as a mini-wave. Precision electronic controls have the same features as listed above.

- 102mm width x 152mm length x 102mm deep crucible
- Large capacity – holds 14.5 kg of solder
- Safety crucible cover
- Adjustable leveling feet
- All metal construction



Product	Crucible	Volts	Watts	Temp. Range
SP-600TP	Porcelain Coated Iron	120 Ⓢ	1000	Ambient - 399°C
SO-750TP	Porcelain Coated Iron	240*	1000	Ambient - 399°C

* 240V does not include plug. Power cable needs to have locally compatible plug stripped on.



DISPENSING BOTTLES

Each bottle is available with standard plastic or with optional ESD-safe cover. Plato's ESD-safe bottles are surrounded by permanently static dissipative sleeves that stay out of contact with flux and other liquids. This prevents conductive "hot spots" on the surface of the bottle.

- Protects voltage sensitive devices from static discharge
- Meets ANSI J-STD-001B
- Meets the requirements of DOD-STD-1686 for containers
- Physical characteristics comply with MIL-B-81705, Type 2

FD-2 • FD-21 • SD-01 • SD-02 NEEDLE FLUX DISPENSERS

Needle bottles are ideal for precisely controlled flux applications. Two different needle sizes are available: 0.25mm for low viscosity no-clean and aqueous fluxes, and 0.50mm for higher viscosity rosin-based fluxes.

- Dispense precise amount of flux without dripping, spilling, or waste
- Unique, no leak design

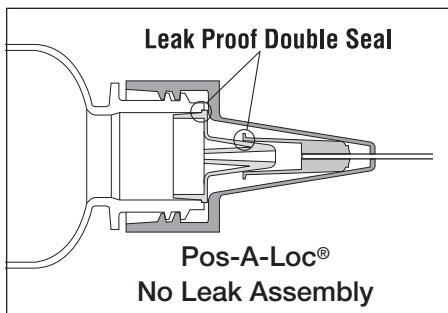

**0.25mm needle for
No-Clean & Aqueous Fluxes**
FD-21 1 bottle
SF-01 1 bottle, ESD-safe

**0.50mm needle for
Rosin-based Fluxes**
FD-2 1 bottle
SF-02 1 bottle, ESD-safe



BC-250 • SF-250 WATER & LIQUID DISPENSING BOTTLES

Polyethylene bottle, screw cap, and dispensing tube with 237ml capacity. Inexpensive way to wet sponges and dispense liquids without waste at the work bench.

BC-250 1 bottle,
SF-250 1 bottle, ESD-safe



SB-2N • SF-B2HH BRUSH SCRUB BOTTLES

Brush bottles are a great way to aggressively but safely clean white flux residues, adhesives, and other difficult soils from electronic assemblies. Natural hog bristles are neutral charge and static dissipative when saturated.

- Inexpensive and safe method to spot clean PCB assemblies
- Compatible with IPA, hexane, and acetone

SB-2N 1 bottle
SF-B2HH 1 bottle, ESD-safe



SPONGES & TINNER



REPLACEMENT SPONGES

Manufactured with pure cellulose (a wood derivative) which has the ability to absorb many times its weight in water. Also resistant to abrasion and tearing when wiping tips. Meets ANSI J-STD-001B for low sulphur content and fine porosity.

- Remove Surface Oxides
- Extend Tip Life
- Remove Excess Solder

Cheap synthetic sponges, like common household sponges, are not recommended for tip cleaning. They contain colorings, plasticizers, stiffeners, and other contaminants which will shorten tip life.

CS-17 PLATO CUT-TO-FIT SHEET

For difficult to find sponge sizes or special applications, Plato offers full sheets of sponge material that can be trimmed to exact size.

CS-17—1 sheet, 216mm x 432mm x 25mm thick

CS-17/625—Thinner Economy Sponge (1 sheet, 216mm x 432mm x 16mm thick)



(SCISSORS NOT INCLUDED)

CS-43 • CS-44/44M HAKKO COMPATIBLE REPLACEMENT SPONGES

CS-43—10 sponges/pack, 45mm x 102mm x 25mm thick
Fits Hakko 926-029B



CS-44—10 sponges/pack, 69mm x 69mm x 25mm thick
Fits Hakko 609-0229, A-1042

CS-44M—10 sponges/pack, 69mm x 69mm x 25mm thick
Fits Hakko 609-0229, A-1042



C-1 • CS-14/14M • CS-33 • CS-44/44M WELLER COMPATIBLE REPLACEMENT SPONGES



C-1—10 sponges/pack, 38mm x 54mm x 25mm thick
Fits Weller SP-60

CS-14—10 sponges/pack, 55mm x 70mm x 25mm thick
Fits Weller 52241999



CS-14M—10 sponges/pack, 55mm x 70mm x 25mm thick
Fits Weller 52241999

CS-33—10 sponges/pack, 70mm x 114mm x 25mm thick
Fits Weller EC-205



CS-44—10 sponges/pack, 69mm x 69mm x 25mm thick
Fits Weller TC-205

CS-44M—10 sponges/pack, 69mm x 69mm x 25mm thick
Fits Weller TC-205

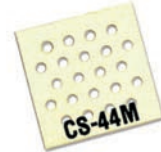

CS-47 METCAL & UNGAR COMPATIBLE REPLACEMENT SPONGES



CS-47—10 sponges/pack, 53mm x 81mm x 25mm thick
Fits Metcal STSS-YS3 and Ungar 455, UTC234

CS-36 HEXACON COMPATIBLE REPLACEMENT SPONGES

CS-9/625—10 sponges/pack, 89mm x 114mm x 16mm thick
Fits Hexacon 8101, 8101C, 8121, 8121C



CS-36—10 sponges/pack, 57mm x 89mm x 25mm thick
Fits Hexacon 8141, 8141C

TT-95 TIP TINNER/TIP CLEANER



Plato's Tip Cleaner provides fast, efficient cleaning and re-tinning of highly oxidized soldering iron tips. This thermally-stable compound is lead-free, environmentally safe, and in an ESD-safe container. Tip Cleaner brings oxidized tips back to life, which improves soldering speed. Roll a hot soldering tip in the Tip Cleaner for a few seconds until the bright tinning surrounds the end of the tip.

- Extends tip life
- Lead-free
- Easy to use

TT-95 1 – 20g container, 10 per case



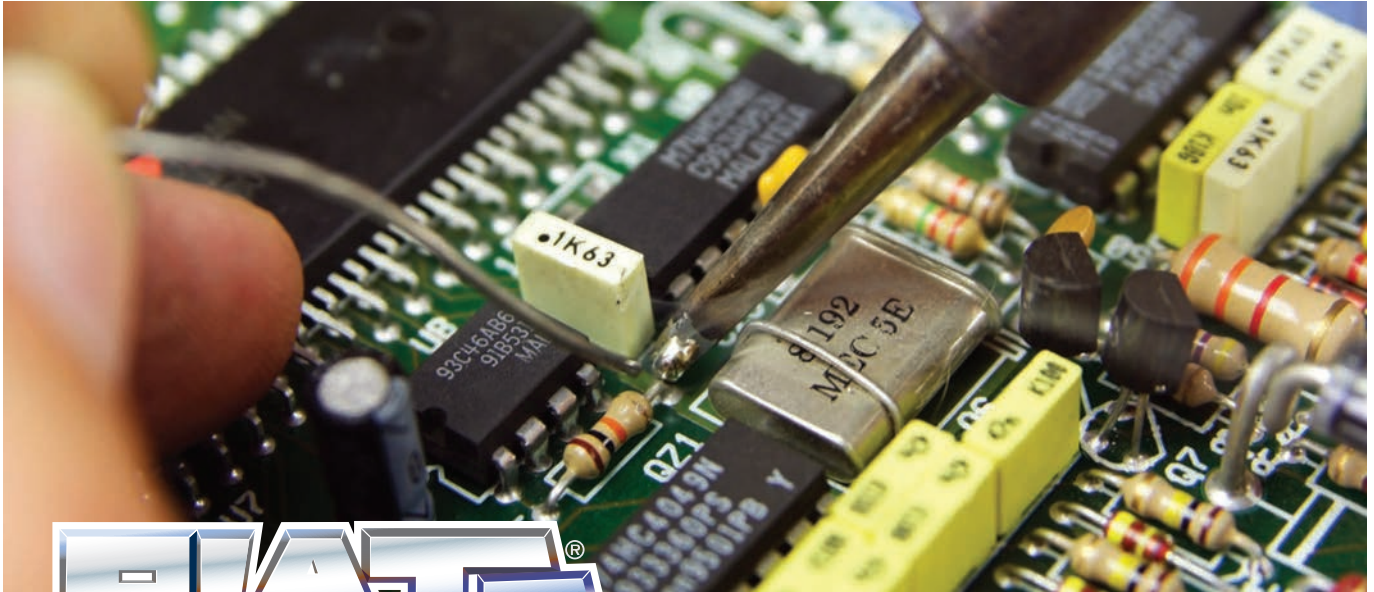

PLATO®

REPLACEMENT SOLDERING & DESOLDERING TIPS

Tip drawings are actual size

Hakko®	Plato®	() = mm
900M-T-1C	HS-5701	3/64" (1.2)
900M-T-2C	HS-5702	5/64" (2.0)
900M-T-3C	HS-5703	1/8" (3.0)
900M-T-4C	HS-5875	5/32" (4.0)
900M-T-0.8D	HS-2863	1/32" (0.8)
900M-T-1.2D	HS-2796	3/64" (1.2)
900M-T-1.2LD	HS-6030	3/64" (1.2)
900M-T-1.6D	HS-2751	1/16" (1.6)
900M-T-2.4D	HS-2752	3/32" (2.4)
900M-T-3.2D	HS-2753	1/8" (3.2)
900M-T-0.2RB	HS-4791	0.016" (0.4)

Tip drawings are actual size

Hakko®	Plato®	() = mm
900M-T-H	HS-0925	30° 1/16" (1.6)
900M-T-B	HS-4785	.040" (1.0) .250" TIN LENGTH
	HS-8179	.040" (1.0) .300" TIN LENGTH
900M-T-LB	HS-4786	1/64" (0.4)
900M-T-1	HS-4787	1/64" (0.8)
900M-T-K	HS-0927	3/16" (4.7) 1/4" (6.3)
900M-T-S1	HS-2796	3/64" (1.2)
900M-T-S3	HS-1665	13/64" (5.2)
900M-T-S4	HS-8175	.008" (0.2)
900M-T-S5	HS-8157	1/64" (0.4)
SMD Flow Tip	HS-0530	.128" (3.3) .118" (3.0)
SMD Flow Tip	HS-0531	.195" (5.0) .135" (3.4)

Tip drawings are actual size

Hakko®	Plato®	() = mm
900L-T-5C	HS-5876	
900L-T-K	HS-0922	 SMD Tip to solder SOIC and PLCC D1: .010\" (2) D2: .080\" (2.0) Angle: 285° (7.2)

Hakko®	Plato®	() = mm
900L-T-S1	HS-1666	

Tip drawings are actual size.

Hakko®	Plato®	D1 (mm)	D2 (mm)
A-1002	HK-0878	.030" (0.8)	.070" (1.8)
A-1003	HK-0879	.040" (1.0)	.080" (2.0)
A-1004	HK-0880	.030" (0.8)	.090" (2.3)
A-1005	HK-0881	.040" (1.0)	.100" (2.5)
A-1006	HK-0882	.050" (1.3)	.120" (3.0)
A-1007	HK-0883	.060" (1.5)	.120" (3.0)

- Premium quality for long life
- Iron plated outside and stainless steel tube insert prevents solder path erosion
- All dimensions are shown before tinning and are subject to manufacturing tolerances

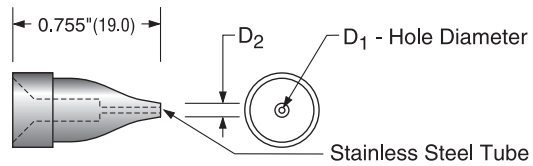

LONG LIFE LEAD-FREE TIPS

- Longer Life
- Designed for lead-free soldering
- Look for tips with an LF added to the end of the part number



Weller®	Plato®	() = mm
—	MS-4140	
LT1	MS-4120	
LT1L	MS-4110	
LT1LX	MS-4101	
LT1S	MS-4100	
LT4W	MS-5160	

Tip drawings are actual size

Weller®	Plato®	() = mm
LT4X	MS-3125	
LTA LTA LF NEW!	MS-3200 MS-3200LF	
LTB LTB LF NEW!	MS-3300 MS-3300LF	
LTC LTC LF NEW!	MS-3400 MS-3400LF	
LTD LTD LF NEW!	MS-3600 MS-3600LF	

Be sure to add temperature indicating number to Plato® part number when ordering Plato® C-Tips.

Choose the desired temperature and add it to the end of the Plato part number* (Example C-3039-7)

Desired Temperature	Suffix to Add to Plato Part Number
700°F / 370°C	-7
800°F / 425°C	-8
900°F / 480°C	-9

Tip drawings are actual size

Weller®	Plato®	() = mm
PTA	C-3039	1/16" (1.6)
PTB	C-3040	3/32" (2.4)
PTC	C-3036	1/8" (3.2)
PTD	C-1016	3/16" (4.8)
PTF	C-593	1/32" (0.8)
PTH	C-3100	1/32" (0.8)

Tip drawings are actual size

Weller®	Plato®	() = mm
PTK	C-3043	3/64" (1.2)
PTL	C-3044	5/64" (2.0)
PTM	C-3102	1/8" (3.2)
PTO	C-4223	1/32" (0.8)
PTP	C-462	1/32" (0.8)
PTS	C-494	1/64" (0.4)
PTBB	C-5143	3/32" (2.4)
PTCC	C-5141	1/8" (3.2)

*Indicated temperature ranges are nominal and will vary according to style of tip, condition of iron, manner of use, and other variables. All dimensions are shown before tinning and are subject to manufacturing tolerances.

Tip drawings are actual size.

Weller®	Plato®	() = mm
LTGW LTGW LF NEW!	MS-0100 MS-0100LF	.122" (3.1) / .084" (2.1)
LTH	MS-3110	.031" (0.8)
LTHX	MS-3101	.024" (0.6) / .016" (0.4)
LTK	MS-3150	.050" (1.3) / .020" (0.5)
LTL	MS-3250	.079" (2.0) / .039" (1.0)
LTM	MS-3450	.125" (3.2) / .047" (1.2)

Tip drawings are actual size.

Weller®	Plato®	() = mm
LTS	MS-4130	.018" (0.5)
LTO LF NEW!	MS-4200LF	0.039" (0.9)
LTBB LF NEW!	MS-5300LF	0.094" (2.4)
LTCC LF NEW!	MS-5400LF	0.125" (3.2)
LTKN LF NEW!	MS-0201LF	0.162" (4.0) / 0.228" (5.7) / 0.002" (0.05) / 0.06" (1.5)

Tip drawings not actual size

Weller®	Plato®	() = mm
ETA	EW-303	1/16" (1.6)
ETB	EW-305	3/32" (2.4)
ETC	EW-307	1/8" (3.2)
ETD	EW-103	3/16" (4.8)
ETE	EW-105	7/32" (5.6)
ETGW	EW-0574	.195" (5.0) SMD Flow Tip .135" (3.4)
ETH	EW-301	1/32" (0.8)
ETJ	EW-302	1/32" (0.8)
ETK	EW-304	3/64" (1.2)
ETL	EW-306	5/64" (2.0)
ETM	EW-308	1/8" (3.2)

Weller®	Plato®	() = mm
ETO	EW-404	1/32" (0.8)
ETP	EW-403	1/32" (0.8)
ETR	EW-101	1/16" (1.6)
ETS	EW-402	.012" (0.3)
ETT	EW-401	1/64" (0.4)
ETV	EW-511	.025" (0.6)
	EW-0602	.020" (0.5) SMD .031" (0.8)
ETAA	EW-513	1/32" (0.8)
ETBB	EW-515	1/16" (1.6)
ETCC	EW-517	3/32" (2.4)
		1/8" (3.2)

PACE®

Desoldering Tips to Replace Pace Endura Tips
 Desoldering Irons SX90, SX-80 and SX-70 with Paper Chamber 3/16" Diameter

Pace®	Plato®	ID (mm)	OD (mm)
1121-0625	30-0301	.03" (0.8)	.08" (2.0)
1121-0624	30-0401	.04" (1.0)	.09" (2.3)
1121-0626	30-0601	.06" (1.5)	.12" (3.1)
1121-0627	30-0901	.09" (2.3)	.20" (5.1)
1121-0628	30-1003	.03" (0.8)	.09" (2.3)
1121-0629	30-1004	.04" (1.0)	.10" (2.5)
1121-0630	30-1006	.06" (1.5)	.12" (3.1)
1121-0681	30-1020	.02" (0.5)	.07" (1.8)
1121-0682	30-1030	.03" (0.8)	.08" (2.0)
1121-0683	30-1040	.04" (1.0)	.09" (2.3)
1121-0631	30-1060	.06" (1.5)	.19" (4.8)
1121-0680	30-1200	.02" (0.5)	.07" (1.8)
1121-0678	30-1300	.03" (0.8)	.08" (2.0)
1121-0679	30-1400	.04" (1.0)	.09" (2.3)
1121-0690	30-1600	.06" (1.5)	.11" (2.8)



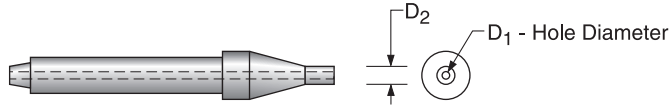

Pace®	Plato®	D1 (mm)	D2 (mm)
1121-0342	30-0400	.040" (1.0)	.085" (2.2)
1121-0463	30-040	.040" (1.0)	.085" (2.2)
---	30-050	.050" (1.3)	.095" (2.4)

Pace®	Plato®	D1 (mm)	D2 (mm)
1121-0368	30-0600	.060" (1.5)	.115" (2.9)
1121-0464	30-060	.060" (1.5)	.115" (2.9)
1121-0507	30-0900	.090" (2.3)	.190" (4.8)

Desoldering Irons • Pace® • Air-Vac® • A.P.E.

AIR-VAC®

A.P.E.®

PACE®

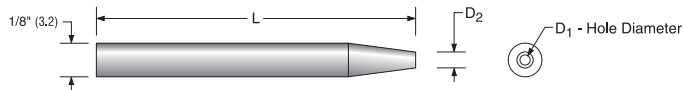

Pace®	Plato®	L (mm)	D1 (mm)	D2 (mm)
Plato® Tips to fit Pace® SX-20, SX-25, SX-25V SODR-X-TRACTORS®				
1121-0480	20-0114	1.00" (25.4)	.030" (0.8)	.060" (1.5)
---	20-0815	1.00" (25.4)	.036" (0.9)	.065" (1.7)
1121-0479	20-0110	1.00" (25.4)	.040" (1.0)	.080" (2.0)
1121-0216	20-0113	1.00" (25.4)	.050" (1.3)	.090" (2.3)
1121-0217	20-0111	1.00" (25.4)	.060" (1.5)	.100" (2.5)

Pace®	Plato®	L (mm)	D1 (mm)	D2 (mm)
Plato® Tips to fit Pace® SX-40A, SX-55A, SX-65A, SX-70 SODR-X-TRACTORS® with Plato Adapter 33-0001				
1121-0485	20-025	1.75" (44.5)	.030" (0.8)	.080" (2.0)
1121-0486	20-040	1.75" (44.5)	.040" (1.0)	.080" (2.0)
1121-0255	20-060	1.75" (44.5)	.060" (1.5)	.100" (2.5)

Soldering Stations • SMT 60 • Digital 2000 with Micro Tool
Twin 80 A with Micro Tool

ERSA®

Tip drawings are actual size

Ersa®	Plato®	() = mm
212BD	ER-4007	0.004" (0.1)

Ersa®	Plato®	() = mm
212SD	ER-4001	0.06" (1.6)

Soldering Stations • 203 • 203H • 204 • 204H

QUICK

Tip drawings are actual size

Quick	Plato®	() = mm
200-1C	NEW! DN-1C	1 mm
200-2.4D	NEW! DN-2.4D	2.4 mm, 0.028" (0.7)
200-3C	NEW! DN-3C	3.0 mm

Quick	Plato®	() = mm
200-B	NEW! DN-B	1 mm
200-K	NEW! DN-K	5 mm, 6.8 mm
200-SK	NEW! DN-SK	3 mm, 3.8 mm



TIP CROSS REFERENCE

Ersa®	Plato®	Pg.
212BD	ER-4007	11
212SD	ER-4001	11

Hakko®	Plato®	Pg.
900L-T-5C	HS-5876	8
900L-T-K	HS-0922	8
900L-T-S1	HS-1666	8
900M-T-0.2RB	HS-4791	7
900M-T-0.8D	HS-2863	7
900M-T-1.2D	HS-2796	7
900M-T-1.2LD	HS-6030	7
900M-T-1.6D	HS-2751	7
900M-T-1.8H	HS-0926	7
900M-T-1C	HS-5701	7
900M-T-2.4D	HS-2752	7
900M-T-2C	HS-5702	7
900M-T-3.2D	HS-2753	7
900M-T-3C	HS-5703	7
900M-T-4C	HS-5875	7
900M-T-B	HS-4785	7
900M-T-H	HS-0925	7
900M-T-1	HS-4787	7
900M-T-K	HS-0927	7
900M-T-LB	HS-4786	7
900M-T-S1	HS-2796	7
900M-T-S3	HS-1665	7
900M-T-S4	HS-8175	7
900M-T-S5	HS-8157	7
A-1002	HK-0878	8
A-1003	HK-0879	8
A-1004	HK-0880	8
A-1005	HK-0881	8
A-1006	HK-0882	8
A-1007	HK-0883	8
SMD Flow Tip	HS-0530	8
SMD Flow Tip	HS-0531	8

Pace®	Plato®	Pg.
1121-0216	20-0113	11
1121-0217	20-0111	11
1121-0255	20-060	11
1121-0342	30-0400	11
1121-0368	30-0600	11
1121-0463	30-040	11
1121-0464	30-060	11
1121-0479	20-0110	11

1121-0480	20-0114	11
1121-0485	20-025	11
1121-0486	20-040	11
1121-0507	30-0900	11
1121-0624	30-0401	10
1121-0625	30-0301	10
1121-0626	30-0601	10
1121-0627	30-0901	10
1121-0628	30-1003	10
1121-0629	30-1004	10
1121-0630	30-1006	10
1121-0631	30-1060	10
1121-0678	30-1300	10
1121-0679	30-1400	10
1121-0680	30-1200	10
1121-0681	30-1020	10
1121-0682	30-1030	10
1121-0683	30-1040	10
1121-0690	30-1600	10

Quick	Plato®	Pg.
200-1C	DN-1C	11
200-2.4D	DN-2.4D	11
200-3C	DN-3C	11
200-B	DN-B	11
200-K	DN-K	11
200-SK	DN-SK	11

Weller®	Plato®	Pg.
ETA	EW-303	10
ETAA	EW-513	10
ETB	EW-305	10
ETBB	EW-515	10
ETC	EW-307	10
ETCC	EW-517	10
ETD	EW-103	10
ETE	EW-105	10
ETGW	EW-0574	10
ETH	EW-301	10
ETJ	EW-302	10
ETK	EW-304	10
ETL	EW-306	10
ETM	EW-308	10
ETO	EW-404	10
ETP	EW-403	10
ETR	EW-101	10
ETS	EW-402	10

ETT	EW-401	10
ETV	EW-511	10
LT1	MS-4120	8
LT1L	MS-4110	8
LT1LX	MS-4101	8
LT1S	MS-4100	8
LT4W	MS-5160	8
LT4X	MS-3125	8
LTA	MS-3200	8
LTA LF	MS-3200LF	8
LTB	MS-3300	8
LTB LF	MS-3300LF	8
LTBB LF	MS-5300LF	8
LTC	MS-3400	8
LTC LF	MS-3400LF	8
LTCC LF	MS-5400LF	8
LTD	MS-3600	8
LTD LF	MS-3600LF	8
LTGW	MS-0100	9
LTGW LF	MS-0100LF	9
LTH	MS-3110	9
LTHX	MS-3101	9
LTK	MS-3150	9
LTKN LF	MS-0201LF	9
LTL	MS-3250	9
LTM	MS-3450	9
LTO LF	MS-4200LF	9
LTS	MS-4130	9
LTBB LF	MS-5300LF	9
LTCC LF	MS-5400LF	9
LTKN LF	MS-0201LF	9
PTA*	C-3039	9
PTB*	C-3040	9
PTBB*	C-5143	9
PTC*	C-3036	9
PTCC*	C-5141	9
PTD*	C-1016	9
PTF*	C-593	9
PTH*	C-3100	9
PTK*	C-3043	9
PTL*	C-3044	9
PTM*	C-3102	9
PTO*	C-4223	9
PTP*	C-462	9
PTS*	C-494	9

*A temperature designating number is used by both Plato and Weller, e.g. Weller PTA7 is equivalent to Plato C-3039-7



8125 Cobb Center Drive ■ Kennesaw, GA 30152-4386
 Tel: 770-424-4888 ■ Toll Free: 1-800-645-5244
 Fax: 770-423-0748 ■ Toll Free Fax: 1-800-243-6003
 www.chemtronics.com



platoproducts.com





Компания «ЭлектроПласт» предлагает заключение долгосрочных отношений при поставках импортных электронных компонентов на взаимовыгодных условиях!

Наши преимущества:

- Оперативные поставки широкого спектра электронных компонентов отечественного и импортного производства напрямую от производителей и с крупнейших мировых складов;
- Поставка более 17-ти миллионов наименований электронных компонентов;
- Поставка сложных, дефицитных, либо снятых с производства позиций;
- Оперативные сроки поставки под заказ (от 5 рабочих дней);
- Экспресс доставка в любую точку России;
- Техническая поддержка проекта, помощь в подборе аналогов, поставка прототипов;
- Система менеджмента качества сертифицирована по Международному стандарту ISO 9001;
- Лицензия ФСБ на осуществление работ с использованием сведений, составляющих государственную тайну;
- Поставка специализированных компонентов (Xilinx, Altera, Analog Devices, Intersil, Interpoint, Microsemi, Aeroflex, Peregrine, Syfer, Eurofarad, Texas Instrument, Miteq, Cobham, E2V, MA-COM, Hittite, Mini-Circuits, General Dynamics и др.);

Помимо этого, одним из направлений компании «ЭлектроПласт» является направление «Источники питания». Мы предлагаем Вам помощь Конструкторского отдела:

- Подбор оптимального решения, техническое обоснование при выборе компонента;
- Подбор аналогов;
- Консультации по применению компонента;
- Поставка образцов и прототипов;
- Техническая поддержка проекта;
- Защита от снятия компонента с производства.



Как с нами связаться

Телефон: 8 (812) 309 58 32 (многоканальный)

Факс: 8 (812) 320-02-42

Электронная почта: org@eplast1.ru

Адрес: 198099, г. Санкт-Петербург, ул. Калинина, дом 2, корпус 4, литера А.