

# NTR1P02L, NVTR01P02L

## Power MOSFET

**-20 V, -1.3 A, P-Channel  
SOT-23 Package**

These miniature surface mount MOSFETs low  $R_{DS(on)}$  assure minimal power loss and conserve energy, making these devices ideal for use in space sensitive power management circuitry. Typical applications are DC-DC converters and power management in portable and battery-powered products such as computers, printers, PCMCIA cards, cellular and cordless telephones.

### Features

- Low  $R_{DS(on)}$  Provides Higher Efficiency and Extends Battery Life
- Miniature SOT-23 Surface Mount Package Saves Board Space
- NVTR Prefix for Automotive and Other Applications Requiring Unique Site and Control Change Requirements; AEC-Q101 Qualified and PPAP Capable
- Pb-Free and Halide-Free Packages are Available

### MAXIMUM RATINGS ( $T_J = 25^\circ\text{C}$ unless otherwise noted)

Rating	Symbol	Value	Unit
Drain-to-Source Voltage	$V_{DSS}$	-20	V
Gate-to-Source Voltage - Continuous	$V_{GS}$	$\pm 12$	V
Drain Current - Continuous @ $T_A = 25^\circ\text{C}$ - Pulsed Drain Current ( $t_p \leq 10 \mu\text{s}$ )	$I_D$ $I_{DM}$	-1.3 -4.0	A A
Total Power Dissipation @ $T_A = 25^\circ\text{C}$	$P_D$	400	mW
Operating and Storage Temperature Range	$T_J, T_{stg}$	-55 to 150	$^\circ\text{C}$
Thermal Resistance - Junction-to-Ambient	$R_{\theta JA}$	300	$^\circ\text{C/W}$
Maximum Lead Temperature for Soldering Purposes, (1/8" from case for 10 s)	$T_L$	260	$^\circ\text{C}$

Stresses exceeding Maximum Ratings may damage the device. Maximum Ratings are stress ratings only. Functional operation above the Recommended Operating Conditions is not implied. Extended exposure to stresses above the Recommended Operating Conditions may affect device reliability.



**ON Semiconductor®**

<http://onsemi.com>

$V_{(BR)DSS}$	$R_{DS(on)}$ Max	$I_D$ Max
-20 V	220 m $\Omega$ @ -4.5 V	-1.3 A

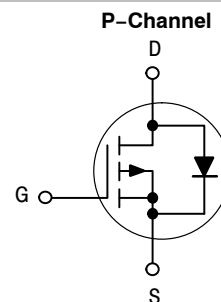

### MARKING DIAGRAM & PIN ASSIGNMENT

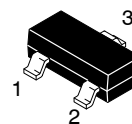

**SOT-23  
CASE 318  
STYLE 21**

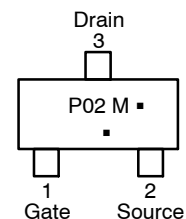

P02 = Specific Device Code  
M = Date Code\*  
▪ = Pb-Free Package

(Note: Microdot may be in either location)  
\*Date Code orientation may vary depending upon manufacturing location.

### ORDERING INFORMATION

Device	Package	Shipping†
NTR1P02LT1G	SOT-23 (Pb-Free)	3000 Tape & Reel
NTR1P02LT3G	SOT-23 (Pb-Free)	10,000 Tape & Reel
NVTR01P02LT1G	SOT-23 (Pb-Free)	3000 Tape & Reel

†For information on tape and reel specifications, including part orientation and tape sizes, please refer to our Tape and Reel Packaging Specifications Brochure, BRD8011/D.

# NTR1P02L, NVTR01P02L

## ELECTRICAL CHARACTERISTICS ( $T_A = 25^\circ\text{C}$ unless otherwise noted)

Parameter	Test Condition	Symbol	Min	Typ	Max	Unit
-----------	----------------	--------	-----	-----	-----	------

### OFF CHARACTERISTICS

Drain-to-Source Breakdown Voltage	$(V_{GS} = 0\text{ V}, I_D = -10\ \mu\text{A})$	$V_{(BR)DSS}$	-20			V
Zero Gate Voltage Drain Current	$(V_{DS} = -16\text{ V}, V_{GS} = 0\text{ V})$ $(V_{DS} = -16\text{ V}, V_{GS} = 0\text{ V}, T_J = 125^\circ\text{C})$	$I_{DSS}$			-1.0 -10	$\mu\text{A}$
Gate-Body Leakage Current	$(V_{GS} = \pm 12\text{ V}, V_{DS} = 0\text{ V})$	$I_{GSS}$			$\pm 100$	nA

### ON CHARACTERISTICS (Note 1)

Gate Threshold Voltage	$(V_{DS} = V_{GS}, I_D = -250\ \mu\text{A})$	$V_{GS(th)}$	-0.7	-1.0	-1.25	V
Static Drain-to-Source On-Resistance	$(V_{GS} = -4.5\text{ V}, I_D = -0.75\text{ A})$ $(V_{GS} = -2.5\text{ V}, I_D = -0.5\text{ A})$	$r_{DS(on)}$		0.140 0.200	0.22 0.35	$\Omega$

### DYNAMIC CHARACTERISTICS

Input Capacitance	$(V_{DS} = -5.0\text{ V})$	$C_{iss}$		225		pF
Output Capacitance	$(V_{DS} = -5.0\text{ V})$	$C_{oss}$		130		
Transfer Capacitance	$(V_{DS} = -5.0\text{ V})$	$C_{rss}$		55		

### SWITCHING CHARACTERISTICS (Note 2)

Turn-On Delay Time	$(V_{GS} = -4.5\text{ V}, V_{DD} = -5.0\text{ V}, I_D = -1.0\text{ A}, R_L = 5.0\ \Omega, R_G = 6.0\ \Omega)$	$t_{d(on)}$		7.0		ns
Rise Time		$t_r$		15		
Turn-Off Delay Time		$t_{d(off)}$		18		
Fall Time		$t_f$		9		
Total Gate Charge	$(V_{DS} = -16\text{ V}, I_D = -1.5\text{ A}, V_{GS} = -4.5\text{ V})$	$Q_T$		3.1		nC

### SOURCE-DRAIN DIODE CHARACTERISTICS

Continuous Current		$I_S$			-0.6	A
Pulsed Current		$I_{SM}$			-0.75	
Forward Voltage (Note 2)	$(V_{GS} = 0\text{ V}, I_S = -0.6\text{ A})$	$V_{SD}$			-1.0	V
Reverse Recovery Time	$(I_S = -1.0\text{ A}, V_{GS} = 0\text{ V}, di_S/dt = 100\text{ A}/\mu\text{s})$	$t_{rr}$		16		ns
		$t_a$		11		
		$t_b$		5.5		
Reverse Recovery Stored Charge		$Q_{RR}$		8.5		nC

1. Pulse Test: Pulse Width  $\leq 300\ \mu\text{s}$ , Duty Cycle  $\leq 2\%$ .
2. Switching characteristics are independent of operating junction temperature.

# NTR1P02L, NVTR01P02L

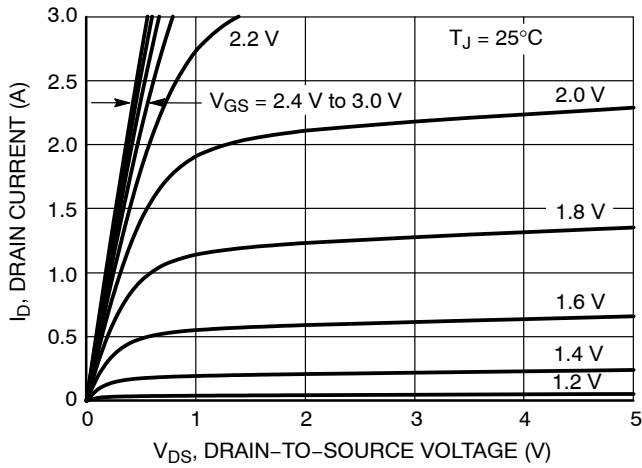

Figure 1. On-Region Characteristics

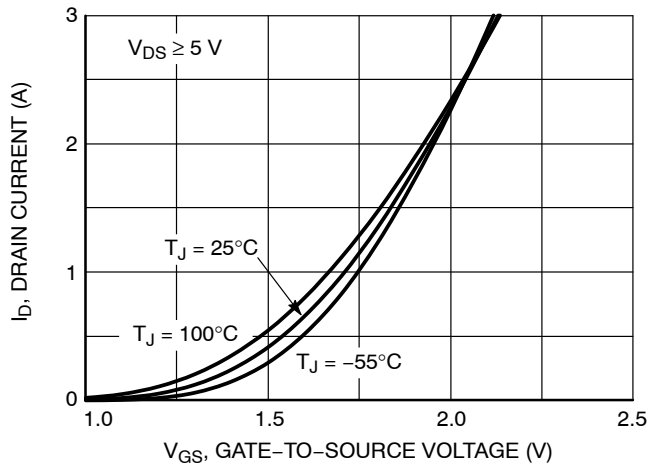

Figure 2. Transfer Characteristics

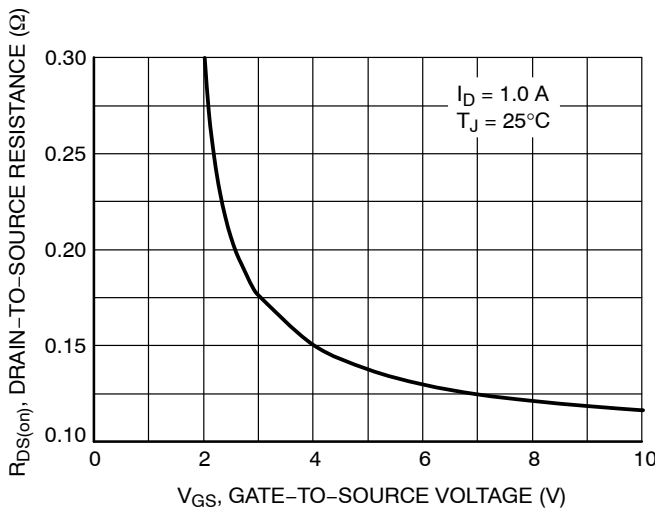

Figure 3. On-Resistance vs. Gate-to-Source Voltage

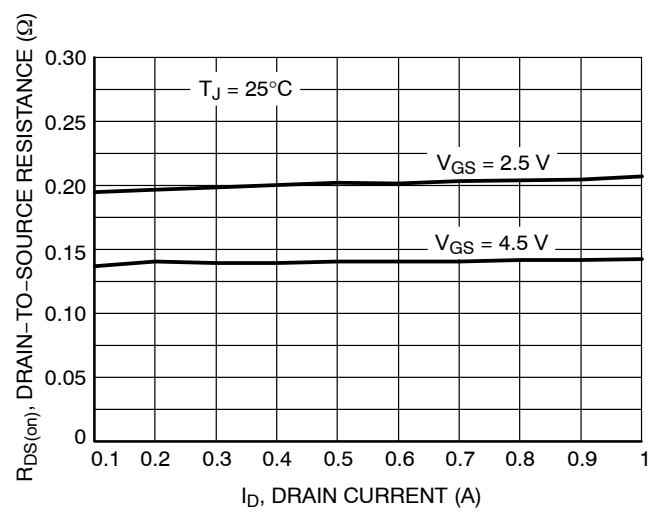

Figure 4. On-Resistance vs. Drain Current and Gate Voltage

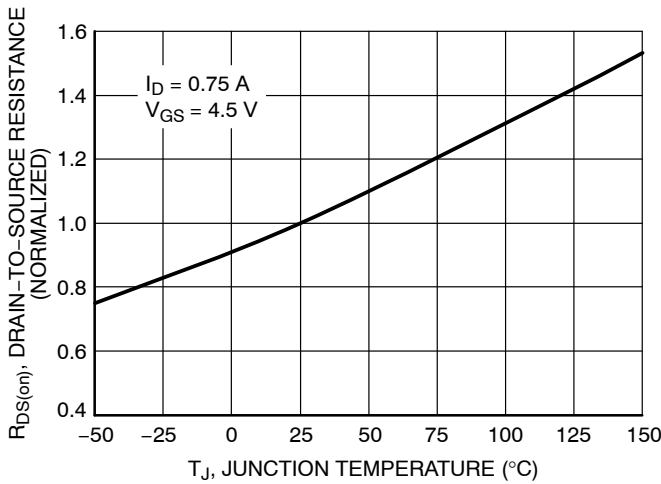

Figure 5. On-Resistance Variation with Temperature

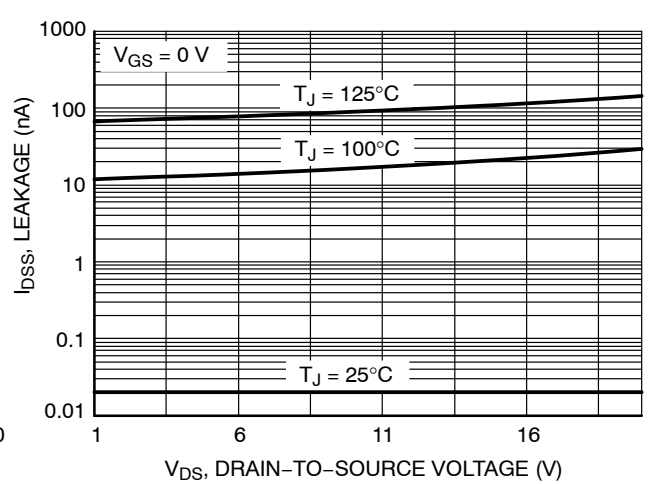

Figure 6. Drain-to-Source Leakage Current vs. Voltage

# NTR1P02L, NVTR01P02L

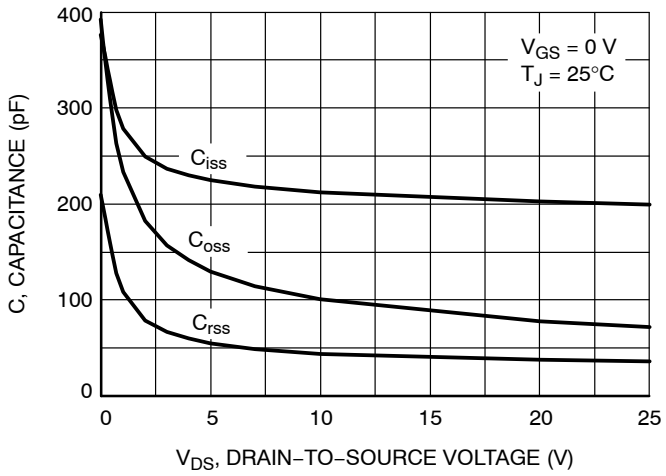

Figure 7. Capacitance Variation

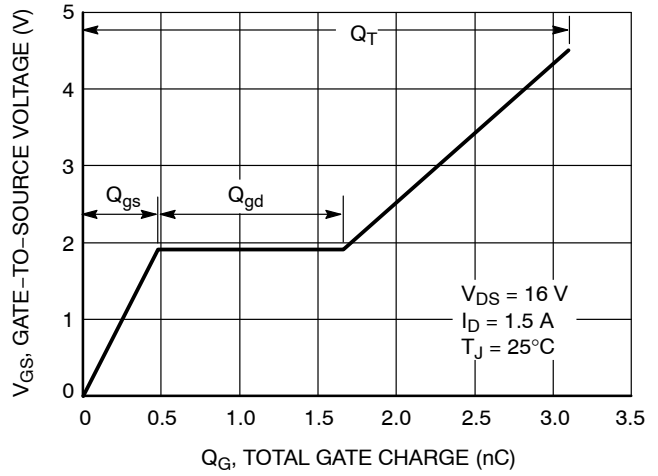

Figure 8. Gate-to-Source and Drain-to-Source Voltage vs. Total Charge

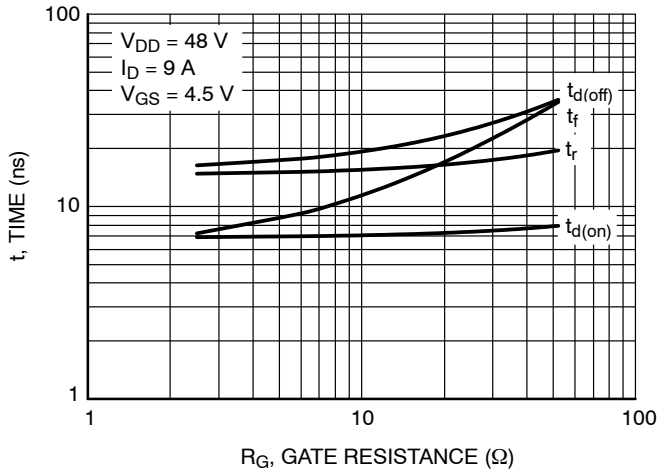

Figure 9. Resistive Switching Time Variation vs. Gate Resistance

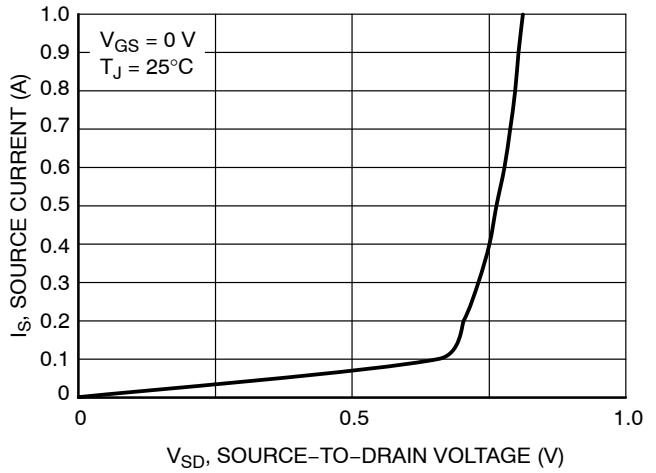

Figure 10. Diode Forward Voltage vs. Current

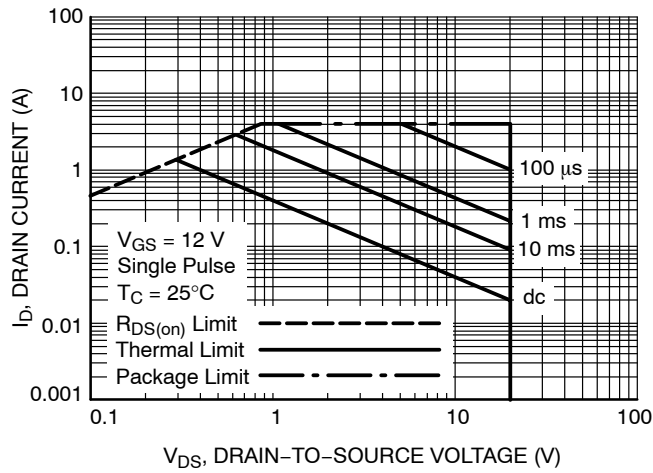
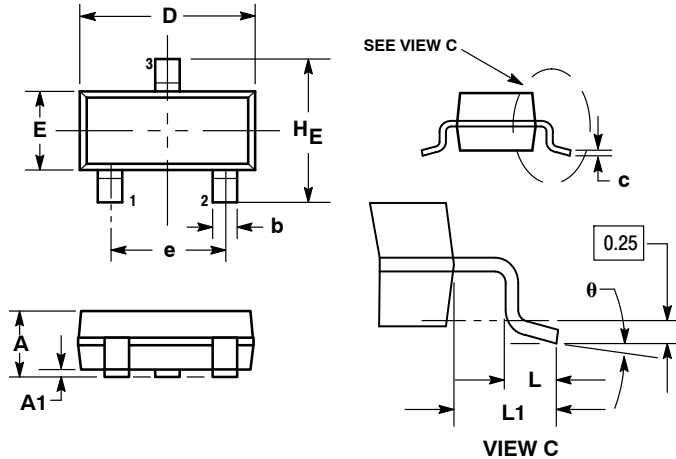

Figure 11. Maximum Rated Forward Biased Safe Operating Area

# NTR1P02L, NVTR01P02L

## PACKAGE DIMENSIONS

SOT-23 (TO-236)  
CASE 318-08  
ISSUE AP



NOTES:

1. DIMENSIONING AND TOLERANCING PER ANSI Y14.5M, 1982.
2. CONTROLLING DIMENSION: INCH.
3. MAXIMUM LEAD THICKNESS INCLUDES LEAD FINISH THICKNESS. MINIMUM LEAD THICKNESS IS THE MINIMUM THICKNESS OF BASE MATERIAL.
4. DIMENSIONS D AND E DO NOT INCLUDE MOLD FLASH, PROTRUSIONS, OR GATE BURRS.

DIM	MILLIMETERS			INCHES		
	MIN	NOM	MAX	MIN	NOM	MAX
A	0.89	1.00	1.11	0.035	0.040	0.044
A1	0.01	0.06	0.10	0.001	0.002	0.004
b	0.37	0.44	0.50	0.015	0.018	0.020
c	0.09	0.13	0.18	0.003	0.005	0.007
D	2.80	2.90	3.04	0.110	0.114	0.120
E	1.20	1.30	1.40	0.047	0.051	0.055
e	1.78	1.90	2.04	0.070	0.075	0.081
L	0.10	0.20	0.30	0.004	0.008	0.012
L1	0.35	0.54	0.69	0.014	0.021	0.029
HE	2.10	2.40	2.64	0.083	0.094	0.104
θ	0°	---	10°	0°	---	10°

STYLE 21:  
PIN 1. GATE  
2. SOURCE  
3. DRAIN

### SOLDERING FOOTPRINT\*

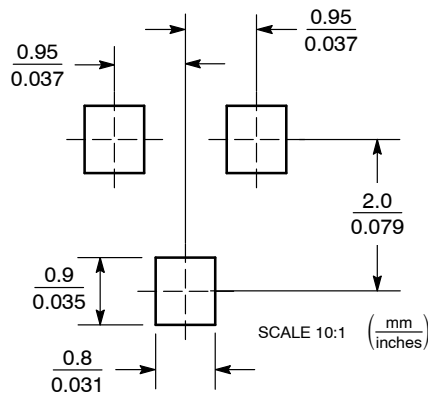

\*For additional information on our Pb-Free strategy and soldering details, please download the ON Semiconductor Soldering and Mounting Techniques Reference Manual, SOLDERRM/D.

ON Semiconductor and are registered trademarks of Semiconductor Components Industries, LLC (SCILLC). SCILLC owns the rights to a number of patents, trademarks, copyrights, trade secrets, and other intellectual property. A listing of SCILLC's product/patent coverage may be accessed at [www.onsemi.com/site/pdf/Patent-Marking.pdf](http://www.onsemi.com/site/pdf/Patent-Marking.pdf). SCILLC reserves the right to make changes without further notice to any products herein. SCILLC makes no warranty, representation or guarantee regarding the suitability of its products for any particular purpose, nor does SCILLC assume any liability arising out of the application or use of any product or circuit, and specifically disclaims any and all liability, including without limitation special, consequential or incidental damages. "Typical" parameters which may be provided in SCILLC data sheets and/or specifications can and do vary in different applications and actual performance may vary over time. All operating parameters, including "Typicals" must be validated for each customer application by customer's technical experts. SCILLC does not convey any license under its patent rights nor the rights of others. SCILLC products are not designed, intended, or authorized for use as components in systems intended for surgical implant into the body, or other applications intended to support or sustain life, or for any other application in which the failure of the SCILLC product could create a situation where personal injury or death may occur. Should Buyer purchase or use SCILLC products for any such unintended or unauthorized application, Buyer shall indemnify and hold SCILLC and its officers, employees, subsidiaries, affiliates, and distributors harmless against all claims, costs, damages, and expenses, and reasonable attorney fees arising out of, directly or indirectly, any claim of personal injury or death associated with such unintended or unauthorized use, even if such claim alleges that SCILLC was negligent regarding the design or manufacture of the part. SCILLC is an Equal Opportunity/Affirmative Action Employer. This literature is subject to all applicable copyright laws and is not for resale in any manner.

### PUBLICATION ORDERING INFORMATION

LITERATURE FULFILLMENT:  
Literature Distribution Center for ON Semiconductor  
P.O. Box 5163, Denver, Colorado 80217 USA  
Phone: 303-675-2175 or 800-344-3860 Toll Free USA/Canada  
Fax: 303-675-2176 or 800-344-3867 Toll Free USA/Canada  
Email: [orderlit@onsemi.com](mailto:orderlit@onsemi.com)

N. American Technical Support: 800-282-9855 Toll Free  
USA/Canada  
Europe, Middle East and Africa Technical Support:  
Phone: 421 33 790 2910  
Japan Customer Focus Center  
Phone: 81-3-5817-1050

ON Semiconductor Website: [www.onsemi.com](http://www.onsemi.com)  
Order Literature: <http://www.onsemi.com/orderlit>  
For additional information, please contact your local Sales Representative



Компания «ЭлектроПласт» предлагает заключение долгосрочных отношений при поставках импортных электронных компонентов на взаимовыгодных условиях!

Наши преимущества:

- Оперативные поставки широкого спектра электронных компонентов отечественного и импортного производства напрямую от производителей и с крупнейших мировых складов;
- Поставка более 17-ти миллионов наименований электронных компонентов;
- Поставка сложных, дефицитных, либо снятых с производства позиций;
- Оперативные сроки поставки под заказ (от 5 рабочих дней);
- Экспресс доставка в любую точку России;
- Техническая поддержка проекта, помощь в подборе аналогов, поставка прототипов;
- Система менеджмента качества сертифицирована по Международному стандарту ISO 9001;
- Лицензия ФСБ на осуществление работ с использованием сведений, составляющих государственную тайну;
- Поставка специализированных компонентов (Xilinx, Altera, Analog Devices, Intersil, Interpoint, Microsemi, Aeroflex, Peregrine, Syfer, Eurofarad, Texas Instrument, Miteq, Cobham, E2V, MA-COM, Hittite, Mini-Circuits, General Dynamics и др.);

Помимо этого, одним из направлений компании «ЭлектроПласт» является направление «Источники питания». Мы предлагаем Вам помощь Конструкторского отдела:

- Подбор оптимального решения, техническое обоснование при выборе компонента;
- Подбор аналогов;
- Консультации по применению компонента;
- Поставка образцов и прототипов;
- Техническая поддержка проекта;
- Защита от снятия компонента с производства.



#### Как с нами связаться

**Телефон:** 8 (812) 309 58 32 (многоканальный)

**Факс:** 8 (812) 320-02-42

**Электронная почта:** [org@eplast1.ru](mailto:org@eplast1.ru)

**Адрес:** 198099, г. Санкт-Петербург, ул. Калинина, дом 2, корпус 4, литера А.