

Optocoupler, Phototransistor Output, Low Input Current, with Base Connection

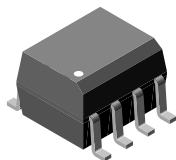

1179002

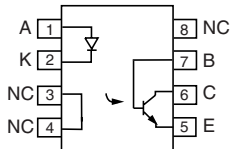

DESCRIPTION

The IL215AT/IL216AT/IL217AT are optically coupled pairs with a Gallium Arsenide infrared LED and a silicon NPN phototransistor. Signal information, including a DC level, can be transmitted by the device while maintaining a high degree of electrical isolation between input and output. The IL215AT/IL216AT/IL217AT comes in a standard SOIC-8 small outline package for surface mounting which makes it ideally suited for high density applications with limited space. In addition to eliminating through hole requirements, this package conforms to standards for surface mounted devices.

The high CTR at low input current is designed for low power consumption requirements such as CMOS microprocessor interfaces.

FEATURES

- High current transfer ratio
- Isolation test voltage, 4000 V_{RMS}
- Industry standard SOIC-8 surface mountable package
- Compatible with dual wave, vapor phase and IR reflow soldering
- Lead (Pb)-free component
- Component in accordance to RoHS 2002/95/EC and WEEE 2002/96/EC



RoHS
COMPLIANT

AGENCY APPROVALS

- UL1577, file no. E52744 system code Y
- CUL - file no. E52744, equivalent to CSA bulletin 5A
- DIN EN 60747-5-5 available with option 1

ORDER INFORMATION	
PART	REMARKS
IL215AT	CTR > 20 %, SOIC-8
IL216AT	CTR > 50 %, SOIC-8
IL217AT	CTR > 100 %, SOIC-8

ABSOLUTE MAXIMUM RATINGS				
PARAMETER	TEST CONDITION	SYMBOL	VALUE	UNIT
INPUT				
Peak reverse voltage		V_R	6.0	V
Forward continuous current		I_F	60	mA
Power dissipation		P_{diss}	90	mW
Derate linearly from 25 °C			1.2	mW/°C
OUTPUT				
Collector emitter breakdown voltage		BV_{CEO}	30	V
Emitter collector breakdown voltage		BV_{ECO}	7.0	V
Collector base breakdown voltage		BV_{CBO}	70	V
$I_{CMAX DC}$		$I_{CMAX DC}$	50	mA
I_{CMAX}	$t < 1.0$ ms	I_{CMAX}	100	mA
Power dissipation		P_{diss}	150	mW
Derate linearly from 25 °C			2.0	mW/°C



ABSOLUTE MAXIMUM RATINGS				
PARAMETER	TEST CONDITION	SYMBOL	VALUE	UNIT
COUPLER				
Isolation test voltage	1 s	V_{ISO}	4000	V_{RMS}
Total package dissipation	LED and detector	P_{tot}	240	mW
Derate linearly from 25 °C			3.2	mW/°C
Storage temperature		T_{stg}	- 55 to + 150	°C
Operating temperature		T_{amb}	- 55 to + 100	°C
Soldering time	at 260 °C		10	s

Note $T_{amb} = 25\text{ °C}$, unless otherwise specified.

Stresses in excess of the absolute maximum ratings can cause permanent damage to the device. Functional operation of the device is not implied at these or any other conditions in excess of those given in the operational sections of this document. Exposure to absolute maximum ratings for extended periods of the time can adversely affect reliability.

ELECTRICAL CHARACTERISTICS							
PARAMETER	TEST CONDITION	PART	SYMBOL	MIN.	TYP.	MAX.	UNIT
INPUT							
Forward voltage	$I_F = 1.0\text{ mA}$		V_F		1.0	1.5	V
Reverse current	$V_R = 6\text{ V}$		I_R		0.1	100	μA
Capacitance	$V_R = 0\text{ V}$		C_O		13		pF
OUTPUT							
Collector emitter breakdown voltage	$I_C = 10\text{ }\mu\text{A}$		BV_{CEO}	30			V
Emitter collector breakdown voltage	$I_E = 10\text{ }\mu\text{A}$		BV_{ECO}	7.0			V
Dark current collector emitter	$V_{CE} = 10\text{ V}$, $I_F = 0\text{ A}$		I_{CEO}		5.0	50	nA
Collector emitter capacitance	$V_{CE} = 0$		C_{CE}		10		pF
COUPLER							
Saturation voltage, collector emitter	$I_F = 1.0\text{ mA}$, $I_C = 0.1\text{ mA}$		V_{CEsat}			0.4	V
Capacitance (input to output)			C_{IO}		0.5		pF
Resistance input to output			R_{IO}		100		$G\Omega$

Note $T_{amb} = 25\text{ °C}$, unless otherwise specified.

Minimum and maximum values were tested requirements. Typical values are characteristics of the device and are the result of engineering evaluations. Typical values are for information only and are not part of the testing requirements.

CURRENT TRANSFER RATIO							
PARAMETER	TEST CONDITION	PART	SYMBOL	MIN.	TYP.	MAX.	UNIT
DC current transfer ratio	$I_F = 1.0\text{ mA}$, $V_{CE} = 5.0\text{ V}$	IL215AT	CTR_{DC}	20	50		%
		IL216AT	CTR_{DC}	50	80		%
		IL217AT	CTR_{DC}	100	130		%

SWITCHING CHARACTERISTICS							
PARAMETER	TEST CONDITION	PART	SYMBOL	MIN.	TYP.	MAX.	UNIT
Switching time	$I_F = 2.0\text{ mA}$, $R_L = 100\text{ }\Omega$, $V_{CC} = 10\text{ V}$		t_{on} , t_{off}		3.0		μs

SAFETY AND INSULATION RATINGS						
PARAMETER	TEST CONDITION	SYMBOL	MIN.	TYP.	MAX.	UNIT
Climatic classification (according to IEC 68 part 1)				55/100/21		
Comparative tracking index		CTI	175		399	
V_{IOTM}			6000			V
V_{IORM}			560			V
P_{SO}					350	mW
I_{SI}					150	mA
T_{SI}					165	°C
Creepage			4			mm
Clearance			4			mm
Insulation thickness, reinforced rated	per IEC 60950 2.10.5.1		0.2			mm

Note

As per IEC 60747-5-2, §7.4.3.8.1, this optocoupler is suitable for “safe electrical insulation” only within the safety ratings. Compliance with the safety ratings shall be ensured by means of protective circuits.

TYPICAL CHARACTERISTICS

$T_{amb} = 25\text{ °C}$, unless otherwise specified

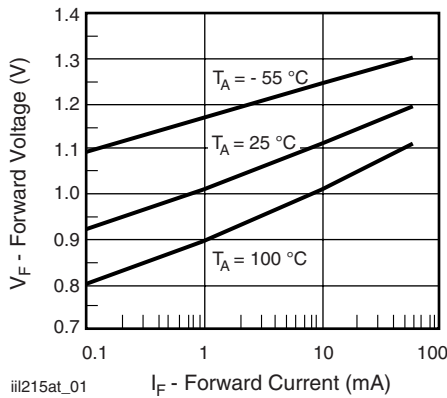

Fig. 1 - Forward Voltage vs. Forward Current

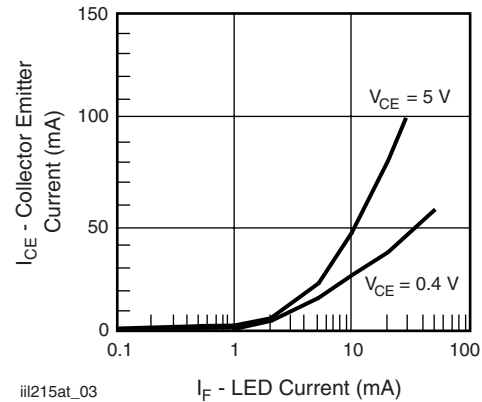

Fig. 3 - Collector Emitter Current vs. LED Current

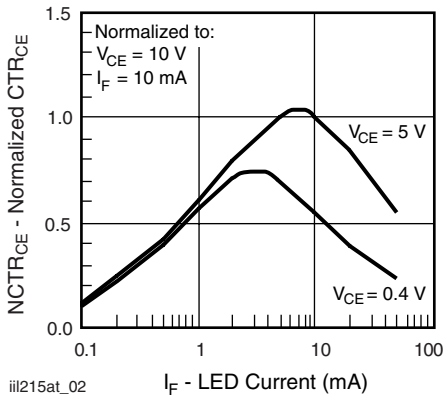

Fig. 2 - Normalized Non-Saturated and Saturated CTR_{CE} vs. LED Current

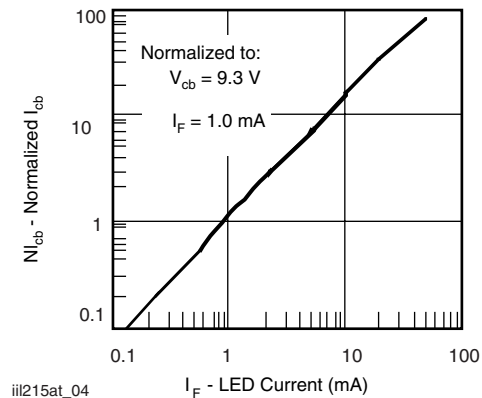

Fig. 4 - Normalized Collector Base Photocurrent vs. LED Current

Optocoupler, Phototransistor Output, Vishay Semiconductors Low Input Current, with Base Connection

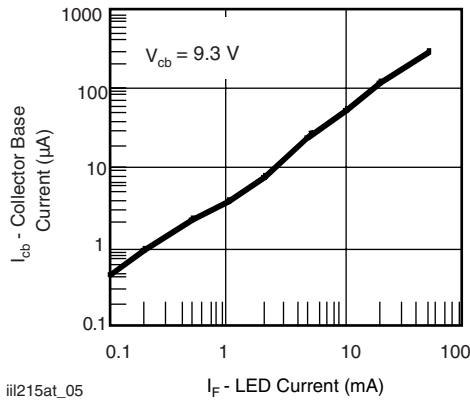

Fig. 5 - Collector Base Photocurrent vs. LED Current

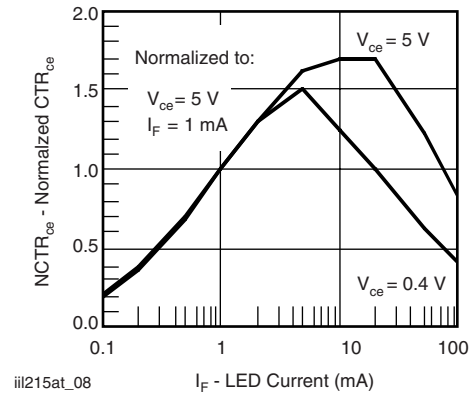

Fig. 8 - Normalized Non-Saturated and Saturated CTR_{CE} vs. LED Current

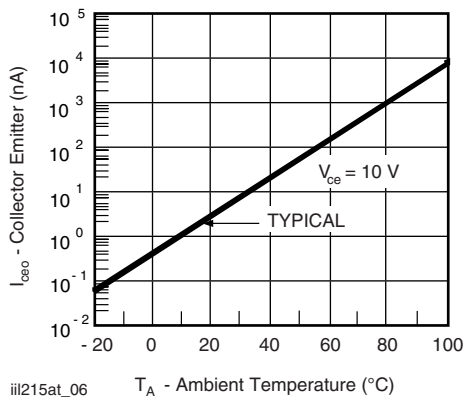

Fig. 6 - Collector Emitter Leakage Current vs. Temperature

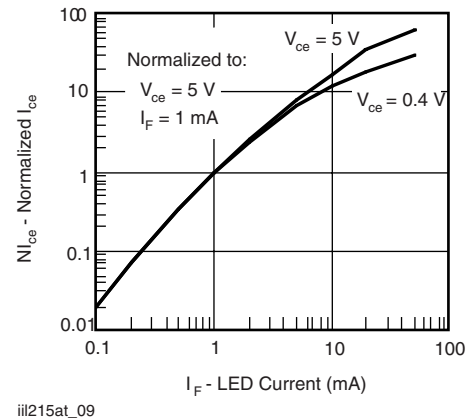

Fig. 9 - Normalized Non-Saturated and Saturated Collector Emitter Current vs. LED Current

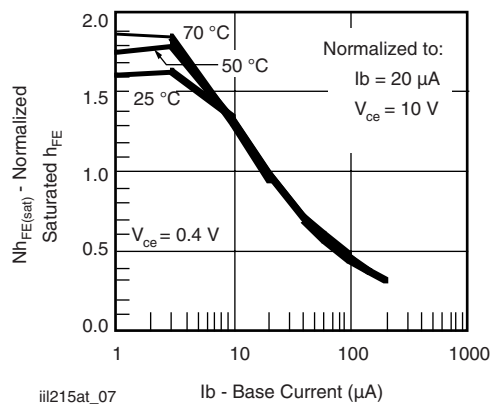

Fig. 7 - Normalized Saturated h_{FE} vs. Base Current and Temperature

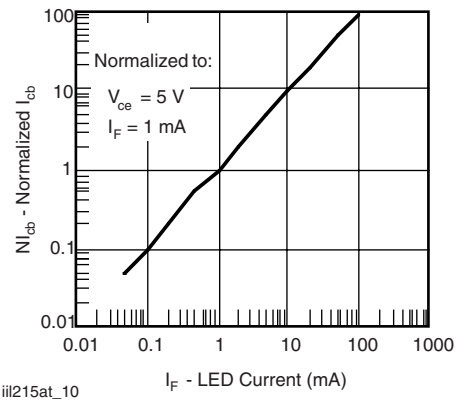

Fig. 10 - Normalized Collector Base Photocurrent vs. LED Current

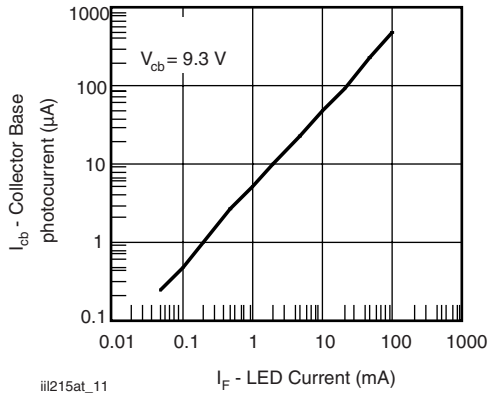

Fig. 11 - Collector Base Photocurrent vs. LED Current

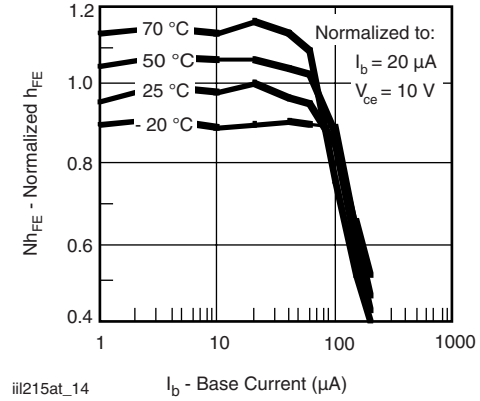

Fig. 14 - Normalized Non-Saturated h_{FE} vs. Base Current and Temperature

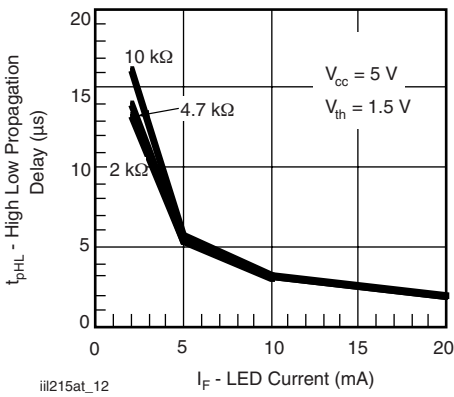

Fig. 12 - High to Low Propagation Delay vs. LED Current and Load Resistor

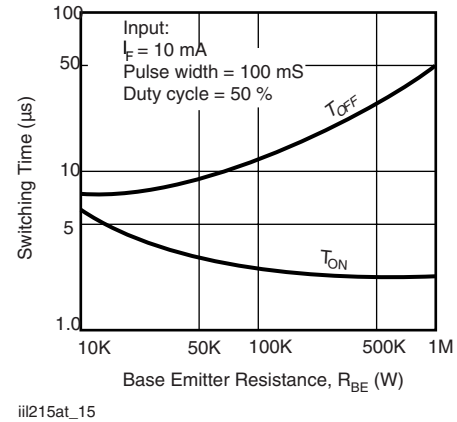

Fig. 15 - Typical Switching Characteristics vs. Base Resistance (Saturated Operation)

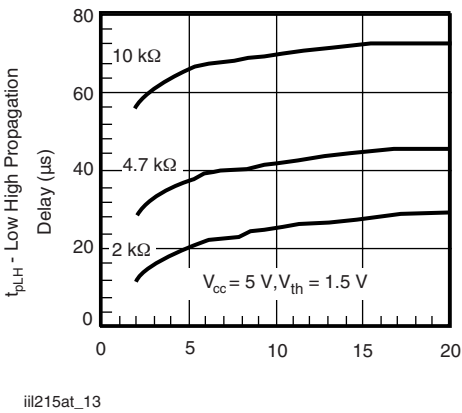

Fig. 13 - Low to High Propagation Delay vs. LED Current and Load Resistor

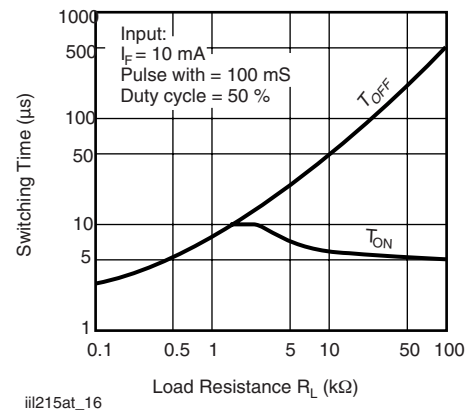
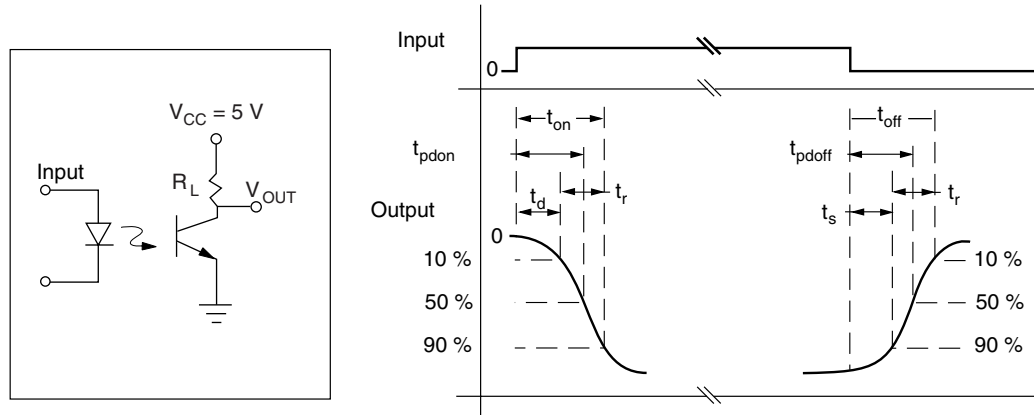

Fig. 16 - Typical Switching Times vs. Load Resistance



ii1215at_17

Fig. 17 Switching Test Circuit

PACKAGE DIMENSIONS in inches (millimeters)

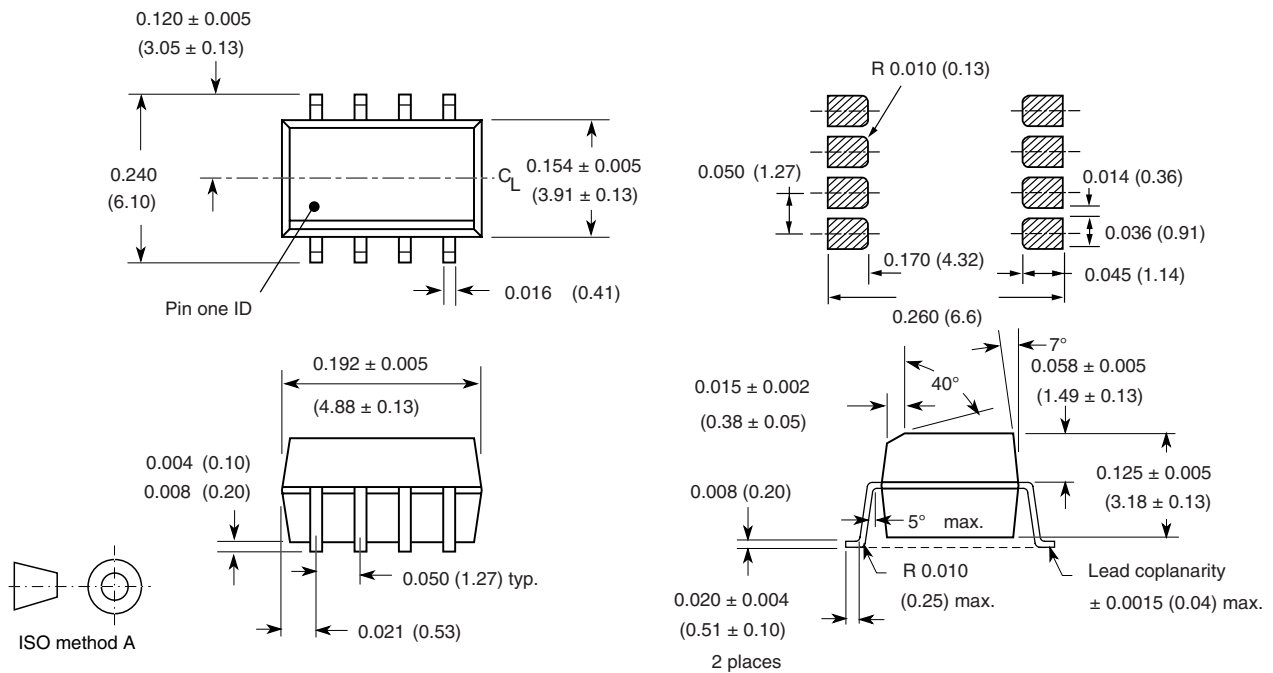

i178003

OZONE DEPLETING SUBSTANCES POLICY STATEMENT

It is the policy of Vishay Semiconductor GmbH to

1. Meet all present and future national and international statutory requirements.
2. Regularly and continuously improve the performance of our products, processes, distribution and operating systems with respect to their impact on the health and safety of our employees and the public, as well as their impact on the environment.

It is particular concern to control or eliminate releases of those substances into the atmosphere which are known as ozone depleting substances (ODSs).

The Montreal Protocol (1987) and its London Amendments (1990) intend to severely restrict the use of ODSs and forbid their use within the next ten years. Various national and international initiatives are pressing for an earlier ban on these substances.

Vishay Semiconductor GmbH has been able to use its policy of continuous improvements to eliminate the use of ODSs listed in the following documents.

1. Annex A, B and list of transitional substances of the Montreal Protocol and the London Amendments respectively.
2. Class I and II ozone depleting substances in the Clean Air Act Amendments of 1990 by the Environmental Protection Agency (EPA) in the USA.
3. Council Decision 88/540/EEC and 91/690/EEC Annex A, B and C (transitional substances) respectively.

Vishay Semiconductor GmbH can certify that our semiconductors are not manufactured with ozone depleting substances and do not contain such substances.

We reserve the right to make changes to improve technical design
and may do so without further notice.

Parameters can vary in different applications. All operating parameters must be validated for each customer application by the customer. Should the buyer use Vishay Semiconductors products for any unintended or unauthorized application, the buyer shall indemnify Vishay Semiconductors against all claims, costs, damages, and expenses, arising out of, directly or indirectly, any claim of personal damage, injury or death associated with such unintended or unauthorized use.

Vishay Semiconductor GmbH, P.O.B. 3535, D-74025 Heilbronn, Germany



Disclaimer

All product specifications and data are subject to change without notice.

Vishay Intertechnology, Inc., its affiliates, agents, and employees, and all persons acting on its or their behalf (collectively, "Vishay"), disclaim any and all liability for any errors, inaccuracies or incompleteness contained herein or in any other disclosure relating to any product.

Vishay disclaims any and all liability arising out of the use or application of any product described herein or of any information provided herein to the maximum extent permitted by law. The product specifications do not expand or otherwise modify Vishay's terms and conditions of purchase, including but not limited to the warranty expressed therein, which apply to these products.

No license, express or implied, by estoppel or otherwise, to any intellectual property rights is granted by this document or by any conduct of Vishay.

The products shown herein are not designed for use in medical, life-saving, or life-sustaining applications unless otherwise expressly indicated. Customers using or selling Vishay products not expressly indicated for use in such applications do so entirely at their own risk and agree to fully indemnify Vishay for any damages arising or resulting from such use or sale. Please contact authorized Vishay personnel to obtain written terms and conditions regarding products designed for such applications.

Product names and markings noted herein may be trademarks of their respective owners.



Компания «ЭлектроПласт» предлагает заключение долгосрочных отношений при поставках импортных электронных компонентов на взаимовыгодных условиях!

Наши преимущества:

- Оперативные поставки широкого спектра электронных компонентов отечественного и импортного производства напрямую от производителей и с крупнейших мировых складов;
- Поставка более 17-ти миллионов наименований электронных компонентов;
- Поставка сложных, дефицитных, либо снятых с производства позиций;
- Оперативные сроки поставки под заказ (от 5 рабочих дней);
- Экспресс доставка в любую точку России;
- Техническая поддержка проекта, помощь в подборе аналогов, поставка прототипов;
- Система менеджмента качества сертифицирована по Международному стандарту ISO 9001;
- Лицензия ФСБ на осуществление работ с использованием сведений, составляющих государственную тайну;
- Поставка специализированных компонентов (Xilinx, Altera, Analog Devices, Intersil, Interpoint, Microsemi, Aeroflex, Peregrine, Syfer, Eurofarad, Texas Instrument, Miteq, Cobham, E2V, MA-COM, Hittite, Mini-Circuits, General Dynamics и др.);

Помимо этого, одним из направлений компании «ЭлектроПласт» является направление «Источники питания». Мы предлагаем Вам помощь Конструкторского отдела:

- Подбор оптимального решения, техническое обоснование при выборе компонента;
- Подбор аналогов;
- Консультации по применению компонента;
- Поставка образцов и прототипов;
- Техническая поддержка проекта;
- Защита от снятия компонента с производства.



Как с нами связаться

Телефон: 8 (812) 309 58 32 (многоканальный)

Факс: 8 (812) 320-02-42

Электронная почта: org@eplast1.ru

Адрес: 198099, г. Санкт-Петербург, ул. Калинина, дом 2, корпус 4, литера А.