

Main

Range of product	Interface for discrete signals
Product or component type	Slim electromechanical output interface module
Contacts type and composition	1 NO
[Uc] control circuit voltage	24 V
Control circuit type	DC
Width pitch dimension	0.47 in (12 mm)
Line Rated Current	<= 28 mA
Short-circuit protection	6.3 A external fuse fast blow (Ik <= 1 kA AC and Ik <= 100 A DC)
[Ith] conventional free air thermal current	5 A conforming to IEC 60947-1
Local signalling	Green mechanical indicator for position of contacts and 1 green LED control signal state
Sale per indivisible quantity	5

Complementary

Control circuit voltage limits	28.8 V energization threshold: 16.9 V
Connections - terminals	Screw clamp terminal
Drop-out voltage	3.8 V
Holding current	2 mA
Power dissipation in W	0.64 W
Maximum switching voltage	150 V DC 250 V AC
System Voltage	<= 120 V DC conforming to IEC 60947-5-1 <= 230 V AC conforming to IEC 60947-5-1
Network frequency	50/60 Hz
[Ie] rated operational current	1 A AC-14 Ue: 230 V per 1000000 cycles conforming to IEC 60947-5-1 1 A AC-15 Ue: 230 V per 1000000 cycles conforming to IEC 60947-5-1 3 A AC-12 Ue: 230 V per 1000000 cycles conforming to IEC 60947-5-1 1.5 A DC-13 Ue: 24 V per 1000000 cycles conforming to IEC 60947-5-1 1.7 A DC-12 Ue: 24 V per 1000000 cycles conforming to IEC 60947-5-1
Minimum switching current	5 mA
Minimum switching voltage	5 V
Electrical reliability	<= 0.00000001
Operating time	<= 10 ms between energisation of coil and closing of NO contact DC <= 12 ms between de-energisation of coil and closing of NO contact DC
Contact bounce time	<= 5 ms
Operating rate in Hz	10 Hz at no-load 0.5 Hz at le
Mechanical durability	10000000 cycles
[Ui] rated insulation voltage	250 V conforming to VDE 0110 group C 300 V conforming to IEC 60947-1
Flame retardance	V0 conforming to UL 94
Cable cross section	0...0.01 in ² (0.27...4 mm ²), 1 wire rigid 0...0 in ² (0.34...2.5 mm ²), 1 or 2 wires flexible with cable end 0...0 in ² (0.34...2.5 mm ²), 1 or 2 wires flexible with cable end 0...0 in ² (0.6...2.5 mm ²), 1 or 2 wires flexible without cable end
Operating position	Any position
Installation category	II conforming to IEC 60947-1
Mounting support	Asymmetrical DIN rail Combination rail Symmetrical DIN rail
Product weight	0.09 lb(US) (0.041 kg)

The information provided in this documentation contains general descriptions and/or technical characteristics of the products contained herein. This documentation is not intended as a substitute for and is not to be used for determining suitability or reliability of these products for specific user applications. It is the duty of any such user or integrator to perform the appropriate and complete risk analysis, evaluation and testing of the products with respect to the relevant specific application or use thereof. Neither Schneider Electric Industries SAS nor any of its affiliates or subsidiaries shall be responsible or liable for misuse of the information contained herein.

Environment

immunity to microbreaks	1 ms
dielectric strength	1000 V for 1 minute between open contacts 2500 V for 1 minute between wired interface and earth 4000 V for 1 minute between coil circuit and contact circuits
standards	IEC 60947-5-1
product certifications	BV CSA DNV LROS (Lloyds register of shipping) UL
IP degree of protection	IP20 conforming to IEC 60529
protective treatment	TC
fire resistance	1760 °F (960 °C) conforming to IEC 60695-2-1
shock resistance	30 gn 11 ms conforming to IEC 60068-2-27
vibration resistance	3 gn (f = 10...150 Hz) conforming to IEC 60068-2-6
electromagnetic compatibility	1.2/50 µs shock waves immunity test, 0.5 kV for U < 50 V conforming to IEC 60947-1 1.2/50 µs shock waves immunity test, 1.5 kV for U < 150 V conforming to IEC 60947-1 1.2/50 µs shock waves immunity test, 2.5 kV for U < 300 V conforming to IEC 60947-1 Electromagnetic field immunity test level 3, 10 V/m between 27...1000 MHz conforming to IEC 61000-4-3 Electromagnetic field immunity test level 3, 10 V/m between 27...1000 MHz conforming to IEC 61000-4-3 Electrostatic discharge immunity test level 3, 8 kV conforming to IEC 61000-4-2 Fast transients immunity test level 3, on input/output 1 kV conforming to IEC 61000-4-4 Fast transients immunity test level 3, on power supply 2 kV conforming to IEC 61000-4-4
ambient air temperature for operation	23...104 °F (-5...40 °C) unrestricted operation 23...131 °F (-5...55 °C) from 0.85...1.1 Us -13...131 °F (-25...55 °C) at Us -13...158 °F (-25...70 °C) at Us with 8 mm space between ABR2S1...
ambient air temperature for storage	-40...176 °F (-40...80 °C)
operating altitude	<= 9842.52 ft (3000 m)
pollution degree	2 conforming to IEC 60947-1

Offer Sustainability

WARNING: This product can expose you to chemicals including:	WARNING: This product can expose you to chemicals including:
Lead and lead compounds, which is known to the State of California to cause cancer and birth defects or other reproductive harm.	Lead and lead compounds, which is known to the State of California to cause cancer and birth defects or other reproductive harm.
For more information go to www.p65warnings.ca.gov	For more information go to www.p65warnings.ca.gov

Contractual warranty

Warranty period	18 months
-----------------	-----------

Slim Electromechanical Interface Module

Dimensions

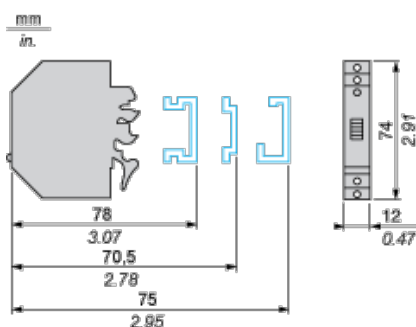

Slim Electromechanical Interface Module

Example of Application with PLC

Interfacing PLC discrete outputs

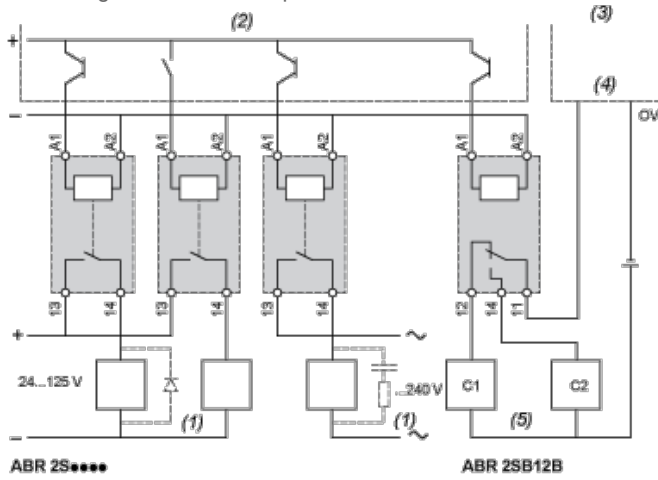

- (1) Essential on inductive loads (can be replaced with peak limiter)
- (2) PLC positive logic transistor (or relay) outputs
- (3) PLC analog inputs
- (4) Channel X
- (5) Analog sensors

Slim Electromechanical Interface Module

Circuit Diagram

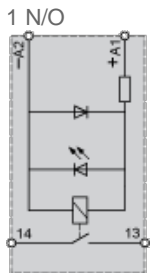

Electrical Durability of Contacts

AC Loads

Test conditions: in accordance with standard IEC 947-5-1 set up for rated control voltage.

AC-12 operating cycles in millions

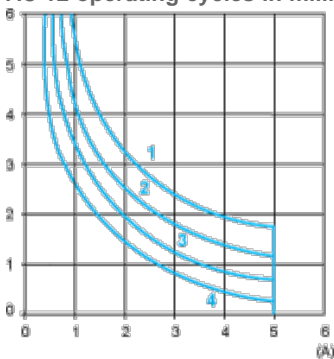

AC-12 Control of resistive loads and isolated solid state loads via optocoupler ($\cos \phi \geq 0.9$)

- (1) 24 V
- (2) 48 V
- (3) 115 V
- (4) 230 V

AC-14 and AC-15 operating cycles in millions

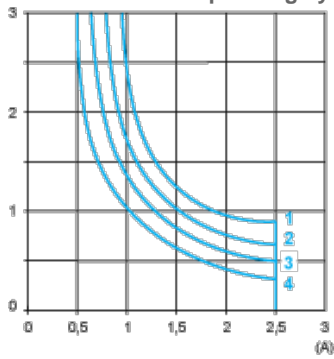

AC-14 Control of weak electro-magnetic loads of electro-magnets ≤ 72 VA (make: $\cos \phi = 0.3$, break: $\cos \phi = 0.3$)

AC-15 Control of electro-magnetic loads of electro-magnets > 72 VA (make: $\cos \phi = 0.7$, break: $\cos \phi = 0.4$)

- (1) 24 V
- (2) 48 V
- (3) 115 V
- (4) 230 V

DC Loads

Test conditions: in accordance with standard IEC 947-5-1 set up for rated control voltage.

DC-12 operating cycles in millions

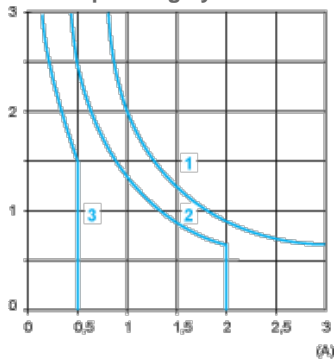

DC-12 Control of resistive loads and isolated solid state loads via optocoupler ($L/R \leq 1$ ms)

- (1) 24 V
- (2) 48 V
- (3) 115 V

DC-13 operating cycles in millions

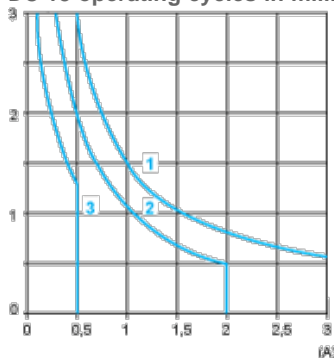

DC-13 Control of electro-magnets ($L/R \leq 2 \times (U_e \times I_e)$ in ms, with U_e : rated operating voltage and I_e : rated operating current, with a load protection diode)

- (1) 24 V
- (2) 48 V
- (3) 115 V



Компания «ЭлектроПласт» предлагает заключение долгосрочных отношений при поставках импортных электронных компонентов на взаимовыгодных условиях!

Наши преимущества:

- Оперативные поставки широкого спектра электронных компонентов отечественного и импортного производства напрямую от производителей и с крупнейших мировых складов;
- Поставка более 17-ти миллионов наименований электронных компонентов;
- Поставка сложных, дефицитных, либо снятых с производства позиций;
- Оперативные сроки поставки под заказ (от 5 рабочих дней);
- Экспресс доставка в любую точку России;
- Техническая поддержка проекта, помощь в подборе аналогов, поставка прототипов;
- Система менеджмента качества сертифицирована по Международному стандарту ISO 9001;
- Лицензия ФСБ на осуществление работ с использованием сведений, составляющих государственную тайну;
- Поставка специализированных компонентов (Xilinx, Altera, Analog Devices, Intersil, Interpoint, Microsemi, Aeroflex, Peregrine, Syfer, Eurofarad, Texas Instrument, Miteq, Cobham, E2V, MA-COM, Hittite, Mini-Circuits, General Dynamics и др.);

Помимо этого, одним из направлений компании «ЭлектроПласт» является направление «Источники питания». Мы предлагаем Вам помощь Конструкторского отдела:

- Подбор оптимального решения, техническое обоснование при выборе компонента;
- Подбор аналогов;
- Консультации по применению компонента;
- Поставка образцов и прототипов;
- Техническая поддержка проекта;
- Защита от снятия компонента с производства.



Как с нами связаться

Телефон: 8 (812) 309 58 32 (многоканальный)

Факс: 8 (812) 320-02-42

Электронная почта: org@eplast1.ru

Адрес: 198099, г. Санкт-Петербург, ул. Калинина, дом 2, корпус 4, литера А.