

NEW!

TF2 Series Miniature Snap-acting Switches

Features/Benefits

- Broad range of operating forces
- Ratings up to 16 AMPS
- Wide variety of actuator styles
- Quick connect terminations

Typical Applications

- Motor controls
- Thermostatics
- Portable tools
- Air Conditioner



Specifications

CONTACT RATING: From low level* to 16 AMPS @125/250 V AC.
 ELECTRICAL LIFE: 10,000 cycles at 16 AMPS @ 250 V AC
 INSULATION RESISTANCE: 1,000 M ohm min.
 DIELECTRIC STRENGTH: 1,500 Vrms min. @ sea level.
 OPERATING TEMPERATURE: -40°F to 185°F (-40°C to 85°C).
 OPERATING FORCE: From 18 to 330 grams at actuator button available.
 MOUNTING: Torque screws 2-5 in/lbs.

* Low Level=conditions where no arcing occurs during switching, i.e., 0.4 VA max. @ 20 V AC or DC max. Standard electrical life per UL 1054, rated for 6,000 operations.

Materials

SWITCH HOUSING: Nylon 6/6
 ACTUATOR BUTTON: Nylon 6/6
 SPRING: Stainless Steel
 PIVOT: Brass Alloy
 MOVABLE CONTACTS: See electric rating page J-88
 MOVABLE BLADE: BeCu
 STATIONARY CONTACTS: See electric rating page J-88
 TERMINALS: Brass Alloy

NOTE: Specifications and materials listed above are switches with standard options. For information on specific and custom switches, consult Customer Service Center.

Build-A-Switch

To order, simply select desired option from each category and place in the appropriate box. Available options are shown and described on pages J-88 through J-93. For additional options not shown in catalog, consult Customer Service Center.

Series _____

TF2 SP, Mom.

Operating Force _____

CC 18 grams
CF 45 grams
CG 75 grams
CH 110 grams
CJ 170 grams
EC 230 grams
EE 330 grams

Electrical Rating Chart _____

OPTION CODE	61058-1	15
F5	0.1A 125/250 V AC (Temp: 125°C) Min. 10,000 operations	0.1A 125/250 V AC µT125, 1E4
H8	6A 125/250 V AC (Temp: 125°C) Min. 10,000 operations	6A 125/250 V AC µT125, 1E4
K6	10A 125/250 V AC (Temp: 125°C) Min. 10,000 operations	10(4)A 125/250 V AC µT125, 1E4
J6	16A 125/250 V AC (Temp: 125°C) Min. 10,000 operations	16(4)A 125/250 V AC µT125, 1E4

Mounting Style _____

S Standard
V Metric

Actuator _____

P00 Pin plunger
A10 Lever roller 12.5 mm
A15 Lever roller 25.9 mm
A20 Lever roller 12.5 mm
A25 Lever roller 25.9 mm
T10 Lever 14 mm
T14 Simulated roller 24.5 mm
T15 Lever 27.5 mm
T16 Lever 31.7 mm
T17 Lever 35 mm
T20 Lever 14 mm
T24 Simulated lever 24.5 mm
T25 Lever 27.5 mm
T26 Lever 31.7 mm
T27 Lever 35 mm

Circuitry _____

C SPDT
W SPST N.C.
Y SPST N.O.

Terminations _____

40 .187" quick connect
4A .250" quick connect
5A .250" off set quick connect
5B .187" off set quick connect
60 Screw style
10 Solder

ELECTRICAL RATING	AMPS (REF.)	OPERATING FORCE						
		CC (18)	CF (45)	CG (75)	CH (110)	CJ (170)	EC (230)	EE (330)
F5	0.1	•	•	•	•	•	•	X
H8	6	X	•	•	•	•	•	•
K6	10	X	X	•	•	•	•	•
J6	16	X	X	X	•	•	•	•

• Available X Not available



Snap-acting

TF2 Series Miniature Snap-acting Switches

NEW!

SERIES

TF2 MINIATURE SNAP-ACTING SWITCHES

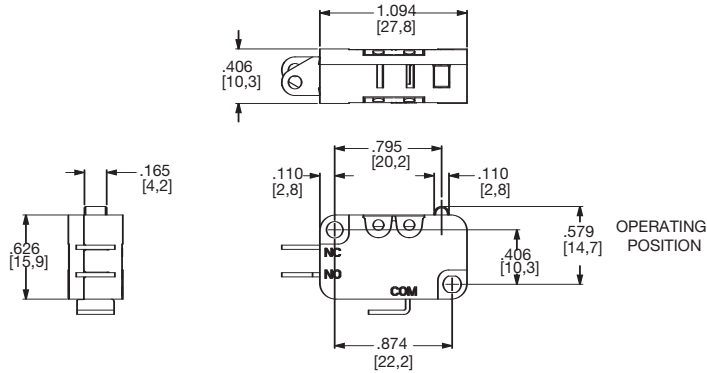

OPERATING FORCE

OPTION CODE	BASIC SWITCH OPERATING FORCE (grams)
CC	18
CF	45
CG	75
CH	110
CJ	170
EC	230
EE*	330

*Minimums may apply, consult Customer Service Center.

ELECTRICAL RATING

OPTION CODE	CONTACT MATERIAL		MOVABLE CONTACT	STATIONARY CONTACT
	RoHS COMPLIANT *	RoHS COMPATIBLE *		
F5	Yes	Yes	Gold alloy	Gold alloy
H8	Yes	Yes	Fine Silver	Fine Silver
K6	Yes	Yes		
J6	Yes	Yes	Silver alloy	

* Note: See Technical Data section of this catalog for RoHS compliant and compatible definitions and specifications.

All models



Dimensions are shown: mm
Specifications and dimensions subject to change

Snap-acting

NEW!

TF2 Series Miniature Snap-acting Switches

ELECTRICAL RATING

INTERNATIONAL RATING SYMBOLS	
μ	Microgap construction (less than 3 mm).
~	Alternating current.
T__	Maximum rated use temperature.
50E3	Cycles over 50,000 at rated current.
10E3	Cycles over 10,000 at rated current.
10(3)	Current Rating: First number represents resistive rating; second number represents inductive (motor) rating.

ELECTRICAL RATING	AMPS (REF.)	OPERATING FORCE						
		CC (18)	CF (45)	CG (75)	CH (110)	CJ (170)	EC (230)	EE (330)
F5	0.1	•	•	•	•	•	•	X
H8	6	X	•	•	•	•	•	•
K6	10	X	X	•	•	•	•	•
J6	16	X	X	X	•	•	•	•

• AVAILABLE
X NOT AVAILABLE

All models 

Consult Customer Service center for availability and delivery of nonstandard ratings.

* Low Level=conditions where no arcing occurs during switching, i.e., 0.4 VA max. @ 20 V AC or DC max.



Snap-acting

MOUNTING STYLE

S STANDARD
For 4-40 screw size

V Metric
For 3 mm screw size

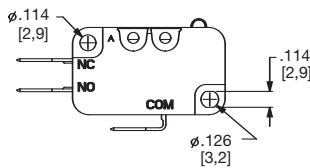

TF2 SWITCH WITH TYPE 40 (.187 QC) TERMINALS AND P00 ACTUATOR SHOWN

NOTE: TORQUE MOUNTING SCREWS 2-5 IN/LBS.

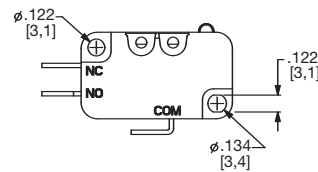

TF2 SWITCH WITH TYPE 10 (SOLDER) TERMINALS AND P00 ACTUATOR SHOWN

NOTE: TORQUE MOUNTING SCREWS 2-5 IN/LBS.

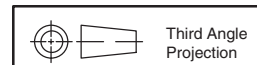

Dimensions are shown: mm
Specifications and dimensions subject to change



TF2 Series Miniature Snap-acting Switches

NEW!

ACTUATOR ■■■■■■

OPTION CODE	FIG	DIM. A	DIM. B	DIM. C	DIM. D	DIM. E
P00	2	.795 (20,2)	-	.578 ± .015 (14,70 ± 0,38)	0.068 (1,72)	-
A10	1	.828 (20,03)	.32 (8,1)	.816 ± .050 (20,73 ± 1,27)	.068 (1,73)	∅.19 (∅ 4,8)
A15	1	1.342 (34,08)	.32 (8,1)	.816 ± .050 (20,73 ± 1,27)	.141 (3,58)	∅.19 (∅ 4,8)
A20	1	1.045 (26,54)	.55 (14)	.816 ± .050 (20,73 ± 1,27)	.084 (2,14)	∅.19 (∅ 4,8)
A25	1	1.560 (39,62)	.55 (14)	.816 ± .050 (20,73 ± 1,27)	.176 (4,46)	∅.19 (∅ 4,8)
T10	3	.882 (22,39)	.32 (8,1)	.602 ± .020 (15,3 ± 0,50)	.077 (1,95)	-
T14	4	1.291 (37,91)	.32 (8,1)	.737 ± .050 (18,72 ± 1,30)	.136 (3,44)	∅.275 (∅ 7,0)
T15	3	1.405 (35,69)	.32 (8,1)	.600 ± .040 (15,24 ± 1,02)	.152 (3,86)	-
T16	3	2.338 (59,36)	.32 (8,1)	.604 ± .062 (15,35 ± 1,57)	.176 (4,46)	-
T17	3	1.708 (43,39)	.32 (8,1)	.603 ± .062 (15,33 ± 1,57)	.194 (4,94)	-
T20	3	1.10 (27,93)	.55 (14)	.604 ± .045 (15,34 ± 1,14)	.096 (2,43)	-
T24	4	1.513 (38,43)	.55 (14)	.742 ± .090 (18,84 ± 2,29)	.169 (4,3)	∅.275 (∅ 7,0)
T25	3	1.631 (41,43)	.55 (14)	.609 ± .080 (15,47 ± 2,03)	.190 (4,83)	-
T26	3	2.568 (65,23)	.55 (14)	.616 ± .125 (15,65 ± 3,18)	.220 (5,58)	-
T27	3	1.926 (48,93)	.55 (14)	.598 ± .150 (15,2 ± 3,8)	.243 (6,16)	-

NOTE: Switch characteristics chart on following page.

Lever Roller

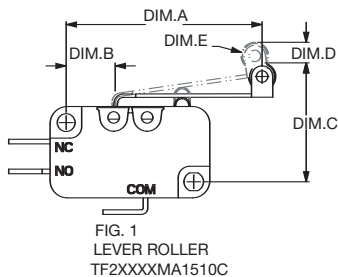

Fig 1

Pin Roller

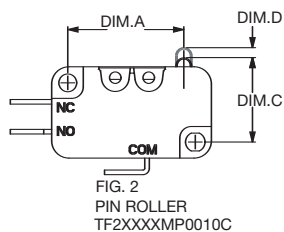

Fig 2

Lever

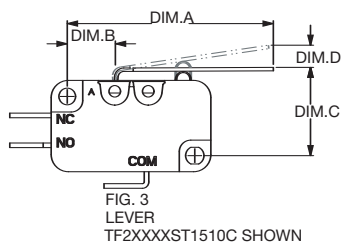

Fig 3

Simulated Roller

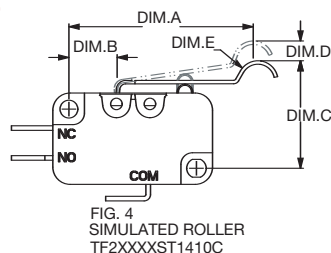

Fig 4



Dimensions are shown: mm
Specifications and dimensions subject to change

C&K

Snap-acting



NEW!

TF2 Series Miniature Snap-acting Switches

ACTUATOR

Lever Type		ACTUATOR							Pre-Travel max. mm	Max Differential max. mm	Over Travel Min. mm
		CC	CF	CG	CH Grams	CJ	EC	EE			
P00	OF	18	45	75	110	170	230	330	1.72	0.4	0.8
	RF	3	7	14	20	34	42	60			
T10	OF	18	45	75	110	170	230	330	2.8	0.5	0.6
	RF	-	6	11	17	25	35	50			
T20	OF	8	27	43	50	85	120	175	5.2	0.9	1.55
	RF	-	3	5	7	13	17	25			
T14	OF	10	28	43	65	110	140	205	5.5	1.1	1.4
	RF	-	3	5	8	14	17	31			
T24	OF	7	16	24	35	56	70	100	8.7	1.7	3.2
	RF	-	-	-	4	5	9	12			
A10	OF	20	55	80	110	170	230	330	2.7	0.45	0.6
	RF	-	5	11	16	28	31	45			
A20	OF	8	35	55	70	100	120	175	4.65	0.8	1.4
	RF	-	3	5	7	14	18	28			
A15	OF	8	30	45	65	100	125	180	4.2	1.25	1.6
	RF	-	-	5	7	12	16	25			
A25	OF	7	20	30	40	51	65	90	9.3	1.8	2.8
	RF	-	-	-	-	6	8	9			
T17	OF	16	25	35	50	80	100	140	5.5	1.2	0.55
	RF	-	2	4	6	11	14	20			
T27	OF	13	18	24	32	45	55	90	11	2.3	3.6
	RF	-	-	2	3	5	7	10			
T16	OF	15	17	32	55	85	110	150	5	1.05	1.8
	RF	-	-	4	6	12	15	22			
T26	OF	10	12	18	35	45	65	90	9.9	2.05	3.6
	RF	-	-	2	4	6	8	11			
T15	OF	18	35	50	65	110	156	210	3.6	0.75	1.3
	RF	-	3	7	11	18	22	30			
T25	OF	13	23	33	45	65	82	113	7	1.5	2.5
	RF	-	-	3	5	8	10	14			



Snap-acting

HIGH FORCE, LOW MOTION PIVOT POSITION

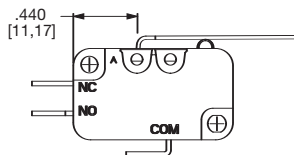

Available with actuators A10, A15, T10, T13, T14, T15, T16 and T18.

LOW FORCE, HIGH MOTION PIVOT POSITION

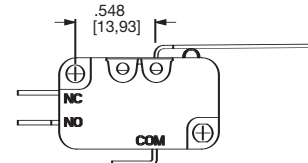

Available with actuators A20, A25, T20, T23, T24, T25, T26, and T28.

NOTE: Lever actuator options are available in either of two pivot positions. Levers located in the forward pivot position have lower forces and higher motions. Levers located in the rear pivot position have higher forces and lower motions.



Dimensions are shown: mm
Specifications and dimensions subject to change



TF2 Series Miniature Snap-acting Switches

NEW!

TERMINATIONS

40 .187" QUICK CONNECT

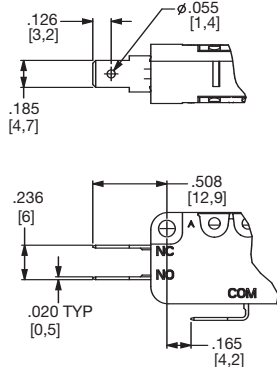

4A .250" QUICK CONNECT

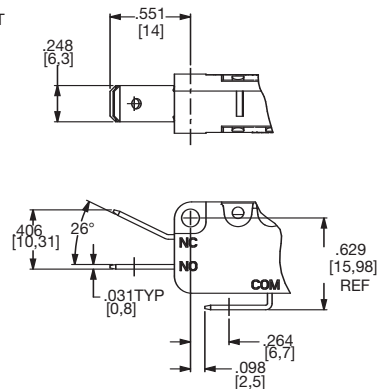

5A .250" OFF SET QUICK CONNECT

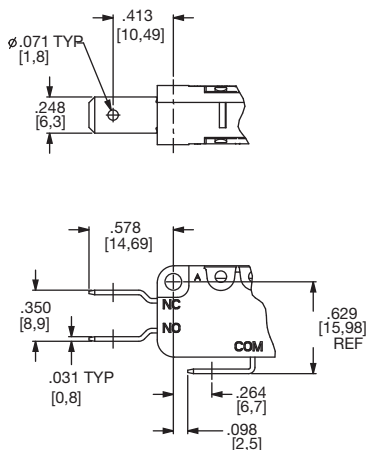

5B .187" OFF SET QUICK CONNECT

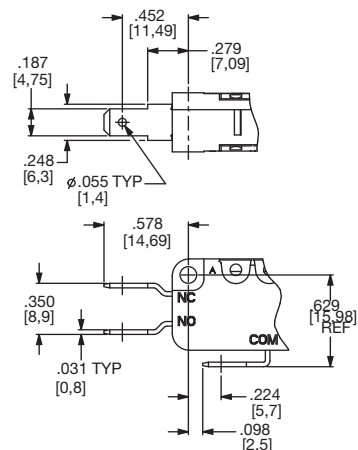

60 SCREW STYLE

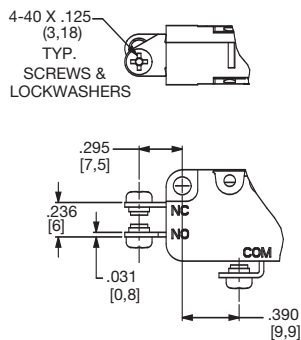

10 SOLDER

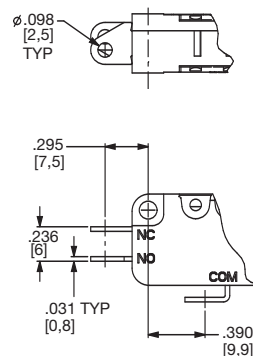

CIRCUITRY

- C** SPDT (Single Pole, Double Throw)
- W** SPST N.C. (Single Pole, Single Throw, Normally Closed)
- Y** SPST N.O. (Single Pole, Single Throw, Normally Open)



Third Angle
Projection

Dimensions are shown: mm

Specifications and dimensions subject to change



Snap-acting





Компания «ЭлектроПласт» предлагает заключение долгосрочных отношений при поставках импортных электронных компонентов на взаимовыгодных условиях!

Наши преимущества:

- Оперативные поставки широкого спектра электронных компонентов отечественного и импортного производства напрямую от производителей и с крупнейших мировых складов;
- Поставка более 17-ти миллионов наименований электронных компонентов;
- Поставка сложных, дефицитных, либо снятых с производства позиций;
- Оперативные сроки поставки под заказ (от 5 рабочих дней);
- Экспресс доставка в любую точку России;
- Техническая поддержка проекта, помощь в подборе аналогов, поставка прототипов;
- Система менеджмента качества сертифицирована по Международному стандарту ISO 9001;
- Лицензия ФСБ на осуществление работ с использованием сведений, составляющих государственную тайну;
- Поставка специализированных компонентов (Xilinx, Altera, Analog Devices, Intersil, Interpoint, Microsemi, Aeroflex, Peregrine, Syfer, Eurofarad, Texas Instrument, Miteq, Cobham, E2V, MA-COM, Hittite, Mini-Circuits, General Dynamics и др.);

Помимо этого, одним из направлений компании «ЭлектроПласт» является направление «Источники питания». Мы предлагаем Вам помощь Конструкторского отдела:

- Подбор оптимального решения, техническое обоснование при выборе компонента;
- Подбор аналогов;
- Консультации по применению компонента;
- Поставка образцов и прототипов;
- Техническая поддержка проекта;
- Защита от снятия компонента с производства.



Как с нами связаться

Телефон: 8 (812) 309 58 32 (многоканальный)

Факс: 8 (812) 320-02-42

Электронная почта: org@eplast1.ru

Адрес: 198099, г. Санкт-Петербург, ул. Калинина, дом 2, корпус 4, литера А.