

XC5/XC6/XC7/XC2/XC4 DIN Connectors Series

A Wide Variety of High-density Connectors Conform to International Standards, are Highly Reliable, and Support a Wide Range of Applications

- Lineup includes versatile DIN models that meet international DIN standards, such as standard DIN, DIN-style, and DIN fine-fit models.
- These connectors meet a variety of industrial needs.
- A comprehensive selection of accessories are available.

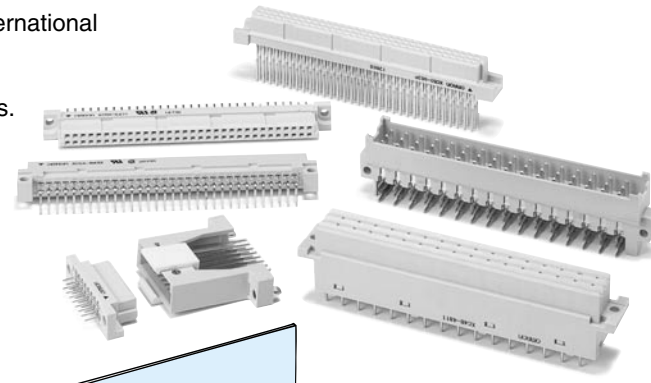

Connection Examples

● DIP Models

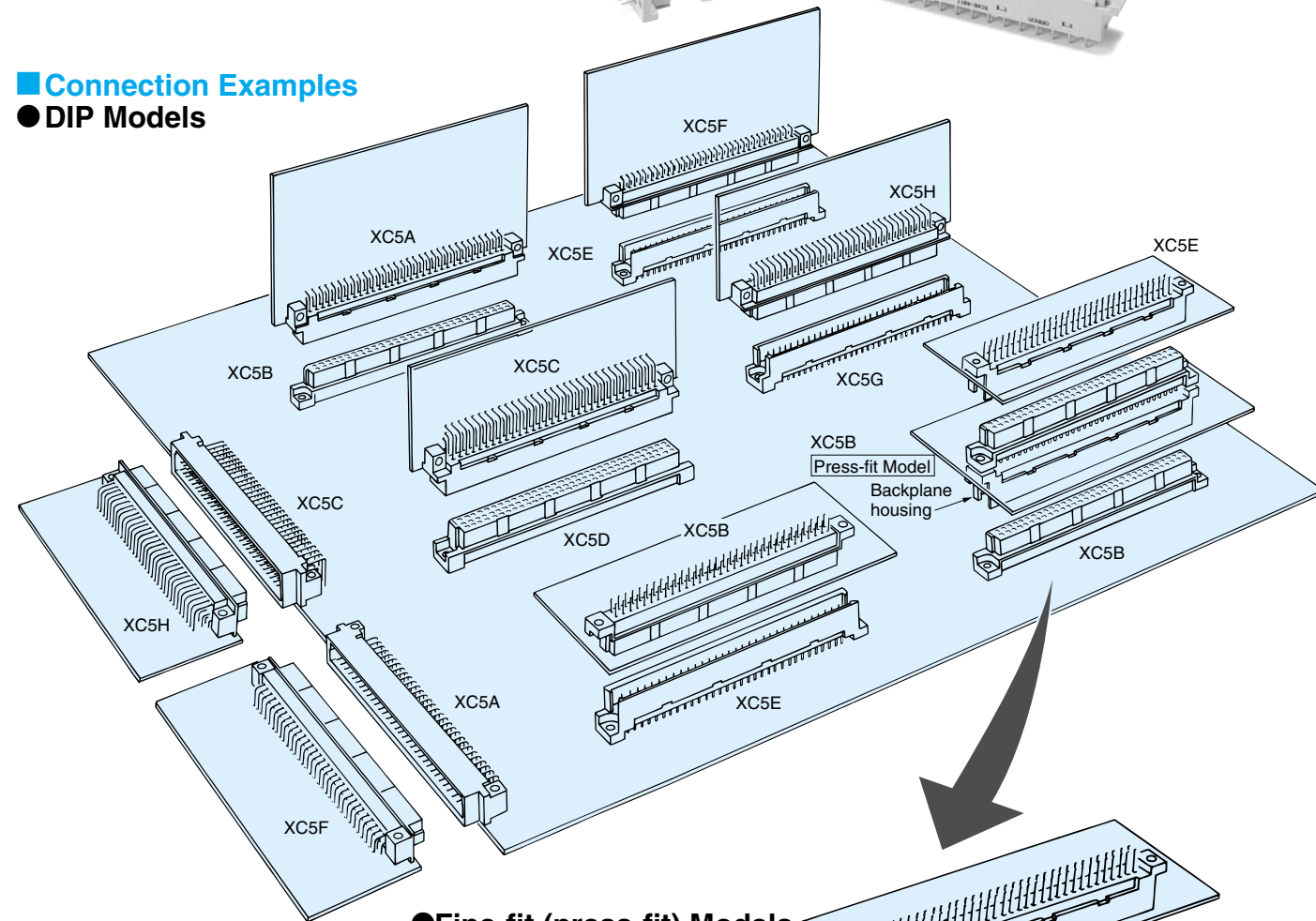

● Fine-fit (press-fit) Models with Multi-tier Stacking

Press-fit connector (with no soldering)

Backplane housing

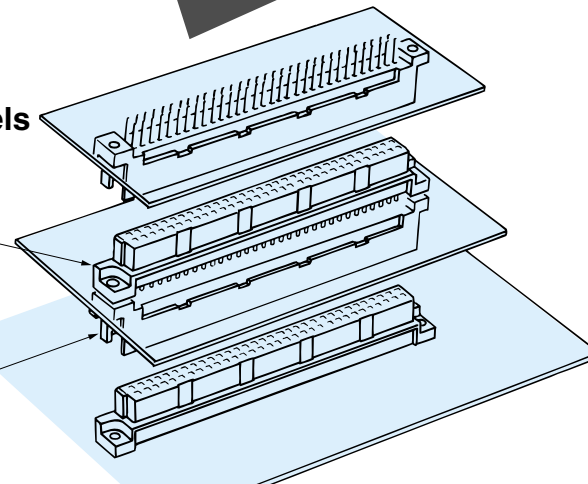

A wide variety of DIN connectors are available in addition to the following models.

XC5 DIN-style Connectors

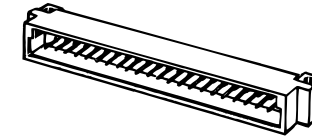

	Standard DIN	DIN style 1	DIN style 2
PCB mounting	Fixed at PCB edge	PCB surface mounting	PCB surface mounting

- Designed for PCB surface mounting and ideal for automatic soldering.

XC5K High-profile Stacking Connectors

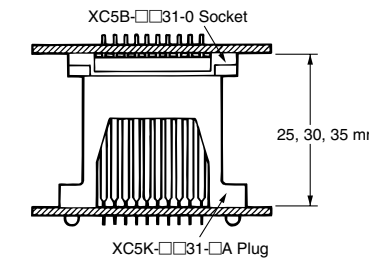
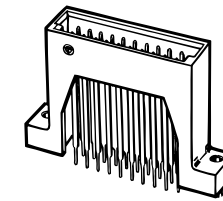

- Corresponding to a stacking height of 25, 30, or 35 mm.

XC5 Fine-fit (press-fit) Connectors

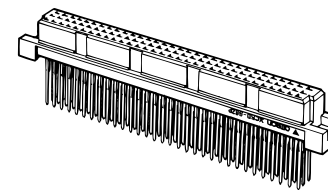

Construction of Solderless Connecting Part (Fine-fit Part)

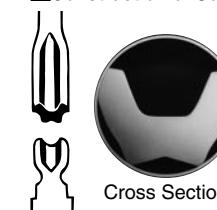

The cross section is in the shape of the letter W. The two points on the bottom work as guide rails, preventing the pins from becoming twisted. The fin parts on the upper part change shape to fit into the through hole of the PCB.

- Press-fitted to PCBs and so soldering or cleaning is required.
- Mounting method more efficient than manual soldering.
- Ideal for backplane systems.

XC5M DIN Connectors in 4 Lines with 128 Connector Poles

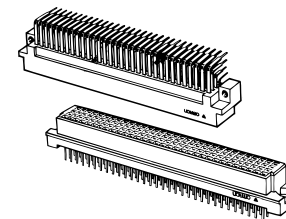

	XC5M standard DIN model	XC5M-1 DIN style 1	XC5N DIN style 3
Shape	Plug Right angle terminal	Plug Right angle terminal	Socket Straight terminal

- Multi-pole connectors in 4 lines with 128 poles based on the DIN concept.

XC6 Cable Connectors

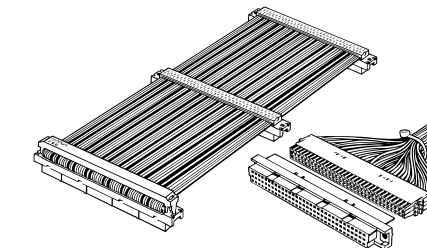
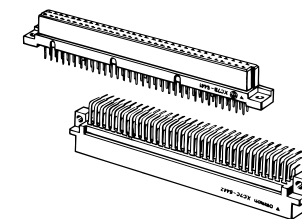

- Ideal for connecting to a variety of bus lines for rack systems.
- Allow backplanes to be constructed with ease.
- Models with 96 connector poles and models with 64 connector poles and a center-holed construction are available.

XC7 Sequence Connectors

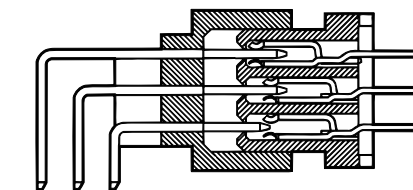
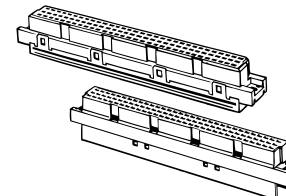

- Active lines can be connected to daughter boards after connecting power lines, and can be disconnected before disconnecting the power lines.
- High reliability ensured with an engagement length of 4 mm and the durability to withstand 5,000 insertions.
- Three-step sequential operation.

XC4 Mid- and High-current Connectors

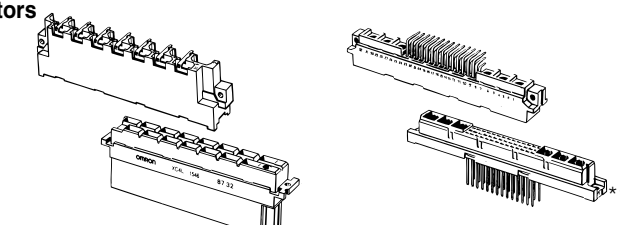
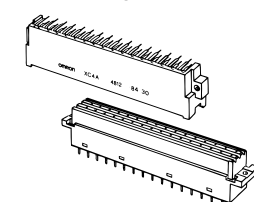

- Carry 6 to 40 A for PCB-to-PCB or PCB-to-wire applications.

*1 (high frequency model available)

XC5/XC6/XC7/XC2/XC4 DIN Connectors Series

Ordering Information

XC5 DIN Connectors

	XC5A 2-Row Plugs (DIN-B Standard Models)	XC5B 2-Row Sockets (DIN-B Standard Models)	XC5E DIP Plugs (DIN-Q Reverse Models)		
Shape	Right angle terminal XC5A-□□22 	Straight terminal XC5B-□□21 	Straight wrapping terminal XC5B-□□23 	Straight terminal XC5E-□□21 	Straight wrapping terminal XC5E-□□23 
Number of contacts	20,32,44,50,64,100	20,32,44,50,64,100	20,32,44,50,64,100		

	XC5F 2-Row Sockets (DIN-Q Reverse Models)	XC5C 3-Row Plugs (DIN-C Standard Models)	XC5D 3-Row Sockets (DIN-C Standard Models)	
Shape	Right angle terminal XC5F-□□22 	Right angle terminal XC5C-□□22 	Straight terminal XC5D-□□21 	Straight wrapping terminal XC5D-□□23 
Number of contacts	20,32,44,50,64,100	32,48,64,96	32,48,64,96	

	XC5G 3-Row Plugs (DIN-R Reverse Models)	XC5H 3-Row Sockets (DIN-R Reverse Models)
Shape	Straight terminal XC5G-□□21 	Straight wrapping terminal XC5G-□□23 
Number of contacts	48,64,96	48,64,96

XC5 DIN Connectors (Twin-contact Model)

	XC5A 2-Row Plugs (DIN Style 1)	XC5B 2-Row Sockets (DIN-style Compatible Models)	XC5E 2-Row Plugs (DIN Style 2)	XC5F 2-Row Sockets (DIN Style 2)
Shape	Right angle terminal XC5A-□□82-1 	Straight terminal XC5B-□□31-0 (with coding key) XC5B-□□31-3 	Straight terminal XC5E-□□81-2 XC5E-□□81-3 * 	Right angle terminal XC5F-□□32-2 
Number of contacts	20,24,26,30,32,44,50,60,64,90,100	10,14,16,20,24,26,30,32,40,44,50,60,64,80,90,100	10*,14*,20,24*,30,32,40*,44,50,60,64,80,90,100	20,30,32,40,44,50,60,64,90,100

	XC5K High-profile Stacking Plugs	XC5C 3-Row Plugs (DIN Style 1)	XC5D 3-Row Sockets (DIN Style Compatible)	XC5H 3-Row Sockets (DIN Style 1)
Shape	XC5K-□□31-4A with 35-mm-pitch Straight terminal XC5K-□□31-3A with 30-mm-pitch Straight terminal XC5K-□□31-2A with 25-mm-pitch Straight terminal 	Right angle terminal XC5C-□□82-1 	Straight terminal XC5D-□□31-0 	Right angle terminal XC5H-□□32-1 
Number of contacts	16,20,32	64,96	64,96	64,96

XC5 DIN Connectors (Fine-fit, W-shaped terminal type)

	XC5B 2-Row Sockets (DIN-B Fine-fit, W-terminal Models)	XC5E 2-Row Plugs (DIN-Q Fine-fit, W-terminal Models)	XC5D 3-Row Sockets (DIN-C Fine-fit, W-terminal Models)	XC5G 3-Row Plugs (DIN-R Fine-fit, W-terminal Models)
Shape	Straight terminal XC5B-□□2P-1140 *1 XC5B-□□2P-1131 *2 XC5B-□□2P-1132 *3 	Straight terminal XC5E-□□2P-1140 *1 XC5E-□□2P-1131 *2 XC5E-□□2P-1132 *3 	Straight terminal XC5D-□□2P-1140 *1 XC5D-□□2P-1131 *2 XC5D-□□2P-1132 *3 	Straight terminal XC5G-□□2P-1140 *1 XC5G-□□2P-1131 *2 XC5G-□□2P-1132 *3 
Number of contacts	32,64,100	32,64,100	48,64,96	48,64,96

*1: Terminal type/ Straight, 4mm *2: Terminal type/ Straight, 13mm *3: Terminal type/ Straight, 17mm

XC5 DIN Connectors (4-Rows and 128 Contacts type)

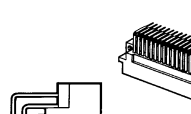
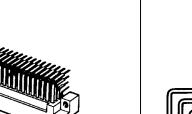
	XC5M 4-Row Plugs	XC5N 4-Row Sockets
Shape	Standard DIN Right angle type terminal XC5M-0222 	DIN Style Right angle terminal XC5M-0222-1 
Number of contacts	128	128

XC6 DIN Connectors (Cable Connecting type)

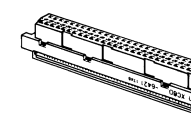
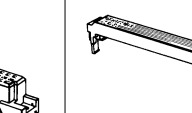
	XC6D Center-holed 2-Row Flat Cables (DIN-C Models)	XC6H 3-Row Flat Cable (DIN-C Models)
Shape	Socket XC6D-6421 	Strain relief XC6T-644 
Number of contacts	64	96

XC6V DIN Connectors (IDC Connectors for Discretedwire)

	Unit housing XC6M-96 	Housing without contacts XC6T-32 
Shape		

XC5/XC6/XC7/XC2/XC4

DIN Connectors Series



Ordering Information

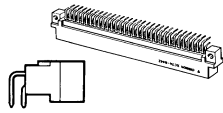
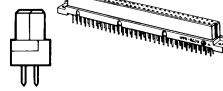
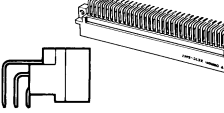
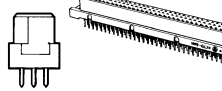

XC7 DIN Socket Sequence Connectors

	XC7A 2-Row Plugs	XC7B 2-Row Sockets	XC7C 3-Row Plugs	XC7D 3-Row Sockets
Shape	Right angle terminal XC7A-□□42-N001 *1 XC7A-□□42-N003 *2 	Straight terminal XC7B-□□41-N001 *1 XC7B-□□41-N003 *2 	Right angle terminal XC7C-9642-N001 *1 XC7C-9642-N003 *2 	Straight terminal XC7D-9641-N001 *1 XC7D-9641-N003 *2 
Number of contacts	64,90,100	64,90,100	96	96

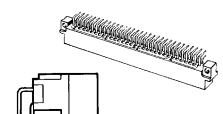
*1:N001→Normal *2:N003→Sequence

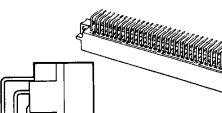
XC2 DIN Connectors

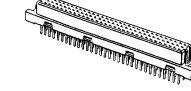
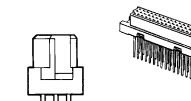
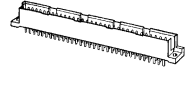
	XC2A 2-Row Plugs (DIN-B standard models)	XC2B 2-Row Sockets (DIN-B standard models)		XC2C 3-Row Plugs (DIN-C standard models)
Shape	Right angle terminal XC2A-6412 	Straight terminal XC2B-6411 	Straight wrapping terminal XC2B-6413 	Right angle terminal XC2C-□□12 
Number of contacts	64	64		64,96

	XC2D 3-Row Sockets (DIN-C standard)		XC2E 2-Row Plugs (DIN-Q Reverse model)	
Shape	Straight terminal XC2D-□□11 	Straight wrapping terminal XC2D-□□13 	Straight terminal XC2E-6411 	Straight wrapping terminal XC2E-6413 
Number of contacts	64,96		64	

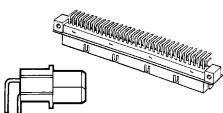
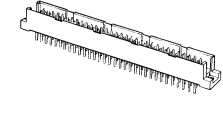
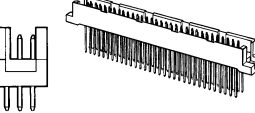
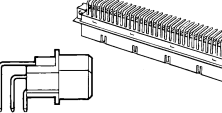
	XC2F 2-Row Sockets (DIN-Q Reverse model)	XC2G 3-Row Plugs (DIN-R Reverse model)		XC2H 3-Row Sockets (DIN-R Reverse model)
Shape	Right angle terminal XC2F-6412 	Straight terminal XC2G-□□11 	Straight wrapping terminal XC2G-□□13 	Right angle terminal XC2H-□□12 
Number of contacts	64	64,96		64,96

XC4 DIN types

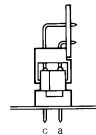
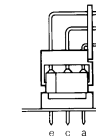
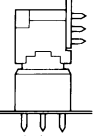
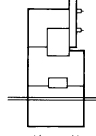
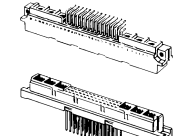
Models	XC4G/H	XC4E/F	XC4A/B	XC4K/L	XC4M/N
DIN	D	E	F	H	M
Shape					

XC4 DIN Connectors (Medium and High-current Connectors)

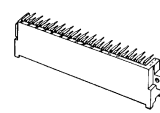
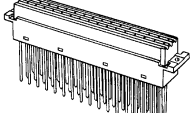
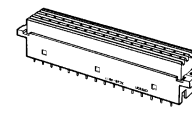
	XC4A Plugs (DIN-F)	XC4B Sockets (DIN-F)	
Shape	Right angle terminal XC4A-4812 	Straight terminal XC4B-4813 	Wrapping terminal XC4B-4811 
Number of contacts	48	48	

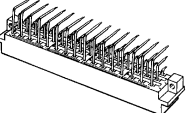
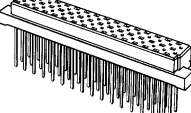
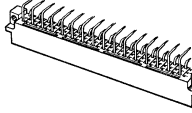
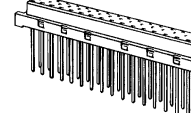
	XC4E Plugs (DIN-E)	XC4F Sockets (DIN-E)	XC4G Plugs (DIN-D)	XC4H Sockets (DIN-D)
Shape	Right angle terminal XC4E-□□12 	Wrapping terminal XC4F-□□13 	Right angle terminal XC4G-3212 	Wrapping terminal XC4H-3213 
Number of contacts	32,48	32,48	32	32

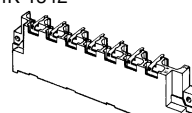
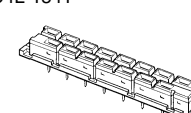
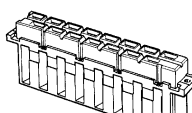
	XC4K Plugs (DIN-H)	XC4L Sockets (DIN-H)	XC4L Sockets(with Fastening Terminals)(DIN-H)
Shape	Right angle terminal XC4K-1542 	Straight terminal XC4L-1541 	with Fasten Terminal XC4L-1546 
Number of contacts	15	15	15

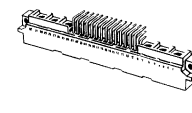
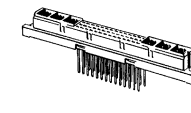
	XC4M Plugs (DIN-M)	XC4N Sockets (DIN-M)
Shape	Right angle terminal XC4M-□□12 	Straight wrapping terminal XC4N-□□13 
Number of contacts	2/78, 4/60, 6/42 *	2/78, 4/60, 6/42 *

*: contacts/ Number of signal circuit poles

XC4W High-current Contacts (for XC4M/XC4N)

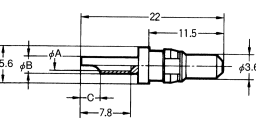
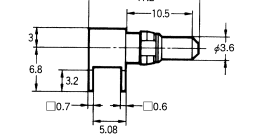
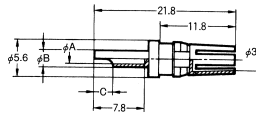
	Plug with Solder Cup Terminal XC4W-□□11	Plug with L-shaped Solder Terminal XC4W-0412	Receptacle with Solder Cup Terminal XC4W-□□11
Shape			
Number of contacts	1,2,4	4	11,12,14

XC4W Co-axial Contacts for XC4M/XC4N

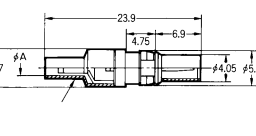
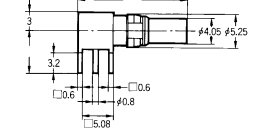
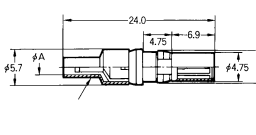
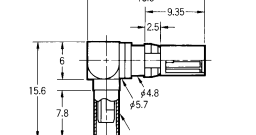
	XC4W-2111(φ2.2) XC4W-2211(φ3.2)	XC4W-2014	XC4W-3111(φ2.2) XC4W-3211(φ3.2)	XC4W-3112(φ2.2) XC4W-3212(φ3.2)
Shape				



Компания «ЭлектроПласт» предлагает заключение долгосрочных отношений при поставках импортных электронных компонентов на взаимовыгодных условиях!

Наши преимущества:

- Оперативные поставки широкого спектра электронных компонентов отечественного и импортного производства напрямую от производителей и с крупнейших мировых складов;
- Поставка более 17-ти миллионов наименований электронных компонентов;
- Поставка сложных, дефицитных, либо снятых с производства позиций;
- Оперативные сроки поставки под заказ (от 5 рабочих дней);
- Экспресс доставка в любую точку России;
- Техническая поддержка проекта, помощь в подборе аналогов, поставка прототипов;
- Система менеджмента качества сертифицирована по Международному стандарту ISO 9001;
- Лицензия ФСБ на осуществление работ с использованием сведений, составляющих государственную тайну;
- Поставка специализированных компонентов (Xilinx, Altera, Analog Devices, Intersil, Interpoint, Microsemi, Aeroflex, Peregrine, Syfer, Eurofarad, Texas Instrument, Miteq, Cobham, E2V, MA-COM, Hittite, Mini-Circuits, General Dynamics и др.);

Помимо этого, одним из направлений компании «ЭлектроПласт» является направление «Источники питания». Мы предлагаем Вам помощь Конструкторского отдела:

- Подбор оптимального решения, техническое обоснование при выборе компонента;
- Подбор аналогов;
- Консультации по применению компонента;
- Поставка образцов и прототипов;
- Техническая поддержка проекта;
- Защита от снятия компонента с производства.



Как с нами связаться

Телефон: 8 (812) 309 58 32 (многоканальный)

Факс: 8 (812) 320-02-42

Электронная почта: org@eplast1.ru

Адрес: 198099, г. Санкт-Петербург, ул. Калинина, дом 2, корпус 4, литера А.