

XC5/XC6/XC7/XC2/XC4 DIN Connectors Series

A Wide Variety of High-density Connectors Conform to International Standards, are Highly Reliable, and Support a Wide Range of Applications

- Lineup includes versatile DIN models that meet international DIN standards, such as standard DIN, DIN-style, and DIN fine-fit models.
- These connectors meet a variety of industrial needs.
- A comprehensive selection of accessories are available.



Connection Examples

● DIP Models



● Fine-fit (press-fit) Models with Multi-tier Stacking

Press-fit connector (with no soldering)

Backplane housing



A wide variety of DIN connectors are available in addition to the following models.

XC5 DIN-style Connectors



| | Standard DIN | DIN style 1 | DIN style 2 |
|--------------|-------------------|----------------------|----------------------|
| PCB mounting | Fixed at PCB edge | PCB surface mounting | PCB surface mounting |

- Designed for PCB surface mounting and ideal for automatic soldering.

XC5K High-profile Stacking Connectors

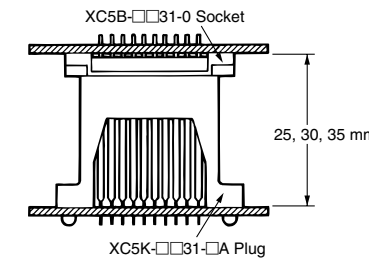
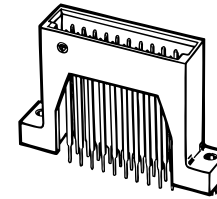

- Corresponding to a stacking height of 25, 30, or 35 mm.

XC5 Fine-fit (press-fit) Connectors



Construction of Solderless Connecting Part (Fine-fit Part)

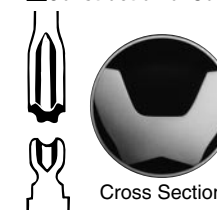

The cross section is in the shape of the letter W. The two points on the bottom work as guide rails, preventing the pins from becoming twisted. The fin parts on the upper part change shape to fit into the through hole of the PCB.

- Press-fitted to PCBs and so soldering or cleaning is required.
- Mounting method more efficient than manual soldering.
- Ideal for backplane systems.

XC5M DIN Connectors in 4 Lines with 128 Connector Poles

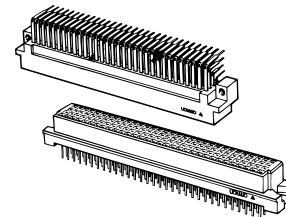

| | XC5M standard DIN model | XC5M-1 DIN style 1 | XC5N DIN style 3 |
|-------|---------------------------|---------------------------|--------------------------|
| Shape | Plug Right angle terminal | Plug Right angle terminal | Socket Straight terminal |

- Multi-pole connectors in 4 lines with 128 poles based on the DIN concept.

XC6 Cable Connectors

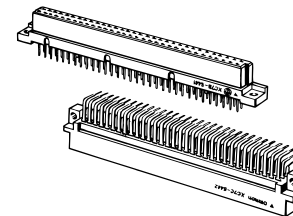

- Ideal for connecting to a variety of bus lines for rack systems.
- Allow backplanes to be constructed with ease.
- Models with 96 connector poles and models with 64 connector poles and a center-holed construction are available.

XC7 Sequence Connectors

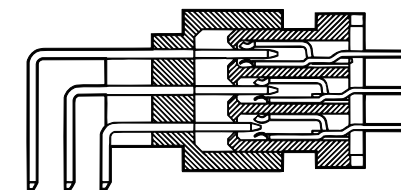
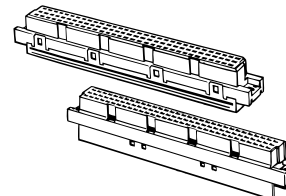

- Active lines can be connected to daughter boards after connecting power lines, and can be disconnected before disconnecting the power lines.
- High reliability ensured with an engagement length of 4 mm and the durability to withstand 5,000 insertions.
- Three-step sequential operation.

XC4 Mid- and High-current Connectors

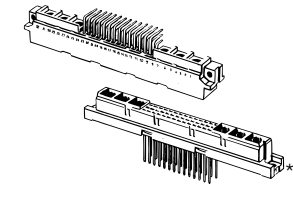
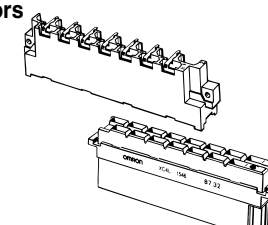
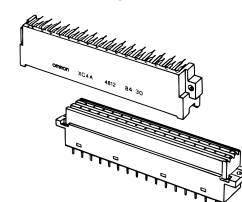

- Carry 6 to 40 A for PCB-to-PCB or PCB-to-wire applications.

*1 (high frequency model available)

XC5/XC6/XC7/XC2/XC4 DIN Connectors Series

Ordering Information

XC5 DIN Connectors

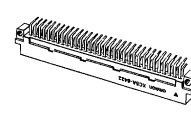
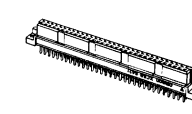
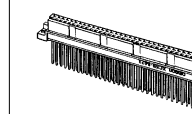
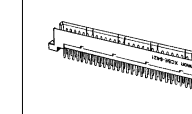
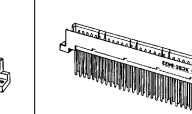
| | XC5A 2-Row Plugs (DIN-B Standard Models) | XC5B 2-Row Sockets (DIN-B Standard Models) | XC5E DIP Plugs (DIN-Q Reverse Models) | | |
|--------------------|--|---|--|--|--|
| Shape | Right angle terminal XC5A-□□22  | Straight terminal XC5B-□□21  | Straight wrapping terminal XC5B-□□23  | Straight terminal XC5E-□□21  | Straight wrapping terminal XC5E-□□23  |
| Number of contacts | 20,32,44,50,64,100 | 20,32,44,50,64,100 | 20,32,44,50,64,100 | | |

| | XC5F 2-Row Sockets (DIN-Q Reverse Models) | XC5C 3-Row Plugs (DIN-C Standard Models) | XC5D 3-Row Sockets (DIN-C Standard Models) | |
|--------------------|--|--|---|---|
| Shape | Right angle terminal XC5F-□□22  | Right angle terminal XC5C-□□22  | Straight terminal XC5D-□□21  | Straight wrapping terminal XC5D-□□23  |
| Number of contacts | 20,32,44,50,64,100 | 32,48,64,96 | 32,48,64,96 | |

| | XC5G 3-Row Plugs (DIN-R Reverse Models) | XC5H 3-Row Sockets (DIN-R Reverse Models) |
|--------------------|---|--|
| Shape | Straight terminal XC5G-□□21  | Straight wrapping terminal XC5G-□□23  |
| Number of contacts | 48,64,96 | 48,64,96 |

XC5 DIN Connectors (Twin-contact Model)

| | XC5A 2-Row Plugs (DIN Style 1) | XC5B 2-Row Sockets (DIN-style Compatible Models) | XC5E 2-Row Plugs (DIN Style 2) | XC5F 2-Row Sockets (DIN Style 2) |
|--------------------|--|--|--|---|
| Shape | Right angle terminal XC5A-□□82-1  | Straight terminal XC5B-□□31-0 (with coding key) XC5B-□□31-3  | Straight terminal XC5E-□□81-2 XC5E-□□81-3 *  | Right angle terminal XC5F-□□32-2  |
| Number of contacts | 20,24,26,30,32,44,50,60,64,90,100 | 10,14,16,20,24,26,30,32,40,44,50,60,64,80,90,100 | 10*,14*,20,24*,30,32,40*,44,50,60,64,80,90,100 | 20,30,32,40,44,50,60,64,90,100 |

| | XC5K High-profile Stacking Plugs | XC5C 3-Row Plugs (DIN Style 1) | XC5D 3-Row Sockets (DIN Style Compatible) | XC5H 3-Row Sockets (DIN Style 1) |
|--------------------|--|--|---|---|
| Shape | XC5K-□□31-4A with 35-mm-pitch Straight terminal XC5K-□□31-3A with 30-mm-pitch Straight terminal XC5K-□□31-2A with 25-mm-pitch Straight terminal  | Right angle terminal XC5C-□□82-1  | Straight terminal XC5D-□□31-0  | Right angle terminal XC5H-□□32-1  |
| Number of contacts | 16,20,32 | 64,96 | 64,96 | 64,96 |

XC5 DIN Connectors (Fine-fit, W-shaped terminal type)

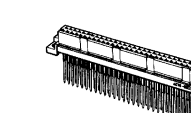
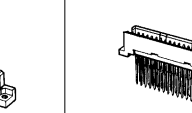
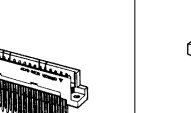
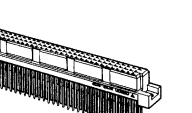
| | XC5B 2-Row Sockets (DIN-B Fine-fit, W-terminal Models) | XC5E 2-Row Plugs (DIN-Q Fine-fit, W-terminal Models) | XC5D 3-Row Sockets (DIN-C Fine-fit, W-terminal Models) | XC5G 3-Row Plugs (DIN-R Fine-fit, W-terminal Models) |
|--------------------|---|---|---|---|
| Shape | Straight terminal XC5B-□□2P-1140 *1 XC5B-□□2P-1131 *2 XC5B-□□2P-1132 *3  | Straight terminal XC5E-□□2P-1140 *1 XC5E-□□2P-1131 *2 XC5E-□□2P-1132 *3  | Straight terminal XC5D-□□2P-1140 *1 XC5D-□□2P-1131 *2 XC5D-□□2P-1132 *3  | Straight terminal XC5G-□□2P-1140 *1 XC5G-□□2P-1131 *2 XC5G-□□2P-1132 *3  |
| Number of contacts | 32,64,100 | 32,64,100 | 48,64,96 | 48,64,96 |

*1: Terminal type/ Straight, 4mm *2: Terminal type/ Straight, 13mm *3: Terminal type/ Straight, 17mm

XC5 DIN Connectors (4-Rows and 128 Contacts type)

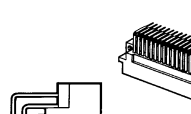
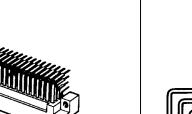
| | XC5M 4-Row Plugs | XC5N 4-Row Sockets |
|--------------------|--|--|
| Shape | Standard DIN Right angle type terminal XC5M-0222  | DIN Style Right angle terminal XC5M-0222-1  |
| Number of contacts | 128 | 128 |

XC6 DIN Connectors (Cable Connecting type)

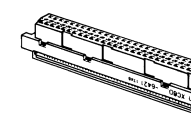
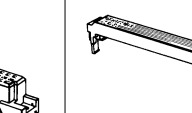
| | XC6D Center-holed 2-Row Flat Cables (DIN-C Models) | XC6H 3-Row Flat Cable (DIN-C Models) |
|--------------------|--|--|
| Shape | Socket XC6D-6421  | Strain relief XC6T-644  |
| Number of contacts | 64 | 96 |

XC6V DIN Connectors (IDC Connectors for Discretedwire)

| | Unit housing XC6M-96 | Housing without contacts XC6T-32 |
|-------|---|---|
| Shape |  |  |

XC5/XC6/XC7/XC2/XC4

DIN Connectors Series

Ordering Information

XC7 DIN Socket Sequence Connectors

| | XC7A 2-Row Plugs | XC7B 2-Row Sockets | XC7C 3-Row Plugs | XC7D 3-Row Sockets |
|--------------------|--|---|--|---|
| Shape | Right angle terminal XC7A-□□42-N001 *1 XC7A-□□42-N003 *2 | Straight terminal XC7B-□□41-N001 *1 XC7B-□□41-N003 *2 | Right angle terminal XC7C-9642-N001 *1 XC7C-9642-N003 *2 | Straight terminal XC7D-9641-N001 *1 XC7D-9641-N003 *2 |
| Number of contacts | 64,90,100 | 64,90,100 | 96 | 96 |

*1:N001→Normal *2:N003→Sequence

XC2 DIN Connectors

| | XC2A 2-Row Plugs (DIN-B standard models) | XC2B 2-Row Sockets (DIN-B standard models) | | XC2C 3-Row Plugs (DIN-C standard models) |
|--------------------|--|--|---|--|
| Shape | Right angle terminal XC2A-6412 | Straight terminal XC2B-6411 | Straight wrapping terminal XC2B-6413 | Right angle terminal XC2C-□□12 |
| Number of contacts | 64 | 64 | 64 | 64,96 |

| | XC2D 3-Row Sockets (DIN-C standard) | | XC2E 2-Row Plugs (DIN-Q Reverse model) | |
|--------------------|-------------------------------------|---|--|---|
| Shape | Straight terminal XC2D-□□11 | Straight wrapping terminal XC2D-□□13 | Straight terminal XC2E-6411 | Straight wrapping terminal XC2E-6413 |
| Number of contacts | 64,96 | 64,96 | 64 | 64 |

| | XC2F 2-Row Sockets (DIN-Q Reverse model) | XC2G 3-Row Plugs (DIN-R Reverse model) | | XC2H 3-Row Sockets (DIN-R Reverse model) |
|--------------------|--|--|---|--|
| Shape | Right angle terminal XC2F-6412 | Straight terminal XC2G-□□11 | Straight wrapping terminal XC2G-□□13 | Right angle terminal XC2H-□□12 |
| Number of contacts | 64 | 64,96 | 64,96 | 64,96 |

XC4 DIN types

| Models | XC4G/H | XC4E/F | XC4A/B | XC4K/L | XC4M/N |
|--------|--------|--------|--------|--------|--------|
| DIN | D | E | F | H | M |
| Shape | | | | | |

XC4 DIN Connectors (Medium and High-current Connectors)

| | XC4A Plugs (DIN-F) | XC4B Sockets (DIN-F) | |
|--------------------|---------------------------------------|------------------------------------|------------------------------------|
| Shape | Right angle terminal XC4A-4812 | Straight terminal XC4B-4813 | Wrapping terminal XC4B-4811 |
| Number of contacts | 48 | 48 | 48 |

| | XC4E Plugs (DIN-E) | XC4F Sockets (DIN-E) | XC4G Plugs (DIN-D) | XC4H Sockets (DIN-D) |
|--------------------|---------------------------------------|------------------------------------|---------------------------------------|------------------------------------|
| Shape | Right angle terminal XC4E-□□12 | Wrapping terminal XC4F-□□13 | Right angle terminal XC4G-3212 | Wrapping terminal XC4H-3213 |
| Number of contacts | 32,48 | 32,48 | 32 | 32 |

| | XC4K Plugs (DIN-H) | XC4L Sockets (DIN-H) | XC4L Sockets(with Fastening Terminals)(DIN-H) |
|--------------------|---------------------------------------|------------------------------------|---|
| Shape | Right angle terminal XC4K-1542 | Straight terminal XC4L-1541 | with Fasten Terminal XC4L-1546 |
| Number of contacts | 15 | 15 | 15 |

| | XC4M Plugs (DIN-M) | XC4N Sockets (DIN-M) |
|--------------------|---------------------------------------|---|
| Shape | Right angle terminal XC4M-□□12 | Straight wrapping terminal XC4N-□□13 |
| Number of contacts | 2/78, 4/60, 6/42 * | 2/78, 4/60, 6/42 * |

*: contacts/ Number of signal circuit poles

XC4W High-current Contacts (for XC4M/XC4N)

| | Plug with Solder Cup Terminal XC4W-□□11 | Plug with L-shaped Solder Terminal XC4W-0412 | Receptacle with Solder Cup Terminal XC4W-□□11 |
|--------------------|--|---|--|
| Shape | | | |
| Number of contacts | 1,2,4 | 4 | 11,12,14 |

XC4W Co-axial Contacts for XC4M/XC4N

| | XC4W-2111(φ2.2) XC4W-2211(φ3.2) | XC4W-2014 | XC4W-3111(φ2.2) XC4W-3211(φ3.2) | XC4W-3112(φ2.2) XC4W-3212(φ3.2) |
|-------|------------------------------------|-----------|------------------------------------|------------------------------------|
| Shape | | | | |



Компания «ЭлектроПласт» предлагает заключение долгосрочных отношений при поставках импортных электронных компонентов на взаимовыгодных условиях!

Наши преимущества:

- Оперативные поставки широкого спектра электронных компонентов отечественного и импортного производства напрямую от производителей и с крупнейших мировых складов;
- Поставка более 17-ти миллионов наименований электронных компонентов;
- Поставка сложных, дефицитных, либо снятых с производства позиций;
- Оперативные сроки поставки под заказ (от 5 рабочих дней);
- Экспресс доставка в любую точку России;
- Техническая поддержка проекта, помощь в подборе аналогов, поставка прототипов;
- Система менеджмента качества сертифицирована по Международному стандарту ISO 9001;
- Лицензия ФСБ на осуществление работ с использованием сведений, составляющих государственную тайну;
- Поставка специализированных компонентов (Xilinx, Altera, Analog Devices, Intersil, Interpoint, Microsemi, Aeroflex, Peregrine, Syfer, Eurofarad, Texas Instrument, Miteq, Cobham, E2V, MA-COM, Hittite, Mini-Circuits, General Dynamics и др.);

Помимо этого, одним из направлений компании «ЭлектроПласт» является направление «Источники питания». Мы предлагаем Вам помощь Конструкторского отдела:

- Подбор оптимального решения, техническое обоснование при выборе компонента;
- Подбор аналогов;
- Консультации по применению компонента;
- Поставка образцов и прототипов;
- Техническая поддержка проекта;
- Защита от снятия компонента с производства.



Как с нами связаться

Телефон: 8 (812) 309 58 32 (многоканальный)

Факс: 8 (812) 320-02-42

Электронная почта: org@eplast1.ru

Адрес: 198099, г. Санкт-Петербург, ул. Калинина, дом 2, корпус 4, литера А.