



## Features

- Metal shaft and bushing
- Consistent, smooth quality feel
- Up to 4 sections available
- Rotary switch option designed for “on-off” function control
- RoHS compliant\*

**81/82 - 5/8 " Square Single-Turn Panel Control**

**85/86 - 5/8 " Square Single-Turn Panel Control with Rotary Switch**

## Potentiometer Specifications

Initial Electrical Characteristics <sup>1</sup>	Conductive Plastic Element	Cermet Element
Standard Resistance Range		
Linear Tapers (A, B, E, & H) .....	(B & E) 1 K ohms to 1 megohm .....	(A & H) 100 ohms to 1 megohm
Audio Tapers (C, D, F, G, S, & T) .....	(D, G, S, & T) 1 K ohms to 1 megohm ..	(C & F) 1 K ohms to 1 megohm
Total Resistance Tolerance .....	±20 % or 10 % .....	±10 % or 5 %
Independent Linearity .....	±5 % .....	±5 %
Absolute Minimum Resistance .....	2 ohms maximum .....	2 ohms maximum
Effective Electrical Angle .....	(Linear tapers) 240 ° ± 5 ° .....	(Linear tapers) 240 ° ± 6 °
	(Audio tapers) 225 ° ± 5 ° .....	(Audio tapers) 225 ° ± 6 °
Contact Resistance Variation .....	±1 % .....	±1 % or 3 ohms (whichever is greater)
Dielectric Withstanding Voltage (MIL-STD-202, Method 301)		
Sea Level .....	1,500 VAC minimum .....	1,500 VAC minimum
70,000 Feet .....	500 VAC minimum .....	500 VAC minimum
Insulation Resistance (500 VDC) .....	1,000 megohms minimum .....	1,000 megohms minimum
Power Rating At 70 °C (Voltage Limited By Power Dissipation or 350 VAC, Whichever Is Less)		
+70 °C Single Section Assembly .....	(Linear tapers) 1 watt .....	(Linear tapers) 2 watts
	(Audio tapers) 0.5 watt .....	(Audio tapers) 1 watt
+70 °C Multiple Section Assembly .....	(Linear tapers) 0.5 watt/section .....	(Linear tapers) 1 watt/section
	(Audio tapers) 0.25 watt/section .....	(Audio tapers) 0.5 watt/section
+125 °C .....	0 watt .....	0 watt
Theoretical Resolution .....	Essentially infinite .....	Essentially infinite

## Environmental Characteristics<sup>1</sup>

Operating Temperature Range .....	-40 °C to +125 °C .....	-40 °C to +125 °C
Storage Temperature Range .....	-55 °C to +125 °C .....	-55 °C to +125 °C
Temperature Coefficient Over Storage Temperature Range .....	±1,000 ppm/°C .....	±150 ppm/°C
Vibration (Single Section) .....	15 G .....	15 G
Total Resistance Shift .....	±2 % maximum .....	±2 % maximum
Voltage Ratio Shift .....	±5 % maximum .....	±5 % maximum
Shock (Single Section) .....	30 G .....	30 G
Total Resistance Shift .....	±2 % maximum .....	±2 % maximum
Voltage Ratio Shift .....	±5 % maximum .....	±5 % maximum
Load Life .....	1,000 hours .....	1,000 hours
Total Resistance Shift .....	±10 % maximum .....	±5 % maximum
Rotational Life (No Load) .....	100,000 cycles .....	100,000 cycles
Total Resistance Shift .....	(Linear taper) 10 ohms or .....	(All tapers) ±5 % TRS maximum
	±10 % TRS max. (whichever is greater)	
	(Audio taper) ±20 % maximum	
Contact Resistance Variation @ 50,000 cycles		
(Audio taper) .....	±3 % .....	±3 %
(Linear taper) .....	±2 % .....	±2 %
Moisture Resistance (MIL-STD-202, Method 103, Condition B)		
Total Resistance Shift .....	(B & E tapers) ±10 % maximum .....	±5 % maximum (all tapers)
	(D, G, S & T tapers) ±20 % maximum	
Insulation Resistance (500 VDC) .....	100 megohms minimum .....	100 megohms minimum
IP Rating .....	IP40 .....	IP40

## Mechanical Characteristics

Stop Strength		
1/4 " and 1/8 " diameter shafts .....		45,19 N-cm (4 lb.-in.)
7/8 " length shaft .....		22.6 N-cm (2 lb.-in.)
Mechanical Angle .....		300 ° ±5 °
Torque		
Starting and Running Torque (Non-Locking Bushings)		
Single Section .....	0.14 to 1.06 N-cm (0.2 to 1.5 oz.-in.)	
Dual Section .....	0.14 to 1.06 N-cm (0.2 to 1.5 oz.-in.)	
Triple Section .....	0.35 to 1.41 N-cm (0.5 to 2.0 oz.-in.)	
Quadruple Section .....	0.35 to 1.41 N-cm (0.5 to 2.0 oz.-in.)	
Starting and Running Torque (Locking Bushings) .....	0.14 to 2.82 N-cm (0.2 to 4.0 oz.-in.)	
Shaft Locking Torque with Locknut @ 10 in.-lb. (B & E Bushings) .....	14 N-cm (20 oz.-in.)	
Mounting .....	1.7-2.0 N-m (15-18 lb.-in.) maximum	
Weight (Single Section) .....		21 grams maximum
(Each Additional Section) .....		6 grams maximum
Terminals .....		Printed circuit terminals or J-Hooks
Soldering Condition .....	Recommended hand soldering using Sn95/Ag5 no clean solder, 0.025 " wire diameter. Maximum temperature 399 °C (750 °F) for 3 seconds. No wash process to be used with no clean flux.	
Marking .....	Manufacturer's trademark, wiring diagram, date code and resistance, manufacturer's part number	
Ganging (multiple section potentiometers) .....		4 cup maximum
Hardware .....	One lockwasher and one mounting nut is shipped with each potentiometer, except where noted in the part number.	

For dimensional drawings see pages 3 & 4.

For ordering information see page 5.

NOTE: Model 81/82 performance specifications do not apply to units subjected to printed circuit board cleaning procedures.

<sup>1</sup>At room ambient: +25 °C nominal and 50 % relative humidity nominal, except as noted.

\*RoHS Directive 2002/95/EC Jan. 27, 2003 including annex and RoHS Recast 2011/65/EU June 8, 2011.

Specifications are subject to change without notice.

The device characteristics and parameters in this data sheet can and do vary in different applications and actual device performance may vary over time. Users should verify actual device performance in their specific applications.

**81/82 - 5/8 " Square Single-Turn Panel Control**  
**85/86 - 5/8 " Square Single-Turn Panel Control with Rotary Switch**



**Rotary Switch Specifications**

**Initial Electrical Characteristics<sup>1</sup>**

Contacts:	N.O./N.O., N.C./N.C. or N.O./N.C.
DPST	2 N.O./N.C. (break before make)
DPDT	
Power Rating (Resistive Load):	
DPST	2 A @ 125 volts RMS-60 Hz or 2 A @ 28 VDC, 1 A @ 250 volts RMS-60 Hz
DPDT	1 A @ 125 volts RMS-60 Hz or 1 A @ 28 VDC
Contact Resistance (0.1 VDC-10 mA)	10 milliohms nominal
Contact Bounce	5 milliseconds maximum
Dielectric Withstanding Voltage (MIL-STD-202, Method 301)	
Sea Level	1500 VAC minimum
Insulation Resistance	1000 megohms minimum

**Environmental Characteristics<sup>1</sup>**

Operating Temperature Range	-40 °C to +70 °C
Storage Temperature Range	-65 °C to +125 °C
Vibration (Dual Section)	8 G
(Triple Section)	5 G
(Quadruple Section)	3 G
Contact Resistance	10 milliohms maximum
Contact Bounce	0.1 millisecond maximum
Shock (Dual Section)	20 G
(Triple Section)	15 G
(Quadruple Section)	10 G
Contact Resistance	10 milliohms maximum
Contact Bounce	0.1 millisecond maximum
Rotational Life	25,000 cycles
Switch Actuating Torque (50% Duty cycle @ Rated Power Load)	1.41 to 4.94 N-cm (2 to 7 oz.-in.)
Contact Resistance	100 milliohms maximum
Moisture Resistance (MIL-STD-202, Method 106, Condition B)	
Contact Resistance (0.1 VDC-10 mA)	10 milliohms maximum
Insulation Resistance (After 24 Hours @ Room Temperature) (500 VDC)	100 megohms minimum
Switch Housing Material	High temperature, flame retardant, thermosetting plastic

**Mechanical Characteristics<sup>1</sup>**

Actuating Torque (Each Section, Switch Module Only)	3.53 to 10.6 N-cm (5 to 15 oz.-in.)
Running Torque (Out of Detent, 2-4 Module Assembly)	0.21 to 1.41 N-cm (0.3 to 2 oz.-in.)
Detent	CW or CCW standard
Actuation Angle	25 °
Contact Materials	Fine silver with gold overlay
Terminal Styles	Solder lug only
Standard Orientation	In-line with control terminals
Optional	Rotated 90 ° CCW from standard
Terminal Strength (Before and After Soldering Heat Exposure)	0.9 Kg (2 lbs.) minimum

NOTE: Model 81/82 performance specifications do not apply to units subjected to printed circuit board cleaning procedures.

<sup>1</sup>At room ambient: +25 °C nominal and 50 % relative humidity nominal, except as noted.

Specifications are subject to change without notice.

The device characteristics and parameters in this data sheet can and do vary in different applications and actual device performance may vary over time. Users should verify actual device performance in their specific applications.

# 81/82 - 5/8 " Square Single-Turn Panel Control

# BOURNS®

## Product Dimensions

**"A" Bushing**  
3/8 " (9.53 mm) Dia. Plain - Single Shaft



**"B" Bushing**  
3/8 " (9.53 mm) Dia. Plain - Single Shaft

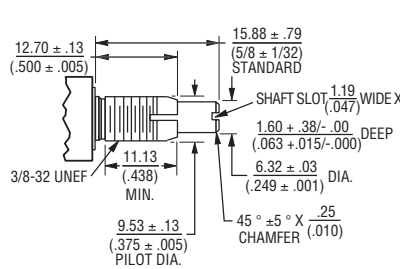

**"C" Bushing**  
1/4 " (6.35 mm) Dia. Plain - Single Shaft

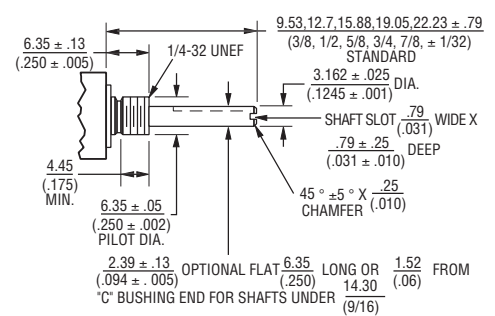

**"E" Bushing**  
1/4 " (6.35 mm) Dia. Locking - Single Shaft

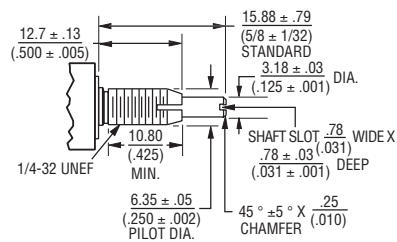

**"A" Bushing**  
3/8 " (9.53 mm) Dia. Plain - Concentric Shaft

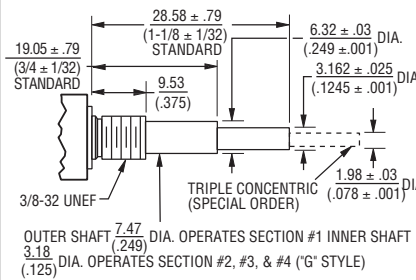

**"C" Bushing**  
1/4 " (6.35 mm) Dia. Plain - Concentric Shaft

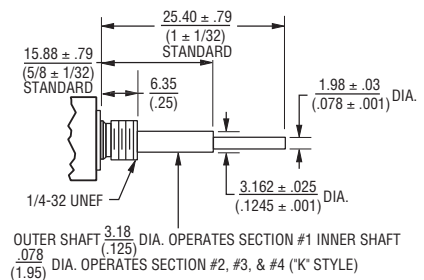

**"S" Bushing**  
10 mm Dia. Locking - Single Shaft



DIMENSIONS:  $\frac{\text{MM}}{\text{(INCHES)}}$



Specifications are subject to change without notice. The device characteristics and parameters in this data sheet can and do vary in different applications and actual device performance may vary over time. Users should verify actual device performance in their specific applications.

# 81/82 - 5/8" Square Single-Turn Panel Control

**BOURNS®**

## Product Dimensions

**Dual Unit - PC Pins & J-Hook**

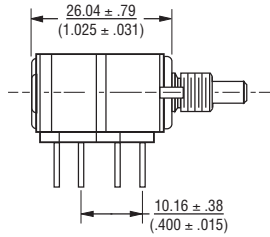

**Triple Unit - PC Pins & J-Hook**

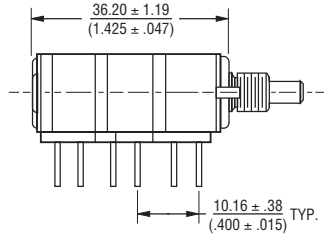

**Quad Unit - PC Pins & J-Hook**

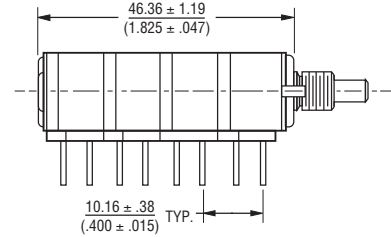

**Model 81/82  
Single Unit - PC Pins & J-Hook**



Terminal outlines shown as solid lines represent PC Pins, available on Model 81. Dashed line terminal outline represents "J" Hook, available on Model 82.

**Model 81  
Suggested PC Board Layout - PC Pins  
(Single-Shaft Style Bottom View)**

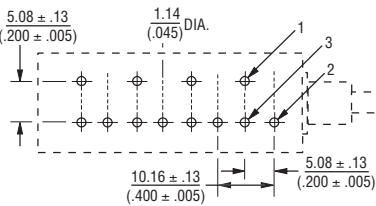

Note: For units with dual concentric shaft styles, a 2.54 (.100) spacer is added between the module(s) driven by the outer shaft and those driven by the inner shaft. For G, K, or V shafts, add the spacer between modules 1 and 2. For L or M shafts, add the spacer between modules 2 and 3. For N or P shafts, add the spacer between modules 3 and 4.

**Shaft Flat Orientation\***

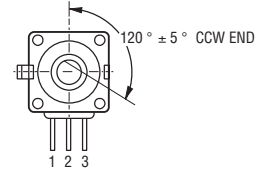

**FLATTED SHAFT**

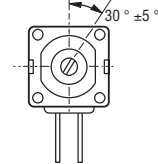

**SLOTTED SHAFT**

\*EXCLUDES MODELS 83 AND 84

DIMENSIONS:  $\frac{\text{MM}}{\text{(INCHES)}}$

Specifications are subject to change without notice.

The device characteristics and parameters in this data sheet can and do vary in different applications and actual device performance may vary over time. Users should verify actual device performance in their specific applications.

# 85/86 - 5/8" Square Single-Turn Panel Control with Rotary Switch

# BOURNS®

## Product Dimensions

### Primary Potentiometer Module Model 85/86



### Secondary Potentiometer Module Model 85/86

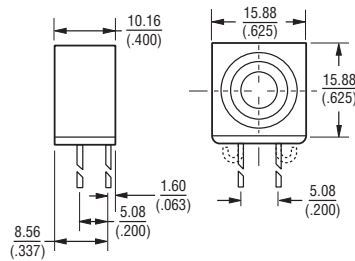

### Shaft Flat Orientation\*



### Switch Module Model 85/86



### Assembly Sequence Model 85/86 Secondary Potentiometer Module

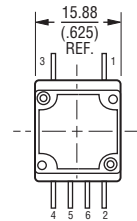

NOTE: Switch terminals shown in vertical position.



Switch contacts shown in detent position.

### Locating Lug Options - All Model 80 Series



$$E = \frac{2.36 \pm .76}{(.093 \pm .03)} \quad H \& J = \frac{1.98 \pm .41}{(.078 \pm .016)}$$



DIMENSIONS:  $\frac{\text{MM}}{\text{(INCHES)}}$

TOLERANCES EXCEPT AS SHOWN: DECIMAL .XXX ±  $\frac{.127}{(.005)}$   
 .XX ±  $\frac{.38}{(.015)}$   
 ANGLE ± 5%

NOTE: "D" OPTION - NO A/R LUG. OTHER LOCATING LUG OPTIONS AVAILABLE. FOR DETAILS CONSULT FACTORY.

# 81/82 - 5/8" Square Single-Turn Panel Control 85/86 - 5/8" Square Single-Turn Panel Control with Rotary Switch

# BOURNS®

## How To Order

81	A	2	A	-	B	28	-	A	15
85	A	2	A	-	B	28	-	A	15

A15	L
R51	L

Models 81 & 82: Part number for multiple section potentiometers must have a taper and resistance value for each section.

Models 85 & 86: Part number must contain a switch type.

ANTI-ROTATION LUG	
A	Single .305 R, 90 °CW
B	Double .305 R, 90 ° & 270 °CW
C	Single .305 R, 270 °CW
D	No Lug
E	Single .531 R, 90 °CW
F	Single .305 R, 180 °CW
J	Single .375 R, 90 °CW
K	Double .375 R, 90 ° & 270 °CW

RoHS IDENTIFIER	
L	Compliant

# SECTIONS	APPLICABLE MODELS
1	Single 81,82
2	Double 81,82,85,86
3	Triple 81,82,85,86
4	Quad 81,82,85,86

BUSHING	
A	Plain 3/8" (9.53 mm) D x 3/8" (9.53 mm) L
B	Locking 3/8" (9.53 mm) D x 1/2" (12.7 mm) L
C	Plain 1/4" (6.35 mm) D x 1/4" (6.35 mm) L
E	Locking 1/4" (6.35 mm) D x 1/2" (12.7 mm) L
J	Plain 3/8" (9.53 mm) D x 1/4" (6.35 mm) L
N	Plain 1/4" (6.35 mm) D x 3/8" (9.53 mm) L
R	Plain 10 mm D x 9 mm L
S	Locking 10 mm D x 12.5 mm L
U	Plain 7 mm D x 6 mm L

MODEL	
81	Single-Turn, PC Pins
82	Single-Turn, J-Hooks
85	Single-Turn, Pot/Rotary Switch, PC Pins
86	Single-Turn, Pot/Rotary Switch, J-Hooks

SHAFT LENGTH (FMS)		AVAILABLE ONLY IN BUSHING CODE
Code	Description	Code
12	3/8" L	C, N, J
16	1/2" L	A, C, J, N
20	5/8" L	A, B, C, E, J, N
24	3/4" L	A, B, C, E, J, N
28	7/8" L	A, B, C, E, J, N
32	1" L	A, B, C, E, J, N
36	1-1/8" L	A, B, C, E, J, N
40	1-1/4" L	A, B, C, E, J, N
Metric		
10	10 mm L	U
13	13 mm L	U
16	16 mm L	R, S
19	19 mm L	R, S
22	22 mm L	R, S, U
30	30 mm L	R, S
42	42 mm L	R, S
50	50 mm L	R, S

SWITCH TYPE (MODELS 85 & 86 ONLY)	
(R50)	DPST N.O./N.C. CW Detent In-Line Term
(R51)	DPST N.O./N.C. CCW Detent In-Line Term
(R52)	DPST N.O./N.O. CW Detent In-Line Term
(R53)	DPST N.O./N.O. CCW Detent In-Line Term
(R56)	DPST N.O./N.C. CW Detent Horz Term
(R57)	DPST N.O./N.C. CCW Detent Horz Term
(R58)	DPST N.O./N.O. CW Detent Horz Term
(R59)	DPST N.O./N.O. CCW Detent Horz Term

ELEMENT TAPER TYPE/TOLERANCE		RESISTANCE CODE VALUE IN OHMS	
(A) (H)	Linear Cermet ±10 %	(05) - 100	(30) - 15 K
	Linear Cermet ±5 %	(28) - 150	(16) - 20 K
(B) (E)	Linear C-P ±20 % Linear C-P ±10 %	(06) - 200	(17) - 25 K
		(07) - 250	(18) - 50 K
		(08) - 500	(19) - 75 K
		(09) - 750	(20) - 100 K
		(10) - 1 K	(31) - 150 K
		(29) - 1.5 K	(21) - 200 K
		(11) - 2 K	(22) - 250 K
		(12) - 2.5 K	(23) - 500 K
		(13) - 5 K	(24) - 750 K
		(14) - 7.5 K	(25) - 1 M
(15) - 10 K	(17) - 25 K		
(C)	CW Audio Cermet ±10 %	(10) - 1 K	(18) - 50 K
(D)	CW Audio C-P ±20 %	(12) - 2.5 K	(20) - 100 K
(F)	CCW Audio Cermet ±10 %	(22) - 250 K	(23) - 500 K
(G)	CCW Audio C-P ±20 %	(15) - 10 K	(25) - 1 M
(S)	CW Audio C-P ±10 %	(16) - 20 K	(21) - 200 K
(T)	CCW Audio C-P ±10 %	(17) - 25 K	(22) - 250 K

SHAFT TYPE		AVAILABLE ONLY IN	
		LENGTHS (CODE)	BUSHINGS (CODE)
A	Single Plain 1/4" (6.35 mm) D	16,20,24,28	A, B, J
B	Single Slotted 1/4" (6.35 mm) D	16,20,24,28	A, B, J
C	Single Flatted 1/4" (6.35 mm) D	20,24,28	A, B, J
E	Single Slotted 1/8" (3.18 mm) D	12,16,20,24,28	C, E, N
F	Single Flatted 1/8" (3.18 mm) D	24	C, N
G	Dual Concentric Plain 1/4" (6.35 mm) D - 1/8" (3.18 mm) D Outer Operates Section 1	36,40	A, J
K	Dual Concentric Plain 1/8" (3.18 mm) D - 5/64" (1.98 mm) D Outer Operates Section 1	32,36	C, N
L	Dual Concentric Plain 1/4" (6.35 mm) D - 1/8" (3.18 mm) D Outer Operates Section 1/2	36,40	A, J
M	Dual Concentric Plain 1/8" (3.18 mm) D - 5/64" (1.98 mm) D Outer Operates Section 1/2	32,36	C, N
N	Dual Concentric Plain 1/4" (6.35 mm) D - 1/8" (3.18 mm) D Outer Operates Section 1/2/3	36,40	A, J
P	Dual Concentric Plain 1/8" (3.18 mm) D - 5/64" (1.98 mm) D Outer Operates Section 1/2/3	32,36	C, N
R	Single Slotted 6 mm D	16,19,22,50	R, S
T	Single Slotted 4 mm D	10, 13, 22	U
V	Dual Concentric Plain 6 mm D - 3 mm D Outer Operates Section 1	30, 42	R

*Boldface features are Bourns standard options. All others are available with higher minimum order quantities.*

REV. 03/13

Specifications are subject to change without notice.

The device characteristics and parameters in this data sheet can and do vary in different applications and actual device performance may vary over time.

Users should verify actual device performance in their specific applications.



Компания «ЭлектроПласт» предлагает заключение долгосрочных отношений при поставках импортных электронных компонентов на взаимовыгодных условиях!

Наши преимущества:

- Оперативные поставки широкого спектра электронных компонентов отечественного и импортного производства напрямую от производителей и с крупнейших мировых складов;
- Поставка более 17-ти миллионов наименований электронных компонентов;
- Поставка сложных, дефицитных, либо снятых с производства позиций;
- Оперативные сроки поставки под заказ (от 5 рабочих дней);
- Экспресс доставка в любую точку России;
- Техническая поддержка проекта, помощь в подборе аналогов, поставка прототипов;
- Система менеджмента качества сертифицирована по Международному стандарту ISO 9001;
- Лицензия ФСБ на осуществление работ с использованием сведений, составляющих государственную тайну;
- Поставка специализированных компонентов (Xilinx, Altera, Analog Devices, Intersil, Interpoint, Microsemi, Aeroflex, Peregrine, Syfer, Eurofarad, Texas Instrument, Miteq, Cobham, E2V, MA-COM, Hittite, Mini-Circuits, General Dynamics и др.);

Помимо этого, одним из направлений компании «ЭлектроПласт» является направление «Источники питания». Мы предлагаем Вам помощь Конструкторского отдела:

- Подбор оптимального решения, техническое обоснование при выборе компонента;
- Подбор аналогов;
- Консультации по применению компонента;
- Поставка образцов и прототипов;
- Техническая поддержка проекта;
- Защита от снятия компонента с производства.



#### Как с нами связаться

**Телефон:** 8 (812) 309 58 32 (многоканальный)

**Факс:** 8 (812) 320-02-42

**Электронная почта:** [org@eplast1.ru](mailto:org@eplast1.ru)

**Адрес:** 198099, г. Санкт-Петербург, ул. Калинина, дом 2, корпус 4, литера А.