



Features

- Metal shaft and bushing
- Consistent, smooth quality feel
- Up to 4 sections available
- Rotary switch option designed for “on-off” function control
- RoHS compliant*

81/82 - 5/8" Square Single-Turn Panel Control

85/86 - 5/8" Square Single-Turn Panel Control with Rotary Switch

Potentiometer Specifications

| Initial Electrical Characteristics ¹ | Conductive Plastic Element | Cermet Element |
|--|--|---------------------------------------|
| Standard Resistance Range | | |
| Linear Tapers (A, B, E, & H) | (B & E) 1 K ohms to 1 megohm | (A & H) 100 ohms to 1 megohm |
| Audio Tapers (C, D, F, G, S, & T) | (D, G, S, & T) 1 K ohms to 1 megohm .. | (C & F) 1 K ohms to 1 megohm |
| Total Resistance Tolerance | ±20 % or 10 % | ±10 % or 5 % |
| Independent Linearity | ±5 % | ±5 % |
| Absolute Minimum Resistance | 2 ohms maximum | 2 ohms maximum |
| Effective Electrical Angle | (Linear tapers) 240 ° ± 5 ° | (Linear tapers) 240 ° ± 6 ° |
| | (Audio tapers) 225 ° ± 5 ° | (Audio tapers) 225 ° ± 6 ° |
| Contact Resistance Variation | ±1 % | ±1 % or 3 ohms (whichever is greater) |
| Dielectric Withstanding Voltage (MIL-STD-202, Method 301) | | |
| Sea Level | 1,500 VAC minimum | 1,500 VAC minimum |
| 70,000 Feet | 500 VAC minimum | 500 VAC minimum |
| Insulation Resistance (500 VDC) | 1,000 megohms minimum | 1,000 megohms minimum |
| Power Rating At 70 °C (Voltage Limited By Power Dissipation or 350 VAC, Whichever Is Less) | | |
| +70 °C Single Section Assembly | (Linear tapers) 1 watt | (Linear tapers) 2 watts |
| | (Audio tapers) 0.5 watt | (Audio tapers) 1 watt |
| +70 °C Multiple Section Assembly | (Linear tapers) 0.5 watt/section | (Linear tapers) 1 watt/section |
| | (Audio tapers) 0.25 watt/section | (Audio tapers) 0.5 watt/section |
| +125 °C | 0 watt | 0 watt |
| Theoretical Resolution | Essentially infinite | Essentially infinite |

Environmental Characteristics¹

| | | |
|--|---------------------------------------|-------------------------------|
| Operating Temperature Range | -40 °C to +125 °C | -40 °C to +125 °C |
| Storage Temperature Range | -55 °C to +125 °C | -55 °C to +125 °C |
| Temperature Coefficient Over Storage Temperature Range | ±1,000 ppm/°C | ±150 ppm/°C |
| Vibration (Single Section) | 15 G | 15 G |
| Total Resistance Shift | ±2 % maximum | ±2 % maximum |
| Voltage Ratio Shift | ±5 % maximum | ±5 % maximum |
| Shock (Single Section) | 30 G | 30 G |
| Total Resistance Shift | ±2 % maximum | ±2 % maximum |
| Voltage Ratio Shift | ±5 % maximum | ±5 % maximum |
| Load Life | 1,000 hours | 1,000 hours |
| Total Resistance Shift | ±10 % maximum | ±5 % maximum |
| Rotational Life (No Load) | 100,000 cycles | 100,000 cycles |
| Total Resistance Shift | (Linear taper) 10 ohms or | (All tapers) ±5 % TRS maximum |
| | ±10 % TRS max. (whichever is greater) | |
| | (Audio taper) ±20 % maximum | |
| Contact Resistance Variation @ 50,000 cycles | | |
| (Audio taper) | ±3 % | ±3 % |
| (Linear taper) | ±2 % | ±2 % |
| Moisture Resistance (MIL-STD-202, Method 103, Condition B) | | |
| Total Resistance Shift | (B & E tapers) ±10 % maximum | ±5 % maximum (all tapers) |
| | (D, G, S & T tapers) ±20 % maximum | |
| Insulation Resistance (500 VDC) | 100 megohms minimum | 100 megohms minimum |
| IP Rating | IP40 | IP40 |

Mechanical Characteristics

| | | |
|---|--|--------------------------------------|
| Stop Strength | | |
| 1/4" and 1/8" diameter shafts | | 45,19 N-cm (4 lb.-in.) |
| 7/8" length shaft | | 22.6 N-cm (2 lb.-in.) |
| Mechanical Angle | | 300 ° ±5 ° |
| Torque | | |
| Starting and Running Torque (Non-Locking Bushings) | | |
| Single Section | 0.14 to 1.06 N-cm (0.2 to 1.5 oz.-in.) | |
| Dual Section | 0.14 to 1.06 N-cm (0.2 to 1.5 oz.-in.) | |
| Triple Section | 0.35 to 1.41 N-cm (0.5 to 2.0 oz.-in.) | |
| Quadruple Section | 0.35 to 1.41 N-cm (0.5 to 2.0 oz.-in.) | |
| Starting and Running Torque (Locking Bushings) | 0.14 to 2.82 N-cm (0.2 to 4.0 oz.-in.) | |
| Shaft Locking Torque with Locknut @ 10 in.-lb. (B & E Bushings) | 14 N-cm (20 oz.-in.) | |
| Mounting | 1.7-2.0 N-m (15-18 lb.-in.) maximum | |
| Weight (Single Section) | | 21 grams maximum |
| (Each Additional Section) | | 6 grams maximum |
| Terminals | | Printed circuit terminals or J-Hooks |
| Soldering Condition | Recommended hand soldering using Sn95/Ag5 no clean solder, 0.025" wire diameter. Maximum temperature 399 °C (750 °F) for 3 seconds. No wash process to be used with no clean flux. | |
| Marking | Manufacturer's trademark, wiring diagram, date code and resistance, manufacturer's part number | |
| Ganging (multiple section potentiometers) | | 4 cup maximum |
| Hardware | One lockwasher and one mounting nut is shipped with each potentiometer, except where noted in the part number. | |

For dimensional drawings see pages 3 & 4.

For ordering information see page 5.

NOTE: Model 81/82 performance specifications do not apply to units subjected to printed circuit board cleaning procedures.

¹At room ambient: +25 °C nominal and 50 % relative humidity nominal, except as noted.

*RoHS Directive 2002/95/EC Jan. 27, 2003 including annex and RoHS Recast 2011/65/EU June 8, 2011.

Specifications are subject to change without notice.

The device characteristics and parameters in this data sheet can and do vary in different applications and actual device performance may vary over time. Users should verify actual device performance in their specific applications.

81/82 - 5/8 " Square Single-Turn Panel Control
85/86 - 5/8 " Square Single-Turn Panel Control with Rotary Switch

BOURNS®

Rotary Switch Specifications

Initial Electrical Characteristics¹

| | |
|---|--|
| Contacts: | N.O./N.O., N.C./N.C. or N.O./N.C. |
| DPST | 2 N.O./N.C. (break before make) |
| DPDT | |
| Power Rating (Resistive Load): | |
| DPST | 2 A @ 125 volts RMS-60 Hz or 2 A @ 28 VDC, 1 A @ 250 volts RMS-60 Hz |
| DPDT | 1 A @ 125 volts RMS-60 Hz or 1 A @ 28 VDC |
| Contact Resistance (0.1 VDC-10 mA) | 10 milliohms nominal |
| Contact Bounce | 5 milliseconds maximum |
| Dielectric Withstanding Voltage (MIL-STD-202, Method 301) | |
| Sea Level | 1500 VAC minimum |
| Insulation Resistance | 1000 megohms minimum |

Environmental Characteristics¹

| | |
|---|--|
| Operating Temperature Range | -40 °C to +70 °C |
| Storage Temperature Range | -65 °C to +125 °C |
| Vibration (Dual Section) | 8 G |
| (Triple Section) | 5 G |
| (Quadruple Section) | 3 G |
| Contact Resistance | 10 milliohms maximum |
| Contact Bounce | 0.1 millisecond maximum |
| Shock (Dual Section) | 20 G |
| (Triple Section) | 15 G |
| (Quadruple Section) | 10 G |
| Contact Resistance | 10 milliohms maximum |
| Contact Bounce | 0.1 millisecond maximum |
| Rotational Life | 25,000 cycles |
| Switch Actuating Torque (50% Duty cycle @ Rated Power Load) | 1.41 to 4.94 N-cm (2 to 7 oz.-in.) |
| Contact Resistance | 100 milliohms maximum |
| Moisture Resistance (MIL-STD-202, Method 106, Condition B) | |
| Contact Resistance (0.1 VDC-10 mA) | 10 milliohms maximum |
| Insulation Resistance (After 24 Hours @ Room Temperature) (500 VDC) | 100 megohms minimum |
| Switch Housing Material | High temperature, flame retardant, thermosetting plastic |

Mechanical Characteristics¹

| | |
|--|--------------------------------------|
| Actuating Torque (Each Section, Switch Module Only) | 3.53 to 10.6 N-cm (5 to 15 oz.-in.) |
| Running Torque (Out of Detent, 2-4 Module Assembly) | 0.21 to 1.41 N-cm (0.3 to 2 oz.-in.) |
| Detent | CW or CCW standard |
| Actuation Angle | 25 ° |
| Contact Materials | Fine silver with gold overlay |
| Terminal Styles | Solder lug only |
| Standard Orientation | In-line with control terminals |
| Optional | Rotated 90 ° CCW from standard |
| Terminal Strength (Before and After Soldering Heat Exposure) | 0.9 Kg (2 lbs.) minimum |

NOTE: Model 81/82 performance specifications do not apply to units subjected to printed circuit board cleaning procedures.

¹At room ambient: +25 °C nominal and 50 % relative humidity nominal, except as noted.

Specifications are subject to change without notice.

The device characteristics and parameters in this data sheet can and do vary in different applications and actual device performance may vary over time. Users should verify actual device performance in their specific applications.

81/82 - 5/8 " Square Single-Turn Panel Control

BOURNS®

Product Dimensions

"A" Bushing
3/8 " (9.53 mm) Dia. Plain - Single Shaft

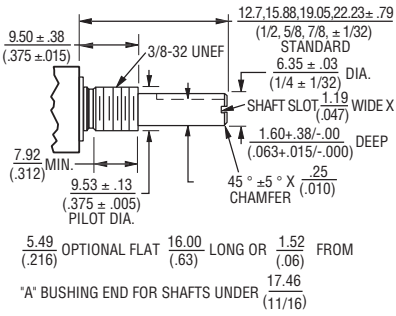

"B" Bushing
3/8 " (9.53 mm) Dia. Plain - Single Shaft

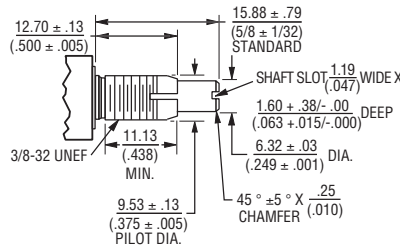

"C" Bushing
1/4 " (6.35 mm) Dia. Plain - Single Shaft

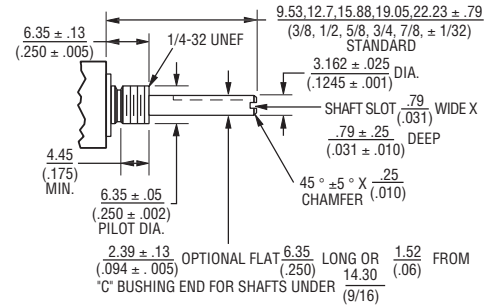

"E" Bushing
1/4 " (6.35 mm) Dia. Locking - Single Shaft

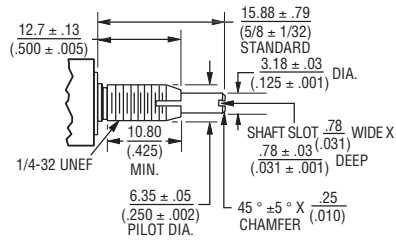

"A" Bushing
3/8 " (9.53 mm) Dia. Plain - Concentric Shaft

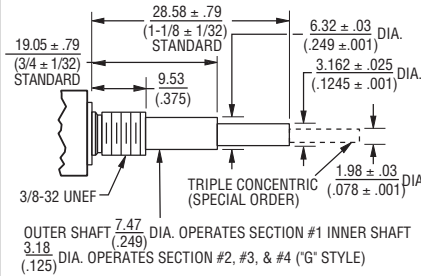

"C" Bushing
1/4 " (6.35 mm) Dia. Plain - Concentric Shaft

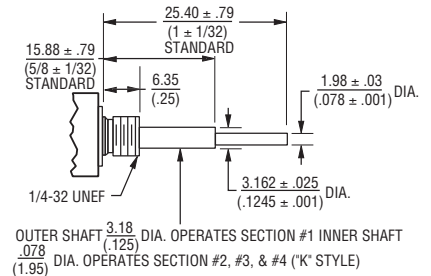

"S" Bushing
10 mm Dia. Locking - Single Shaft

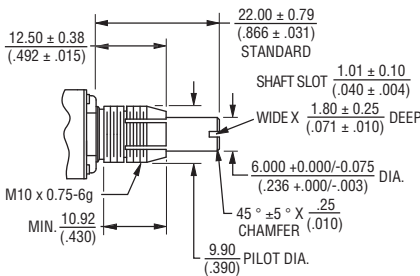

DIMENSIONS: $\frac{\text{MM}}{\text{(INCHES)}}$

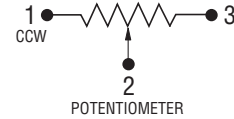

81/82 - 5/8" Square Single-Turn Panel Control

BOURNS®

Product Dimensions

Dual Unit - PC Pins & J-Hook



Triple Unit - PC Pins & J-Hook



Quad Unit - PC Pins & J-Hook



**Model 81/82
Single Unit - PC Pins & J-Hook**



Terminal outlines shown as solid lines represent PC Pins, available on Model 81. Dashed line terminal outline represents "J" Hook, available on Model 82.

**Model 81
Suggested PC Board Layout - PC Pins
(Single-Shaft Style Bottom View)**



Note: For units with dual concentric shaft styles, a 2.54 (.100) spacer is added between the module(s) driven by the outer shaft and those driven by the inner shaft. For G, K, or V shafts, add the spacer between modules 1 and 2. For L or M shafts, add the spacer between modules 2 and 3. For N or P shafts, add the spacer between modules 3 and 4.

Shaft Flat Orientation*



FLATTED SHAFT



SLOTTED SHAFT

*EXCLUDES MODELS 83 AND 84

DIMENSIONS: $\frac{\text{MM}}{\text{(INCHES)}}$

Specifications are subject to change without notice.

The device characteristics and parameters in this data sheet can and do vary in different applications and actual device performance may vary over time. Users should verify actual device performance in their specific applications.

85/86 - 5/8" Square Single-Turn Panel Control with Rotary Switch

BOURNS®

Product Dimensions

Primary Potentiometer Module Model 85/86



Secondary Potentiometer Module Model 85/86

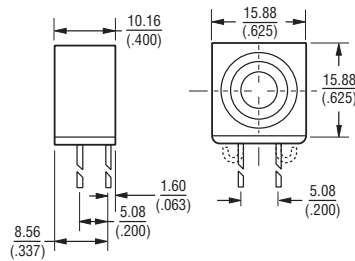

Shaft Flat Orientation*

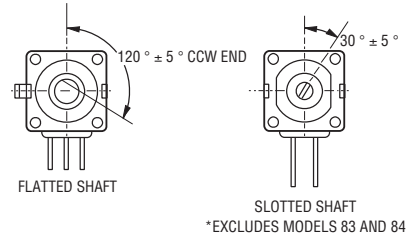

Switch Module Model 85/86

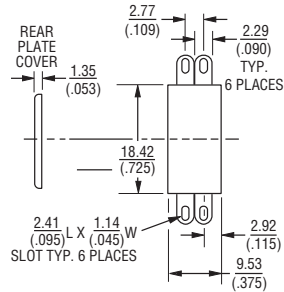

Assembly Sequence Model 85/86 Secondary Potentiometer Module

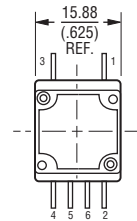
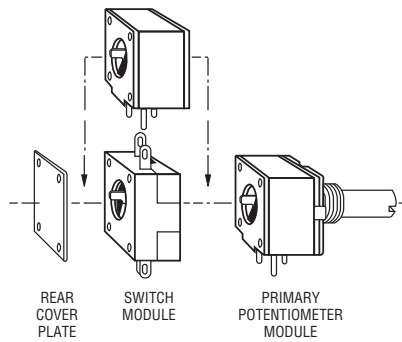

NOTE: Switch terminals shown in vertical position.



Switch contacts shown in detent position.

Locating Lug Options - All Model 80 Series

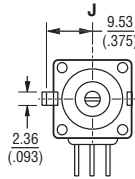
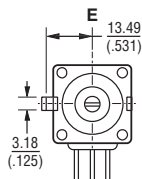
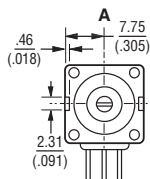

$$E = \frac{2.36 \pm .76}{(.093 \pm .03)} \quad H \& J = \frac{1.98 \pm .41}{(.078 \pm .016)}$$



DIMENSIONS: $\frac{\text{MM}}{(\text{INCHES})}$

NOTE: "D" OPTION - NO A/R LUG. OTHER LOCATING LUG OPTIONS AVAILABLE. FOR DETAILS CONSULT FACTORY.

TOLERANCES EXCEPT AS SHOWN: DECIMAL .XXX ± $\frac{.127}{(.005)}$
 .XX ± $\frac{.38}{(.015)}$
 ANGLE ± 5%

81/82 - 5/8" Square Single-Turn Panel Control 85/86 - 5/8" Square Single-Turn Panel Control with Rotary Switch

BOURNS®

How To Order

| | | | | | | | | | |
|----|---|---|---|---|---|----|---|---|----|
| 81 | A | 2 | A | - | B | 28 | - | A | 15 |
| 85 | A | 2 | A | - | B | 28 | - | A | 15 |

| | |
|-----|---|
| A15 | L |
| R51 | L |

Models 81 & 82: Part number for multiple section potentiometers must have a taper and resistance value for each section.

Models 85 & 86: Part number must contain a switch type.

| ANTI-ROTATION LUG | |
|-------------------|-------------------------------|
| A | Single .305 R, 90 °CW |
| B | Double .305 R, 90 ° & 270 °CW |
| C | Single .305 R, 270 °CW |
| D | No Lug |
| E | Single .531 R, 90 °CW |
| F | Single .305 R, 180 °CW |
| J | Single .375 R, 90 °CW |
| K | Double .375 R, 90 ° & 270 °CW |

| RoHS IDENTIFIER | |
|-----------------|-----------|
| L | Compliant |

| # SECTIONS | APPLICABLE MODELS |
|------------|--------------------|
| 1 | Single 81,82 |
| 2 | Double 81,82,85,86 |
| 3 | Triple 81,82,85,86 |
| 4 | Quad 81,82,85,86 |

| BUSHING | |
|---------|---|
| A | Plain 3/8" (9.53 mm) D x 3/8" (9.53 mm) L |
| B | Locking 3/8" (9.53 mm) D x 1/2" (12.7 mm) L |
| C | Plain 1/4" (6.35 mm) D x 1/4" (6.35 mm) L |
| E | Locking 1/4" (6.35 mm) D x 1/2" (12.7 mm) L |
| J | Plain 3/8" (9.53 mm) D x 1/4" (6.35 mm) L |
| N | Plain 1/4" (6.35 mm) D x 3/8" (9.53 mm) L |
| R | Plain 10 mm D x 9 mm L |
| S | Locking 10 mm D x 12.5 mm L |
| U | Plain 7 mm D x 6 mm L |

| SHAFT LENGTH (FMS) | | AVAILABLE ONLY IN BUSHING |
|--------------------|-------------|---------------------------|
| Code | Description | Code |
| 12 | 3/8" L | C, N, J |
| 16 | 1/2" L | A, C, J, N |
| 20 | 5/8" L | A, B, C, E, J, N |
| 24 | 3/4" L | A, B, C, E, J, N |
| 28 | 7/8" L | A, B, C, E, J, N |
| 32 | 1" L | A, B, C, E, J, N |
| 36 | 1-1/8" L | A, B, C, E, J, N |
| 40 | 1-1/4" L | A, B, C, E, J, N |
| Metric | | |
| 10 | 10 mm L | U |
| 13 | 13 mm L | U |
| 16 | 16 mm L | R, S |
| 19 | 19 mm L | R, S |
| 22 | 22 mm L | R, S, U |
| 30 | 30 mm L | R, S |
| 42 | 42 mm L | R, S |
| 50 | 50 mm L | R, S |

| SWITCH TYPE (MODELS 85 & 86 ONLY) | |
|-----------------------------------|--|
| (R50) | DPST N.O./N.C. CW Detent In-Line Term |
| (R51) | DPST N.O./N.C. CCW Detent In-Line Term |
| (R52) | DPST N.O./N.O. CW Detent In-Line Term |
| (R53) | DPST N.O./N.O. CCW Detent In-Line Term |
| (R56) | DPST N.O./N.C. CW Detent Horz Term |
| (R57) | DPST N.O./N.C. CCW Detent Horz Term |
| (R58) | DPST N.O./N.O. CW Detent Horz Term |
| (R59) | DPST N.O./N.O. CCW Detent Horz Term |

| MODEL | |
|-------|---|
| 81 | Single-Turn, PC Pins |
| 82 | Single-Turn, J-Hooks |
| 85 | Single-Turn, Pot/Rotary Switch, PC Pins |
| 86 | Single-Turn, Pot/Rotary Switch, J-Hooks |

| ELEMENT TAPER TYPE/TOLERANCE | | RESISTANCE CODE VALUE IN OHMS | |
|--|--|-------------------------------|---------------------|
| (A) (H) | Linear Cermet ±10 % Linear Cermet ±5 % | (05) - 100 | (30) - 15 K |
| | | (28) - 150 | (16) - 20 K |
| | | (06) - 200 | (17) - 25 K |
| | | (07) - 250 | (18) - 50 K |
| | | (08) - 500 | (19) - 75 K |
| | | (09) - 750 | (20) - 100 K |
| | | (10) - 1 K | (31) - 150 K |
| | | (29) - 1.5 K | (21) - 200 K |
| | | (11) - 2 K | (22) - 250 K |
| | | (12) - 2.5 K | (23) - 500 K |
| (B) (E) | Linear C-P ±20 % Linear C-P ±10 % | (10) - 1 K | (18) - 50 K |
| | | (12) - 2.5 K | (20) - 100 K |
| | | (13) - 5 K | (22) - 250 K |
| | | (15) - 10 K | (23) - 500 K |
| | | (16) - 20 K | (25) - 1 M |
| (C) (D) (F) (G) (S) (T) | CW Audio Cermet ±10 % CW Audio C-P ±20 % CCW Audio Cermet ±10 % CCW Audio C-P ±20 % CW Audio C-P ±10 % CCW Audio C-P ±10 % | (10) - 1 K | (18) - 50 K |
| | | (12) - 2.5 K | (20) - 100 K |
| | | (22) - 250 K | (23) - 500 K |
| | | (15) - 10 K | (25) - 1 M |
| | | (17) - 25 K | (25) - 1 M |

| SHAFT TYPE | | AVAILABLE ONLY IN | |
|------------|--|-----------------------|-----------------|
| | | LENGTHS (CODE) | BUSHINGS (CODE) |
| A | Single Plain 1/4" (6.35 mm) D | 16,20,24,28 | A, B, J |
| B | Single Slotted 1/4" (6.35 mm) D | 16,20,24,28 | A, B, J |
| C | Single Flatted 1/4" (6.35 mm) D | 20,24,28 | A, B, J |
| E | Single Slotted 1/8" (3.18 mm) D | 12,16,20,24,28 | C, E, N |
| F | Single Flatted 1/8" (3.18 mm) D | 24 | C, N |
| G | Dual Concentric Plain 1/4" (6.35 mm) D - 1/8" (3.18 mm) D Outer Operates Section 1 | 36,40 | A, J |
| K | Dual Concentric Plain 1/8" (3.18 mm) D - 5/64" (1.98 mm) D Outer Operates Section 1 | 32,36 | C, N |
| L | Dual Concentric Plain 1/4" (6.35 mm) D - 1/8" (3.18 mm) D Outer Operates Section 1/2 | 36,40 | A, J |
| M | Dual Concentric Plain 1/8" (3.18 mm) D - 5/64" (1.98 mm) D Outer Operates Section 1/2 | 32,36 | C, N |
| N | Dual Concentric Plain 1/4" (6.35 mm) D - 1/8" (3.18 mm) D Outer Operates Section 1/2/3 | 36,40 | A, J |
| P | Dual Concentric Plain 1/8" (3.18 mm) D - 5/64" (1.98 mm) D Outer Operates Section 1/2/3 | 32,36 | C, N |
| R | Single Slotted 6 mm D | 16,19,22,50 | R, S |
| T | Single Slotted 4 mm D | 10, 13, 22 | U |
| V | Dual Concentric Plain 6 mm D - 3 mm D Outer Operates Section 1 | 30, 42 | R |

Boldface features are Bourns standard options. All others are available with higher minimum order quantities.

REV. 03/13

Specifications are subject to change without notice.

The device characteristics and parameters in this data sheet can and do vary in different applications and actual device performance may vary over time.

Users should verify actual device performance in their specific applications.



Компания «ЭлектроПласт» предлагает заключение долгосрочных отношений при поставках импортных электронных компонентов на взаимовыгодных условиях!

Наши преимущества:

- Оперативные поставки широкого спектра электронных компонентов отечественного и импортного производства напрямую от производителей и с крупнейших мировых складов;
- Поставка более 17-ти миллионов наименований электронных компонентов;
- Поставка сложных, дефицитных, либо снятых с производства позиций;
- Оперативные сроки поставки под заказ (от 5 рабочих дней);
- Экспресс доставка в любую точку России;
- Техническая поддержка проекта, помощь в подборе аналогов, поставка прототипов;
- Система менеджмента качества сертифицирована по Международному стандарту ISO 9001;
- Лицензия ФСБ на осуществление работ с использованием сведений, составляющих государственную тайну;
- Поставка специализированных компонентов (Xilinx, Altera, Analog Devices, Intersil, Interpoint, Microsemi, Aeroflex, Peregrine, Syfer, Eurofarad, Texas Instrument, Miteq, Cobham, E2V, MA-COM, Hittite, Mini-Circuits, General Dynamics и др.);

Помимо этого, одним из направлений компании «ЭлектроПласт» является направление «Источники питания». Мы предлагаем Вам помощь Конструкторского отдела:

- Подбор оптимального решения, техническое обоснование при выборе компонента;
- Подбор аналогов;
- Консультации по применению компонента;
- Поставка образцов и прототипов;
- Техническая поддержка проекта;
- Защита от снятия компонента с производства.



Как с нами связаться

Телефон: 8 (812) 309 58 32 (многоканальный)

Факс: 8 (812) 320-02-42

Электронная почта: org@eplast1.ru

Адрес: 198099, г. Санкт-Петербург, ул. Калинина, дом 2, корпус 4, литера А.