

High-Voltage Types Application Guide, Transmitting Mica

Types 271, 272, 273 — Rectangular Case, High-Current and High-Voltage Circuits



Types 271, 272, 273 are designed for frequencies ranging from 100 kHz to 3 MHz and are well suited for high-current and high-voltage radio transmitter circuit applications. Cast in rectangular cases, these capacitors are electrically equivalent to MIL-C-5 Styles CM65 through CM73 in capacitance and current ratings, but are far superior in environmental capability, temperature range, physical size, mounting configuration and reliability.

Highlights

- Type 273 permits stand-off mounting
- Highly shock resistant
- Optional aluminum mounting plates
- Convenient mounting
- Cast in rectangular cases

Specifications

Capacitance Range	47 pF to 0.1 μ F
Capacitance Tolerance	\pm 5% (J)
Rated Voltage	1 to 60 kVpk
Operating Temperature Range with Ripple	-55 $^{\circ}$ C to 125 $^{\circ}$ C

Type 271 Ratings

Cap (pF)	Catalog Part Number	Maximum AC Current at 65 $^{\circ}$ C			
		3 MHz (A)	1 MHz (A)	300 kHz (A)	100 kHz (A)
250 Peak Volts					
47000	27102B473JO0	11.0	11.0	9.1	4.7
50000	27102B503JO0	11.0	11.0	9.1	4.7
51000	27102B513JO0	11.0	11.0	9.1	4.7
56000	27102B563JO0	11.0	11.0	9.1	4.7
62000	27102B623JO0	11.0	11.0	9.1	5.1
68000	27102B683JO0	11.0	11.0	9.1	5.1
75000	27102B753JO0	11.0	11.0	9.1	5.1
82000	27102B823JO0	11.0	11.0	9.1	5.1
91000	27102B913JO0	11.0	11.0	9.1	5.6
100000	27102B104JO0	11.0	11.0	9.1	5.6
500 Peak Volts					
27000	27105B273JO0	11.0	11.0	7.5	3.9
30000	27105B303JO0	11.0	11.0	8.2	3.9
33000	27105B333JO0	11.0	11.0	8.2	4.3
36000	27105B363JO0	11.0	11.0	8.2	4.3
39000	27105B393JO0	11.0	11.0	8.2	4.3
43000	27105B433JO0	11.0	11.0	9.1	4.7
1000 Peak Volts					
10000	27110B103JO0	10.0	9.1	5.1	2.4
11000	27110B113JO0	11.0	10.0	5.6	2.7
12000	27110B123JO0	11.0	10.0	6.2	3.0
13000	27110B133JO0	11.0	11.0	6.8	3.0
15000	27110B153JO0	11.0	11.0	6.8	3.3
16000	27110B163JO0	11.0	11.0	6.8	3.3
18000	27110B183JO0	11.0	11.0	7.5	3.3
20000	27110B203JO0	11.0	11.0	7.5	3.6
22000	27110B223JO0	11.0	11.0	7.5	3.6
24000	27110B243JO0	11.0	11.0	7.5	3.6

Cap (pF)	Catalog Part Number	Maximum AC Current at 65 $^{\circ}$ C			
		3 MHz (A)	1 MHz (A)	300 kHz (A)	100 kHz (A)
1500 Peak Volts					
8000	27115B802JO0	10.0	8.2	4.7	2.2
8200	27115B822JO0	10.0	8.2	4.7	2.2
9100	27115B912JO0	10.0	8.2	4.7	2.4
2700	27120B272JO0	6.8	5.1	2.7	1.3
2000 Peak Volts					
3000	27120B302JO0	7.5	5.1	3.0	1.3
3300	27120B332JO0	7.5	5.6	3.0	1.5
3600	27120B362JO0	7.5	5.6	3.3	1.5
3900	27120B392JO0	8.2	6.2	3.3	1.6
4000	27120B402JO0	8.2	6.2	3.3	1.6
4300	27120B432JO0	8.2	6.2	3.6	1.6
4700	27120B472JO0	8.2	6.8	3.6	1.8
5000	27120B502JO0	8.2	6.8	3.6	1.8
5100	27120B512JO0	8.2	6.8	3.6	1.8
5600	27120B562JO0	9.1	7.5	3.9	2.0
6000	27120B602JO0	9.1	7.5	4.3	2.0
6200	27120B622JO0	9.1	7.5	4.3	2.0
6800	27120B682JO0	10.0	7.5	4.3	2.0
7500	27120B752JO0	10.0	8.2	4.7	2.2
3000 Peak Volts					
47	27130B470JO0	1.2	0.5	0.2	0.1
51	27130B510JO0	1.3	0.5	0.2	0.1
56	27130B560JO0	1.3	0.6	0.2	0.1
62	27130B620JO0	1.5	0.6	0.2	0.1
68	27130B680JO0	1.5	0.6	0.2	0.1
75	27130B750JO0	1.5	0.6	0.3	0.1
82	27130B820JO0	1.6	0.7	0.3	0.1
91	27130B910JO0	1.6	0.7	0.3	0.1

High-Voltage Types Application Guide, Transmitting Mica

Type 271 Ratings

Maximum AC Current at 65 °C					
Cap (pF)	Catalog Part Number	3 MHz (A)	1 MHz (A)	300 kHz (A)	100 kHz (A)
3000 Peak Volts					
100	27105B273J00	11.0	11.0	7.5	3.9
110	27130B111J00	1.8	0.8	0.4	0.1
120	27130B121J00	2.0	0.9	0.4	0.2
130	27130B131J00	2.0	0.9	0.4	0.2
150	27130B151J00	2.2	1.0	0.5	0.2
160	27130B161J00	2.2	1.1	0.5	0.2
180	27130B181J00	2.4	1.1	0.6	0.2
200	27130B201J00	2.4	1.2	0.6	0.2
220	27130B221J00	2.7	1.3	0.6	0.3
240	27130B241J00	2.7	1.3	0.7	0.3
250	27130B251J00	2.7	1.3	0.7	0.3
270	27130B271J00	3.1	1.5	0.8	0.3
300	27130B301J00	3.0	1.5	0.8	0.4
330	27130B331J00	3.0	1.6	0.8	0.4
360	27130B361J00	3.3	1.6	0.9	0.4
390	27130B391J00	3.3	1.8	0.9	0.4
430	27130B431J00	3.6	1.8	1.0	0.5
470	27130B471J00	3.6	2.0	1.1	0.5
500	27130B501J00	3.6	2.0	1.1	0.5
510	27130B511J00	3.6	2.0	1.1	0.5
560	27130B561J00	3.9	2.2	1.2	0.5
620	27130B621J00	3.9	2.4	1.2	0.6
680	27130B681J00	4.3	2.4	1.3	0.6
750	27130B751J00	4.3	2.7	1.3	0.6
820	27130B821J00	4.3	2.7	1.5	0.7
910	27130B911J00	4.7	3.0	1.5	0.7
1000	27130B102J00	4.7	3.0	1.6	0.8
1100	27130B112J00	5.1	3.3	1.6	0.8
1200	27130B122J00	5.1	3.3	1.8	0.8
1300	27130B132J00	5.6	3.6	1.8	0.9
1500	27130B152J00	5.6	3.9	2.0	0.9
1600	27130B162J00	5.6	3.9	2.0	1.0
1800	27130B182J00	6.2	4.3	2.2	1.1
2000	27130B202J00	6.2	4.3	2.4	1.1
2200	27130B222J00	6.8	4.7	2.4	1.2

Type 272 Ratings

Maximum AC Current at 65 °C					
Cap (pF)	Catalog Part Number	3 MHz (A)	1 MHz (A)	300 kHz (A)	100 kHz (A)
250 Peak Volts					
250000	27202B254J00	15.0	18.0	15.0	8.2

Maximum AC Current at 65 °C					
Cap (pF)	Catalog Part Number	3 MHz (A)	1 MHz (A)	300 kHz (A)	100 kHz (A)
500 Peak Volts					
82000	27205B823J00	15.0	18.0	15.0	8.2
91000	27205B913J00	15.0	18.0	15.0	8.2
100000	27205B104J00	15.0	18.0	15.0	8.2
200000	27205B204J00	15.0	18.0	15.0	8.2
1000 Peak Volts					
56000	27210B563J00	15.0	16.0	15.0	8.2
62000	27210B623J00	15.0	18.0	15.0	8.2
68000	27210B683J00	15.0	18.0	15.0	8.2
75000	27215B333J00	15.0	18.0	15.0	8.2
1500 Peak Volts					
24000	27215B243J00	13.0	15.0	12.0	6.8
27000	27215B273J00	13.0	15.0	12.0	6.8
30000	27215B303J00	13.0	15.0	12.0	6.8
33000	27215B333J00	13.0	15.0	13.0	7.5
36000	27215B363J00	13.0	16.0	13.0	7.5
39000	27215B393J00	15.0	16.0	13.0	7.5
43000	27215B433J00	15.0	16.0	13.0	7.5
47000	27215B473J00	15.0	16.0	13.0	7.5
50000	27215B503J00	15.0	16.0	15.0	7.5
51000	27215B513J00	15.0	16.0	15.0	7.5
2000 Peak Volts					
8200	27220B822J00	10.0	10.0	7.5	3.9
9100	27220B912J00	11.0	10.0	8.2	4.3
10000	27220B103J00	11.0	11.0	8.2	4.3
11000	27220B113J00	11.0	11.0	8.2	4.7
12000	27220B123J00	11.0	11.0	9.1	4.7
13000	27220B133J00	12.0	12.0	9.1	5.1
15000	27220B153J00	12.0	12.0	10.0	5.1
16000	27220B163J00	12.0	12.0	10.0	5.6
18000	27220B183J00	12.0	13.0	10.0	5.6
20000	27220B203J00	13.0	13.0	11.0	6.2
22000	27220B223J00	13.0	13.0	11.0	6.2
3000 Peak Volts					
2700	27230B272J00	8.2	6.8	4.3	2.2
3000	27230B302J00	8.2	6.8	4.7	2.2
3300	27230B332J00	8.2	6.8	4.7	2.4
3600	27230B362J00	8.2	7.5	5.1	2.4
3900	27230B392J00	9.1	7.5	5.6	2.7
4300	27230B432J00	9.1	7.5	5.6	2.7
4700	27230B472J00	9.1	8.2	6.2	3.0
5000	27230B502J00	9.1	8.2	6.2	3.0

High-Voltage Types Application Guide, Transmitting Mica

Type 272 Ratings

Cap (pF)	Catalog Part Number	Maximum AC Current at 65 °C			
		3 MHz (A)	1 MHz (A)	300 kHz (A)	100 kHz (A)
3000 Peak Volts					
5100	27230B512J00	9.1	8.2	6.2	3.0
5600	27230B562J00	9.1	9.1	6.2	3.3
6000	27230B602J00	10.0	9.1	6.8	3.6
6200	27230B622J00	10.0	9.1	6.8	3.6
6800	27230B682J00	10.0	9.1	6.8	3.6
7500	27230B752J00	10.0	9.1	6.8	3.9
5000 Peak Volts					
47	27250B470J00	1.5	0.6	0.2	0.1
51	27250B510J00	1.6	0.7	0.2	0.1
56	27250B560J00	1.8	0.8	0.3	0.1
62	27250B620J00	1.8	0.8	0.3	0.1
68	27250B680J00	2.0	0.9	0.3	0.1
75	27250B750J00	2.0	1.0	0.4	0.1
82	27250B820J00	2.2	1.1	0.4	0.1
91	27250B910J00	2.4	1.2	0.4	0.1
100	27250B101J00	2.4	1.2	0.4	0.1
110	27250B111J00	2.7	1.3	0.5	0.2
120	27250B121J00	2.7	1.5	0.6	0.2
130	27250B131J00	3.0	1.6	0.6	0.2
150	27250B151J00	3.3	1.8	0.7	0.2
160	27250B161J00	3.3	1.8	0.8	0.3
180	27250B181J00	3.3	2.0	0.8	0.3
200	27250B201J00	3.6	2.0	0.8	0.3
220	27250B221J00	3.6	2.2	0.9	0.4
240	27250B241J00	3.6	2.4	1.0	0.4
250	27250B251J00	3.6	2.4	1.0	0.4
270	27250B271J00	3.9	2.4	1.1	0.5
300	27250B301J00	3.9	2.7	1.1	0.5
330	27250B331J00	4.3	2.7	1.2	0.5
360	27250B361J00	4.3	2.7	1.3	0.6
390	27250B391J00	4.3	2.7	1.3	0.6
430	27250B431J00	4.7	3.0	1.5	0.7
470	27250B471J00	4.7	3.3	1.5	0.7
500	27250B501J00	4.7	3.3	1.6	0.8
510	27250B511J00	4.7	3.3	1.6	0.8
560	27250B561J00	5.1	3.6	1.8	0.8
600	27250B601J00	5.1	3.6	1.8	0.8
620	27250B621J00	5.1	3.6	1.8	0.8
680	27250B681J00	2.1	3.6	1.8	0.8
750	27250B751J00	5.6	3.9	2.2	0.9

Cap (pF)	Catalog Part Number	Maximum AC Current at 65 °C			
		3 MHz (A)	1 MHz (A)	300 kHz (A)	100 kHz (A)
5000 Peak Volts					
820	27250B821J00	5.6	3.9	2.4	1.0
910	27250B911J00	5.6	4.3	2.4	1.1
1000	27250B102J00	6.2	4.3	2.4	1.2
1100	27250B112J00	6.2	4.7	2.7	1.2
1200	27250B122J00	6.2	4.7	2.7	1.3
1300	27250B132J00	6.8	5.1	3.0	1.3
1500	27250B152J00	6.8	5.1	3.3	1.5
1600	27250B162J00	6.8	5.6	3.6	1.5
1800	27250B182J00	7.5	5.6	3.6	1.6
2000	27250B202J00	7.5	6.2	3.6	1.8
2200	27250B222J00	7.5	6.2	3.9	2.0
2400	27250B242J00	8.2	6.2	4.3	2.0
40000 Peak Volts					
1100	272400B112J00	15.5	12.7	8.0	4.7
1300	272400B132J00	18.7	15.5	9.8	5.9
1500	272400B152J00	19.4	16.4	10.5	6.3
50000 Peak Volts					
900	272500B901J00	16.4	13.1	8.2	4.9
1000	272500B102J00	16.6	13.5	8.6	5.1
1200	272500B122J00	18.1	14.9	9.4	5.6
60000 Peak Volts					
800	272600B801J00	16.0	12.5	7.7	4.6
900	272600B901J00	16.4	13.1	8.2	4.9
1000	272600B102J00	16.3	13.3	8.5	5.1

Type 273 Ratings

400 Peak Volts					
1000000	27304B204J00	18.0	25.0	22.0	12.0
600 Peak Volts					
200000	27306B204J00	18.0	25.0	22.0	12.0
250000	27306B254J00	18.0	25.0	22.0	12.0
300000	27306B304J00	18.0	25.0	22.0	12.0
400000	27306B404J00	18.0	25.0	22.0	12.0
500000	27306B504J00	18.0	25.0	22.0	12.0
600000	27306B604J00	18.0	25.0	22.0	12.0
750000	27306B754J00	18.0	25.0	22.0	12.0
2000 Peak Volts					
100000	27320B104J00	18.0	23.0	18.0	10.5
4000 Peak Volts					
25000	27340B253J00	18.0	24.0	19.0	11.5
30000	27340B303J00	18.0	24.0	19.0	11.5

High-Voltage Types Application Guide, Transmitting Mica

Type 273 Ratings

Cap (pF)	Catalog Part Number	Maximum AC Current at 65 °C			
		3 MHz (A)	1 MHz (A)	300 kHz (A)	100 kHz (A)
4000 Peak Volts					
40000	27340B403JO0	18.0	24.0	20.0	12.0
50000	27340B503JO0	18.0	25.0	21.0	12.0
5000 Peak Volts					
20000	27350B203JO0	18.0	23.0	18.0	10.5
8000 Peak Volts					
200	27380B201JO0	7.5	5.0	1.5	0.5
250	27380B251JO0	7.5	5.0	1.5	0.5
500	27380B501JO0	8.5	6.0	3.0	1.0

Cap (pF)	Catalog Part Number	Maximum AC Current at 65 °C			
		3 MHz (A)	1 MHz (A)	300 kHz (A)	100 kHz (A)
8000 Peak Volts					
1000	27380B102JO0	10.0	8.5	4.5	1.5
2000	27380B202JO0	11.5	11.5	7.5	3.0
3000	27380B302JO0	12.5	13.5	9.5	4.0
4000	27380B402JO0	13.5	15.5	10.5	5.0
4500	27380B452JO0	14.0	16.0	11.5	6.0
5000	27380B502JO0	14.0	16.0	11.5	6.0
6000	27380B602JO0	15.0	17.0	12.5	6.5
8000	27380B802JO0	16.0	19.0	14.0	7.5
60000	27380B103JO0	17.0	20.0	15.0	8.5

Dimensions

Type 271



High-Voltage Types Application Guide, Transmitting Mica

Type 272

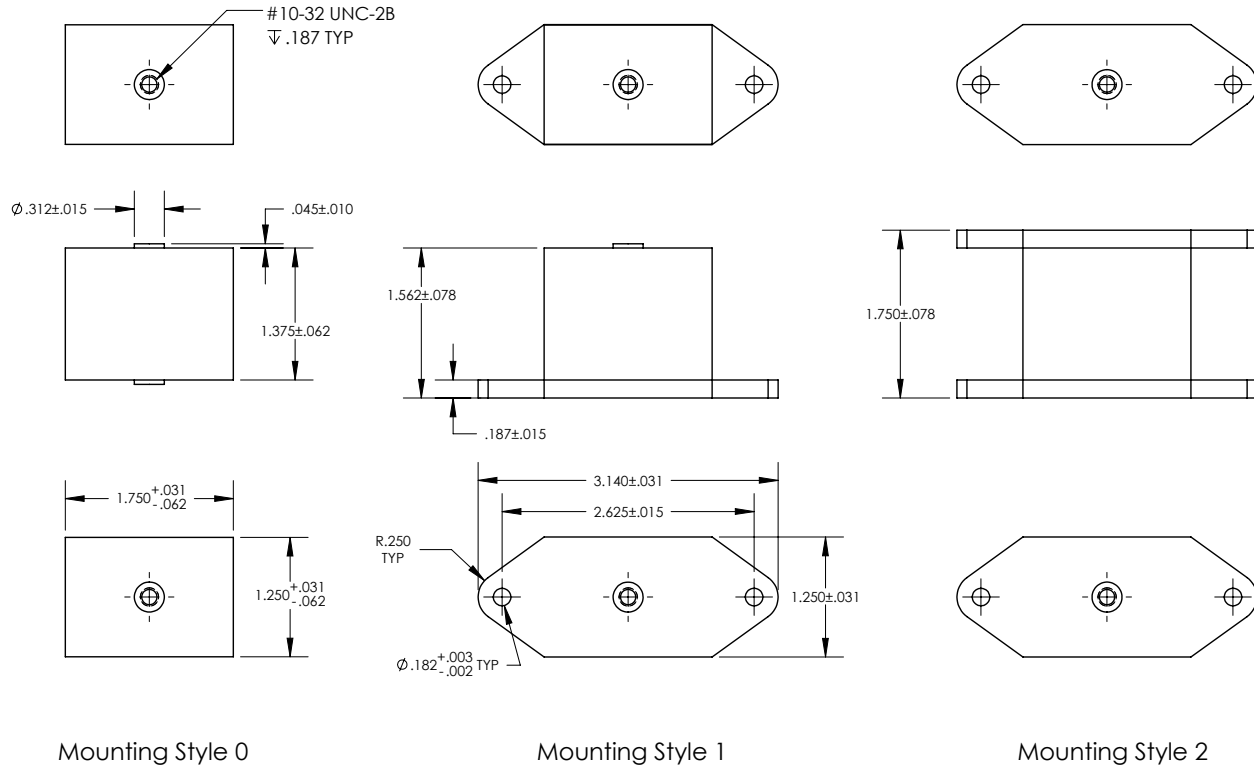

Type 272 (30 kVpk to 60 kVpk)



High-Voltage Types Application Guide, Transmitting Mica

Type 273

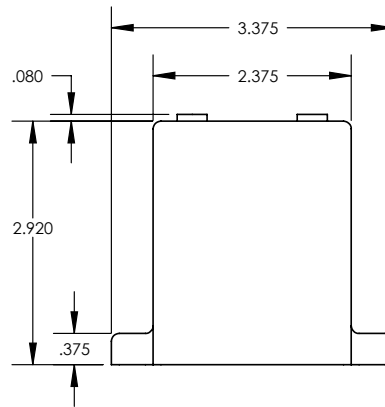

Tolerances Unless
Otherwise Specified $\pm .031$

Type 271 (CM 66)
Rated Current Versus Frequency



Type 273
Rated Current Versus Frequency



Type 272 (CM 71)
Rated Current Versus Frequency

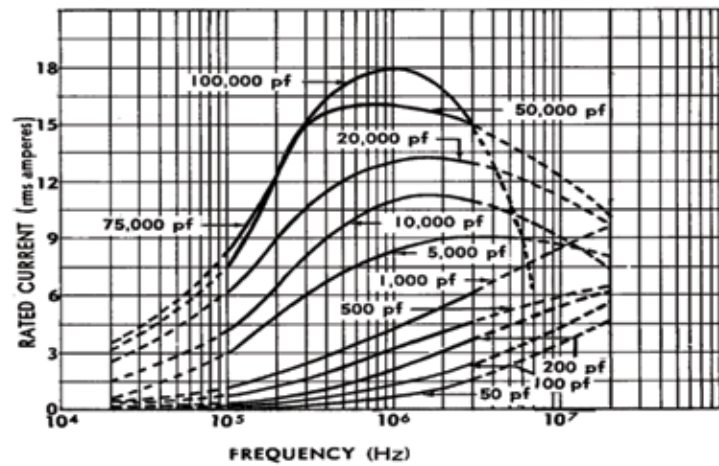

High-Voltage Types Ordering Information, Mica Capacitors

Ordering Information

Ordering Information: Order by complete part number, as below. For other options, write your requirements on your quote request or purchase order.

Cast-Case Part Numbering System



	Temp. Coeff. ppm/°C	Capacitance Drift	Standard Cap. Range
B	Not specified	Not specified	
C	-200 to +200	±(0.5% +0.1pF)	1-18 pF
D	-100 to +100	±(0.3% +0.1pF)	
E	- 20 to +100	±(0.1% +0.1pF)	20-82 pF

Specifications

Capacitance is within tolerance when measured at these frequencies:

- 1–1000 pF @ 1 MHz
- > 1000 pF @ 1 kHz

Dissipation Factor is typically less than 0.05% when measured as above. Dissipation factor (DF) equals $2\pi fRC$, where f is the test frequency, R is the equivalent series resistance (Ω), and C is nominal capacitance (F). Q is the reciprocal of the dissipation factor.

Operating Temperature Range is $-55\text{ }^{\circ}\text{C}$ to $+125\text{ }^{\circ}\text{C}$. Insulation Resistance is no less than $7500\text{ M}\Omega$ when measured at 100 Vdc.

Temperature Coefficient and Capacitance Drift: Measure the capacitors' capacitance at $25\text{ }^{\circ}\text{C}$, $55\text{ }^{\circ}\text{C}$, $25\text{ }^{\circ}\text{C}$, $125\text{ }^{\circ}\text{C}$, and at $25\text{ }^{\circ}\text{C}$ after stabilizing at each temperature. The capacitance will meet the limits of the Characteristic table shown in Ordering Information.

Rated Peak Voltage is not to be exceeded in actual use. Voltage ratings are in the listings and apply under the following conditions:

- Temperature: Within the specified operating temperature range.
- Altitude: Up to 50,000 feet or 3.4 inches of mercury.
- Relative Humidity: Up to 80%.
- Frequency: As specified.
- Where pulse conditions are encountered, contact us.

Withstanding Voltage: Capacitors will withstand application of an ac potential between terminals having an rms value equal to the rated peak voltage at a frequency of 100 Hz or less without damage, arcing or breakdown. Apply the potential by raising the voltage from zero to the specified value. Apply the full potential for a minimum of 5 seconds.

Case Insulation: Capacitor cases will withstand, without damage, arcing or breakdown, a 60-Hz peak ac potential equal to twice the rated peak voltage applied between the terminals connected together and a metal electrode touching the case. Apply this potential for 1 to 5 seconds.

Current Ratings at various frequencies are in the listings and apply under the following conditions:

- Temperature: $65\text{ }^{\circ}\text{C}$ maximum
- Derating Factor: None

Vibration: Capacitors will withstand vibrational forces occurring at rates of from 10 to 55 Hz for $4\frac{1}{2}$ hours. The total excursion during vibration is 0.06 inches. At the end of this period, make the following inspections and tests:

Visual and Mechanical Inspection: No perceptible deterioration. Withstanding Voltage: As specified under Withstanding Voltage.

Insulation Resistance: No less than $7500\text{ M}\Omega$.

Capacitance Change: Not to exceed 3% of the nominal value or one picofarad, whichever is greater.

Temperature and Immersion Cycling: Capacitors will withstand the temperature and immersion cycles indicated in the tables below. Follow three temperature cycles by two immersion cycles. Make the measurements listed below no more than 30 minutes following the final immersion cycle:

Withstanding Voltage: As specified under Withstanding Voltage.

Insulation Resistance: No less than $7500\text{ M}\Omega$.

Capacitance: Change not to exceed 4% of the nominal value or one picofarad, whichever is greater.

Temperature Cycling Test Conditions

Steps	Temp (°C)	Interval (Minutes)
1	$-55 + 0$ -3	30
2	$25 + 10$ -5	10 to 15
3	$125 + 3$ -0	30
4	$25 + 10$ -5	10 to 15

Immersion Test Conditions

- Number of cycles: 2
- Duration of each immersion: 15 minutes
- Immersion bath: Saturated solution of sodium chloride and water
- Temp. of hot bath: $65 - 0 + 5\text{ }^{\circ}\text{C}$
- Temp. of cold bath: $25 - 0 + 10\text{ }^{\circ}\text{C}$

Life Test: Subject all capacitors to a temperature of $55\text{ }^{\circ}\text{C}$ for 48 hours. Then subject units cast in rectangular cases (Types 271, 272, and 273) to a 60-Hz rms voltage equal to the rated peak voltage for 250 hours. Subject units cast in cylindrical cases (Types 291, 292, 293, and 294) to a 60-Hz rms voltage equal to 90% of the rated peak voltage for 250 hours. In both tests, maintain the temperature at $125\text{ }^{\circ}\text{C}$. After test, the capacitors will meet these requirements:

Withstanding Voltage: As specified under Withstanding Voltage.

Insulation Resistance: No less than $7500\text{ M}\Omega$.

Capacitance Change: Within the limits given in the table below or one picofarad, whichever is greater.

Characteristic Maximum Cap.

B	$\pm 8\%$
C	$\pm 3\%$
D	$\pm 3\%$
E	$\pm 3\%$

In addition, the capacitor must show no visual damage and the markings must be legible.

High-Voltage Types **Application Guide, Transmitting Mica**

Notice and Disclaimer: All product drawings, descriptions, specifications, statements, information and data (collectively, the "Information") in this datasheet or other publication are subject to change. The customer is responsible for checking, confirming and verifying the extent to which the Information contained in this datasheet or other publication is applicable to an order at the time the order is placed. All Information given herein is believed to be accurate and reliable, but it is presented without any guarantee, warranty, representation or responsibility of any kind, expressed or implied. Statements of suitability for certain applications are based on the knowledge that the Cornell Dubilier company providing such statements ("Cornell Dubilier") has of operating conditions that such Cornell Dubilier company regards as typical for such applications, but are not intended to constitute any guarantee, warranty or representation regarding any such matter – and Cornell Dubilier specifically and expressly disclaims any guarantee, warranty or representation concerning the suitability for a specific customer application, use, storage, transportation, or operating environment. The Information is intended for use only by customers who have the requisite experience and capability to determine the correct products for their application. Any technical advice inferred from this Information or otherwise provided by Cornell Dubilier with reference to the use of any Cornell Dubilier products is given gratis (unless otherwise specified by Cornell Dubilier), and Cornell Dubilier assumes no obligation or liability for the advice given or results obtained. Although Cornell Dubilier strives to apply the most stringent quality and safety standards regarding the design and manufacturing of its products, in light of the current state of the art, isolated component failures may still occur. Accordingly, customer applications which require a high degree of reliability or safety should employ suitable designs or other safeguards (such as installation of protective circuitry or redundancies or other appropriate protective measures) in order to ensure that the failure of an electrical component does not result in a risk of personal injury or property damage. Although all product-related warnings, cautions and notes must be observed, the customer should not assume that all safety measures are indicated in such warnings, cautions and notes, or that other safety measures may not be required.



Компания «ЭлектроПласт» предлагает заключение долгосрочных отношений при поставках импортных электронных компонентов на взаимовыгодных условиях!

Наши преимущества:

- Оперативные поставки широкого спектра электронных компонентов отечественного и импортного производства напрямую от производителей и с крупнейших мировых складов;
- Поставка более 17-ти миллионов наименований электронных компонентов;
- Поставка сложных, дефицитных, либо снятых с производства позиций;
- Оперативные сроки поставки под заказ (от 5 рабочих дней);
- Экспресс доставка в любую точку России;
- Техническая поддержка проекта, помощь в подборе аналогов, поставка прототипов;
- Система менеджмента качества сертифицирована по Международному стандарту ISO 9001;
- Лицензия ФСБ на осуществление работ с использованием сведений, составляющих государственную тайну;
- Поставка специализированных компонентов (Xilinx, Altera, Analog Devices, Intersil, Interpoint, Microsemi, Aeroflex, Peregrine, Syfer, Eurofarad, Texas Instrument, Miteq, Cobham, E2V, MA-COM, Hittite, Mini-Circuits, General Dynamics и др.);

Помимо этого, одним из направлений компании «ЭлектроПласт» является направление «Источники питания». Мы предлагаем Вам помощь Конструкторского отдела:

- Подбор оптимального решения, техническое обоснование при выборе компонента;
- Подбор аналогов;
- Консультации по применению компонента;
- Поставка образцов и прототипов;
- Техническая поддержка проекта;
- Защита от снятия компонента с производства.



Как с нами связаться

Телефон: 8 (812) 309 58 32 (многоканальный)

Факс: 8 (812) 320-02-42

Электронная почта: org@eplast1.ru

Адрес: 198099, г. Санкт-Петербург, ул. Калинина, дом 2, корпус 4, литера А.