

24CE/924CE

Miniature Safety Electromechanical Switch

FEATURES

- Positive opening operation of Normally Closed contacts conforming to IEC/EN 60947-5-1-3
- Compact construction
- Pre-wired
- Die-cast Zinc housing
- Wide selection of actuators
- Cable length variations
- Side and bottom exit cable
- Simple two-screw mounting
- IP 65/66/67
- UL recognised; CSA certified (924CE), CE compliant, BG approved (24CE)

BENEFITS

- Suitable for applications where space is at a premium
- Fast and easy to install
- Suitable for difficult operating environments
- Application flexibility
- Enhanced choice for application
- Multiple plunger capability



(924CE Series Only)



(24CE Series Only)



The ranges 24CE and 924CE have been tested and approved to meet the requirements of the Low Voltage directive and positive opening safety contacts per IEC/EN 60947-5-1-3. The devices are CE marked. The red colour clearly differentiates this safety component in the application. The 924CE range also has UL and CSA approval.

It is possible for the end user to enhance the safety level of these switches from Category 1 per EN 954-1 on their own to Categories 2, 3 or 4 per EN 954-1 when the switches are used in conjunction with our wide range of FF-SR safety control modules to form a safety system.

Typical applications for these switches would use the roller plunger 24CE18 style in conjunction with cams on doors with hinges. Also available are a range of panel mounting or top mounting versions to ensure that small space or difficult mounting can be simply achieved.

Several contact arrangements are available.

24CE/924CE

WARNING

MISUSE OF DOCUMENTATION

- The information presented in this product sheet (or catalogue) is for reference only. DO NOT USE this document as system installation information.
- Complete installation, operation and maintenance information is provided in the instructions supplied with each product.

Failure to comply with these instructions could result in death or serious injury.

24CE Series

Miniature Safety Electromechanical Switch

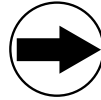

Technical Data

Mechanical life 10 million operations.

Degree of protection 24CE
Standard type: IP 66
With boot seal type: IP 67

Temperature range *Operating:* 0 °C to +70 °C / 32 °F to +160 °F

Approvals* IEC 60947-5-1
EN 60947-5-1
ac15 B300
dc13 R300

Electrical According to IEC/EN 60947-5-1.
Rated insulation voltage $U_i = 500$ V.
Rated impulse withstand voltage $U_{imp} = 2,5$ kV.
Not suitable for isolation.
SCPD, Quick blow fuse to IEC 127 suitable for rated current.

* See Standards (page 179)

Dimensions in mm / in

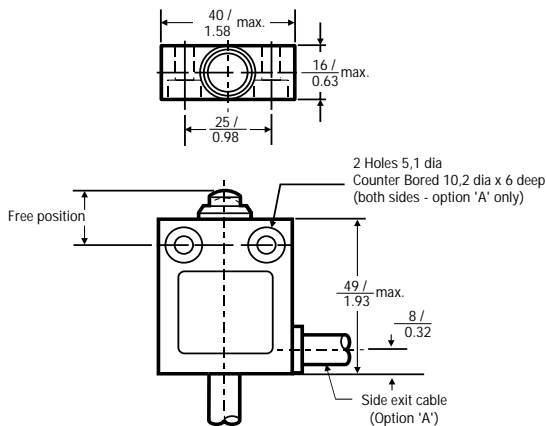

Cable Type
3 or 5 x 0,75 mm² harmonised CENELEC cable.

Ordering:

24CE

Example: 24CE18-Y1A

Actuator Types

Slow Action Contacts 1 Normally Closed

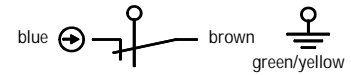

■ Circuit closed

* Positive opening to IEC/EN 60947-5-1-3

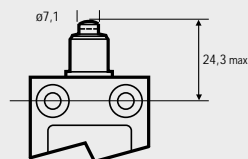
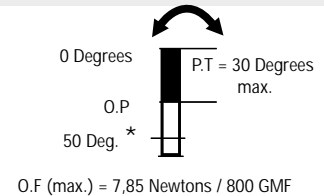
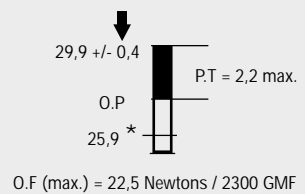
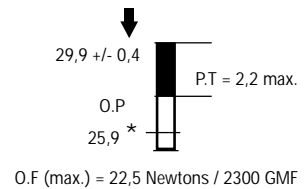
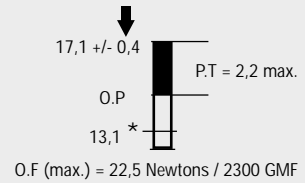

Pin Plunger (Boot Sealed)

18

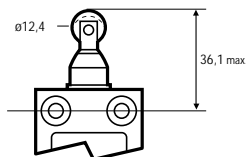
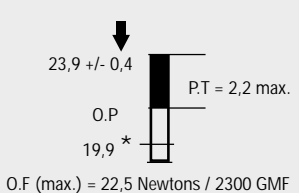

Roller Plunger Parallel (Boot Sealed)

31

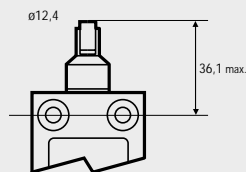
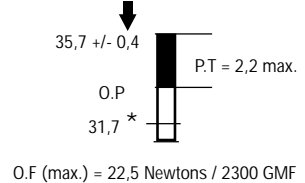

Roller Plunger Perpendicular (Boot Sealed)

55

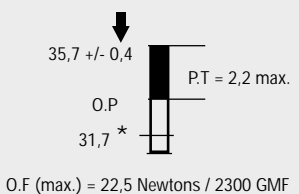

Y

X OR XX

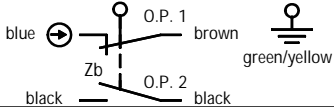
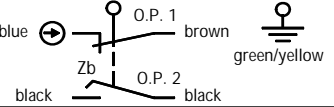
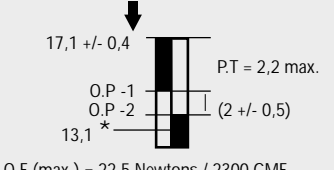
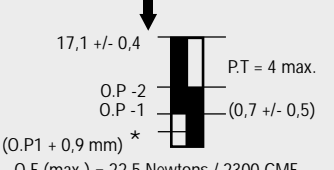
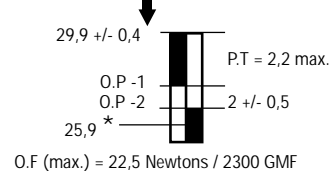
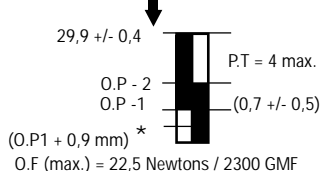
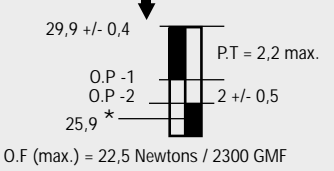
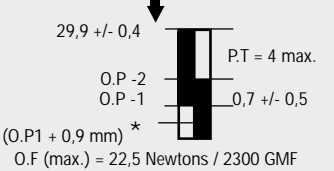
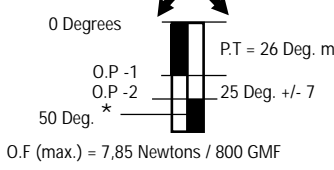
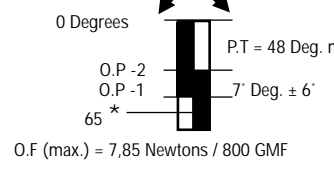
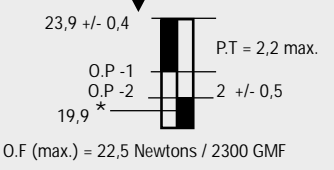
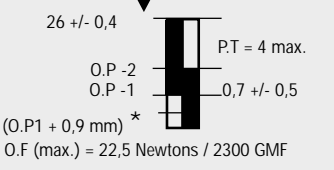
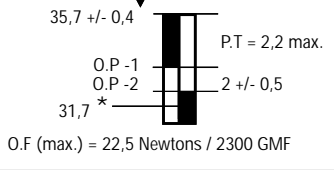
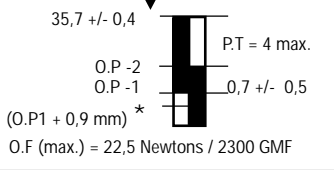
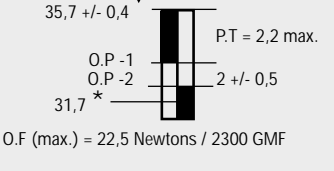
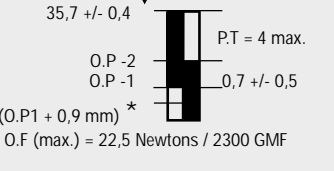
| <p>Slow Action Contacts 1 Normally Closed/ 1 Normally Open Break before make</p>  | <p>Slow Action Contacts 1 Normally Closed/ 1 Normally Open Make before break</p>  | <p>Cable Length (in metres)</p> | <p>Option Codes Available</p> |
|--|--|--|---|
|  |  | <p>Specify cable length in 1 metre increments e.g. 1 = 1 metre 2 = 2 metre etc.</p> | <p>A: Side Exit Cable.</p> |
|  |  | | |
|  |  | | |
| <p>0 Degrees</p>  | <p>0 Degrees</p>  | | |
|  |  | | |
|  |  | | |
|  |  | | |

24CE/924CE



924CE Series

Miniature Safety Electromechanical Switch



Technical Data

Mechanical life 10 million operations.

Degree of protection 924CE
Standard type: IP 66
With boot seal type: IP 67

Temperature range *Operating:* 0 °C to +105 °C /
32 °F to +221 °F

Approvals* IEC 60947-5-1
EN 60947-5-1
ac15 B300
dc13 R300
UL, CSA

Electrical According to IEC/EN 60947-5-1.
Rated insulation voltage
Ui = 500 V.
Rated impulse withstand voltage
Uimp = 2,5 kV.
Not suitable for isolation.
SCPD, Quick blow fuse to IEC
127 suitable for rated current.

* See Standards (page 179)

Dimensions in mm / in

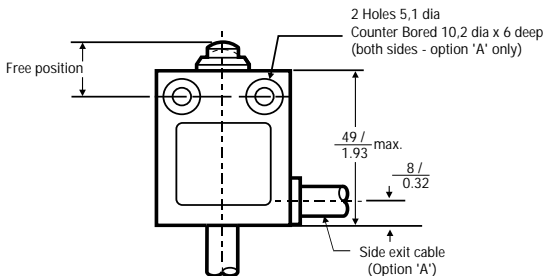
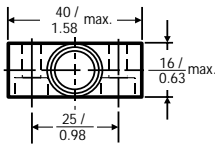

Cable Type
3 or 5 x 18 AWG SJTO CABLE

Ordering:

924CE

Example: 924CE18-Y3A

Actuator Types

Slow Action Contacts 1 Normally Closed



■ Circuit closed

*Positive opening to IEC/EN 60947-5-1-3

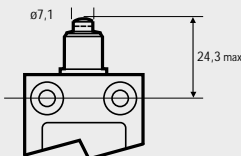
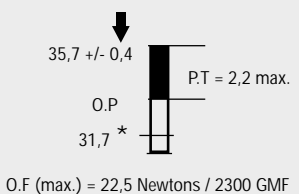
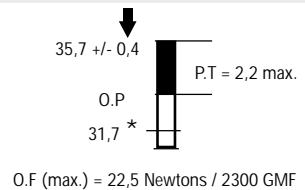
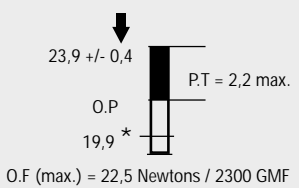
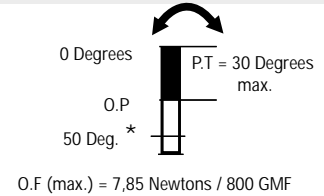
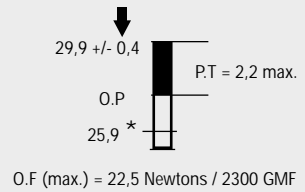
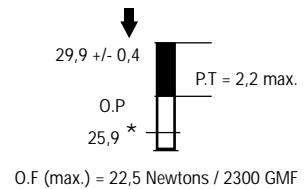
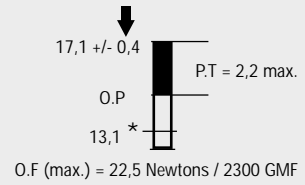

Pin Plunger (Boot Sealed)

18

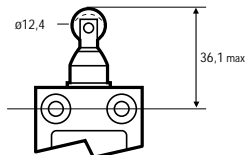

Roller Plunger Parallel (Boot Sealed)

31

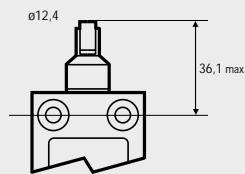

Roller Plunger Perpendicular (Boot Sealed)

55

Y

X OR XX

| Slow Action Contacts 1 Normally Closed/ Break before make | Slow Action Contacts 1 Normally Closed/ Make before break | Cable Length (in feet) | Option Codes |
|--|--|---|---------------------------|
| | | Specify cable length in 3 feet increments e.g. 3 = 3 feet 6 = 6 feet etc. | A: Side Exit Cable |
| <p>O.F (max.) = 22,5 Newtons / 2300 GMF</p> | <p>O.F (max.) = 22,5 Newtons / 2300 GMF</p> | | |
| <p>O.F (max.) = 22,5 Newtons / 2300 GMF</p> | <p>O.F (max.) = 22,5 Newtons / 2300 GMF</p> | | |
| <p>O.F (max.) = 22,5 Newtons / 2300 GMF</p> | <p>O.F (max.) = 22,5 Newtons / 2300 GMF</p> | | |
| <p>O.F (max.) = 7,85 Newtons / 800 GMF</p> | <p>O.F (max.) = 7,85 Newtons / 800 GMF</p> | | |
| <p>O.F (max.) = 22,5 Newtons / 2300 GMF</p> | <p>O.F (max.) = 22,5 Newtons / 2300 GMF</p> | | |
| <p>O.F (max.) = 22,5 Newtons / 2300 GMF</p> | <p>O.F (max.) = 22,5 Newtons / 2300 GMF</p> | | |
| <p>O.F (max.) = 22,5 Newtons / 2300 GMF</p> | <p>O.F (max.) = 22,5 Newtons / 2300 GMF</p> | | |

24CE/924CE





Компания «ЭлектроПласт» предлагает заключение долгосрочных отношений при поставках импортных электронных компонентов на взаимовыгодных условиях!

Наши преимущества:

- Оперативные поставки широкого спектра электронных компонентов отечественного и импортного производства напрямую от производителей и с крупнейших мировых складов;
- Поставка более 17-ти миллионов наименований электронных компонентов;
- Поставка сложных, дефицитных, либо снятых с производства позиций;
- Оперативные сроки поставки под заказ (от 5 рабочих дней);
- Экспресс доставка в любую точку России;
- Техническая поддержка проекта, помощь в подборе аналогов, поставка прототипов;
- Система менеджмента качества сертифицирована по Международному стандарту ISO 9001;
- Лицензия ФСБ на осуществление работ с использованием сведений, составляющих государственную тайну;
- Поставка специализированных компонентов (Xilinx, Altera, Analog Devices, Intersil, Interpoint, Microsemi, Aeroflex, Peregrine, Syfer, Eurofarad, Texas Instrument, Miteq, Cobham, E2V, MA-COM, Hittite, Mini-Circuits, General Dynamics и др.);

Помимо этого, одним из направлений компании «ЭлектроПласт» является направление «Источники питания». Мы предлагаем Вам помощь Конструкторского отдела:

- Подбор оптимального решения, техническое обоснование при выборе компонента;
- Подбор аналогов;
- Консультации по применению компонента;
- Поставка образцов и прототипов;
- Техническая поддержка проекта;
- Защита от снятия компонента с производства.



Как с нами связаться

Телефон: 8 (812) 309 58 32 (многоканальный)

Факс: 8 (812) 320-02-42

Электронная почта: org@eplast1.ru

Адрес: 198099, г. Санкт-Петербург, ул. Калинина, дом 2, корпус 4, литера А.