

G2R

PCB Power Relay

The Best Seller G2R



- 1 General purpose power Relays of single-pole 10 A and double-pole 5 A.
- Safety-oriented design with dielectric strength of 5,000 V between coil and contacts, and surge resistance of 10,000 V.
- AC and DC types are both available for operational coils.

RoHS Compliant



Model Number Legend

G2R-□-□□□□-□□
 1 2 3 4 5 6 7

1. Relay Function

None: Single-side stable
 K : Double-winding latching

2. Number of poles

1: 1-pole
 2: 2-pole

3. Contact Form

None: NO/NC
 A : NO

4. Contact Type

None: Single
 Z : Bifurcated contact

5. Enclosure rating

None: Flux protection
 (T-type is an enclosed relay)
 4 : Fully sealed

6. Terminal Shape

None: PCB terminals
 T : Quick-connect
 (upper bracket mounting #187)

7. Classification

None: Standard
 E : High-capacity
 H : High-sensitivity
 U : For ultrasonically cleanable
 Z : Full-wave rectifier

G
2
R

Model Configuration

| Terminal Shape | Classification | Number of poles | | 1-pole | | 2-pole | | Minimum packing unit |
|-------------------------|--------------------|------------------|--------------|--------------|-----------|--------------|-----------|----------------------|
| | | Enclosure rating | Contact form | SPST-NO (1a) | SPDT (1c) | DPST-NO (2a) | DPDT (2c) | |
| PCB terminals | Standard | Flux protection | AC | G2R-1A | G2R-1 | G2R-2A | G2R-2 | 100 pcs/tray |
| | | | DC | | | | | |
| | | Fully sealed | AC | G2R-1A4 | G2R-14 | G2R-2A4 | G2R-24 | |
| | | | DC | | | | | |
| | Bifurcated contact | Flux protection | AC | G2R-1AZ | G2R-1Z | - | - | 50 pcs/tray |
| | | | DC | | | | | |
| | Fully sealed | Flux protection | AC | G2R-1AZ4 | G2R-1Z4 | - | - | |
| | | | DC | | | | | |
| | High-capacity | Flux protection | AC | G2R-1A-E | G2R-1-E | - | - | 100 pcs/tray |
| | | | DC | | | | | |
| High-sensitivity | Flux protection | AC | G2R-1A-H | G2R-1-H | G2R-2A-H | G2R-2-H | | |
| | | DC | | | | | | |
| Double-winding latching | Flux protection | AC | G2RK-1A | G2RK-1 | G2RK-2A | G2RK-2 | | |
| | | DC | | | | | | |
| Quick-connect | Standard | Unsealed | AC | G2R-1A-T | G2R-1-T | - | - | 100 pcs/tray |
| | | | DC | | | | | |

Note 1. Full-wave rectifier and supersonic cleaner compatible models are also available. Refer to page 3.
 2. Sockets for PCB terminal models are not provided.

Ordering Information

PCB Terminal Models

| Classification | Enclosure rating | Number of poles Contact form | 1-pole | | 2-pole | | |
|----------------------|------------------|---------------------------------|-----------------------|-----------------------|-----------------------|-----------------------|------------------|
| | | | Model | Rated coil voltage | Model | Rated coil voltage | |
| Standard | Flux protection | NO | G2R-1A | 12, 24, 100/(110) VAC | G2R-2A | 12, 24, 100/(110) VAC | |
| | | | | 200/(220) VAC | | 200/(220) VAC | |
| | | | | 5, 6, 12, 24, 48 VDC | | 5, 6, 12, 24, 48 VDC | |
| | | | | 100 VDC | | 100 VDC | |
| | NO/NC | G2R-1 | G2R-2 | 12, 24, 100/(110) VAC | 12, 24, 100/(110) VAC | | |
| | | | | 200/(220) VAC | 200/(220) VAC | | |
| | | | | 5, 6, 12, 24, 48 VDC | 5, 6, 12, 24, 48 VDC | | |
| | | | | 100 VDC | 100 VDC | | |
| | Fully sealed | NO | G2R-1A4 | 12, 24, 100/(110) VAC | G2R-2A4 | 12, 24, 100/(110) VAC | |
| | | | | 200/(220) VAC | | 200/(220) VAC | |
| | | | | 5, 6, 12, 24, 48 VDC | | 5, 6, 12, 24, 48 VDC | |
| | | | | 100 VDC | | 100 VDC | |
| NO/NC | G2R-14 | G2R-24 | 12, 24, 100/(110) VAC | 12, 24, 100/(110) VAC | | | |
| | | | 200/(220) VAC | 200/(220) VAC | | | |
| | | | 5, 6, 12, 24, 48 VDC | 5, 6, 12, 24, 48 VDC | | | |
| | | | 100 VDC | 100 VDC | | | |
| High-sensitivity | Flux protection | NO | G2R-1A-H | 5, 6, 12, 24, 48 VDC | G2R-2A-H | 5, 6, 12, 24, 48 VDC | |
| | | NO/NC | G2R-1-H | 5, 6, 12, 24, 48 VDC | G2R-2-H | 5, 6, 12, 24, 48 VDC | |
| | | Double-winding latching | NO | G2RK-1A | 5, 6, 12, 24 VDC | G2RK-2A | 5, 12, 24 VDC |
| | | | NO/NC | G2RK-1 | 5, 6, 12, 24 VDC | G2RK-2 | 5, 6, 12, 24 VDC |
| Bifurcated contact | Flux protection | NO | G2R-1AZ | 12, 24, 48 VDC | - | - | |
| | | 100 VDC | | | | | |
| | NO/NC | G2R-1Z | 5, 6, 12, 24, 48 VDC | | | | |
| | 100 VDC | | | | | | |
| Fully sealed | NO | G2R-1AZ4 | 5, 12, 24, 48 VDC | | | | |
| | 100 VDC | | | | | | |
| NO/NC | G2R-1Z4 | 5, 12, 24, 48 VDC | | | | | |
| 100 VDC | | | | | | | |
| High-capacity | Flux protection | NO | G2R-1A-E | 12, 24, 100/(110) VAC | - | - | |
| | | | | 200/(220) VAC | | | |
| | | | | 5, 6, 12, 24, 48 VDC | | | |
| | | | | 100 VDC | | | |
| | NO/NC | G2R-1-E | 12, 24, 100/(110) VAC | | | | |
| | | | 200/(220) VAC | | | | |
| 5, 6, 12, 24, 48 VDC | | | | | | | |
| 100 VDC | | | | | | | |

Note: When ordering, add the rated coil voltage to the model number.

Example: G2R-1A AC12

Rated coil voltage

However, the notation of the coil voltage on the product case as well as on the packing will be marked as □□ VAC.

● Quick-connect Terminal (#187)

| Classification | Enclosure rating | Number of poles Contact form | 1-pole | |
|----------------|------------------|---------------------------------|----------|-----------------------|
| | | | Model | Rated coil voltage |
| Standard | Unsealed | NO | G2R-1A-T | 12, 24, 100/(110) VAC |
| | | | | 200/(220) VAC |
| | | | | 5, 6, 12, 24, 48 VDC |
| | | | | 100 VDC |
| | | NO/NC | G2R-1-T | 12, 24, 100/(110) VAC |
| | | | | 200/(220) VAC |
| | | | | 5, 6, 12, 24, 48 VDC |
| | | | | 100 VDC |

● Full-wave Rectifier

| Classification | Enclosure rating | Number of poles Contact form | 1-pole | | 2-pole | |
|----------------|------------------|---------------------------------|-----------|--------------------|-----------|----------------------|
| | | | Model | Rated coil voltage | Model | Rated coil voltage |
| Standard | Flux protection | NO | G2R-1A-Z | 5, 12, 24 VDC | G2R-2A-Z | 5, 6, 12, 24, 48 VDC |
| | | | | 100 VDC | | 100 VDC |
| | | NO/NC | G2R-1-Z | 5, 12, 24, 48 VDC | G2R-2-Z | 12, 24, 48 VDC |
| | | | | 100 VDC | | 100 VDC |
| | Fully sealed | NO | G2R-1A4-Z | 5, 12, 48 VDC | G2R-2A4-Z | 24, 48 VDC |
| | | | | 100 VDC | | 100 VDC |
| | | NO/NC | G2R-14-Z | 5, 12, 24, 48 VDC | G2R-24-Z | 5, 12, 24 VDC |
| | | | | 100 VDC | | 100 VDC |
| High-capacity | Flux protection | NO | G2R-1A-EZ | 5, 12, 24 VDC | - | |
| | | | | 100 VDC | | |
| | | NO/NC | G2R-1-EZ | 12, 24, 48 VDC | | |

● For Ultrasonically Cleanable

| Classification | Enclosure rating | Number of poles Contact form | 1-pole | | 2-pole | |
|----------------|------------------|---------------------------------|-----------|-----------------------|-----------|--------------------|
| | | | Model | Rated coil voltage | Model | Rated coil voltage |
| Standard | Fully sealed | NO | G2R-1A4-U | 12, 24, 100/(110) VAC | G2R-2A4-U | 100/(110) VAC |
| | | | | 200/(220) VAC | | - |
| | | | | 5, 6, 12, 24, 48 VDC | | 5, 12, 24 VDC |
| | | | | | | |
| | | NO/NC | G2R-14-U | 100/(110) VAC | G2R-24-U | 24, 100/(110) VAC |
| | | | | 200/(220) VAC | | 200/(220) VAC |
| | | | | 5, 12, 24, 48 VDC | | 5, 12, 24, 48 VDC |
| | | | | 100 VDC | | 100 VDC |

Note: When ordering, add the rated coil voltage to the model number.

Example: G2R-1A-T AC12

Rated coil voltage

However, the notation of the coil voltage on the product case as well as on the packing will be marked as □□ VAC.

■ Ratings

● Coil

| Classification | Item Rated voltage | Rated current (mA) | | Coil resistance (Ω) | Must operate voltage (V) | Must release voltage (V) | Max. voltage (V) | Power consumption (VA, W) |
|--|-----------------------|--------------------|-----------|---------------------|--------------------------|--------------------------|-------------------|---------------------------|
| | | 50 Hz | 60 Hz | | | | | |
| <ul style="list-style-type: none"> Standard Quick-connect Fully sealed High-capacity | 12 VAC | 93 | 75 | 65 | 80% max. | 30% min. | 140% (at 23°C) | Approx. 0.9 (60 Hz) |
| | 24 VAC | 46.5 | 37.5 | 260 | | | | |
| | 100/(110) VAC | 11 | 9/(10.6) | 4,600 | | | | |
| | 200/(220) VAC | 5.5 | 4.5/(5.3) | 20,200 | | | | |
| <ul style="list-style-type: none"> Standard High-capacity Bifurcated contact Quick-connect Fully sealed | 5 VDC | 106 | | 47 | 70% max. | 15% min. | 170% (at 23°C) | Approx. 0.53 |
| | 6 VDC | 88.2 | | 68 | | | | |
| | 12 VDC | 43.6 | | 275 | | | | |
| | 24 VDC | 21.8 | | 1,100 | | | | |
| | 48 VDC | 11.5 | | 4,170 | | | | |
| <ul style="list-style-type: none"> High-sensitivity | 5 VDC | 71.4 | | 70 | 70% max. | 15% min. | 170% (at 23°C) | Approx. 0.36 |
| | 6 VDC | 60 | | 100 | | | | |
| | 12 VDC | 30 | | 400 | | | | |
| | 24 VDC | 15 | | 1,600 | | | | |
| | 48 VDC | 7.5 | | 6,400 | | | | |

- Note 1. The rated current and coil resistance are measured at a coil temperature of 23°C with a tolerance of +15%/-20% (AC rated current) or ±10% (DC coil resistance).
 Note 2. AC coil resistances shown above are only reference values.
 Note 3. The operating characteristics are measured at a coil temperature of 23°C.
 Note 4. The "Max. voltage" is the maximum voltage that can be applied to the relay coil.

● Coil: Double-winding Latching Relays

| Item Rated voltage | Set Coil | | Reset coil | | Must set voltage (V) | Must reset voltage (V) | Max. voltage (V) | Power consumption | |
|-----------------------|--------------------|---------------------|--------------------|---------------------|----------------------|------------------------|-------------------|-------------------|-----------------|
| | Rated current (mA) | Coil resistance (Ω) | Rated current (mA) | Coil resistance (Ω) | | | | Set Coil (mW) | Reset coil (mW) |
| 5 VDC | 167 | 30 | 119 | 42 | 70% max. | 70% max. | 140% (at 23°C) | Approx. 850 | Approx. 600 |
| 6 VDC | 138 | 43.5 | 100 | 60 | | | | | |
| 12 VDC | 70.6 | 170 | 50 | 240 | | | | | |
| 24 VDC | 34.6 | 694 | 25 | 960 | | | | | |

- Note 1. The rated current and coil resistance are measured at a coil temperature of 23°C with a tolerance of ±10%.
 Note 2. The operating characteristics are measured at a coil temperature of 23°C.
 Note 3. The "Max. voltage" is the maximum voltage that can be applied to the relay coil.

● Contacts: Fully Protection Type

| Classification Number of poles Load Item | Standard type Quick-connect Terminal (1 single-pole type) | | | | High-capacity type | | Bifurcated contact type | | High-sensitivity type | | | |
|---|--|---|---------------------------------|---|-----------------------------------|---|---------------------------------|---|---------------------------------|---|---------------------------------|---|
| | 1-pole | | 2-pole | | 1-pole | | 2-pole | | 1-pole | | 2-pole | |
| | Resistive load | Inductive load ($\cos\phi = 0.4$; L/R = 7 ms) | Resistive load | Inductive load ($\cos\phi = 0.4$; L/R = 7 ms) | Resistive load | Inductive load ($\cos\phi = 0.4$; L/R = 7 ms) | Resistive load | Inductive load ($\cos\phi = 0.4$; L/R = 7 ms) | Resistive load | Inductive load ($\cos\phi = 0.4$; L/R = 7 ms) | Resistive load | Inductive load ($\cos\phi = 0.4$; L/R = 7 ms) |
| Contact type | Single | | | | Single | | Bifurcated | | Single | | | |
| Contact material | Ag-alloy (Cd free) | | | | | | | | | | | |
| Rated load | 10 A at 250 VAC 10 A at 30 VDC | 7.5 A at 250 VAC 5 A at 30 VDC | 5 A at 250 VAC 5 A at 30 VDC | 2 A at 250 VAC 3 A at 30 VDC | 16 A at 250 VAC 16 A at 30 VDC | 8 A at 250 VAC 8 A at 30 VDC | 5 A at 250 VAC 5 A at 30 VDC | 2 A at 250 VAC 3 A at 30 VDC | 5 A at 250 VAC 5 A at 30 VDC | 2 A at 250 VAC 3 A at 30 VDC | 3 A at 250 VAC 3 A at 30 VDC | 1 A at 250 VAC 1.5 A at 30 VDC |
| Rated carry current | 10 A | | 5 A | | 16 A | | 5 A | | 5 A | | 3 A | |
| Max. switching voltage | 380 VAC, 125 VDC | | | | 380 VAC, 125 VDC | | | | 380 VAC, 125 VDC | | | |
| Max. switching current | 10 A | | 5 A | | 16 A | | 5 A | | 5 A | | 3 A | |
| Failure rate (P level) (reference value) * | 100 mA at 5 VDC | | 10 mA at 5 VDC | | 100 mA at 5 VDC | | 1 mA at 5 VDC | | 100 mA at 5 VDC | | 10 mA at 5 VDC | |

* This value was measured at a switching frequency of 120 operations/min.

● Contacts: Flux Sealed Type

| Classification Number of poles Load Item | Standard type (Single contact type) | | | | Bifurcated contact type | |
|---|--------------------------------------|--|--------------------------------------|--|--------------------------------------|--|
| | 1-pole | | 2-pole | | 1-pole | |
| | Resistive load ($\cos\phi = 1$) | Inductive load ($\cos\phi = 0.4$; L/R = 7 ms) | Resistive load ($\cos\phi = 1$) | Inductive load ($\cos\phi = 0.4$; L/R = 7 ms) | Resistive load ($\cos\phi = 1$) | Inductive load ($\cos\phi = 0.4$; L/R = 7 ms) |
| Contact type | Single | | | | Bifurcated | |
| Contact material | Ag-alloy (Cd free) | | | | | |
| Rated load | 8 A at 250 VAC 8 A at 30 VDC | 6 A at 250 VAC 4 A at 30 VDC | 4 A at 250 VAC 4 A at 30 VDC | 1.5 A at 250 VAC 2.5 A at 30 VDC | 5 A at 250 VAC 5 A at 30 VDC | 2 A at 250 VAC 3 A at 30 VDC |
| Rated carry current | 8 A | | 4 A | | 5 A | |
| Max. switching voltage | 380 VAC, 125 VDC | | | | 380 VAC, 125 VDC | |
| Max. switching current | 8 A | | 4 A | | 5 A | |
| Failure rate (P level) (reference value) * | 100 mA at 5 VDC | | 10 mA at 5 VDC | | 1 mA at 5 VDC | |

* This value was measured at a switching frequency of 120 operations/min.

● Contacts: Latching Type

| Number of poles Load Item | 1-pole | | 2-pole | |
|---|--------------------------------------|--|--------------------------------------|--|
| | Resistive load ($\cos\phi = 1$) | Inductive load ($\cos\phi = 0.4$; L/R = 7 ms) | Resistive load ($\cos\phi = 1$) | Inductive load ($\cos\phi = 0.4$; L/R = 7 ms) |
| Contact type | Single | | Single | |
| Contact material | Ag-alloy (Cd free) | | | |
| Rated load | 5 A at 250 VAC 5 A at 30 VDC | 3.5 A at 250 VAC 2.5 A at 30 VDC | 3 A at 250 VAC 3 A at 30 VDC | 1.5 A at 250 VAC 2 A at 30 VDC |
| Rated carry current | 5 A | | 3 A | |
| Max. switching voltage | 380 VAC, 125 VDC | | | |
| Max. switching current | 5 A | | 3 A | |
| Failure rate (P level) (reference value) * | 100 mA at 5 VDC | | 10 mA at 5 VDC | |

* This value was measured at a switching frequency of 120 operations/min.

■ Characteristics

● Standard Relays

| Item | Number of poles | 1-pole | 2-pole |
|-------------------------------|--|---|-------------------------------|
| Contact resistance *1 | | 30 mΩ max. | 50 mΩ max. |
| Operate time *2 | | 15 ms max. | |
| Release time *2 | | AC: 10 ms max.; DC: 5 ms max. | |
| Max. operating frequency | Mechanical | 18,000 operations/hr | |
| | Electrical | 1,800 operations/hr | |
| Insulation resistance *3 | | 1,000 MΩ min. | |
| Dielectric strength | Between coil and contacts | 5,000 VAC, 50/60 Hz for 1 min | |
| | Between contacts of different polarity | - | 3,000 VAC, 50/60 Hz for 1 min |
| | Between contacts of the same polarity | 1,000 VAC, 50/60 Hz for 1 min | |
| Insulation distance | Between coil and contacts | Clearance: 8 mm, Creepage: 8 mm | |
| Vibration resistance | Destruction | 10 to 55 to 10 Hz, 0.75 mm single amplitude (1.5 mm double amplitude) | |
| | Malfunction | 10 to 55 to 10 Hz, 0.75 mm single amplitude (1.5 mm double amplitude) | |
| Shock resistance | Destruction | 1,000 m/s ² | |
| | Malfunction | 200 m/s ² when energized; 100m/s ² when no energized | |
| Durability | Mechanical | AC coil: 10,000,000 operations min.; DC coil: 20,000,000 operations min. (at 1,800 operations/hr) | |
| | Electrical | 100,000 operations min. (at 1,800 operations/hr under rated load) | |
| Ambient operating temperature | | -40°C to 70°C (with no icing) | |
| Ambient operating humidity | | 5% to 85% | |
| Weight | | Approx. 17 g (Approx. 20 g *4) | |

Note: The values here are initial values.

- *1. Measurement conditions: 5 VDC, 1 A, voltage-drop method.
- *2. Measurement conditions: Rated operating voltage applied, not including contact bounce.
- *3. Measurement conditions: The insulation resistance was measured with a 500 VDC megohmmeter at the same locations as the dielectric strength was measured.
- *4. Value for quick-connect terminals.

Double-winding Latching Relays

| Item | Number of poles | 1-pole | 2-pole |
|-------------------------------|--|---|-------------------------------|
| Contact resistance *1 | | 30 mΩ max. | 50 mΩ max. |
| Set | Time *2 | 20 ms max. | |
| | Min. set pulse width *3 | 30 ms | |
| Reset | Time *2 | 20 ms max. | |
| | Min. reset pulse width *3 | 30 ms | |
| Max. operating frequency | Mechanical | 18,000 operations/hr | |
| | Electrical | 1,800 operations/hr | |
| Insulation resistance *4 | | 1,000 MΩ min. | |
| Dielectric strength | Between coil and contacts | 5,000 VAC, 50/60 Hz for 1 min | |
| | Between contacts of different polarity | - | 3,000 VAC, 50/60 Hz for 1 min |
| | Between contacts of the same polarity | 1,000 VAC, 50/60 Hz for 1 min | |
| | Between set and reset coils | 1,000 VAC, 50/60 Hz for 1 min | |
| Insulation distance | Between coil and contacts | Clearance: 8 mm, Creepage: 8 mm | |
| Vibration resistance | Destruction | 10 to 55 to 10 Hz, 0.75 mm single amplitude (1.5 mm double amplitude) | |
| | Malfunction | 10 to 55 to 10 Hz, 0.75 mm single amplitude (1.5 mm double amplitude) | |
| Shock resistance | Destruction | 1,000 m/s ² | |
| | Malfunction | Set: 500m/s ² Armature OFF Reset: 200m/s ² Contact OFF | |
| Durability | Mechanical | 10,000,000 operations min (at 18,000 operations/hr) | |
| | Electrical | 100,000 operations min. (at 1,800 operations/hr under rated load) | |
| Ambient operating temperature | | -40°C to 70°C (with no icing or condensation) | |
| Ambient operating humidity | | 5% to 85% | |
| Weight | | Approx. 17 g | |

Note: The values here are initial values.

- *1. Measurement conditions: 5 VDC, 1 A, voltage-drop method.
- *2. Measurement conditions: Rated operating voltage applied, not including contact bounce.
- *3. Measurement conditions: Rated operating voltage applied.
- *4. Measurement conditions: The insulation resistance was measured with a 500 VDC megohmmeter at the same locations as the dielectric strength was measured.

■ Engineering Data

● Maximum Switching Capacity

Flux Protection/Plug-in Relays

G2R-1, G2R-1A, G2R-1-T, G2R-1A-T

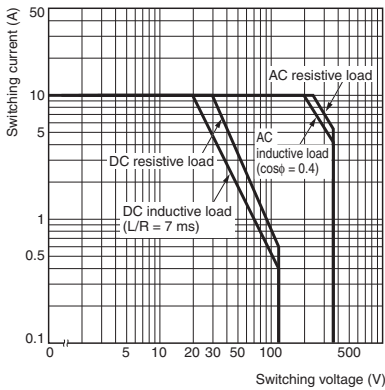

G2R-1-E, G2R-1A-E



G2R-1Z, G2R-1AZ



G2R-1-H, G2R-1A-H, G2R-2, G2R-2A

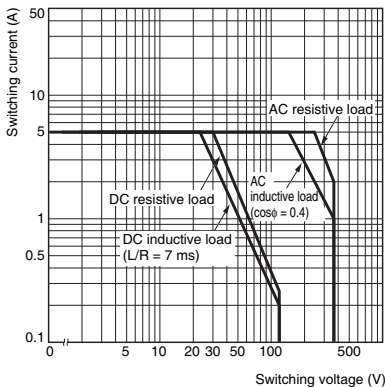

G2R-2-H, G2R-2A-H



G2RK-1A, G2RK-1



G2RK-2A, G2RK-2



Fully Sealed Relays

G2R-14, G2R-1A4



G2R-24, G2R-2A4



G2R-1Z4, G2R-1AZ4

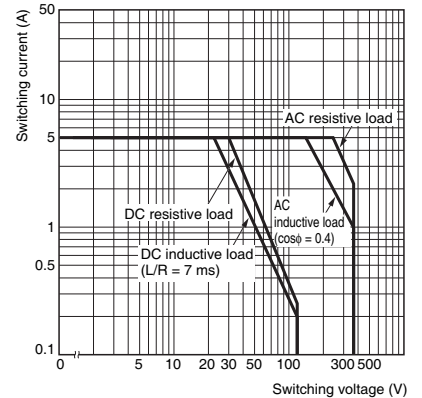

● Durability

Flux Protection/Plug-in Relays

G2R-1, G2R-1A, G2R-1-T, G2R-1A-T

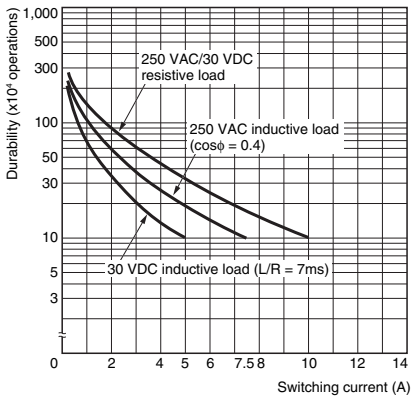

G2R-1-E, G2R-1A-E

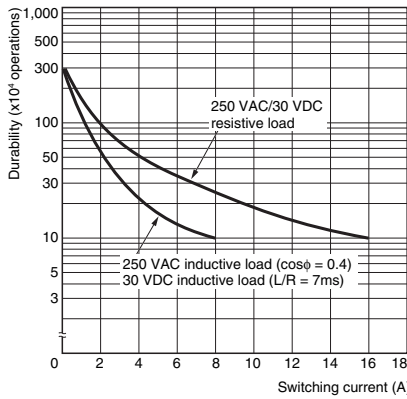

G2R-1Z, G2R-1AZ

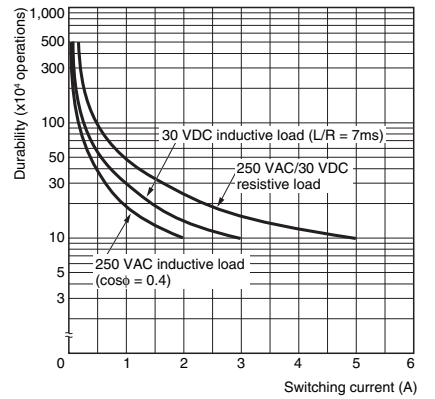

G2R-1-H, G2R-1A-H, G2R-2, G2R-2A



G2R-2-H, G2R-2A-H



G2RK-1A, G2RK-1



G2RK-2A, G2RK-2



Fully Sealed Relays

G2R-14, G2R-1A4



G2R-24, G2R-2A4

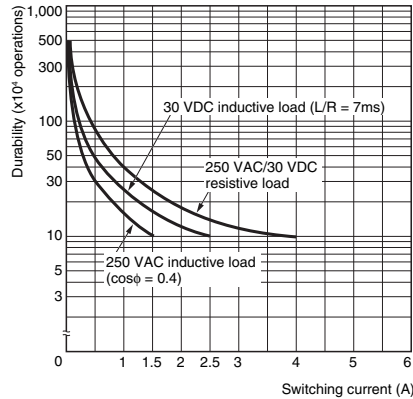

G2R-1Z4, G2R-1AZ4



● Ambient Temperature vs. Maximum Coil Voltage



Note: The maximum coil voltage refers to the maximum value in a varying range of operating power voltage, not a continuous voltage.

● Ambient Temperature vs. Must Operate and Must Release Voltage

G2R-1

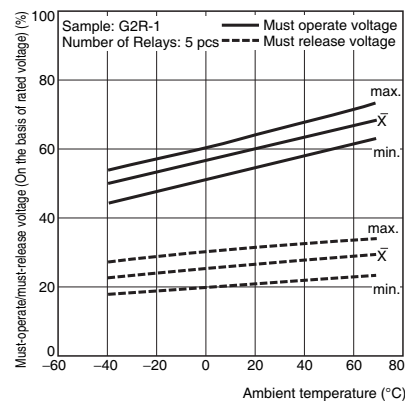

G2R-2



● Shock Malfunction

G2R-1 Number of Relays: 5 pcs

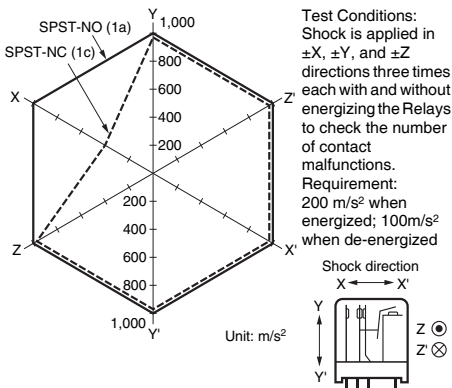

G2R-2 Number of Relays: 5 pcs

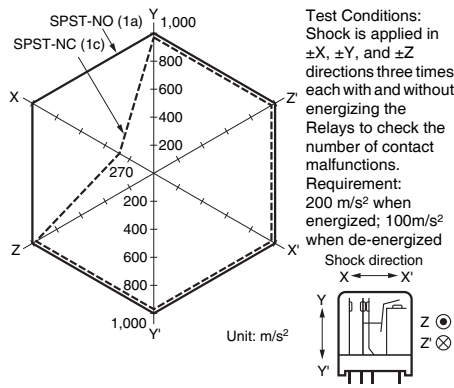

● Keep-power decrement with time

G2RK-1

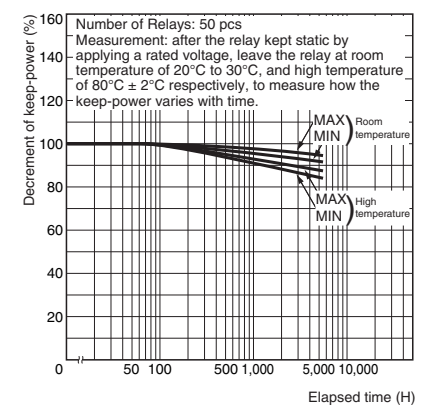

■ Dimensions

Relays with PCB Terminals

(SPDT (1c) Relays)

G2R-1(-Z)

G2R-1Z

G2R-1-H



This illustration is the G2R-1 model.

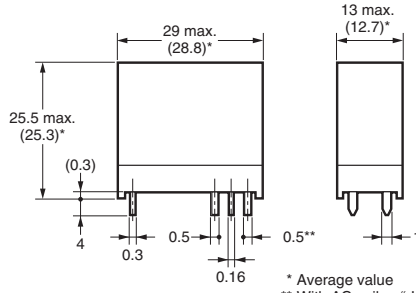

* Average value
** With AC coil or "-H" models: 0.3.

PCB Mounting Holes (BOTTOM VIEW)

Tolerance: ± 0.1 mm

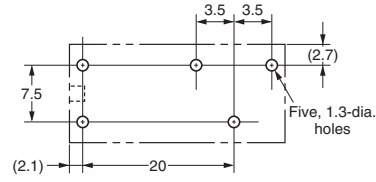

Terminal Arrangement/ Internal Connections (BOTTOM VIEW)



Relays with PCB Terminals

(SPST-NO (1a) Relays)

G2R-1A(-Z)

G2R-1AZ

G2R-1A-H

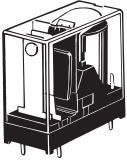

This illustration is the G2R-1A model.

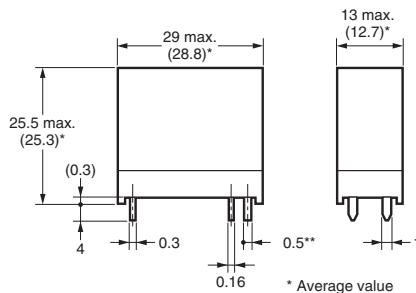

* Average value
** With AC coil or "-H" models: 0.3.

PCB Mounting Holes (BOTTOM VIEW)

Tolerance: ± 0.1 mm

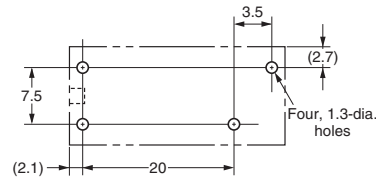

Terminal Arrangement/ Internal Connections (BOTTOM VIEW)

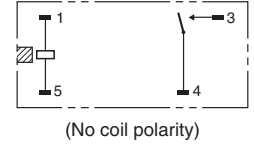

Relays with PCB Terminals

(SPDT (1c) /High-capacity Relays)

G2R-1-E(Z)

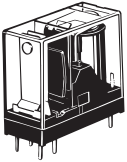

This illustration is the G2R-1-E model.

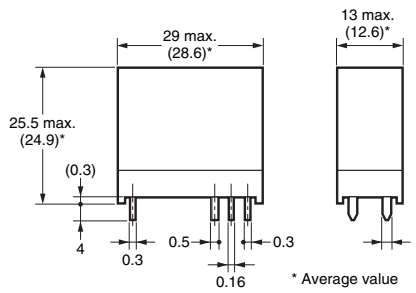

* Average value

PCB Mounting Holes (BOTTOM VIEW)

Tolerance: ± 0.1 mm

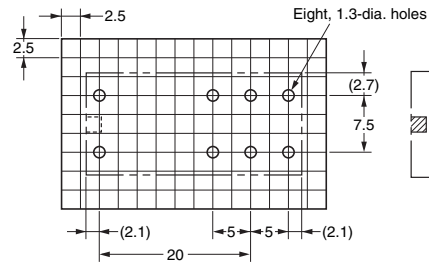

Terminal Arrangement/ Internal Connections (BOTTOM VIEW)



Relays with PCB Terminals

(SPST-NO (1a)/High-capacity Relays)

G2R-1A-E(Z)

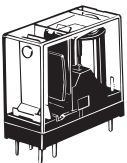

This illustration is the G2R-1A-E model.

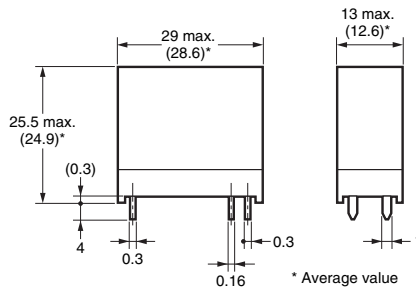

* Average value

PCB Mounting Holes (BOTTOM VIEW)

Tolerance: ± 0.1 mm

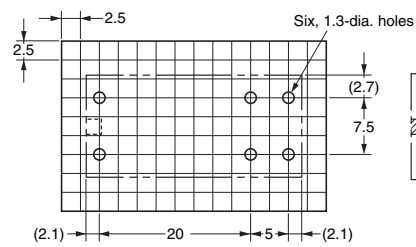

Terminal Arrangement/ Internal Connections (BOTTOM VIEW)

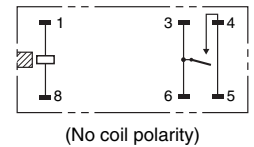

Note: Orientation marks are indicated as follows: □ ▨

**Relays with PCB Terminals
(SPDT (1c) Relays)
G2R-14(-Z)(-U)
G2R-1Z4**



**PCB Mounting Holes
(BOTTOM VIEW)
Tolerance: ±0.1 mm**



**Terminal Arrangement/
Internal Connections
(BOTTOM VIEW)**



**Relays with PCB Terminals
(SPST-NO (1a) Relays)
G2R-1A4(-Z)(-U)
G2R-1AZ4**



**PCB Mounting Holes
(BOTTOM VIEW)
Tolerance: ±0.1 mm**



**Terminal Arrangement/
Internal Connections
(BOTTOM VIEW)**



**Double-winding Latching Relays with
PCB Terminals
(SPDT (1c) Relays)
G2RK-1**

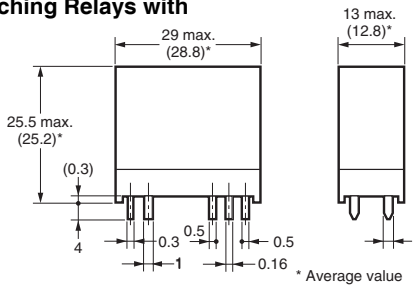

**PCB Mounting Holes
(BOTTOM VIEW)
Tolerance: ±0.1 mm**

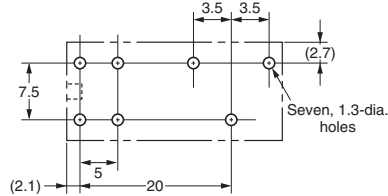

**Terminal Arrangement/
Internal Connections
(BOTTOM VIEW)**



**Double-winding Latching Relays with
PCB Terminals
(SPST-NO (1a) Relays)
G2RK-1A**

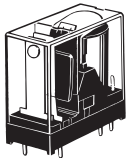

**PCB Mounting Holes
(BOTTOM VIEW)
Tolerance: ±0.1 mm**

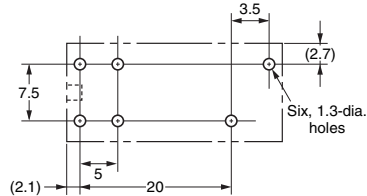

**Terminal Arrangement/
Internal Connections
(BOTTOM VIEW)**



**Double-winding Latching Relays with PCB Terminals
(DPDT (2c) Relays)
G2RK-2**

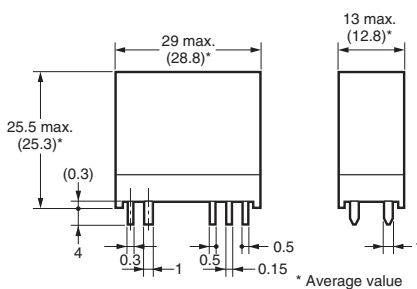

**PCB Mounting Holes
(BOTTOM VIEW)
Tolerance: ±0.1 mm**

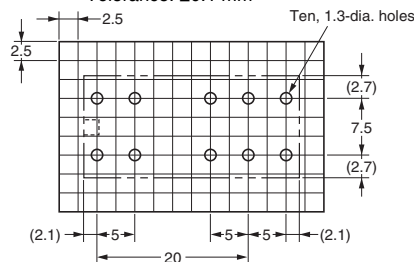

**Terminal Arrangement/
Internal Connections
(BOTTOM VIEW)**



**Double-winding Latching Relays with PCB Terminals
(DPST-NO (2a) Relays)
G2RK-2A**

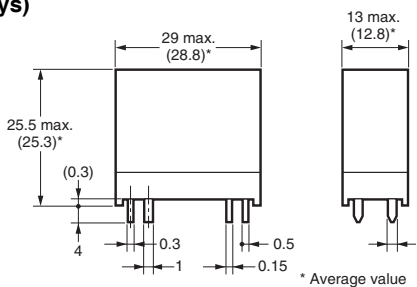

**PCB Mounting Holes
(BOTTOM VIEW)
Tolerance: ±0.1 mm**

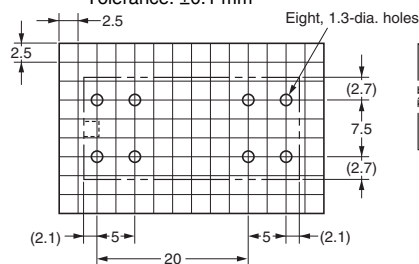

**Terminal Arrangement/
Internal Connections
(BOTTOM VIEW)**

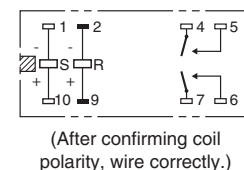

Note: Orientation marks are indicated as follows: [] []

**Relays with PCB Terminals
(DPDT (2c) Relays)
G2R-2(-Z)
G2R-2-H**

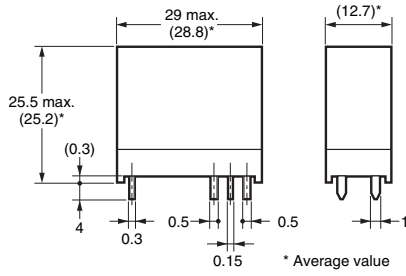

**Relays with PCB Terminals
(DPST-NO (2a) Relays)
G2R-2A
G2R-2A-H
G2R-2A-Z**

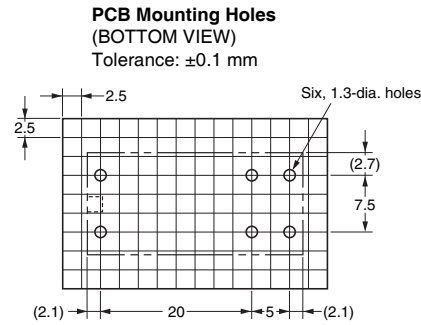
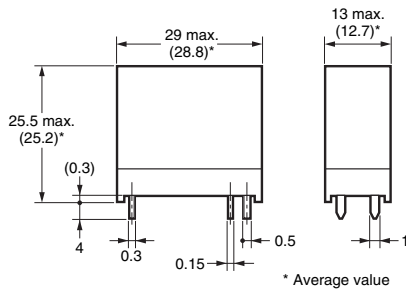

**Relays with PCB Terminals
(DPDT (2c) Relays)
G2R-24(-Z)(-U)**

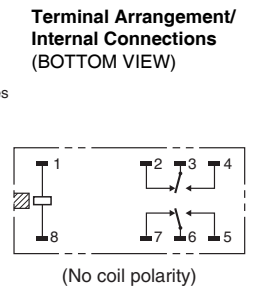
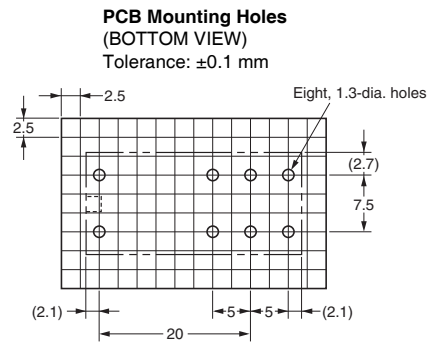
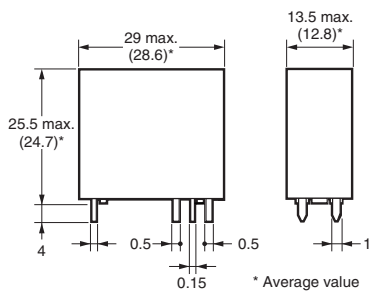

**Relays with PCB Terminals
(DPST-NO (2a) Relays)
G2R-2A4(-Z)(-U)**

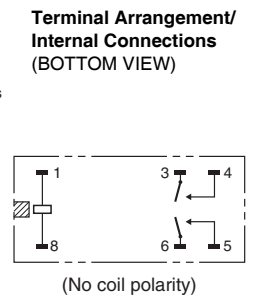
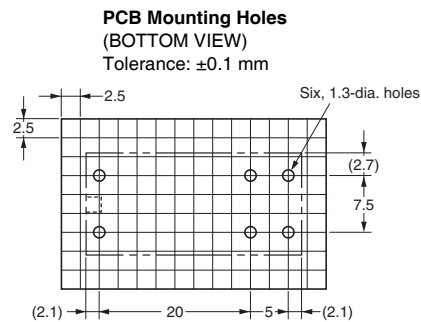
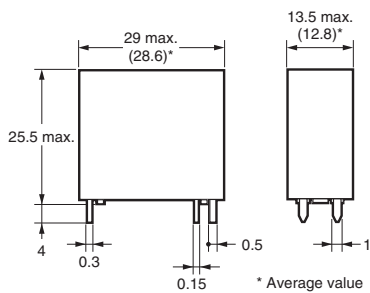

Note: Orientation marks are indicated as follows:

**Relays with Quick-connect
Terminals
(SPDT (1c) Relays)
G2R-1-T**



**Mounting Holes
(BOTTOM VIEW)**
Tolerance: ± 0.1 mm



Note: Model number of quick-connect terminal is 187.

**Terminal Arrangement/
Internal Connections
(BOTTOM VIEW)**



**Relays with Quick-connect
Terminals
(SPST-NO (1a) Relays)
G2R-1A-T**



**Mounting Holes
(BOTTOM VIEW)**
Tolerance: ± 0.1 mm



Note: Model number of quick-connect terminal is 187.

**Terminal Arrangement/
Internal Connections
(BOTTOM VIEW)**



G
2
R

Note: Orientation marks are indicated as follows:

Approved Standards

- The approval rating values for overseas standards are different from the performance values determined individually. Confirm the values before use.

UL Recognized:  File No. E41643

1-pole

| Model | Contact form | Coil ratings | Contact ratings | Number of test operations |
|----------|---------------------------|-------------------------------|-------------------------------------|----------------------------------|
| G2R-1A | SPST-NO (1a) | 5 to 110 VDC 12 to 220 VAC | 10 A, 250 VAC (General Use) at 40°C | 100,000 |
| G2R-1A4 | | | 5 A, 277 VAC (General Use) at 40°C | 6,000 |
| G2R-1A-H | | | 5 A, 30 VDC (Resistive) at 40°C | 100,000 |
| G2R-1A-T | | | | 25,000 |
| G2R-1 | SPDT (1c) | 5 to 110 VDC 12 to 220 VAC | 5 A, 30 VDC (Resistive) at 40°C | 100,000 |
| G2R-14 | | | TV-3 (N. O. only) at 40°C | 25,000 |
| G2R-1-H | | | | 6,000 |
| G2R-1-T | | | | |
| G2R-1AZ | SPST-NO (1a) | 5 to 110 VDC 12 to 220 VAC | 10 A, 250 VAC (General Use) at 40°C | 6,000 |
| G2R-1AZ4 | | | 5 A, 30 VDC (Resistive) at 40°C | |
| G2R-1Z | | | SPDT (1c) | 6,000 |
| G2R-1Z4 | | | | |
| G2R-1A-E | SPST-NO (1a) | 5 to 110 VDC 12 to 220 VAC | 16 A, 250 VAC (General Use) at 40°C | 30,000 |
| G2R-1-E | | | SPDT (1c) | 16 A, 30 VDC (Resistive) at 40°C |
| | TV-3 (N. O. only) at 40°C | 25,000 | | |

2-pole

| Model | Contact form | Coil ratings | Contact ratings | Number of test operations |
|----------|--------------|-------------------------------|------------------------------------|---------------------------|
| G2R-2A | DPST-NO (2a) | 5 to 110 VDC 12 to 220 VAC | 5 A, 250 VAC (General Use) at 40°C | 6,000 |
| G2R-2A4 | | | 5 A, 30 VDC (Resistive) at 40°C | 100,000 |
| G2R-2A-H | | | | |
| G2R-2 | DPDT (2c) | 5 to 110 VDC 12 to 220 VAC | 5 A, 30 VDC (Resistive) at 40°C | 100,000 |
| G2R-24 | | | TV-3 (N. O. only) at 40°C | 25,000 |
| G2R-24-H | | | | |

CSA Certified:  File No. LR31928

1-pole

| Model | Contact form | Coil ratings | Contact ratings | Number of test operations |
|----------|--------------|-------------------------------|-------------------------------------|---------------------------|
| G2R-1A | SPST-NO (1a) | 5 to 110 VDC 12 to 220 VAC | 10 A, 250 VAC (General Use) at 40°C | 100,000 |
| G2R-1A4 | | | 10 A, 30 VDC (Resistive) at 40°C | 100,000 |
| G2R-1A-H | | | | TV-3 (N. O. only) at 40°C |
| G2R-1A-T | | | | |
| G2R-1 | SPDT (1c) | 5 to 110 VDC 12 to 220 VAC | 10 A, 30 VDC (Resistive) at 40°C | 100,000 |
| G2R-14 | | | TV-3 (N. O. only) at 40°C | 25,000 |
| G2R-1-H | | | | 6,000 |
| G2R-1-T | | | | |
| G2R-1AZ | SPST-NO (1a) | 5 to 110 VDC 12 to 220 VAC | 5 A, 250 VAC (General Use) at 40°C | 6,000 |
| G2R-1AZ4 | | | 5 A, 30 VDC (Resistive) at 40°C | |
| G2R-1Z | | | SPDT (1c) | 6,000 |
| G2R-1Z4 | SPST-NO (1a) | 5 to 110 VDC 12 to 220 VAC | 16 A, 250 VAC (General Use) at 40°C | 6,000 |
| G2R-1A-E | | | 16 A, 30 VDC (Resistive) at 40°C | |
| G2R-1-E | SPDT (1c) | 5 to 110 VDC 12 to 220 VAC | TV-3 (N. O. only) at 40°C | 25,000 |

2-pole

| Model | Contact form | Coil ratings | Contact ratings | Number of test operations |
|----------|--------------|-------------------------------|------------------------------------|---------------------------|
| G2R-2A | DPST-NO (2a) | 5 to 110 VDC 12 to 220 VAC | 5 A, 250 VAC (General Use) at 40°C | 6,000 |
| G2R-2A4 | | | 5 A, 30 VDC (Resistive) at 40°C | 100,000 |
| G2R-2A-H | | | | |
| G2R-2 | DPDT (2c) | 5 to 110 VDC 12 to 220 VAC | 5 A, 30 VDC (Resistive) at 40°C | 100,000 |
| G2R-24 | | | TV-3 (N. O. only) at 40°C | 25,000 |
| G2R-24-H | | | | |

EN/IEC, VDE Certified: Certificate No. 40015012

| Model | Contact form | Coil ratings | Contact ratings | Number of test operations |
|------------|--------------|---|------------------------------------|---------------------------|
| G2R-1(A)-E | 1 | 5, 6, 12, 24, 48, 100 VDC 12, 24, 100/110, 200/220 VAC | 16 A, 250 VAC (cosφ = 1.0) at 70°C | 100,000 |
| G2R-() | 1 | 5, 6, 12, 24, 48, 100 VDC 12, 24, 100/110, 200/220 VAC | 10 A, 250 VAC (cosφ = 1.0) at 40°C | |
| | | | 10 A, 30 VDC (0 ms) at 40°C | |
| | 2 | | 5 A, 250 VAC (cosφ = 1.0) at 40°C | |
| | | | 5 A, 30 VDC (0 ms) at 40°C | |

EN, TÜV Certified: Registration No. R50030327

| Model | Contact form | Coil ratings | Contact ratings | Number of test operations |
|------------|--------------|-------------------------------|------------------------------------|---------------------------|
| G2R-1(A)-E | 1 | 5 to 110 VDC 12 to 220 VAC | 16 A, 250 VAC (cosφ = 1.0) at 70°C | 100,000 |
| G2R-() | 1 | 5 to 110 VDC 12 to 220 VAC | 10 A, 250 VAC (cosφ = 1.0) at 70°C | |
| | | | 10 A, 30 VDC (0 ms) at 70°C | |
| | 2 | | 5 A, 250 VAC (cosφ = 1.0) at 40°C | |
| | | | 5 A, 30 VDC (0 ms) at 40°C | |

■Precautions

● Please refer to “PCB Relays Common Precautions” for correct use.

Correct Use

● Mounting

- When mounting a number of relays on a PCB, be sure to provide a minimum mounting space of 5 mm between the two juxtaposed relays as shown below.



● Handling

- The terminals are compatible with Faston receptacle #187 and are suitable for positive-lock mounting. Use only Faston terminals with the specified numbers. Select leads for connecting Faston receptacles with wire diameters that are within the allowable range for the load current. Do not apply excessive force to the terminals when mounting or dismantling the Faston receptacle. Also, do not insert terminals at an angle, or insert/remove multiple terminals at the same time. Be sure to insert and remove terminals carefully one at a time.

Refer to the following table for examples of positive-lock connectors made by AMP. Contact the manufacturer directly for details on connectors including availability.

| Type | Receptacle terminals | Positive housing |
|-------------------------|---------------------------|--------------------------------|
| #187 (Width 4.75) | AMP170330-1 (170324-1) | AMP172074-1 (natural color) |
| | AMP170331-1 (170325-1) | AMP172074-4 (yellow) |
| | AMP170332-1 (170326-1) | AMP172074-5 (green) |
| | | AMP172074-6 (blue) |

Note: The numbers shown in parentheses are for air-feeding.

● Minimum Pulse Width of Double-winding Latching Relays

- The minimum pulse width shown in the table of characteristics are values measured under conditions of ambient temperature at 23°C with rated operating voltage imposed on coil. The Relay may not provide a satisfactory performance as its holding ability decreases depending on the operating circuit conditions and ambient temperature, or decreases due to degradation over time. In actual operation, impose to the coil a rated operating voltage with a pulse width that is suitable to the actual load, and reset the setting at least once a year, to correspond to the degradation over time.
- When using the Relay in a strong magnetic field environment, the magnetic body may be demagnetized due to the influence of environment, causing the Relay to malfunction.

Therefore, do not use the Relay in a strong magnetic field environment.

● Degradation over Time of Double-winding Latching Relays Holding Ability

- If a double-winding latching Relay is used left set for an extended period, changes over time will degrade the magnetic force, and the reduction in holding ability may cause the set status to be released. This is also because of the properties of semi-hard magnetic material, and the rate of degradation over time depends on the ambient environment (e.g., temperature, humidity, vibration, and presence or absence of external magnetic fields). Perform maintenance at least once a year by resetting, applying the rated voltage again, and then setting.
- Wiring High Capacity (-E) Models**
 - High-capacity models (-E) have a structure that connects two terminals from one contact. When designing the circuit, use both terminals. If you use only one terminal, the relay may be unable to satisfy specified performance.

· Application examples provided in this document are for reference only. In actual applications, confirm equipment functions and safety before using the product.
 · Consult your OMRON representative before using the product under conditions which are not described in the manual or applying the product to nuclear control systems, railroad systems, aviation systems, vehicles, combustion systems, medical equipment, amusement machines, safety equipment, and other systems or equipment that may have a serious influence on lives and property if used improperly. Make sure that the ratings and performance characteristics of the product provide a margin of safety for the system or equipment, and be sure to provide the system or equipment with double safety mechanisms.

Note: Do not use this document to operate the Unit.

Mouser Electronics

Authorized Distributor

Click to View Pricing, Inventory, Delivery & Lifecycle Information:

Omron:

[G2R-1E-AC120](#) [G2R-2-DC12](#) [G2R-1A-E-T130-DC24](#) [G2R-1-E-DC5](#) [G2R-14-DC5](#) [G2R-1A-DC24](#) [G2R-2A-DC12](#)
[G2R-24-DC12](#) [G2R-14-DC12](#) [G2R-24-AC220](#) [G2R-14-AC24](#) [G2R-1A-E-DC12](#) [G2R-1A-E-DC24](#) [G2R-24-AC24](#)
[G2R-2-AC120](#) [G2R-24-AC120](#) [G2R-14-AC120](#) [G2R-1A-T-AC24](#) [G2R-2-DC24](#) [G2R-1-E-DC24](#) [G2R-1-DC24](#) [G2R-1-](#)
[DC12](#) [G2R-1A4-AC120](#) [G2R-24-DC24](#) [G2R-14-DC24](#) [G2R-1-E-DC12](#) [G2R-1A4-DC24](#) [G2R-24-DC5](#) [G2R-1-DC110](#)
[G2R-1-AC220](#) [G2R-1-ASI-DC12](#) [G2R-1-DC48](#) [G2R-1-DC5](#) [G2R-1-DC6](#) [G2R-1-E-AC24](#) [G2R-1-E-AC240](#) [G2R-1-](#)
[E-ASI-DC12](#) [G2R-1-E-ASI-DC24](#) [G2R-1-E-ASI-T130 DC12](#) [G2R-1-E-DC48](#) [G2R-1-E-T130 DC24](#) [G2R-1-H-DC12](#)
[G2R-1-H-DC24](#) [G2R-1-H-DC5](#) [G2R-1-H-DC6](#) [G2R-1-H-T130 DC12](#) [G2R-1-T-AC120](#) [G2R-1-T-AC240](#) [G2R-1-T130](#)
[DC24](#) [G2R-1A-AC24](#) [G2R-1A-AC240](#) [G2R-1A-DC12](#) [G2R-1A-DC48](#) [G2R-1A-DC5](#) [G2R-1A-DC6](#) [G2R-1A-E AC240](#)
[G2R-1A-E-AC120](#) [G2R-1A-E-DC5](#) [G2R-1A-H-DC12](#) [G2R-1A-H-DC5](#) [G2R-1A-H-DC6](#) [G2R-1A-H-T130 DC12](#) [G2R-](#)
[1A4-AC240](#) [G2R-1A4-ASI DC24](#) [G2R-1A4-ASI-DC12](#) [G2R-1A4-DC48](#) [G2R-1A4-DC5](#) [G2R-1A4-DC6](#) [G2R-1A4-H-](#)
[DC12](#) [G2R-1A4-H-DC6](#) [G2R-1A4-T130 DC12](#) [G2R-1A4-T130 DC24](#) [G2R-14 DC6](#) [G2R-14-ASI-DC12](#) [G2R-14-ASI-](#)
[DC24](#) [G2R-14-H-DC12](#) [G2R-14-H-DC24](#) [G2R-14-T130 DC12](#) [G2R-2-AC240](#) [G2R-2-ASI-DC24](#) [G2R-2-DC48](#) [G2R-](#)
[2-DC5](#) [G2R-2-H-DC12](#) [G2R-2-H-DC24](#) [G2R-2-H-DC48](#) [G2R-2-H-DC5](#) [G2R-2-T130 DC24](#) [G2R-2A-AC120](#) [G2R-2A-](#)
[AC24](#) [G2R-2A-ASI-DC12](#) [G2R-2A-ASI-DC24](#) [G2R-2A-DC24](#) [G2R-2A-DC48](#) [G2R-2A-H-DC12](#) [G2R-2A-H-DC24](#)
[G2R-2A-H-DC5](#) [G2R-2A-T130 DC12](#) [G2R-2A-T130 DC24](#) [G2R-2A4-AC120](#) [G2R-2A4-AC24](#)



Компания «ЭлектроПласт» предлагает заключение долгосрочных отношений при поставках импортных электронных компонентов на взаимовыгодных условиях!

Наши преимущества:

- Оперативные поставки широкого спектра электронных компонентов отечественного и импортного производства напрямую от производителей и с крупнейших мировых складов;
- Поставка более 17-ти миллионов наименований электронных компонентов;
- Поставка сложных, дефицитных, либо снятых с производства позиций;
- Оперативные сроки поставки под заказ (от 5 рабочих дней);
- Экспресс доставка в любую точку России;
- Техническая поддержка проекта, помощь в подборе аналогов, поставка прототипов;
- Система менеджмента качества сертифицирована по Международному стандарту ISO 9001;
- Лицензия ФСБ на осуществление работ с использованием сведений, составляющих государственную тайну;
- Поставка специализированных компонентов (Xilinx, Altera, Analog Devices, Intersil, Interpoint, Microsemi, Aeroflex, Peregrine, Syfer, Eurofarad, Texas Instrument, Miteq, Cobham, E2V, MA-COM, Hittite, Mini-Circuits, General Dynamics и др.);

Помимо этого, одним из направлений компании «ЭлектроПласт» является направление «Источники питания». Мы предлагаем Вам помощь Конструкторского отдела:

- Подбор оптимального решения, техническое обоснование при выборе компонента;
- Подбор аналогов;
- Консультации по применению компонента;
- Поставка образцов и прототипов;
- Техническая поддержка проекта;
- Защита от снятия компонента с производства.



Как с нами связаться

Телефон: 8 (812) 309 58 32 (многоканальный)

Факс: 8 (812) 320-02-42

Электронная почта: org@eplast1.ru

Адрес: 198099, г. Санкт-Петербург, ул. Калинина, дом 2, корпус 4, литера А.