

## Features

- 0.4" (10.16mm) Matrix Height
- Single Digit Display
- Black/Grey Face , White Segment
- IC compatible, Easy assembly
- Dynamic drive connect
- RoHS Compliant, Pb Free

## Applications

- Consumer Electronics
- Industrial Equipment

## Description

The INND-SS40 series is a 0.4" single digit display. It is a SMD type LED display which can be used in various applications.

## Internal Circuit Diagram

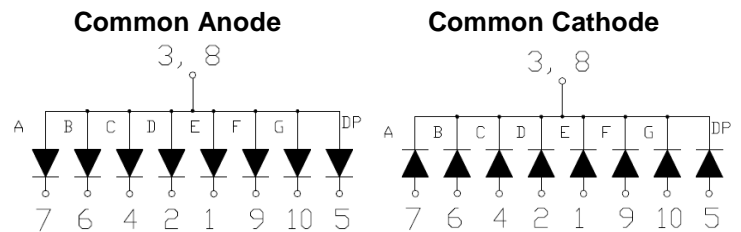

Figure 1. INND-SS40 series Internal Circuit Diagram

## Package Dimensions

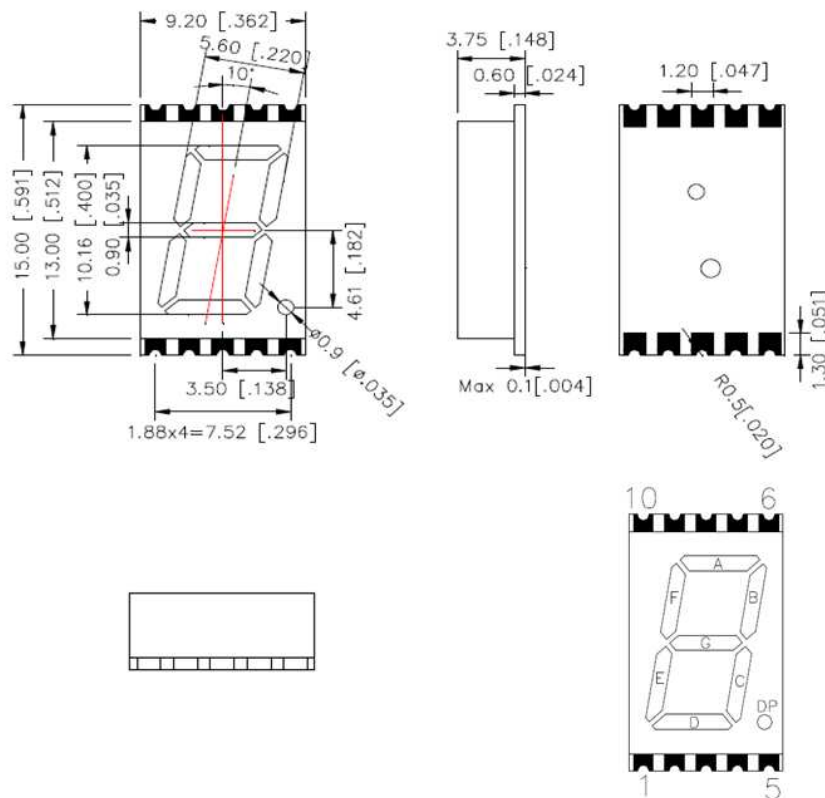

Figure 2. INND-SS40 series Package Dimensions

**Absolute Maximum Rating at 25°C** (Note 1)

Product (Per Segment)	Emission Color	Technology	P <sub>d</sub> (mW)	I <sub>F</sub> (mA)	I <sub>FP</sub> * (mA)	V <sub>R</sub> (V)	Derate From 25°C (mA/°C)	T <sub>OP</sub> (°C)	T <sub>ST</sub> (°C)
INND-SS40YGXX	Yellow Green	AlGaInP	70	25	90	5	0.33	-40 °C ~+105 °C	-40 °C ~+105 °C
INND-SS40YXX	Yellow	AlGaInP	70	25	90	5	0.33	-40 °C ~+105 °C	-40 °C ~+105 °C
INND-SS40AXX	Amber	AlGaInP	70	25	90	5	0.33	-40 °C ~+105 °C	-40 °C ~+105 °C
INND-SS40RXX	Red	AlGaInP	70	25	90	5	0.33	-40 °C ~+105 °C	-40 °C ~+105 °C
INND-SS40DRXX	Deep Red	AlGaInP	70	25	90	5	0.33	-40 °C ~+105 °C	-40 °C ~+105 °C
INND-SS40GXX	Green	InGaN	114	30	100	5	0.4	-40 °C ~+105 °C	-40 °C ~+105 °C
INND-SS40BXX	Blue	InGaN	114	30	100	5	0.4	-40 °C ~+105 °C	-40 °C ~+105 °C
INND-SS40WXX	White	InGaN	114	30	100	5	0.4	-40 °C ~+105 °C	-40 °C ~+105 °C

**Notes**

1. Condition for IFP is pulse of 1/10 duty and 0.1msec width

### Electrical Characteristics $T_A = 25^\circ\text{C}$ (Note 1)

Product (Per Segment)	Emission Color	$V_F(\text{V})@20\text{mA}$			$\lambda(\text{nm})@20\text{mA}$		$I_V(\text{mcd})@10\text{mA}$			$I_R(\mu\text{A})@V_R=5\text{V}$	$I_{V-M}@I_F=10\text{mA}$
		min	typ.	max	$\lambda_D$	$\lambda_P$	min	typ.	max	max	max
INND-SS40YGXX	Yellow Green	-	2.0	2.8	570	572	-	2	-	100	2:1
INND-SS40YXX	Yellow	-	2.0	2.8	590	592	-	13	-	100	2:1
INND-SS40AXX	Amber	-	2.0	2.8	605	612	-	13	-	100	2:1
INND-SS40RXX	Red	-	2.0	2.8	630	644	-	4	-	100	2:1
INND-SS40DRXX	Deep Red	-	2.0	2.8	645	660	-	4	-	100	2:1
INND-SS40GXX	Green	-	3.2	3.8	525	-	-	47	-	100	2:1
INND-SS40BXX	Blue	-	3.2	3.8	-	465	-	7	-	50	2:1
INND-SS40WXX	White	-	3.2	3.8	X: 0.27 Y: 0.25	-	-	30	-	50	2:1

### Notes

- Performance guaranteed only under conditions listed in above tables.

### ESD Precaution

ATTENTION: Electrostatic Discharge (ESD) protection



The symbol above denotes that ESD precaution is needed. ESD protection for GaP and AlGaAs based chips is necessary even though they are relatively safe in the presence of low static-electric discharge. Parts built with AlInGaP, GaN, or/and InGaN based chips are STATIC SENSITIVE devices. ESD precaution must be taken during design and assembly. If manual work or processing is needed, please ensure the device is adequately protected from ESD during the process.

Please be advised that normal static precautions should be taken in the handling and assembly of this device to prevent damage or degradation which may be induced by electrostatic discharge (ESD).

**Characteristic Curves for YG, Y, A, R, DR, G**

Fig 1. Forward Current vs. Forward Voltage



Fig 2. Relative Intensity vs. Forward Current

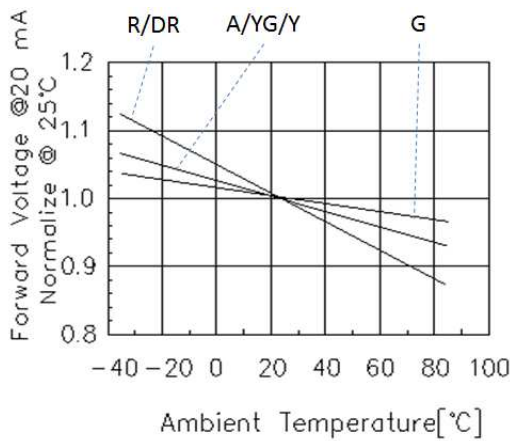

Fig 3. Forward Voltage vs. Temperature



Fig 4. Relative Intensity vs. Temperature

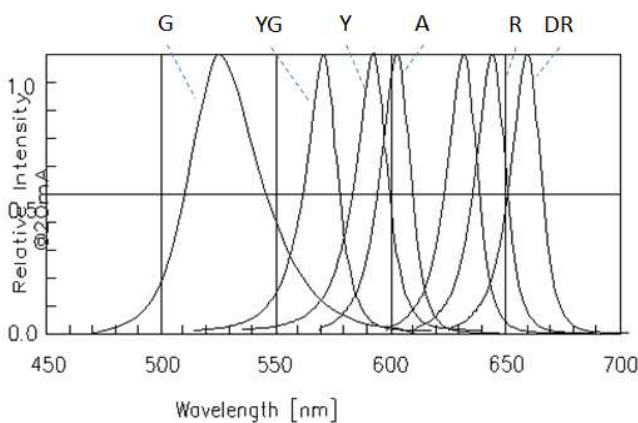

Fig 5. Relative Intensity vs. Wavelength



Fig 6. Forward current vs. Temperature

### Characteristic Curves for B



Fig 1. Forward Current vs. Forward Voltage



Fig 2. Relative Intensity vs. Forward Current



Fig 3. Forward Voltage vs. Temperature

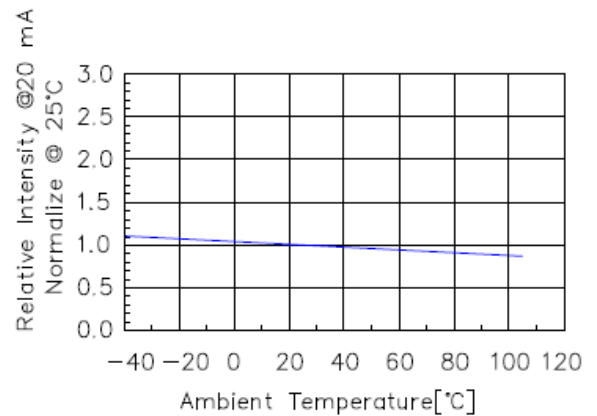

Fig 4. Relative Intensity vs. Temperature



Fig 5. Relative Intensity vs. Wavelength



Fig 6. Forward current vs. Temperature

### Characteristic Curves for W



Fig 1. Forward Current vs. Forward Voltage



Fig 2. Relative Intensity vs. Forward Current



Fig 3. Forward Voltage vs. Temperature



Fig 4. Relative Intensity vs. Temperature

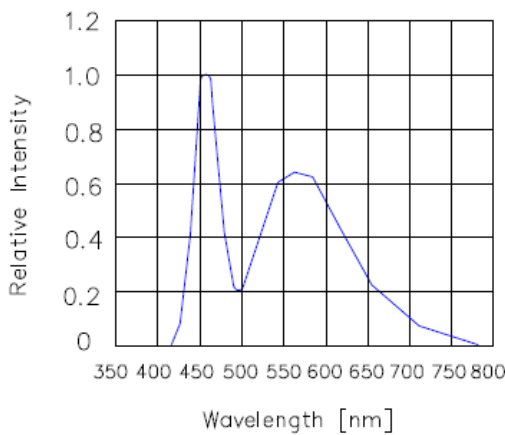
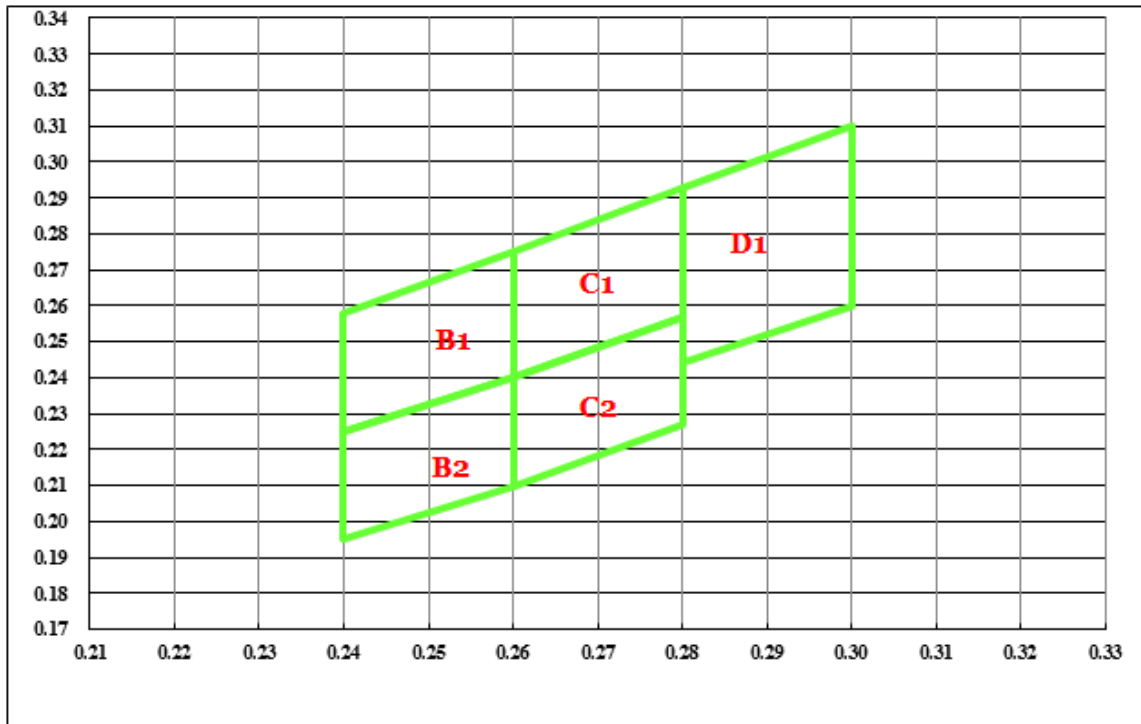

Fig 5. Relative Intensity vs. Wavelength



Fig 6. Forward current vs. Temperature

**Chromaticity Bin (for White only)**

B1				
X	0.240	0.240	0.260	0.260
Y	0.225	0.258	0.275	0.240

B2				
X	0.240	0.240	0.260	0.260
Y	0.195	0.225	0.240	0.210

C1				
X	0.260	0.260	0.280	0.280
Y	0.240	0.275	0.293	0.257

C2				
X	0.260	0.260	0.280	0.280
Y	0.210	0.240	0.257	0.227

D1				
X	0.280	0.280	0.300	0.300
Y	0.244	0.293	0.310	0.260

**Ordering Information**

Product	Emission Color	Technology	I*V(mcd) @10mA	VF(V) @20mA	Polarity	Face Color	Orderable Part Number
INND-SS40YGXX	Yellow Green	AlGaInP	2	2.0	Common Anode	Black	INND-SS40YGAB
					Common Cathode	Black	INND-SS40YGCB
					Common Anode	Grey	INND-SS40YGAG
					Common Cathode	Grey	INND-SS40YGCG
INND-SS40YXX	Yellow	AlGaInP	13	2.0	Common Anode	Black	INND-SS40YAB
					Common Cathode	Black	INND-SS40YCB
					Common Anode	Grey	INND-SS40YAG
					Common Cathode	Grey	INND-SS40YCG
INND-SS40AXX	Amber	AlGaInP	13	2.0	Common Anode	Black	INND-SS40AAB
					Common Cathode	Black	INND-SS40ACB
					Common Anode	Grey	INND-SS40AAG
					Common Cathode	Grey	INND-SS40ACG
INND-SS40RXX	Red	AlGaInP	4	2.0	Common Anode	Black	INND-SS40RAB
					Common Cathode	Black	INND-SS40RCB
					Common Anode	Grey	INND-SS40RAG
					Common Cathode	Grey	INND-SS40RCG



Product	Emission Color	Technology	I*V(mcd) @10mA	VF(V) @20mA	Polarity	Face Color	Orderable Part Number
INND-SS40DRXX	Deep Red	AlGaInP	4	2.0	Common Anode	Black	INND-SS40DRAB
					Common Cathode	Black	INND-SS40DRCB
					Common Anode	Grey	INND-SS40DRAG
					Common Cathode	Grey	INND-SS40DRCG
INND-SS40GXX	Green	InGaN	47	3.2	Common Anode	Black	INND-SS40GAB
					Common Cathode	Black	INND-SS40GCB
					Common Anode	Grey	INND-SS40GAG
					Common Cathode	Grey	INND-SS40GCG
INND-SS40BXX	Blue	InGaN	7	3.2	Common Anode	Black	INND-SS40BAB
					Common Cathode	Black	INND-SS40BCB
					Common Anode	Grey	INND-SS40BAG
					Common Cathode	Grey	INND-SS40BCG
INND-SS40WXX	White	InGaN	30	3.2	Common Anode	Black	INND-SS40WAB
					Common Cathode	Black	INND-SS40WCB
					Common Anode	Grey	INND-SS40WAG
					Common Cathode	Grey	INND-SS40WCG

**Label Specifications**

**Inolux P/N:**

I	N	N	D	-	S	S	4	0	X	X	X	-	X	X	X	X
Inolux	Display Type		Display Type		Dimension		Color		Polarity		Face Color		Customized Stamp-off			
	ND = Numeric Display		S: SMD Type S: Single		40 = 0.40" Display Height		YG: 570 nm Y: 590 nm A: 605 nm R: 630 nm DR: 660 nm G: 525 nm B: 465 nm W: X: 0.27 Y: 0.25		A = Common Anode  C=Common Cathode		B = Black G = Grey					

**Lot No.:**

Z	2	0	1	7	01	24	001
Internal Tracker	Year (2017, 2018, .....)				Month	Date	Serial

## Reflow Soldering



## Soldering Iron

Basic Spec is  $\leq 4$  sec. when 260°C (+10°C → -1 second). Power dissipation of Iron should be less than 15W. Surface temperature should be under 230°C

## Rework

Rework should be completed within 4 second under 245°C

## Revision History

Changes since last revision	Page	Version No.	Revision Date
Initial Release		1.0	07-12-2017

## DISCLAIMER

INOLUX reserves the right to make changes without further notice to any products herein to improve reliability, function or design. INOLUX does not assume any liability arising out of the application or use of any product or circuit described herein; neither does it convey any license under its patent rights, nor the rights of others.

## LIFE SUPPORT POLICY

INOLUX's products are not authorized for use as critical components in life support devices or systems without the express written approval of the President of INOLUX or INOLUX CORPORATION. As used herein:

1. Life support devices or systems are devices or systems which, (a) are intended for surgical implant into the body, or (b) support or sustain life, and (c) whose failure to perform when properly used in accordance with instructions for use provided in the labeling, can be reasonably expected to result in a significant injury of the user.
2. A critical component in any component of a life support device or system whose failure to perform can be reasonably expected to cause the failure of the life support device or system, or to affect its safety or effectiveness.



Компания «ЭлектроПласт» предлагает заключение долгосрочных отношений при поставках импортных электронных компонентов на взаимовыгодных условиях!

Наши преимущества:

- Оперативные поставки широкого спектра электронных компонентов отечественного и импортного производства напрямую от производителей и с крупнейших мировых складов;
- Поставка более 17-ти миллионов наименований электронных компонентов;
- Поставка сложных, дефицитных, либо снятых с производства позиций;
- Оперативные сроки поставки под заказ (от 5 рабочих дней);
- Экспресс доставка в любую точку России;
- Техническая поддержка проекта, помощь в подборе аналогов, поставка прототипов;
- Система менеджмента качества сертифицирована по Международному стандарту ISO 9001;
- Лицензия ФСБ на осуществление работ с использованием сведений, составляющих государственную тайну;
- Поставка специализированных компонентов (Xilinx, Altera, Analog Devices, Intersil, Interpoint, Microsemi, Aeroflex, Peregrine, Syfer, Eurofarad, Texas Instrument, Miteq, Cobham, E2V, MA-COM, Hittite, Mini-Circuits, General Dynamics и др.);

Помимо этого, одним из направлений компании «ЭлектроПласт» является направление «Источники питания». Мы предлагаем Вам помощь Конструкторского отдела:

- Подбор оптимального решения, техническое обоснование при выборе компонента;
- Подбор аналогов;
- Консультации по применению компонента;
- Поставка образцов и прототипов;
- Техническая поддержка проекта;
- Защита от снятия компонента с производства.



#### Как с нами связаться

**Телефон:** 8 (812) 309 58 32 (многоканальный)

**Факс:** 8 (812) 320-02-42

**Электронная почта:** [org@eplast1.ru](mailto:org@eplast1.ru)

**Адрес:** 198099, г. Санкт-Петербург, ул. Калинина, дом 2, корпус 4, литера А.