

Features

- 0.4" (10.16mm) Matrix Height
- Single Digit Display
- Black/Grey Face , White Segment
- IC compatible, Easy assembly
- Dynamic drive connect
- RoHS Compliant, Pb Free

Applications

- Consumer Electronics
- Industrial Equipment

Description

The INND-SS40 series is a 0.4" single digit display. It is a SMD type LED display which can be used in various applications.

Internal Circuit Diagram

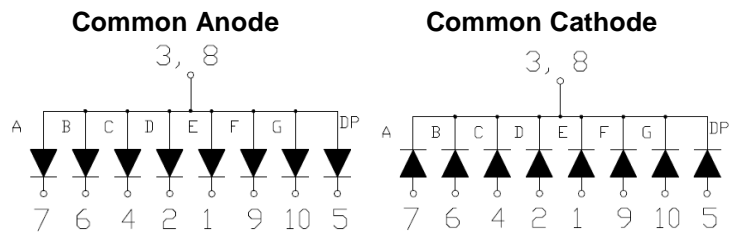


Figure 1. INND-SS40 series Internal Circuit Diagram

Package Dimensions

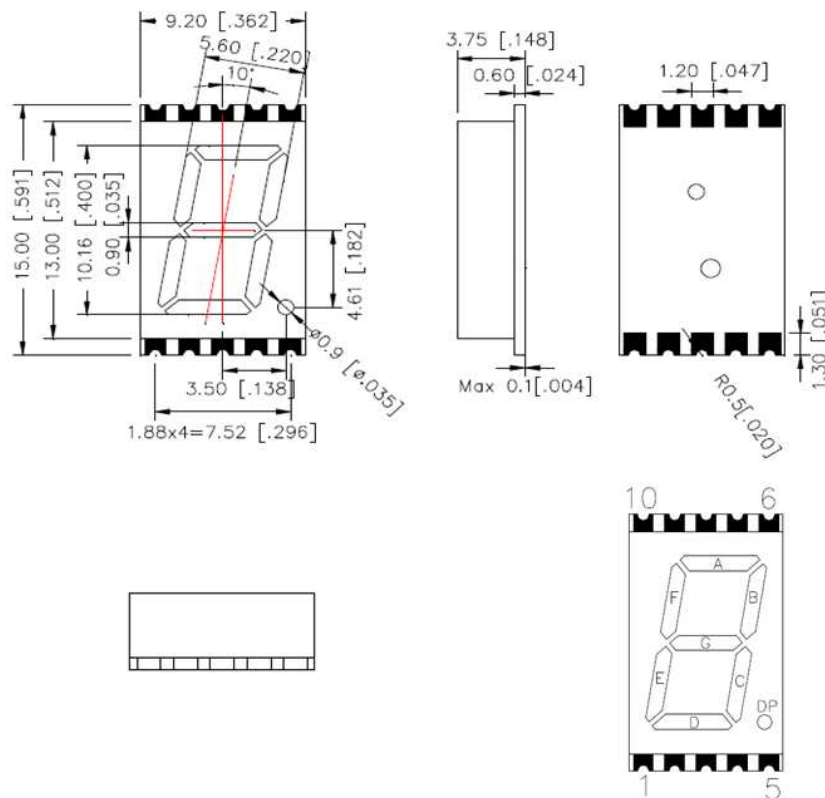


Figure 2. INND-SS40 series Package Dimensions

Absolute Maximum Rating at 25°C (Note 1)

| Product (Per Segment) | Emission Color | Technology | P _d (mW) | I _F (mA) | I _{FP} * (mA) | V _R (V) | Derate From 25°C (mA/°C) | T _{OP} (°C) | T _{ST} (°C) |
|--------------------------|-------------------|------------|---------------------|---------------------|------------------------|--------------------|-----------------------------|----------------------|----------------------|
| INND-SS40YGXX | Yellow Green | AlGaInP | 70 | 25 | 90 | 5 | 0.33 | -40 °C ~+105 °C | -40 °C ~+105 °C |
| INND-SS40YXX | Yellow | AlGaInP | 70 | 25 | 90 | 5 | 0.33 | -40 °C ~+105 °C | -40 °C ~+105 °C |
| INND-SS40AXX | Amber | AlGaInP | 70 | 25 | 90 | 5 | 0.33 | -40 °C ~+105 °C | -40 °C ~+105 °C |
| INND-SS40RXX | Red | AlGaInP | 70 | 25 | 90 | 5 | 0.33 | -40 °C ~+105 °C | -40 °C ~+105 °C |
| INND-SS40DRXX | Deep Red | AlGaInP | 70 | 25 | 90 | 5 | 0.33 | -40 °C ~+105 °C | -40 °C ~+105 °C |
| INND-SS40GXX | Green | InGaN | 114 | 30 | 100 | 5 | 0.4 | -40 °C ~+105 °C | -40 °C ~+105 °C |
| INND-SS40BXX | Blue | InGaN | 114 | 30 | 100 | 5 | 0.4 | -40 °C ~+105 °C | -40 °C ~+105 °C |
| INND-SS40WXX | White | InGaN | 114 | 30 | 100 | 5 | 0.4 | -40 °C ~+105 °C | -40 °C ~+105 °C |

Notes

1. Condition for IFP is pulse of 1/10 duty and 0.1msec width

Electrical Characteristics $T_A = 25^\circ\text{C}$ (Note 1)

| Product (Per Segment) | Emission Color | $V_F(\text{V})@20\text{mA}$ | | | $\lambda(\text{nm})@20\text{mA}$ | | $I_V(\text{mcd})@10\text{mA}$ | | | $I_R(\mu\text{A})@V_R=5\text{V}$ | $I_{V-M}@I_F=10\text{mA}$ |
|--------------------------|-------------------|-----------------------------|------|-----|----------------------------------|-------------|-------------------------------|------|-----|----------------------------------|---------------------------|
| | | min | typ. | max | λ_D | λ_P | min | typ. | max | max | max |
| INND-SS40YGXX | Yellow Green | - | 2.0 | 2.8 | 570 | 572 | - | 2 | - | 100 | 2:1 |
| INND-SS40YXX | Yellow | - | 2.0 | 2.8 | 590 | 592 | - | 13 | - | 100 | 2:1 |
| INND-SS40AXX | Amber | - | 2.0 | 2.8 | 605 | 612 | - | 13 | - | 100 | 2:1 |
| INND-SS40RXX | Red | - | 2.0 | 2.8 | 630 | 644 | - | 4 | - | 100 | 2:1 |
| INND-SS40DRXX | Deep Red | - | 2.0 | 2.8 | 645 | 660 | - | 4 | - | 100 | 2:1 |
| INND-SS40GXX | Green | - | 3.2 | 3.8 | 525 | - | - | 47 | - | 100 | 2:1 |
| INND-SS40BXX | Blue | - | 3.2 | 3.8 | - | 465 | - | 7 | - | 50 | 2:1 |
| INND-SS40WXX | White | - | 3.2 | 3.8 | X: 0.27 Y: 0.25 | - | - | 30 | - | 50 | 2:1 |

Notes

1. Performance guaranteed only under conditions listed in above tables.

ESD Precaution

ATTENTION: Electrostatic Discharge (ESD) protection



The symbol above denotes that ESD precaution is needed. ESD protection for GaP and AlGaAs based chips is necessary even though they are relatively safe in the presence of low static-electric discharge. Parts built with AlInGaP, GaN, or/and InGaN based chips are STATIC SENSITIVE devices. ESD precaution must be taken during design and assembly.

If manual work or processing is needed, please ensure the device is adequately protected from ESD during the process.

Please be advised that normal static precautions should be taken in the handling and assembly of this device to prevent damage or degradation which may be induced by electrostatic discharge (ESD).

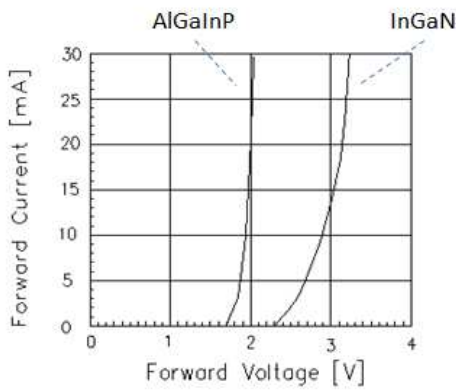
Characteristic Curves for YG, Y, A, R, DR, G


Fig 1. Forward Current vs. Forward Voltage

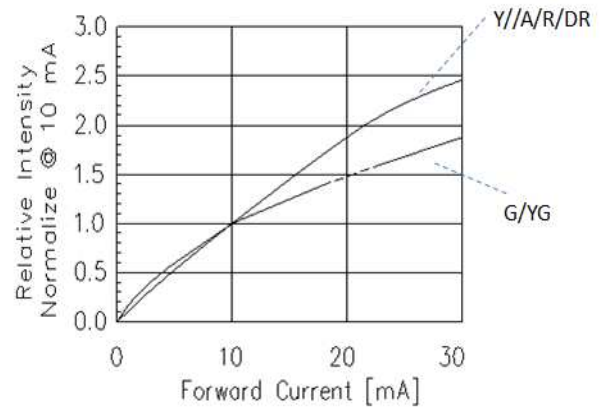


Fig 2. Relative Intensity vs. Forward Current

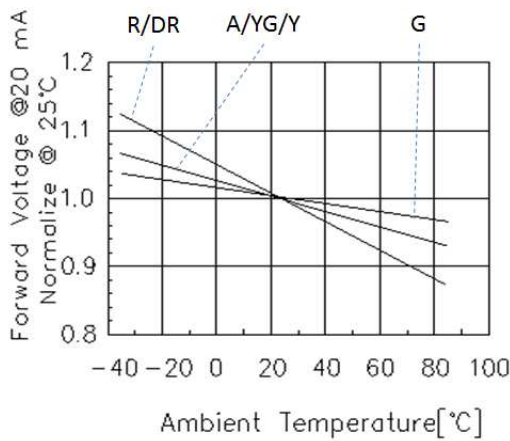


Fig 3. Forward Voltage vs. Temperature

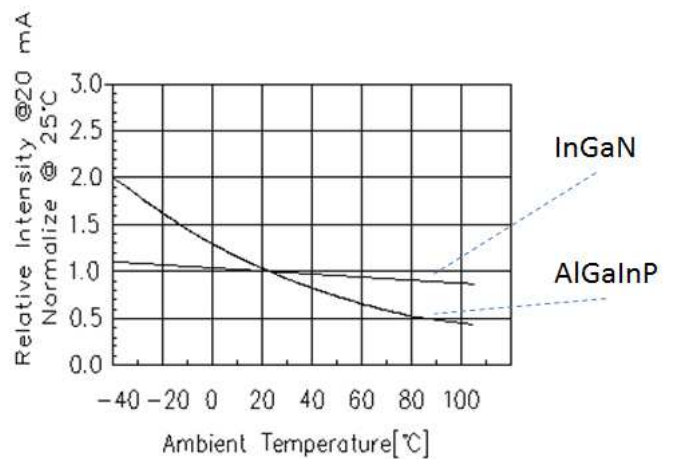


Fig 4. Relative Intensity vs. Temperature

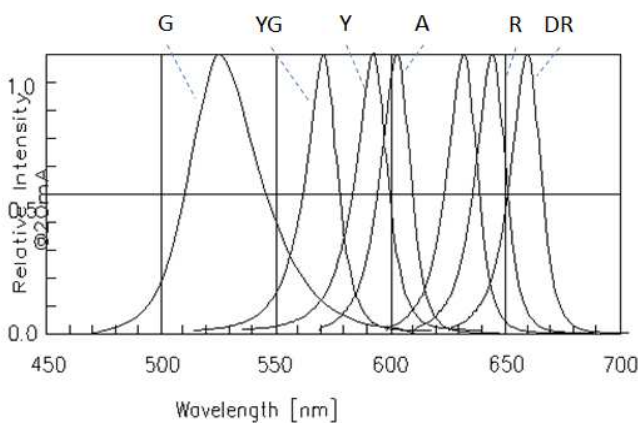


Fig 5. Relative Intensity vs. Wavelength

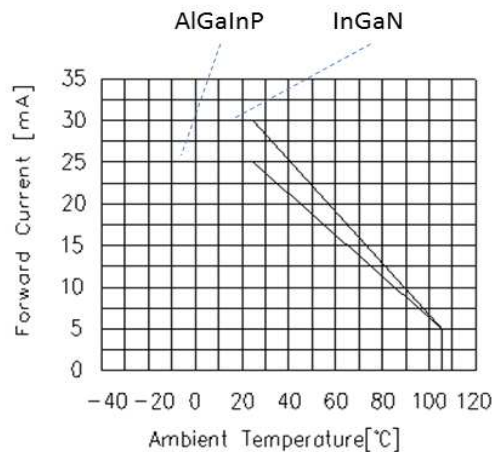


Fig 6. Forward current vs. Temperature

Characteristic Curves for B

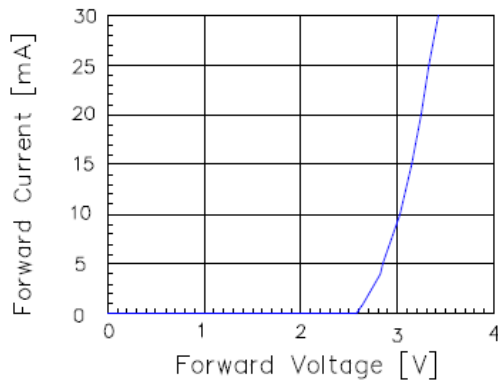


Fig 1. Forward Current vs. Forward Voltage

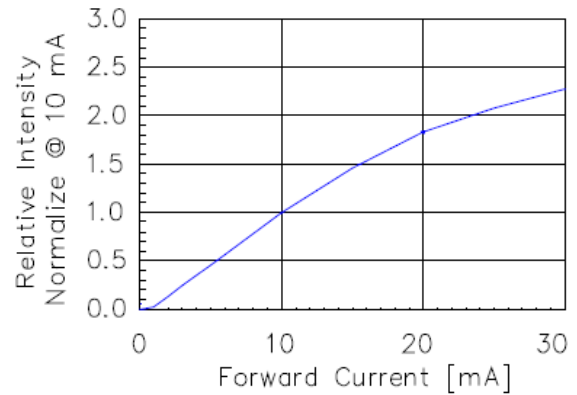


Fig 2. Relative Intensity vs. Forward Current

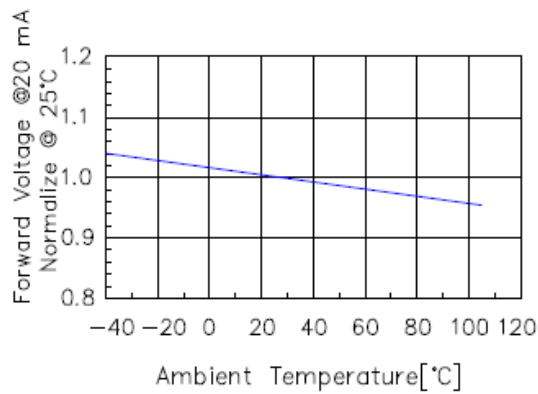


Fig 3. Forward Voltage vs. Temperature

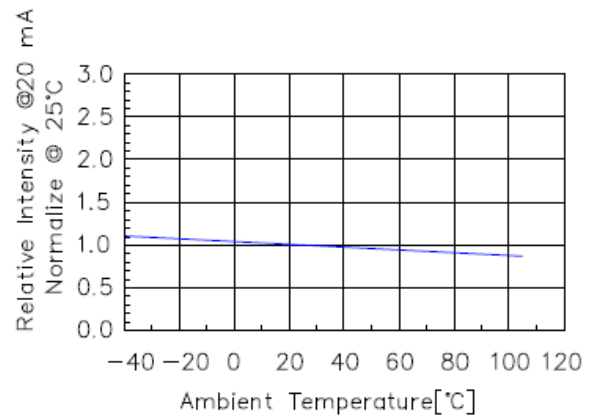


Fig 4. Relative Intensity vs. Temperature

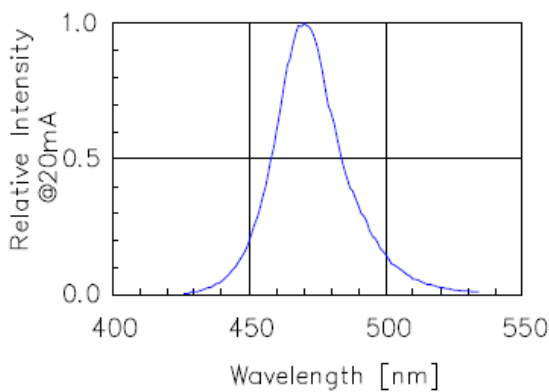


Fig 5. Relative Intensity vs. Wavelength

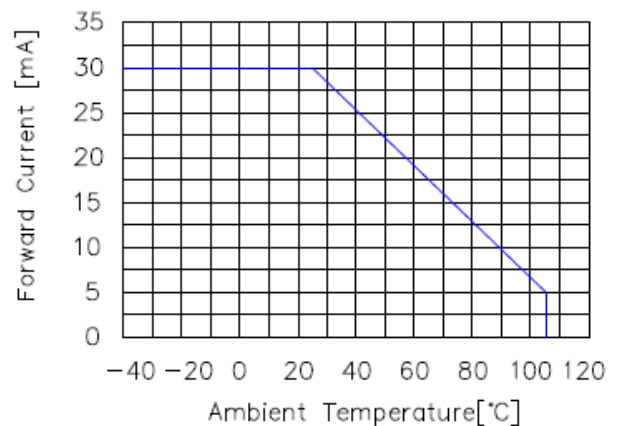


Fig 6. Forward current vs. Temperature

Characteristic Curves for W



Fig 1. Forward Current vs. Forward Voltage

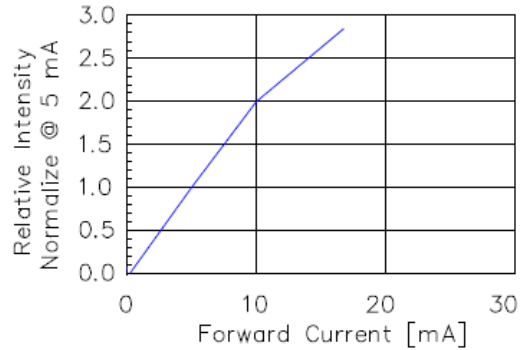


Fig 2. Relative Intensity vs. Forward Current

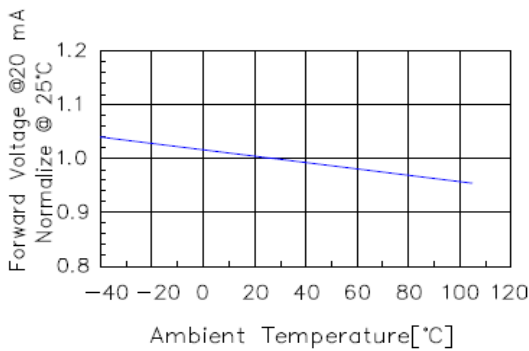


Fig 3. Forward Voltage vs. Temperature

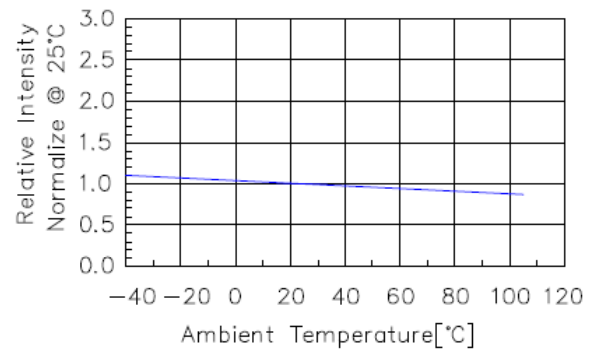


Fig 4. Relative Intensity vs. Temperature

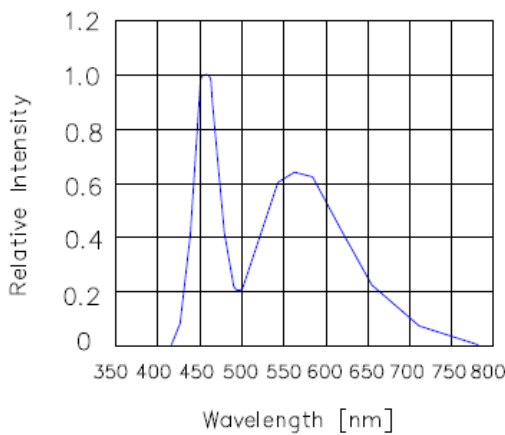


Fig 5. Relative Intensity vs. Wavelength

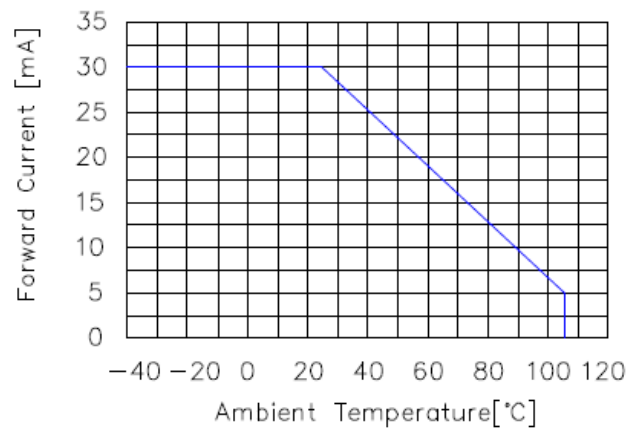
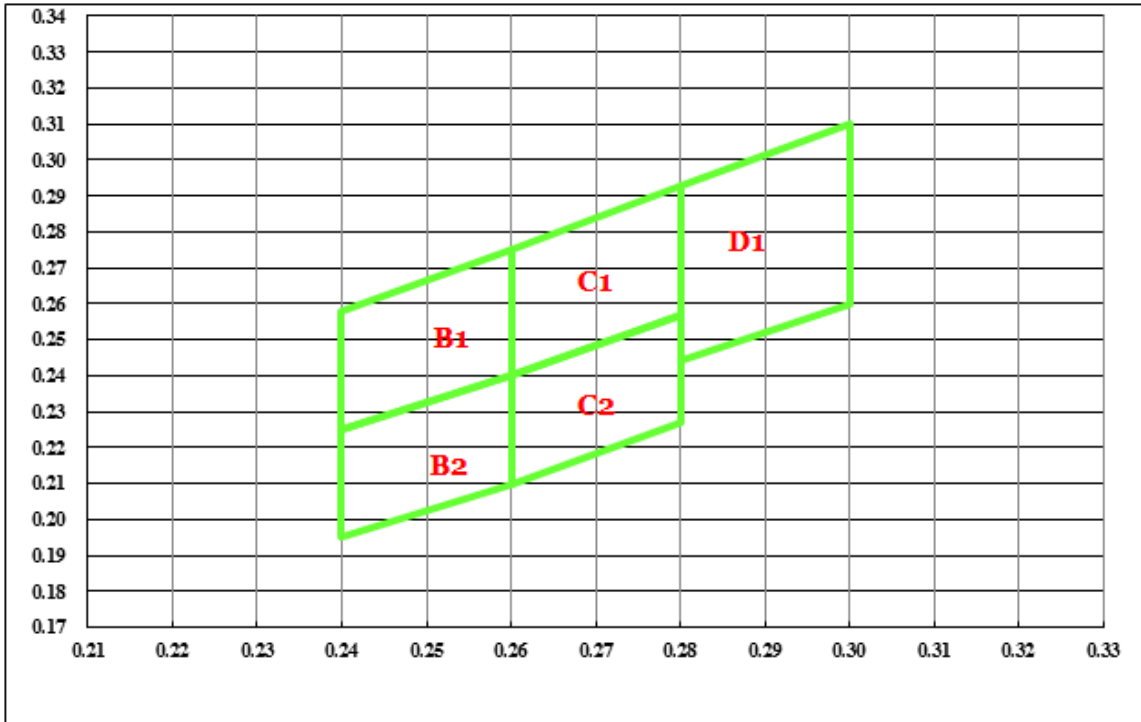


Fig 6. Forward current vs. Temperature

Chromaticity Bin (for White only)


| B1 | | | | |
|----|-------|-------|-------|-------|
| X | 0.240 | 0.240 | 0.260 | 0.260 |
| Y | 0.225 | 0.258 | 0.275 | 0.240 |

| B2 | | | | |
|----|-------|-------|-------|-------|
| X | 0.240 | 0.240 | 0.260 | 0.260 |
| Y | 0.195 | 0.225 | 0.240 | 0.210 |

| C1 | | | | |
|----|-------|-------|-------|-------|
| X | 0.260 | 0.260 | 0.280 | 0.280 |
| Y | 0.240 | 0.275 | 0.293 | 0.257 |

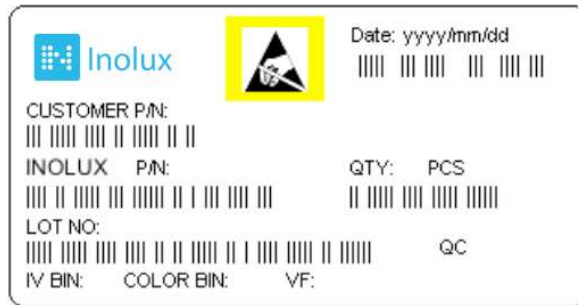
| C2 | | | | |
|----|-------|-------|-------|-------|
| X | 0.260 | 0.260 | 0.280 | 0.280 |
| Y | 0.210 | 0.240 | 0.257 | 0.227 |

| D1 | | | | |
|----|-------|-------|-------|-------|
| X | 0.280 | 0.280 | 0.300 | 0.300 |
| Y | 0.244 | 0.293 | 0.310 | 0.260 |

Ordering Information

| Product | Emission Color | Technology | I*V(mcd) @10mA | VF(V) @20mA | Polarity | Face Color | Orderable Part Number |
|---------------|----------------|------------|-------------------|----------------|----------------|------------|-----------------------|
| INND-SS40YGXX | Yellow Green | AlGaInP | 2 | 2.0 | Common Anode | Black | INND-SS40YGAB |
| | | | | | Common Cathode | Black | INND-SS40YGCB |
| | | | | | Common Anode | Grey | INND-SS40YGAG |
| | | | | | Common Cathode | Grey | INND-SS40YGCG |
| INND-SS40YXX | Yellow | AlGaInP | 13 | 2.0 | Common Anode | Black | INND-SS40YAB |
| | | | | | Common Cathode | Black | INND-SS40YCB |
| | | | | | Common Anode | Grey | INND-SS40YAG |
| | | | | | Common Cathode | Grey | INND-SS40YCG |
| INND-SS40AXX | Amber | AlGaInP | 13 | 2.0 | Common Anode | Black | INND-SS40AAB |
| | | | | | Common Cathode | Black | INND-SS40ACB |
| | | | | | Common Anode | Grey | INND-SS40AAG |
| | | | | | Common Cathode | Grey | INND-SS40ACG |
| INND-SS40RXX | Red | AlGaInP | 4 | 2.0 | Common Anode | Black | INND-SS40RAB |
| | | | | | Common Cathode | Black | INND-SS40RCB |
| | | | | | Common Anode | Grey | INND-SS40RAG |
| | | | | | Common Cathode | Grey | INND-SS40RCG |

| Product | Emission Color | Technology | I*V(mcd) @10mA | VF(V) @20mA | Polarity | Face Color | Orderable Part Number |
|---------------|----------------|------------|-------------------|----------------|----------------|------------|-----------------------|
| INND-SS40DRXX | Deep Red | AlGaInP | 4 | 2.0 | Common Anode | Black | INND-SS40DRAB |
| | | | | | Common Cathode | Black | INND-SS40DRCB |
| | | | | | Common Anode | Grey | INND-SS40DRAG |
| | | | | | Common Cathode | Grey | INND-SS40DRCG |
| INND-SS40GXX | Green | InGaN | 47 | 3.2 | Common Anode | Black | INND-SS40GAB |
| | | | | | Common Cathode | Black | INND-SS40GCB |
| | | | | | Common Anode | Grey | INND-SS40GAG |
| | | | | | Common Cathode | Grey | INND-SS40GCG |
| INND-SS40BXX | Blue | InGaN | 7 | 3.2 | Common Anode | Black | INND-SS40BAB |
| | | | | | Common Cathode | Black | INND-SS40BCB |
| | | | | | Common Anode | Grey | INND-SS40BAG |
| | | | | | Common Cathode | Grey | INND-SS40BCG |
| INND-SS40WXX | White | InGaN | 30 | 3.2 | Common Anode | Black | INND-SS40WAB |
| | | | | | Common Cathode | Black | INND-SS40WCB |
| | | | | | Common Anode | Grey | INND-SS40WAG |
| | | | | | Common Cathode | Grey | INND-SS40WCG |

Label Specifications

Inolux P/N:

| | | | | | | | | | | | | | | | | |
|--------|---|----------------------------|---|---|--------------------------|---|------------------------------|---|---|--|-----------------------|---|----------------------|---|---|---|
| I | N | N | D | - | S | S | 4 | 0 | X | X | X | - | X | X | X | X |
| Inolux | | Display Type | | | Display Type | | Dimension | | Color | Polarity | Face Color | | Customized Stamp-off | | | |
| | | ND = Numeric Display | | | S: SMD Type S: Single | | 40 = 0.40" Display Height | | YG: 570 nm Y: 590 nm A: 605 nm R: 630 nm DR: 660 nm G: 525 nm B: 465 nm W: X: 0.27 Y: 0.25 | A = Common Anode C=Common Cathode | B = Black G = Grey | | | | | |

Lot No.:

| | | | | | | | |
|------------------|--------------------------|---|---|---|-------|------|--------|
| Z | 2 | 0 | 1 | 7 | 01 | 24 | 001 |
| Internal Tracker | Year (2017, 2018,) | | | | Month | Date | Serial |

Reflow Soldering



Soldering Iron

Basic Spec is ≤ 4 sec. when 260°C (+10°C → -1 second). Power dissipation of Iron should be less than 15W. Surface temperature should be under 230°C

Rework

Rework should be completed within 4 second under 245°C

Revision History

| Changes since last revision | Page | Version No. | Revision Date |
|-----------------------------|------|-------------|---------------|
| Initial Release | | 1.0 | 07-12-2017 |
| | | | |
| | | | |
| | | | |
| | | | |
| | | | |
| | | | |
| | | | |
| | | | |

DISCLAIMER

INOLUX reserves the right to make changes without further notice to any products herein to improve reliability, function or design. INOLUX does not assume any liability arising out of the application or use of any product or circuit described herein; neither does it convey any license under its patent rights, nor the rights of others.

LIFE SUPPORT POLICY

INOLUX's products are not authorized for use as critical components in life support devices or systems without the express written approval of the President of INOLUX or INOLUX CORPORATION. As used herein:

1. Life support devices or systems are devices or systems which, (a) are intended for surgical implant into the body, or (b) support or sustain life, and (c) whose failure to perform when properly used in accordance with instructions for use provided in the labeling, can be reasonably expected to result in a significant injury of the user.
2. A critical component in any component of a life support device or system whose failure to perform can be reasonably expected to cause the failure of the life support device or system, or to affect its safety or effectiveness.



Компания «ЭлектроПласт» предлагает заключение долгосрочных отношений при поставках импортных электронных компонентов на взаимовыгодных условиях!

Наши преимущества:

- Оперативные поставки широкого спектра электронных компонентов отечественного и импортного производства напрямую от производителей и с крупнейших мировых складов;
- Поставка более 17-ти миллионов наименований электронных компонентов;
- Поставка сложных, дефицитных, либо снятых с производства позиций;
- Оперативные сроки поставки под заказ (от 5 рабочих дней);
- Экспресс доставка в любую точку России;
- Техническая поддержка проекта, помощь в подборе аналогов, поставка прототипов;
- Система менеджмента качества сертифицирована по Международному стандарту ISO 9001;
- Лицензия ФСБ на осуществление работ с использованием сведений, составляющих государственную тайну;
- Поставка специализированных компонентов (Xilinx, Altera, Analog Devices, Intersil, Interpoint, Microsemi, Aeroflex, Peregrine, Syfer, Eurofarad, Texas Instrument, Miteq, Cobham, E2V, MA-COM, Hittite, Mini-Circuits, General Dynamics и др.);

Помимо этого, одним из направлений компании «ЭлектроПласт» является направление «Источники питания». Мы предлагаем Вам помощь Конструкторского отдела:

- Подбор оптимального решения, техническое обоснование при выборе компонента;
- Подбор аналогов;
- Консультации по применению компонента;
- Поставка образцов и прототипов;
- Техническая поддержка проекта;
- Защита от снятия компонента с производства.



Как с нами связаться

Телефон: 8 (812) 309 58 32 (многоканальный)

Факс: 8 (812) 320-02-42

Электронная почта: org@eplast1.ru

Адрес: 198099, г. Санкт-Петербург, ул. Калинина, дом 2, корпус 4, литера А.