



PIC16C6X

8-Bit CMOS Microcontrollers

Devices included in this data sheet:

- PIC16C61
- PIC16C62
- PIC16C62A
- PIC16CR62
- PIC16C63
- PIC16CR63
- PIC16C64
- PIC16C64A
- PIC16CR64
- PIC16C65
- PIC16C65A
- PIC16CR65
- PIC16C66
- PIC16C67

- Low-power, high-speed CMOS EPROM/ROM technology
- Fully static design
- Wide operating voltage range: 2.5V to 6.0V
- Commercial, Industrial, and Extended temperature ranges
- Low-power consumption:
 - < 2 mA @ 5V, 4 MHz
 - 15 μ A typical @ 3V, 32 kHz
 - < 1 μ A typical standby current

PIC16C6X Microcontroller Core Features:

- High performance RISC CPU
- Only 35 single word instructions to learn
- All single cycle instructions except for program branches which are two-cycle
- Operating speed: DC - 20 MHz clock input
DC - 200 ns instruction cycle
- Interrupt capability
- Eight level deep hardware stack
- Direct, indirect, and relative addressing modes
- Power-on Reset (POR)
- Power-up Timer (PWRT) and Oscillator Start-up Timer (OST)
- Watchdog Timer (WDT) with its own on-chip RC oscillator for reliable operation
- Programmable code-protection
- Power saving SLEEP mode
- Selectable oscillator options

PIC16C6X Peripheral Features:

- Timer0: 8-bit timer/counter with 8-bit prescaler
- Timer1: 16-bit timer/counter with prescaler, can be incremented during sleep via external crystal/clock
- Timer2: 8-bit timer/counter with 8-bit period register, prescaler and postscale
- Capture/Compare/PWM (CCP) module(s)
- Capture is 16-bit, max resolution is 12.5 ns, Compare is 16-bit, max resolution is 200 ns, PWM max resolution is 10-bit.
- Synchronous Serial Port (SSP) with SPI and I²C™
- Universal Synchronous Asynchronous Receiver Transmitter (USART/SCI)
- Parallel Slave Port (PSP) 8-bits wide, with external \overline{RD} , \overline{WR} and \overline{CS} controls
- Brown-out detection circuitry for Brown-out Reset (BOR)

PIC16C6X Features	61	62	62A	R62	63	R63	64	64A	R64	65	65A	R65	66	67
Program Memory (EPROM) x 14	1K	2K	2K	—	4K	—	2K	2K	—	4K	4K	—	8K	8K
(ROM) x 14	—	—	—	2K	—	4K	—	—	2K	—	—	4K	—	—
Data Memory (Bytes) x 8	36	128	128	128	192	192	128	128	128	192	192	192	368	368
I/O Pins	13	22	22	22	22	22	33	33	33	33	33	33	22	33
Parallel Slave Port	—	—	—	—	—	—	Yes	Yes	Yes	Yes	Yes	Yes	—	Yes
Capture/Compare/PWM Module(s)	—	1	1	1	2	2	1	1	1	2	2	2	2	2
Timer Modules	1	3	3	3	3	3	3	3	3	3	3	3	3	3
Serial Communication	—	SPI/ I ² C	SPI/ I ² C	SPI/ I ² C	SPI/I ² C, USART	SPI/I ² C, USART	SPI/ I ² C	SPI/ I ² C	SPI/ I ² C	SPI/I ² C, USART	SPI/I ² C, USART	SPI/I ² C, USART	SPI/I ² C, USART	SPI/I ² C, USART
In-Circuit Serial Programming	Yes	Yes	Yes	Yes	Yes	Yes	Yes	Yes	Yes	Yes	Yes	Yes	Yes	Yes
Brown-out Reset	—	—	Yes	Yes	Yes	Yes	—	Yes	Yes	—	Yes	Yes	Yes	Yes
Interrupt Sources	3	7	7	7	10	10	8	8	8	11	11	11	10	11
Sink/Source Current (mA)	25/20	25/25	25/25	25/25	25/25	25/25	25/25	25/25	25/25	25/25	25/25	25/25	25/25	25/25

PIC16C6X

Pin Diagrams

PDIP, SOIC, Windowed CERDIP



PIC16C61

SDIP, SOIC, SSOP, Windowed CERDIP (300 mil)



PIC16C62

SDIP, SOIC, SSOP, Windowed CERDIP (300 mil)



**PIC16C62A
PIC16CR62**

SDIP, SOIC, Windowed CERDIP (300 mil)



**PIC16C63
PIC16CR63
PIC16C66**

PDIP, Windowed CERDIP



PIC16C64

**PIC16C64A
PIC16CR64**

**PIC16C65
PIC16C65A
PIC16CR65
PIC16C67**

PIC16C6X

Table Of Contents

1.0	General Description	5
2.0	PIC16C6X Device Varieties	7
3.0	Architectural Overview	9
4.0	Memory Organization.....	19
5.0	I/O Ports.....	51
6.0	Overview of Timer Modules	63
7.0	Timer0 Module	65
8.0	Timer1 Module	71
9.0	Timer2 Module	75
10.0	Capture/Compare/PWM (CCP) Module(s).....	77
11.0	Synchronous Serial Port (SSP) Module	83
12.0	Universal Synchronous Asynchronous Receiver Transmitter (USART) Module.....	105
13.0	Special Features of the CPU	123
14.0	Instruction Set Summary.....	143
15.0	Development Support	159
16.0	Electrical Characteristics for PIC16C61	163
17.0	DC and AC Characteristics Graphs and Tables for PIC16C61	173
18.0	Electrical Characteristics for PIC16C62/64	183
19.0	Electrical Characteristics for PIC16C62A/R62/64A/R64	199
20.0	Electrical Characteristics for PIC16C65	215
21.0	Electrical Characteristics for PIC16C63/65A	231
22.0	Electrical Characteristics for PIC16CR63/R65	247
23.0	Electrical Characteristics for PIC16C66/67	263
24.0	DC and AC Characteristics Graphs and Tables for: PIC16C62, PIC16C62A, PIC16CR62, PIC16C63, PIC16C64, PIC16C64A, PIC16CR64, PIC16C65A, PIC16C66, PIC16C67	281
25.0	Packaging Information	291
Appendix A:	Modifications	307
Appendix B:	Compatibility	307
Appendix C:	What's New	308
Appendix D:	What's Changed	308
Appendix E:	PIC16/17 Microcontrollers	309
	Pin Compatibility	315
	Index	317
	List of Equation and Examples.....	326
	List of Figures.....	326
	List of Tables.....	330
	Reader Response	334
	PIC16C6X Product Identification System.....	335

For register and module descriptions in this data sheet, device legends show which devices apply to those sections. For example, the legend below shows that some features of only the PIC16C62A, PIC16CR62, PIC16C63, PIC16C64A, PIC16CR64, and PIC16C65A are described in this section.

Applicable Devices													
61	62	62A	R62	63	R63	64	64A	R64	65	65A	R65	66	67

To Our Valued Customers

We constantly strive to improve the quality of all our products and documentation. We have spent an exceptional amount of time to ensure that these documents are correct. However, we realize that we may have missed a few things. If you find any information that is missing or appears in error, please use the reader response form in the back of this data sheet to inform us. We appreciate your assistance in making this a better document.

1.0 GENERAL DESCRIPTION

The PIC16CXX is a family of low-cost, high-performance, CMOS, fully-static, 8-bit microcontrollers.

All PIC16/17 microcontrollers employ an advanced RISC architecture. The PIC16CXX microcontroller family has enhanced core features, eight-level deep stack, and multiple internal and external interrupt sources. The separate instruction and data buses of the Harvard architecture allow a 14-bit wide instruction word with separate 8-bit wide data. The two stage instruction pipeline allows all instructions to execute in a single cycle, except for program branches (which require two cycles). A total of 35 instructions (reduced instruction set) are available. Additionally, a large register set gives some of the architectural innovations used to achieve a very high performance.

PIC16CXX microcontrollers typically achieve a 2:1 code compression and a 4:1 speed improvement over other 8-bit microcontrollers in their class.

The **PIC16C61** device has 36 bytes of RAM and 13 I/O pins. In addition a timer/counter is available.

The **PIC16C62/62A/R62** devices have 128 bytes of RAM and 22 I/O pins. In addition, several peripheral features are available, including: three timer/counters, one Capture/Compare/PWM module and one serial port. The Synchronous Serial Port can be configured as either a 3-wire Serial Peripheral Interface (SPI™) or the two-wire Inter-Integrated Circuit (I²C) bus.

The **PIC16C63/R63** devices have 192 bytes of RAM, while the **PIC16C66** has 368 bytes. All three devices have 22 I/O pins. In addition, several peripheral features are available, including: three timer/counters, two Capture/Compare/PWM modules and two serial ports. The Synchronous Serial Port can be configured as either a 3-wire Serial Peripheral Interface (SPI) or the two-wire Inter-Integrated Circuit (I²C) bus. The Universal Synchronous Asynchronous Receiver Transmitter (USART) is also known as a Serial Communications Interface or SCI.

The **PIC16C64/64A/R64** devices have 128 bytes of RAM and 33 I/O pins. In addition, several peripheral features are available, including: three timer/counters, one Capture/Compare/PWM module and one serial port. The Synchronous Serial Port can be configured as either a 3-wire Serial Peripheral Interface (SPI) or the two-wire Inter-Integrated Circuit (I²C) bus. An 8-bit Parallel Slave Port is also provided.

The **PIC16C65/65A/R65** devices have 192 bytes of RAM, while the **PIC16C67** has 368 bytes. All four devices have 33 I/O pins. In addition, several peripheral features are available, including: three timer/counters, two Capture/Compare/PWM modules and two serial ports. The Synchronous Serial Port can be configured as either a 3-wire Serial Peripheral Interface (SPI) or the two-wire Inter-Integrated Circuit (I²C) bus. The Universal Synchronous Asynchronous Receiver Transmitter

(USART) is also known as a Serial Communications Interface or SCI. An 8-bit Parallel Slave Port is also provided.

The PIC16C6X device family has special features to reduce external components, thus reducing cost, enhancing system reliability and reducing power consumption. There are four oscillator options, of which the single pin RC oscillator provides a low-cost solution, the LP oscillator minimizes power consumption, XT is a standard crystal, and the HS is for High Speed crystals. The SLEEP (power-down) mode offers a power saving mode. The user can wake the chip from SLEEP through several external and internal interrupts, and resets.

A highly reliable Watchdog Timer with its own on-chip RC oscillator provides protection against software lock-up.

A UV erasable CERDIP packaged version is ideal for code development, while the cost-effective One-Time-Programmable (OTP) version is suitable for production in any volume.

The PIC16C6X family fits perfectly in applications ranging from high-speed automotive and appliance control to low-power remote sensors, keyboards and telecom processors. The EPROM technology makes customization of application programs (transmitter codes, motor speeds, receiver frequencies, etc.) extremely fast and convenient. The small footprint packages make this microcontroller series perfect for all applications with space limitations. Low-cost, low-power, high performance, ease-of-use, and I/O flexibility make the PIC16C6X very versatile even in areas where no microcontroller use has been considered before (e.g. timer functions, serial communication, capture and compare, PWM functions, and co-processor applications).

1.1 Family and Upward Compatibility

Those users familiar with the PIC16C5X family of microcontrollers will realize that this is an enhanced version of the PIC16C5X architecture. Please refer to Appendix A for a detailed list of enhancements. Code written for PIC16C5X can be easily ported to PIC16CXX family of devices (Appendix B).

1.2 Development Support

PIC16C6X devices are supported by the complete line of Microchip Development tools.

Please refer to Section 15.0 for more details about Microchip's development tools.

PIC16C6X

TABLE 1-1: PIC16C6X FAMILY OF DEVICES

		PIC16C61	PIC16C62A	PIC16CR62	PIC16C63	PIC16CR63
Clock	Maximum Frequency of Operation (MHz)	20	20	20	20	20
Memory	EPROM Program Memory (x14 words)	1K	2K	—	4K	—
	ROM Program Memory (x14 words)	—	—	2K	—	4K
	Data Memory (bytes)	36	128	128	192	192
Peripherals	Timer Module(s)	TMR0	TMR0, TMR1, TMR2	TMR0, TMR1, TMR2	TMR0, TMR1, TMR2	TMR0, TMR1, TMR2
	Capture/Compare/PWM Module(s)	—	1	1	2	2
	Serial Port(s) (SPI/I ² C, USART)	—	SPI/I ² C	SPI/I ² C	SPI/I ² C, USART	SPI/I ² C, USART
	Parallel Slave Port	—	—	—	—	—
Features	Interrupt Sources	3	7	7	10	10
	I/O Pins	13	22	22	22	22
	Voltage Range (Volts)	3.0-6.0	2.5-6.0	2.5-6.0	2.5-6.0	2.5-6.0
	In-Circuit Serial Programming	Yes	Yes	Yes	Yes	Yes
	Brown-out Reset	—	Yes	Yes	Yes	Yes
	Packages	18-pin DIP, SO	28-pin SDIP, SOIC, SSOP	28-pin SDIP, SOIC, SSOP	28-pin SDIP, SOIC	28-pin SDIP, SOIC

		PIC16C64A	PIC16CR64	PIC16C65A	PIC16CR65	PIC16C66	PIC16C67
Clock	Maximum Frequency of Operation (MHz)	20	20	20	20	20	20
Memory	EPROM Program Memory (x14 words)	2K	—	4K	—	8K	8K
	ROM Program Memory (x14 words)	—	2K	—	4K	—	—
	Data Memory (bytes)	128	128	192	192	368	368
Peripherals	Timer Module(s)	TMR0, TMR1, TMR2	TMR0, TMR1, TMR2	TMR0, TMR1, TMR2	TMR0, TMR1, TMR2	TMR0, TMR1, TMR2	TMR0, TMR1, TMR2
	Capture/Compare/PWM Module(s)	1	1	2	2	2	2
	Serial Port(s) (SPI/I ² C, USART)	SPI/I ² C	SPI/I ² C	SPI/I ² C, USART	SPI/I ² C, USART	SPI/I ² C, USART	SPI/I ² C, USART
	Parallel Slave Port	Yes	Yes	Yes	Yes	—	Yes
Features	Interrupt Sources	8	8	11	11	10	11
	I/O Pins	33	33	33	33	22	33
	Voltage Range (Volts)	2.5-6.0	2.5-6.0	2.5-6.0	2.5-6.0	2.5-6.0	2.5-6.0
	In-Circuit Serial Programming	Yes	Yes	Yes	Yes	Yes	Yes
	Brown-out Reset	Yes	Yes	Yes	Yes	Yes	Yes
	Packages	40-pin DIP; 44-pin PLCC, MQFP, TQFP	40-pin DIP; 44-pin PLCC, MQFP, TQFP	40-pin DIP; 44-pin PLCC, MQFP, TQFP	40-pin DIP; 44-pin PLCC, MQFP, TQFP	28-pin SDIP, SOIC	40-pin DIP; 44-pin PLCC, MQFP, TQFP

All PIC16/17 Family devices have Power-on Reset, selectable Watchdog Timer, selectable code protect and high I/O current capability. All PIC16C6X Family devices use serial programming with clock pin RB6 and data pin RB7.

2.0 PIC16C6X DEVICE VARIETIES

A variety of frequency ranges and packaging options are available. Depending on application and production requirements, the proper device option can be selected using the information in the PIC16C6X Product Identification System section at the end of this data sheet. When placing orders, please use that page of the data sheet to specify the correct part number.

For the PIC16C6X family of devices, there are four device "types" as indicated in the device number:

1. **C**, as in PIC16C64. These devices have EPROM type memory and operate over the standard voltage range.
2. **LC**, as in PIC16LC64. These devices have EPROM type memory and operate over an extended voltage range.
3. **CR**, as in PIC16CR64. These devices have ROM program memory and operate over the standard voltage range.
4. **LCR**, as in PIC16LCR64. These devices have ROM program memory and operate over an extended voltage range.

2.1 UV Erasable Devices

The UV erasable version, offered in CERDIP package is optimal for prototype development and pilot programs. This version can be erased and reprogrammed to any of the oscillator modes.

Microchip's PICSTART® Plus and PRO MATE® II programmers both support programming of the PIC16C6X.

2.2 One-Time-Programmable (OTP) Devices

The availability of OTP devices is especially useful for customers who need the flexibility for frequent code updates and small volume applications.

The OTP devices, packaged in plastic packages, permit the user to program them once. In addition to the program memory, the configuration bits must also be programmed.

2.3 Quick-Turnaround-Production (QTP) Devices

Microchip offers a QTP Programming Service for factory production orders. This service is made available for users who choose not to program a medium to high quantity of units and whose code patterns have stabilized. The devices are identical to the OTP devices but with all EPROM locations and configuration options already programmed by the factory. Certain code and prototype verification procedures apply before production shipments are available. Please contact your local Microchip Technology sales office for more details.

2.4 Serialized Quick-Turnaround Production (SQTPSM) Devices

Microchip offers a unique programming service where a few user-defined locations in each device are programmed with different serial numbers. The serial numbers may be random, pseudo-random, or sequential.

Serial programming allows each device to have a unique number which can serve as an entry-code, password, or ID number.

ROM devices do not allow serialization information in the program memory space. The user may have this information programmed in the data memory space.

For information on submitting ROM code, please contact your regional sales office.

2.5 Read Only Memory (ROM) Devices

Microchip offers masked ROM versions of several of the highest volume parts, thus giving customers a low cost option for high volume, mature products.

For information on submitting ROM code, please contact your regional sales office.

PIC16C6X

NOTES:

3.0 ARCHITECTURAL OVERVIEW

The high performance of the PIC16CXX family can be attributed to a number of architectural features commonly found in RISC microprocessors. To begin with, the PIC16CXX uses a Harvard architecture, in which, program and data are accessed from separate memories using separate buses. This improves bandwidth over traditional von Neumann architecture where program and data may be fetched from the same memory using the same bus. Separating program and data buses further allows instructions to be sized differently than 8-bit wide data words. Instruction opcodes are 14-bits wide making it possible to have all single word instructions. A 14-bit wide program memory access bus fetches a 14-bit instruction in a single cycle. A two-stage pipeline overlaps fetch and execution of instructions (Example 3-1). Consequently, all instructions execute in a single cycle (200 ns @ 20 MHz) except for program branches.

The PIC16C61 addresses 1K x 14 of program memory. The PIC16C62/62A/R62/64/64A/R64 address 2K x 14 of program memory, and the PIC16C63/R63/65/65A/R65 devices address 4K x 14 of program memory. The PIC16C66/67 address 8K x 14 program memory. All program memory is internal.

The PIC16CXX can directly or indirectly address its register files or data memory. All special function registers including the program counter are mapped in the data memory. The PIC16CXX has an orthogonal (symmetrical) instruction set that makes it possible to carry out any operation on any register using any addressing mode. This symmetrical nature and lack of "special optimal situations" makes programming with the PIC16CXX simple yet efficient, thus significantly reducing the learning curve.

The PIC16CXX device contains an 8-bit ALU and working register (W). The ALU is a general purpose arithmetic unit. It performs arithmetic and Boolean functions between data in the working register and any register file.

The ALU is 8-bits wide and capable of addition, subtraction, shift, and logical operations. Unless otherwise mentioned, arithmetic operations are two's complement in nature. In two-operand instructions, typically one operand is the working register (W register), the other operand is a file register or an immediate constant. In single operand instructions, the operand is either the W register or a file register.

The W register is an 8-bit working register used for ALU operations. It is not an addressable register.

Depending upon the instruction executed, the ALU may affect the values of the Carry (C), Digit Carry (DC), and Zero (Z) bits in the STATUS register. Bits C and DC operate as a borrow and digit borrow out bit, respectively, in subtraction. See the `SUBLW` and `SUBWF` instructions for examples.

PIC16C6X

FIGURE 3-1: PIC16C61 BLOCK DIAGRAM



FIGURE 3-2: PIC16C62/62A/R62/64/64A/R64 BLOCK DIAGRAM



- Note 1: Higher order bits are from the STATUS register.
 Note 2: PORTD, PORTE and the Parallel Slave Port are not available on the PIC16C62/62A/R62.
 Note 3: Brown-out Reset is not available on the PIC16C62/64.
 Note 4: Pin functions T1OSI and T1OSO are swapped on the PIC16C62/64.

PIC16C6X

FIGURE 3-3: PIC16C63/R63/65/65A/R65 BLOCK DIAGRAM



Note 1: Higher order bits are from the STATUS register.

Note 2: PORTD, PORTE and the Parallel Slave Port are not available on the PIC16C63/R63.

Note 3: Brown-out Reset is not available on the PIC16C65.

FIGURE 3-4: PIC16C66/67 BLOCK DIAGRAM



- Note 1: Higher order bits are from the STATUS register.
 Note 2: PORTD, PORTE and the Parallel Slave Port are not available on the PIC16C66.

PIC16C6X

TABLE 3-1: PIC16C61 PINOUT DESCRIPTION

Pin Name	DIP Pin#	SOIC Pin#	Pin Type	Buffer Type	Description
OSC1/CLKIN	16	16	I	ST/CMOS ⁽¹⁾	Oscillator crystal input/external clock source input.
OSC2/CLKOUT	15	15	O	—	Oscillator crystal output. Connects to crystal or resonator in crystal oscillator mode. In RC mode, the pin outputs CLKOUT which has 1/4 the frequency of OSC1, and denotes the instruction cycle rate.
MCLR/VPP	4	4	I/P	ST	Master clear reset input or programming voltage input. This pin is an active low reset to the device.
RA0	17	17	I/O	TTL	PORTA is a bi-directional I/O port. RA4 can also be the clock input to the Timer0 timer/counter. Output is open drain type.
RA1	18	18	I/O	TTL	
RA2	1	1	I/O	TTL	
RA3	2	2	I/O	TTL	
RA4/T0CKI	3	3	I/O	ST	
RB0/INT	6	6	I/O	TTL/ST ⁽²⁾	PORTB is a bi-directional I/O port. PORTB can be software programmed for internal weak pull-up on all inputs. RB0 can also be the external interrupt pin. Interrupt on change pin. Interrupt on change pin. Interrupt on change pin. Serial programming clock. Interrupt on change pin. Serial programming data.
RB1	7	7	I/O	TTL	
RB2	8	8	I/O	TTL	
RB3	9	9	I/O	TTL	
RB4	10	10	I/O	TTL	
RB5	11	11	I/O	TTL	
RB6	12	12	I/O	TTL/ST ⁽³⁾	
RB7	13	13	I/O	TTL/ST ⁽³⁾	
VSS	5	5	P	—	Ground reference for logic and I/O pins.
VDD	14	14	P	—	Positive supply for logic and I/O pins.

Legend: I = input O = output I/O = input/output P = power
 — = Not used TTL = TTL input ST = Schmitt Trigger input

- Note 1: This buffer is a Schmitt Trigger input when configured in RC oscillator mode and a CMOS input otherwise.
 Note 2: This buffer is a Schmitt Trigger input when configured as the external interrupt.
 Note 3: This buffer is a Schmitt Trigger input when used in serial programming mode.

TABLE 3-2: PIC16C62/62A/R62/63/R63/66 PINOUT DESCRIPTION

Pin Name	Pin#	Pin Type	Buffer Type	Description
OSC1/CLKIN	9	I	ST/CMOS ⁽³⁾	Oscillator crystal input/external clock source input.
OSC2/CLKOUT	10	O	—	Oscillator crystal output. Connects to crystal or resonator in crystal oscillator mode. In RC mode, the pin outputs CLKOUT which has 1/4 the frequency of OSC1, and denotes the instruction cycle rate.
MCLR/VPP	1	I/P	ST	Master clear reset input or programming voltage input. This pin is an active low reset to the device.
RA0	2	I/O	TTL	PORTA is a bi-directional I/O port. RA4 can also be the clock input to the Timer0 timer/counter. Output is open drain type. RA5 can also be the slave select for the synchronous serial port.
RA1	3	I/O	TTL	
RA2	4	I/O	TTL	
RA3	5	I/O	TTL	
RA4/T0CKI	6	I/O	ST	
RA5/SS	7	I/O	TTL	
RB0/INT	21	I/O	TTL/ST ⁽⁴⁾	PORTB is a bi-directional I/O port. PORTB can be software programmed for internal weak pull-up on all inputs. RB0 can also be the external interrupt pin. Interrupt on change pin. Interrupt on change pin. Interrupt on change pin. Serial programming clock. Interrupt on change pin. Serial programming data.
RB1	22	I/O	TTL	
RB2	23	I/O	TTL	
RB3	24	I/O	TTL	
RB4	25	I/O	TTL	
RB5	26	I/O	TTL	
RB6	27	I/O	TTL/ST ⁽⁵⁾	
RB7	28	I/O	TTL/ST ⁽⁵⁾	
RC0/T1OSO ⁽¹⁾ /T1CKI	11	I/O	ST	PORTC is a bi-directional I/O port. RC0 can also be the Timer1 oscillator output ⁽¹⁾ or Timer1 clock input. RC1 can also be the Timer1 oscillator input ⁽¹⁾ or Capture2 input/Compare2 output/PWM2 output ⁽²⁾ . RC2 can also be the Capture1 input/Compare1 output/PWM1 output. RC3 can also be the synchronous serial clock input/output for both SPI and I ² C modes. RC4 can also be the SPI Data In (SPI mode) or data I/O (I ² C mode). RC5 can also be the SPI Data Out (SPI mode). RC6 can also be the USART Asynchronous Transmit ⁽²⁾ or Synchronous Clock ⁽²⁾ . RC7 can also be the USART Asynchronous Receive ⁽²⁾ or Synchronous Data ⁽²⁾ .
RC1/T1OSI ⁽¹⁾ /CCP2 ⁽²⁾	12	I/O	ST	
RC2/CCP1	13	I/O	ST	
RC3/SCK/SCL	14	I/O	ST	
RC4/SDI/SDA	15	I/O	ST	
RC5/SDO	16	I/O	ST	
RC6/TX/CK ⁽²⁾	17	I/O	ST	
RC7/RX/DT ⁽²⁾	18	I/O	ST	
Vss	8,19	P	—	Ground reference for logic and I/O pins.
VDD	20	P	—	Positive supply for logic and I/O pins.

Legend: I = input O = output I/O = input/output P = power
 — = Not used TTL = TTL input ST = Schmitt Trigger input

- Note 1: Pin functions T1OSO and T1OSI are reversed on the PIC16C62.
 2: The USART and CCP2 are not available on the PIC16C62/62A/R62.
 3: This buffer is a Schmitt Trigger input when configured in RC oscillator mode and a CMOS input otherwise.
 4: This buffer is a Schmitt Trigger input when configured as the external interrupt.
 5: This buffer is a Schmitt Trigger input when used in serial programming mode.

PIC16C6X

TABLE 3-3: PIC16C64/64A/R64/65/65A/R65/67 PINOUT DESCRIPTION

Pin Name	DIP Pin#	PLCC Pin#	TQFP MQFP Pin#	Pin Type	Buffer Type	Description
OSC1/CLKIN	13	14	30	I	ST/CMOS ⁽³⁾	Oscillator crystal input/external clock source input.
OSC2/CLKOUT	14	15	31	O	—	Oscillator crystal output. Connects to crystal or resonator in crystal oscillator mode. In RC mode, the pin outputs CLKOUT which has 1/4 the frequency of OSC1, and denotes the instruction cycle rate.
MCLR/VPP	1	2	18	I/P	ST	Master clear reset input or programming voltage input. This pin is an active low reset to the device.
RA0	2	3	19	I/O	TTL	PORTA is a bi-directional I/O port. RA4 can also be the clock input to the Timer0 timer/counter. Output is open drain type. RA5 can also be the slave select for the synchronous serial port.
RA1	3	4	20	I/O	TTL	
RA2	4	5	21	I/O	TTL	
RA3	5	6	22	I/O	TTL	
RA4/T0CKI	6	7	23	I/O	ST	
RA5/SS	7	8	24	I/O	TTL	
RB0/INT	33	36	8	I/O	TTL/ST ⁽⁴⁾	PORTB is a bi-directional I/O port. PORTB can be software programmed for internal weak pull-up on all inputs. RB0 can also be the external interrupt pin. Interrupt on change pin. Interrupt on change pin. Interrupt on change pin. Serial programming clock. Interrupt on change pin. Serial programming data.
RB1	34	37	9	I/O	TTL	
RB2	35	38	10	I/O	TTL	
RB3	36	39	11	I/O	TTL	
RB4	37	41	14	I/O	TTL	
RB5	38	42	15	I/O	TTL	
RB6	39	43	16	I/O	TTL/ST ⁽⁵⁾	
RB7	40	44	17	I/O	TTL/ST ⁽⁵⁾	
RC0/T1OSO ⁽¹⁾ /T1CKI	15	16	32	I/O	ST	PORTC is a bi-directional I/O port. RC0 can also be the Timer1 oscillator output ⁽¹⁾ or Timer1 clock input. RC1 can also be the Timer1 oscillator input ⁽¹⁾ or Capture2 input/Compare2 output/PWM2 output ⁽²⁾ . RC2 can also be the Capture1 input/Compare1 output/PWM1 output. RC3 can also be the synchronous serial clock input/output for both SPI and I ² C modes. RC4 can also be the SPI Data In (SPI mode) or data I/O (I ² C mode). RC5 can also be the SPI Data Out (SPI mode). RC6 can also be the USART Asynchronous Transmit ⁽²⁾ or Synchronous Clock ⁽²⁾ . RC7 can also be the USART Asynchronous Receive ⁽²⁾ or Synchronous Data ⁽²⁾ .
RC1/T1OSI ⁽¹⁾ /CCP2 ⁽²⁾	16	18	35	I/O	ST	
RC2/CCP1	17	19	36	I/O	ST	
RC3/SCK/SCL	18	20	37	I/O	ST	
RC4/SDI/SDA	23	25	42	I/O	ST	
RC5/SDO	24	26	43	I/O	ST	
RC6/TX/CK ⁽²⁾	25	27	44	I/O	ST	
RC7/RX/DT ⁽²⁾	26	29	1	I/O	ST	

Legend: I = input O = output I/O = input/output P = power
 — = Not used TTL = TTL input ST = Schmitt Trigger input

- Note 1: Pin functions T1OSO and T1OSI are reversed on the PIC16C64.
 2: CCP2 and the USART are not available on the PIC16C64/64A/R64.
 3: This buffer is a Schmitt Trigger input when configured in RC oscillator mode and a CMOS input otherwise.
 4: This buffer is a Schmitt Trigger input when configured as the external interrupt.
 5: This buffer is a Schmitt Trigger input when used in serial programming mode.
 6: This buffer is a Schmitt Trigger input when configured as general purpose I/O and a TTL input when used in the Parallel Slave Port mode (for interfacing to a microprocessor bus).

TABLE 3-3: PIC16C64/64A/R64/65/65A/R65/67 PINOUT DESCRIPTION (Cont'd)

Pin Name	DIP Pin#	PLCC Pin#	TQFP MQFP Pin#	Pin Type	Buffer Type	Description
RD0/PSP0	19	21	38	I/O	ST/TTL ⁽⁶⁾	PORTD can be a bi-directional I/O port or parallel slave port for interfacing to a microprocessor bus.
RD1/PSP1	20	22	39	I/O	ST/TTL ⁽⁶⁾	
RD2/PSP2	21	23	40	I/O	ST/TTL ⁽⁶⁾	
RD3/PSP3	22	24	41	I/O	ST/TTL ⁽⁶⁾	
RD4/PSP4	27	30	2	I/O	ST/TTL ⁽⁶⁾	
RD5/PSP5	28	31	3	I/O	ST/TTL ⁽⁶⁾	
RD6/PSP6	29	32	4	I/O	ST/TTL ⁽⁶⁾	
RD7/PSP7	30	33	5	I/O	ST/TTL ⁽⁶⁾	
RE0/ \overline{RD}	8	9	25	I/O	ST/TTL ⁽⁶⁾	PORTE is a bi-directional I/O port. RE0 can also be read control for the parallel slave port. RE1 can also be write control for the parallel slave port. RE2 can also be select control for the parallel slave port.
RE1/ \overline{WR}	9	10	26	I/O	ST/TTL ⁽⁶⁾	
RE2/ \overline{CS}	10	11	27	I/O	ST/TTL ⁽⁶⁾	
Vss	12,31	13,34	6,29	P	—	Ground reference for logic and I/O pins.
VDD	11,32	12,35	7,28	P	—	Positive supply for logic and I/O pins.
NC	—	1,17,28,40	12,13,33,34	—	—	These pins are not internally connected. These pins should be left unconnected.

Legend: I = input O = output I/O = input/output P = power
 — = Not used TTL = TTL input ST = Schmitt Trigger input

- Note 1: Pin functions T1OSO and T1OSI are reversed on the PIC16C64.
 2: CCP2 and the USART are not available on the PIC16C64/64A/R64.
 3: This buffer is a Schmitt Trigger input when configured in RC oscillator mode and a CMOS input otherwise.
 4: This buffer is a Schmitt Trigger input when configured as the external interrupt.
 5: This buffer is a Schmitt Trigger input when used in serial programming mode.
 6: This buffer is a Schmitt Trigger input when configured as general purpose I/O and a TTL input when used in the Parallel Slave Port mode (for interfacing to a microprocessor bus).

PIC16C6X

3.1 Clocking Scheme/Instruction Cycle

The clock input (from OSC1) is internally divided by four to generate four non-overlapping quadrature clocks namely Q1, Q2, Q3, and Q4. Internally, the program counter (PC) is incremented every Q1, the instruction is fetched from the program memory and latched into the instruction register in Q4. The instruction is decoded and executed during the following Q1 through Q4. The clock and instruction execution flow is shown in Figure 3-5.

3.2 Instruction Flow/Pipelining

An "Instruction Cycle" consists of four Q cycles (Q1, Q2, Q3, and Q4). The instruction fetch and execute are pipelined such that fetch takes one instruction cycle while decode and execute takes another instruction cycle. However, due to the pipelining, each instruction effectively executes in one cycle. If an instruction causes the program counter to change (e.g. GOTO) then two cycles are required to complete the instruction (Example 3-1).

A fetch cycle begins with the program counter (PC) incrementing in Q1.

In the execution cycle, the fetched instruction is latched into the "Instruction Register (IR)" in cycle Q1. This instruction is then decoded and executed during the Q2, Q3, and Q4 cycles. Data memory is read during Q2 (operand read) and written during Q4 (destination write).

FIGURE 3-5: CLOCK/INSTRUCTION CYCLE



EXAMPLE 3-1: INSTRUCTION PIPELINE FLOW



4.0 MEMORY ORGANIZATION

Applicable Devices													
61	62	62A	R62	63	R63	64	64A	R64	65	65A	R65	66	67

4.1 Program Memory Organization

The PIC16C6X family has a 13-bit program counter capable of addressing an 8K x 14 program memory space. The amount of program memory available to each device is listed below:

Device	Program Memory	Address Range
PIC16C61	1K x 14	0000h-03FFh
PIC16C62	2K x 14	0000h-07FFh
PIC16C62A	2K x 14	0000h-07FFh
PIC16CR62	2K x 14	0000h-07FFh
PIC16C63	4K x 14	0000h-0FFFh
PIC16CR63	4K x 14	0000h-0FFFh
PIC16C64	2K x 14	0000h-07FFh
PIC16C64A	2K x 14	0000h-07FFh
PIC16CR64	2K x 14	0000h-07FFh
PIC16C65	4K x 14	0000h-0FFFh
PIC16C65A	4K x 14	0000h-0FFFh
PIC16CR65	4K x 14	0000h-0FFFh
PIC16C66	8K x 14	0000h-1FFFh
PIC16C67	8K x 14	0000h-1FFFh

For those devices with less than 8K program memory, accessing a location above the physically implemented address will cause a wraparound.

The reset vector is at 0000h and the interrupt vector is at 0004h.

FIGURE 4-1: PIC16C61 PROGRAM MEMORY MAP AND STACK



FIGURE 4-2: PIC16C62/62A/R62/64/64A/R64 PROGRAM MEMORY MAP AND STACK



FIGURE 4-3: PIC16C63/R63/65/65A/R65 PROGRAM MEMORY MAP AND STACK



PIC16C6X

FIGURE 4-4: PIC16C66/67 PROGRAM MEMORY MAP AND STACK



4.2 Data Memory Organization

Applicable Devices													
61	62	62A	R62	63	R63	64	64A	R64	65	65A	R65	66	67

The data memory is partitioned into multiple banks which contain the General Purpose Registers and the Special Function Registers. Bits RP1 and RP0 are the bank select bits.

RP1:RP0 (STATUS<6:5>)
 = 00 → Bank0
 = 01 → Bank1
 = 10 → Bank2
 = 11 → Bank3

Each bank extends up to 7Fh (128 bytes). The lower locations of each bank are reserved for the Special Function Registers. Above the Special Function Registers are General Purpose Registers, implemented as static RAM. All implemented banks contain special function registers. Some "high use" special function registers from one bank may be mirrored in another bank for code reduction and quicker access.

4.2.1 GENERAL PURPOSE REGISTERS

These registers are accessed either directly or indirectly through the File Select Register (FSR) (Section 4.5).

For the PIC16C61, general purpose register locations 8Ch-AFh of Bank 1 are not physically implemented. These locations are mapped into 0Ch-2Fh of Bank 0.

FIGURE 4-5: PIC16C61 REGISTER FILE MAP

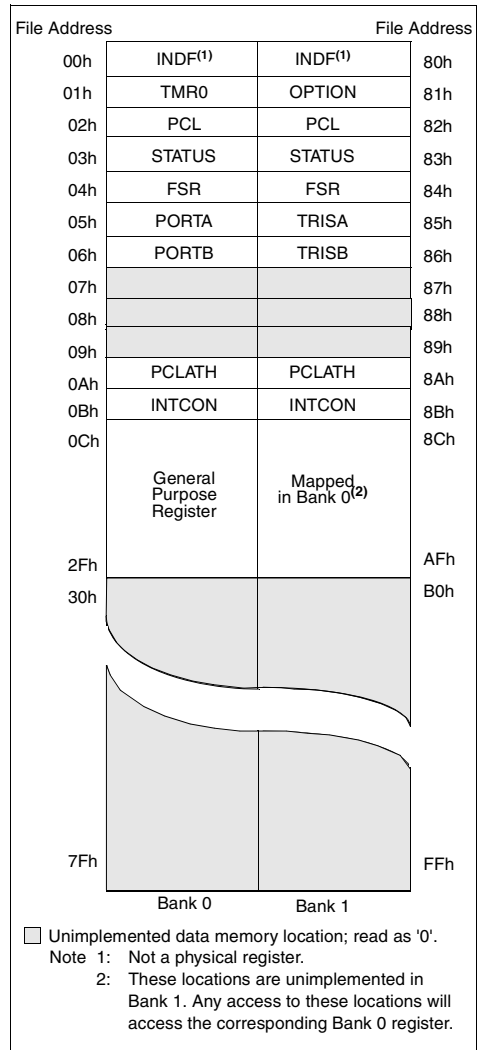

FIGURE 4-6: PIC16C62/62A/R62/64/64A/R64 REGISTER FILE MAP

File Address		File Address	
00h	INDF ⁽¹⁾	INDF ⁽¹⁾	80h
01h	TMR0	OPTION	81h
02h	PCL	PCL	82h
03h	STATUS	STATUS	83h
04h	FSR	FSR	84h
05h	PORTA	TRISA	85h
06h	PORTB	TRISB	86h
07h	PORTC	TRISC	87h
08h	PORTD ⁽²⁾	TRISD ⁽²⁾	88h
09h	PORTE ⁽²⁾	TRISE ⁽²⁾	89h
0Ah	PCLATH	PCLATH	8Ah
0Bh	INTCON	INTCON	8Bh
0Ch	PIR1	PIE1	8Ch
0Dh			8Dh
0Eh	TMR1L	PCON	8Eh
0Fh	TMR1H		8Fh
10h	T1CON		90h
11h	TMR2		91h
12h	T2CON	PR2	92h
13h	SSPBUF	SSPADD	93h
14h	SSPCON	SSPSTAT	94h
15h	CCPR1L		95h
16h	CCPR1H		96h
17h	CCP1CON		97h
18h			98h
19h			99h
1Ah			9Ah
1Bh			9Bh
1Ch			9Ch
1Dh			9Dh
1Eh			9Eh
1Fh			9Fh
20h	General Purpose Register	General Purpose Register	A0h
			BFh
			C0h
			FFh
7Fh			FFh

Bank 0 Bank 1

Unimplemented data memory location; read as '0'.

Note 1: Not a physical register.
 2: PORTD and PORTE are not available on the PIC16C62/62A/R62.

FIGURE 4-7: PIC16C63/R63/65/65A/R65 REGISTER FILE MAP

File Address		File Address	
00h	INDF ⁽¹⁾	INDF ⁽¹⁾	80h
01h	TMR0	OPTION	81h
02h	PCL	PCL	82h
03h	STATUS	STATUS	83h
04h	FSR	FSR	84h
05h	PORTA	TRISA	85h
06h	PORTB	TRISB	86h
07h	PORTC	TRISC	87h
08h	PORTD ⁽²⁾	TRISD ⁽²⁾	88h
09h	PORTE ⁽²⁾	TRISE ⁽²⁾	89h
0Ah	PCLATH	PCLATH	8Ah
0Bh	INTCON	INTCON	8Bh
0Ch	PIR1	PIE1	8Ch
0Dh	PIR2	PIE2	8Dh
0Eh	TMR1L	PCON	8Eh
0Fh	TMR1H		8Fh
10h	T1CON		90h
11h	TMR2		91h
12h	T2CON	PR2	92h
13h	SSPBUF	SSPADD	93h
14h	SSPCON	SSPSTAT	94h
15h	CCPR1L		95h
16h	CCPR1H		96h
17h	CCP1CON		97h
18h	RCSTA	TXSTA	98h
19h	TXREG	SPBRG	99h
1Ah	RCREG		9Ah
1Bh	CCPR2L		9Bh
1Ch	CCPR2H		9Ch
1Dh	CCP2CON		9Dh
1Eh			9Eh
1Fh			9Fh
20h	General Purpose Register	General Purpose Register	A0h
			FFh
7Fh			FFh

Bank 0 Bank 1

Unimplemented data memory location; read as '0'.

Note 1: Not a physical register.
 2: PORTD and PORTE are not available on the PIC16C63/R63.

PIC16C6X

FIGURE 4-8: PIC16C66/67 DATA MEMORY MAP

						File Address	
Indirect addr. ^(*)	00h	Indirect addr. ^(*)	80h	Indirect addr. ^(*)	100h	Indirect addr. ^(*)	180h
TMR0	01h	OPTION	81h	TMR0	101h	OPTION	181h
PCL	02h	PCL	82h	PCL	102h	PCL	182h
STATUS	03h	STATUS	83h	STATUS	103h	STATUS	183h
FSR	04h	FSR	84h	FSR	104h	FSR	184h
PORTA	05h	TRISA	85h		105h		185h
PORTB	06h	TRISB	86h	PORTB	106h	TRISB	186h
PORTC	07h	TRISC	87h		107h		187h
PORTD ⁽¹⁾	08h	TRISD ⁽¹⁾	88h		108h		188h
PORTE ⁽¹⁾	09h	TRISE ⁽¹⁾	89h		109h		189h
PCLATH	0Ah	PCLATH	8Ah	PCLATH	10Ah	PCLATH	18Ah
INTCON	0Bh	INTCON	8Bh	INTCON	10Bh	INTCON	18Bh
PIR1	0Ch	PIE1	8Ch		10Ch		18Ch
PIR2	0Dh	PIE2	8Dh		10Dh		18Dh
TMR1L	0Eh	PCON	8Eh		10Eh		18Eh
TMR1H	0Fh		8Fh		10Fh		18Fh
T1CON	10h		90h		110h		190h
TMR2	11h		91h		111h		191h
T2CON	12h	PR2	92h		112h		192h
SSPBUF	13h	SSPADD	93h		113h		193h
SSPCON	14h	SSPSTAT	94h		114h		194h
CCPR1L	15h		95h		115h		195h
CCPR1H	16h		96h		116h		196h
CCP1CON	17h		97h	General Purpose Register 16 Bytes	117h	General Purpose Register 16 Bytes	197h
RCSTA	18h	TXSTA	98h		118h		198h
TXREG	19h	SPBRG	99h		119h		199h
RCREG	1Ah		9Ah		11Ah		19Ah
CCPR2L	1Bh		9Bh		11Bh		19Bh
CCPR2H	1Ch		9Ch		11Ch		19Ch
CCP2CON	1Dh		9Dh		11Dh		19Dh
	1Eh		9Eh		11Eh		19Eh
	1Fh		9Fh		11Fh		19Fh
	20h		A0h		120h		1A0h
General Purpose Register 96 Bytes		General Purpose Register 80 Bytes		General Purpose Register 80 Bytes		General Purpose Register 80 Bytes	
	7Fh	accesses 70h-7Fh in Bank 0	EFh F0h FFh	accesses 70h-7Fh in Bank 0	16Fh 170h 17Fh	accesses 70h-7Fh in Bank 0	1EFh 1F0h 1FFh
Bank 0		Bank 1		Bank 2		Bank 3	

Unimplemented data memory locations, read as '0'.
 * Not a physical register.

These registers are not implemented on the PIC16C66.

Note: The upper 16 bytes of data memory in banks 1, 2, and 3 are mapped in Bank 0. This may require relocation of data memory usage in the user application code if upgrading to the PIC16C66/67.

4.2.2 SPECIAL FUNCTION REGISTERS:

The Special Function Registers are registers used by the CPU and peripheral modules for controlling the desired operation of the device. These registers are implemented as static RAM.

The special function registers can be classified into two sets (core and peripheral). The registers associated with the “core” functions are described in this section and those related to the operation of the peripheral features are described in the section of that peripheral feature.

TABLE 4-1: SPECIAL FUNCTION REGISTERS FOR THE PIC16C61

Address	Name	Bit 7	Bit 6	Bit 5	Bit 4	Bit 3	Bit 2	Bit 1	Bit 0	Value on: POR	Value on all other resets ⁽³⁾	
Bank 0												
00h ⁽¹⁾	INDF	Addressing this location uses contents of FSR to address data memory (not a physical register)								0000 0000	0000 0000	
01h	TMR0	Timer0 module's register								xxxx xxxx	uuuu uuuu	
02h ⁽¹⁾	PCL	Program Counter's (PC) Least Significant Byte								0000 0000	0000 0000	
03h ⁽¹⁾	STATUS	IRP ⁽⁴⁾	RP1 ⁽⁴⁾	RP0	\overline{TO}	\overline{PD}	Z	DC	C	0001 1xxxx	000q quuu	
04h ⁽¹⁾	FSR	Indirect data memory address pointer								xxxx xxxx	uuuu uuuu	
05h	PORTA	—	—	—	PORTA Data Latch when written: PORTA pins when read						--x xxxx	--u uuuu
06h	PORTB	PORTB Data Latch when written: PORTB pins when read								xxxx xxxx	uuuu uuuu	
07h	—	Unimplemented								—	—	
08h	—	Unimplemented								—	—	
09h	—	Unimplemented								—	—	
0Ah ^(1,2)	PCLATH	—	—	—	Write Buffer for the upper 5 bits of the Program Counter						--0 0000	--0 0000
0Bh ⁽¹⁾	INTCON	GIE	—	TOIE	INTE	RBIE	TOIF	INTF	RBIF	0-00 000x	0-00 000u	
Bank 1												
80h ⁽¹⁾	INDF	Addressing this location uses contents of FSR to address data memory (not a physical register)								0000 0000	0000 0000	
81h	OPTION	\overline{RBPU}	INTEDG	TOCS	T0SE	PSA	PS2	PS1	PS0	1111 1111	1111 1111	
82h ⁽¹⁾	PCL	Program Counter's (PC) Least Significant Byte								0000 0000	0000 0000	
83h ⁽¹⁾	STATUS	IRP ⁽⁴⁾	RP1 ⁽⁴⁾	RP0	\overline{TO}	\overline{PD}	Z	DC	C	0001 1xxxx	000q quuu	
84h ⁽¹⁾	FSR	Indirect data memory address pointer								xxxx xxxx	uuuu uuuu	
85h	TRISA	—	—	—	PORTA Data Direction Register						--1 1111	--1 1111
86h	TRISB	PORTB Data Direction Control Register								1111 1111	1111 1111	
87h	—	Unimplemented								—	—	
88h	—	Unimplemented								—	—	
89h	—	Unimplemented								—	—	
8Ah ^(1,2)	PCLATH	—	—	—	Write Buffer for the upper 5 bits of the Program Counter						--0 0000	--0 0000
8Bh ⁽¹⁾	INTCON	GIE	—	TOIE	INTE	RBIE	TOIF	INTF	RBIF	0-00 000x	0-00 000u	

Legend: x = unknown, u = unchanged, q = value depends on condition, - = unimplemented locations read as '0'.

Shaded locations are unimplemented and read as '0'

Note 1: These registers can be addressed from either bank.

Note 2: The upper byte of the Program Counter (PC) is not directly accessible. PCLATH is a holding register for the PC whose contents are transferred to the upper byte of the program counter. (PC<12:8>)

Note 3: Other (non power-up) resets include external reset through MCLR and the Watchdog Timer Reset.

Note 4: The IRP and RP1 bits are reserved on the PIC16C61, always maintain these bits clear.

PIC16C6X

TABLE 4-2: SPECIAL FUNCTION REGISTERS FOR THE PIC16C62/62A/R62

Address	Name	Bit 7	Bit 6	Bit 5	Bit 4	Bit 3	Bit 2	Bit 1	Bit 0	Value on: POR, BOR	Value on all other resets ⁽³⁾
Bank 0											
00h ⁽¹⁾	INDF	Addressing this location uses contents of FSR to address data memory (not a physical register)								0000 0000	0000 0000
01h	TMR0	Timer0 module's register								xxxx xxxx	uuuu uuuu
02h ⁽¹⁾	PCL	Program Counter's (PC) Least Significant Byte								0000 0000	0000 0000
03h ⁽¹⁾	STATUS	IRP ⁽⁵⁾	RP1 ⁽⁵⁾	RP0	\overline{TO}	\overline{PD}	Z	DC	C	0001 1xxx	000q quuu
04h ⁽¹⁾	FSR	Indirect data memory address pointer								xxxx xxxx	uuuu uuuu
05h	PORTA	—	—	PORTA Data Latch when written: PORTA pins when read						--xx xxxx	--uu uuuu
06h	PORTB	PORTB Data Latch when written: PORTB pins when read								xxxx xxxx	uuuu uuuu
07h	PORTC	PORTC Data Latch when written: PORTC pins when read								xxxx xxxx	uuuu uuuu
08h	—	Unimplemented								—	—
09h	—	Unimplemented								—	—
0Ah ^(1,2)	PCLATH	—	—	—	Write Buffer for the upper 5 bits of the Program Counter					---0 0000	---0 0000
0Bh ⁽¹⁾	INTCON	GIE	PEIE	T0IE	INTE	RBIE	T0IF	INTF	RBFIF	0000 000x	0000 000u
0Ch	PIR1	(6)	(6)	—	—	SSPIF	CCP1IF	TMR2IF	TMR1IF	00-- 0000	00-- 0000
0Dh	—	Unimplemented								—	—
0Eh	TMR1L	Holding register for the Least Significant Byte of the 16-bit TMR1 register								xxxx xxxx	uuuu uuuu
0Fh	TMR1H	Holding register for the Most Significant Byte of the 16-bit TMR1 register								xxxx xxxx	uuuu uuuu
10h	T1CON	—	—	T1CKPS1	T1CKPS0	T1OSCEN	T1TSYNC	TMR1CS	TMR1ON	--00 0000	--uu uuuu
11h	TMR2	Timer2 module's register								0000 0000	0000 0000
12h	T2CON	—	TOUTPS3	TOUTPS2	TOUTPS1	TOUTPS0	TMR2ON	T2CKPS1	T2CKPS0	-000 0000	-000 0000
13h	SSPBUF	Synchronous Serial Port Receive Buffer/Transmit Register								xxxx xxxx	uuuu uuuu
14h	SSPCON	WCOL	SSPOV	SSPEN	CKP	SSPM3	SSPM2	SSPM1	SSPM0	0000 0000	0000 0000
15h	CCPR1L	Capture/Compare/PWM1 (LSB)								xxxx xxxx	uuuu uuuu
16h	CCPR1H	Capture/Compare/PWM1 (MSB)								xxxx xxxx	uuuu uuuu
17h	CCP1CON	—	—	CCP1X	CCP1Y	CCP1M3	CCP1M2	CCP1M1	CCP1M0	--00 0000	--00 0000
18h-1Fh	—	Unimplemented								—	—

Legend: x = unknown, u = unchanged, q = value depends on condition, - = unimplemented location read as '0'.
Shaded locations are unimplemented, read as '0'.

- Note 1: These registers can be addressed from either bank.
 2: The upper byte of the Program Counter (PC) is not directly accessible. PCLATH is a holding register for the PC whose contents are transferred to the upper byte of the program counter. (PC<12:8>)
 3: Other (non power-up) resets include external reset through MCLR and the Watchdog Timer reset.
 4: The BOR bit is reserved on the PIC16C62, always maintain this bit set.
 5: The IRP and RP1 bits are reserved on the PIC16C62/62A/R62, always maintain these bits clear.
 6: PIE1<7:6> and PIR1<7:6> are reserved on the PIC16C62/62A/R62, always maintain these bits clear.

TABLE 4-2: SPECIAL FUNCTION REGISTERS FOR THE PIC16C62/62A/R62 (Cont'd)

Address	Name	Bit 7	Bit 6	Bit 5	Bit 4	Bit 3	Bit 2	Bit 1	Bit 0	Value on: POR, BOR	Value on all other resets ⁽³⁾
Bank 1											
80h ⁽¹⁾	INDF	Addressing this location uses contents of FSR to address data memory (not a physical register)								0000 0000	0000 0000
81h	OPTION	$\overline{\text{RBPU}}$	INTEDG	T0CS	T0SE	PSA	PS2	PS1	PS0	1111 1111	1111 1111
82h ⁽¹⁾	PCL	Program Counter's (PC) Least Significant Byte								0000 0000	0000 0000
83h ⁽¹⁾	STATUS	$\overline{\text{IRP}}^{(5)}$	$\overline{\text{RP1}}^{(5)}$	RP0	$\overline{\text{TO}}$	$\overline{\text{PD}}$	Z	DC	C	0001 1xxx	000q quuu
84h ⁽¹⁾	FSR	Indirect data memory address pointer								xxxx xxxx	uuuu uuuu
85h	TRISA	—	—	PORTA Data Direction Register						--11 1111	--11 1111
86h	TRISB	PORTB Data Direction Register								1111 1111	1111 1111
87h	TRISC	PORTC Data Direction Register								1111 1111	1111 1111
88h	—	Unimplemented								—	—
89h	—	Unimplemented								—	—
8Ah ^(1,2)	PCLATH	—	—	—	Write Buffer for the upper 5 bits of the Program Counter					---0 0000	---0 0000
8Bh ⁽¹⁾	INTCON	GIE	PEIE	T0IE	INTE	RBIE	T0IF	INTF	RBIF	0000 000x	0000 000u
8Ch	PIE1	(6)	(6)	—	—	SSPIE	CCP1IE	TMR2IE	TMR1IE	00-- 0000	00-- 0000
8Dh	—	Unimplemented								—	—
8Eh	PCON	—	—	—	—	—	—	$\overline{\text{POR}}$	$\overline{\text{BOR}}^{(4)}$	---- --qq	---- --uu
8Fh	—	Unimplemented								—	—
90h	—	Unimplemented								—	—
91h	—	Unimplemented								—	—
92h	PR2	Timer2 Period Register								1111 1111	1111 1111
93h	SSPADD	Synchronous Serial Port (I ² C mode) Address Register								0000 0000	0000 0000
94h	SSPSTAT	—	—	$\overline{\text{D/A}}$	P	S	$\overline{\text{R/W}}$	UA	BF	--00 0000	--00 0000
95h-9Fh	—	Unimplemented								—	—

Legend: x = unknown, u = unchanged, q = value depends on condition, - = unimplemented location read as '0'.
 Shaded locations are unimplemented, read as '0'.

- Note 1: These registers can be addressed from either bank.
- The upper byte of the Program Counter (PC) is not directly accessible. PCLATH is a holding register for the PC whose contents are transferred to the upper byte of the program counter. (PC<12:8>)
 - Other (non power-up) resets include external reset through MCLR and the Watchdog Timer reset.
 - The $\overline{\text{BOR}}$ bit is reserved on the PIC16C62, always maintain this bit set.
 - The IRP and RP1 bits are reserved on the PIC16C62/62A/R62, always maintain these bits clear.
 - The PIE1<7:6> and PIR1<7:6> are reserved on the PIC16C62/62A/R62, always maintain these bits clear.

TABLE 4-3: SPECIAL FUNCTION REGISTERS FOR THE PIC16C63/R63

Address	Name	Bit 7	Bit 6	Bit 5	Bit 4	Bit 3	Bit 2	Bit 1	Bit 0	Value on: POR, BOR	Value on all other resets ⁽³⁾
Bank 0											
00h ⁽¹⁾	INDF	Addressing this location uses contents of FSR to address data memory (not a physical register)								0000 0000	0000 0000
01h	TMR0	Timer0 module's register								xxxx xxxx	uuuu uuuu
02h ⁽¹⁾	PCL	Program Counter's (PC) Least Significant Byte								0000 0000	0000 0000
03h ⁽¹⁾	STATUS	IRP ⁽⁴⁾	RP1 ⁽⁴⁾	RP0	\overline{TO}	\overline{PD}	Z	DC	C	0001 1xxx	000q quuu
04h ⁽¹⁾	FSR	Indirect data memory address pointer								xxxx xxxx	uuuu uuuu
05h	PORTA	—	—	PORTA Data Latch when written: PORTA pins when read						--xx xxxx	--uu uuuu
06h	PORTB	PORTB Data Latch when written: PORTB pins when read								xxxx xxxx	uuuu uuuu
07h	PORTC	PORTC Data Latch when written: PORTC pins when read								xxxx xxxx	uuuu uuuu
08h	—	Unimplemented								—	—
09h	—	Unimplemented								—	—
0Ah ^(1,2)	PCLATH	—	—	—	Write Buffer for the upper 5 bits of the Program Counter					---0 0000	---0 0000
0Bh ⁽¹⁾	INTCON	GIE	PEIE	TOIE	INTE	RBIE	TOIF	INTF	RBIF	0000 000x	0000 000u
0Ch	PIR1	(5)	(5)	RCIF	TXIF	SSPIF	CCP1IF	TMR2IF	TMR1IF	0000 0000	0000 0000
0Dh	PIR2	—	—	—	—	—	—	—	CCP2IF	---- --0	---- --0
0Eh	TMR1L	Holding register for the Least Significant Byte of the 16-bit TMR1 register								xxxx xxxx	uuuu uuuu
0Fh	TMR1H	Holding register for the Most Significant Byte of the 16-bit TMR1 register								xxxx xxxx	uuuu uuuu
10h	T1CON	—	—	T1CKPS1	T1CKPS0	T1OSCEN	$\overline{T1SYN}$ C	TMR1CS	TMR1ON	--00 0000	--uu uuuu
11h	TMR2	Timer2 module's register								0000 0000	0000 0000
12h	T2CON	—	TOUTPS3	TOUTPS2	TOUTPS1	TOUTPS0	TMR2ON	T2CKPS1	T2CKPS0	-000 0000	-000 0000
13h	SSPBUF	Synchronous Serial Port Receive Buffer/Transmit Register								xxxx xxxx	uuuu uuuu
14h	SSPCON	WCOL	SSPOV	SSPEN	CKP	SSPM3	SSPM2	SSPM1	SSPM0	0000 0000	0000 0000
15h	CCPR1L	Capture/Compare/PWM1 (LSB)								xxxx xxxx	uuuu uuuu
16h	CCPR1H	Capture/Compare/PWM1 (MSB)								xxxx xxxx	uuuu uuuu
17h	CCP1CON	—	—	CCP1X	CCP1Y	CCP1M3	CCP1M2	CCP1M1	CCP1M0	--00 0000	--00 0000
18h	RCSTA	SPEN	RX9	SREN	CREN	—	FERR	OERR	RX9D	0000 -00x	0000 -00x
19h	TXREG	USART Transmit Data Register								0000 0000	0000 0000
1Ah	RCREG	USART Receive Data Register								0000 0000	0000 0000
1Bh	CCPR2L	Capture/Compare/PWM2 (LSB)								xxxx xxxx	uuuu uuuu
1Ch	CCPR2H	Capture/Compare/PWM2 (MSB)								xxxx xxxx	uuuu uuuu
1Dh	CCP2CON	—	—	CCP2X	CCP2Y	CCP2M3	CCP2M2	CCP2M1	CCP2M0	--00 0000	--00 0000
1Eh-1Fh	—	Unimplemented								—	—

Legend: x = unknown, u = unchanged, q = value depends on condition, - = unimplemented location read as '0'.
 Shaded locations are unimplemented, read as '0'.

Note 1: These registers can be addressed from either bank.

- The upper byte of the Program Counter (PC) is not directly accessible. PCLATH is a holding register for the PC whose contents are transferred to the upper byte of the program counter. (PC<12:8>)
- Other (non power-up) resets include external reset through \overline{MCLR} and the Watchdog Timer reset.
- The IRP and RP1 bits are reserved on the PIC16C63/R63, always maintain these bits clear.
- PIE1<7:6> and PIR1<7:6> are reserved on the PIC16C63/R63, always maintain these bits clear.

TABLE 4-3: SPECIAL FUNCTION REGISTERS FOR THE PIC16C63/R63 (Cont'd)

Address	Name	Bit 7	Bit 6	Bit 5	Bit 4	Bit 3	Bit 2	Bit 1	Bit 0	Value on: POR, BOR	Value on all other resets ⁽³⁾
Bank 1											
80h ⁽¹⁾	INDF	Addressing this location uses contents of FSR to address data memory (not a physical register)								0000 0000	0000 0000
81h	OPTION	RP0	INTEDG	T0CS	T0SE	PSA	PS2	PS1	PS0	1111 1111	1111 1111
82h ⁽¹⁾	PCL	Program Counter's (PC) Least Significant Byte								0000 0000	0000 0000
83h ⁽¹⁾	STATUS	IRP ⁽⁴⁾	RP1 ⁽⁴⁾	RP0	T0	PD	Z	DC	C	0001 1xxx	000q quuu
84h ⁽¹⁾	FSR	Indirect data memory address pointer								xxxx xxxx	uuuu uuuu
85h	TRISA	—	—	PORTA Data Direction Register						--11 1111	--11 1111
86h	TRISB	PORTB Data Direction Register								1111 1111	1111 1111
87h	TRISC	PORTC Data Direction Register								1111 1111	1111 1111
88h	—	Unimplemented								—	—
89h	—	Unimplemented								—	—
8Ah ^(1,2)	PCLATH	—	—	—	Write Buffer for the upper 5 bits of the Program Counter					---0 0000	---0 0000
8Bh ⁽¹⁾	INTCON	GIE	PEIE	T0IE	INTE	RBIE	T0IF	INTF	RBIF	0000 000x	0000 000u
8Ch	PIE1	(5)	(5)	RCIE	TXIE	SSPIE	CCP1IE	TMR2IE	TMR1IE	0000 0000	0000 0000
8Dh	PIE2	—	—	—	—	—	—	—	CCP2IE	---- --0	---- --0
8Eh	PCON	—	—	—	—	—	—	POR	BOR	---- --qq	---- --uu
8Fh	—	Unimplemented								—	—
90h	—	Unimplemented								—	—
91h	—	Unimplemented								—	—
92h	PR2	Timer2 Period Register								1111 1111	1111 1111
93h	SSPADD	Synchronous Serial Port (I ² C mode) Address Register								0000 0000	0000 0000
94h	SSPSTAT	—	—	D/A	P	S	R/W	UA	BF	--00 0000	--00 0000
95h	—	Unimplemented								—	—
96h	—	Unimplemented								—	—
97h	—	Unimplemented								—	—
98h ⁽²⁾	TXSTA	CSRC	TX9	TXEN	SYNC	—	BRGH	TRMT	TX9D	0000 -010	0000 -010
99h ⁽²⁾	SPBRG	Baud Rate Generator Register								0000 0000	0000 0000
9Ah	—	Unimplemented								—	—
9Bh	—	Unimplemented								—	—
9Ch	—	Unimplemented								—	—
9Dh	—	Unimplemented								—	—
9Eh	—	Unimplemented								—	—
9Fh	—	Unimplemented								—	—

Legend: x = unknown, u = unchanged, q = value depends on condition, - = unimplemented location read as '0'.
Shaded locations are unimplemented, read as '0'.

Note 1: These registers can be addressed from either bank.

2: The upper byte of the Program Counter (PC) is not directly accessible. PCLATH is a holding register for the PC whose contents are transferred to the upper byte of the program counter. (PC<12:8>)

3: Other (non power-up) resets include external reset through MCLR and the Watchdog Timer reset.

4: The IRP and RP1 bits are reserved on the PIC16C63/R63, always maintain these bits clear.

5: PIE1<7:6> and PIR1<7:6> are reserved on the PIC16C63/R63, always maintain these bits clear.

PIC16C6X

TABLE 4-4: SPECIAL FUNCTION REGISTERS FOR THE PIC16C64/64A/R64

Address	Name	Bit 7	Bit 6	Bit 5	Bit 4	Bit 3	Bit 2	Bit 1	Bit 0	Value on: POR, BOR	Value on all other resets ⁽³⁾
Bank 0											
00h ⁽¹⁾	INDF	Addressing this location uses contents of FSR to address data memory (not a physical register)								0000 0000	0000 0000
01h	TMR0	Timer0 module's register								xxxx xxxx	uuuu uuuu
02h ⁽¹⁾	PCL	Program Counter's (PC) Least Significant Byte								0000 0000	0000 0000
03h ⁽¹⁾	STATUS	IRP ⁽⁵⁾	RP1 ⁽⁵⁾	RP0	\overline{TO}	\overline{PD}	Z	DC	C	0001 1xxx	000q quuu
04h ⁽¹⁾	FSR	Indirect data memory address pointer								xxxx xxxx	uuuu uuuu
05h	PORTA	—	—	PORTA Data Latch when written: PORTA pins when read						--xx xxxx	--uu uuuu
06h	PORTB	PORTB Data Latch when written: PORTB pins when read								xxxx xxxx	uuuu uuuu
07h	PORTC	PORTC Data Latch when written: PORTC pins when read								xxxx xxxx	uuuu uuuu
08h	PORTD	PORTD Data Latch when written: PORTD pins when read								xxxx xxxx	uuuu uuuu
09h	PORTE	—	—	—	—	—	RE2	RE1	RE0	---- -xxx	---- -uuu
0Ah ^(1,2)	PCLATH	—	—	—	Write Buffer for the upper 5 bits of the Program Counter					---0 0000	---0 0000
0Bh ⁽¹⁾	INTCON	GIE	PEIE	T0IE	INTE	RBIE	T0IF	INTF	RBFIF	0000 000x	0000 000u
0Ch	PIR1	PSPIF	(6)	—	—	SSPIF	CCP1IF	TMR2IF	TMR1IF	00-- 0000	00-- 0000
0Dh	—	Unimplemented								—	—
0Eh	TMR1L	Holding register for the Least Significant Byte of the 16-bit TMR1 register								xxxx xxxx	uuuu uuuu
0Fh	TMR1H	Holding register for the Most Significant Byte of the 16-bit TMR1 register								xxxx xxxx	uuuu uuuu
10h	T1CON	—	—	T1CKPS1	T1CKPS0	T1OSCEN	T1SYNC	TMR1CS	TMR1ON	--00 0000	--uu uuuu
11h	TMR2	Timer2 module's register								0000 0000	0000 0000
12h	T2CON	—	TOUTPS3	TOUTPS2	TOUTPS1	TOUTPS0	TMR2ON	T2CKPS1	T2CKPS0	-000 0000	-000 0000
13h	SSPBUF	Synchronous Serial Port Receive Buffer/Transmit Register								xxxx xxxx	uuuu uuuu
14h	SSPCON	WCOL	SSPOV	SSPEN	CKP	SSPM3	SSPM2	SSPM1	SSPM0	0000 0000	0000 0000
15h	CCPR1L	Capture/Compare/PWM1 (LSB)								xxxx xxxx	uuuu uuuu
16h	CCPR1H	Capture/Compare/PWM1 (MSB)								xxxx xxxx	uuuu uuuu
17h	CCP1CON	—	—	CCP1X	CCP1Y	CCP1M3	CCP1M2	CCP1M1	CCP1M0	--00 0000	--00 0000
18h-1Fh	—	Unimplemented								—	—

Legend: x = unknown, u = unchanged, q = value depends on condition, - = unimplemented location read as '0'.
Shaded locations are unimplemented, read as '0'.

Note 1: These registers can be addressed from either bank.

2: The upper byte of the Program Counter (PC) is not directly accessible. PCLATH is a holding register for the PC whose contents are transferred to the upper byte of the program counter. (PC<12:8>)

3: Other (non power-up) resets include external reset through MCLR and the Watchdog Timer reset.

4: The BOR bit is reserved on the PIC16C64, always maintain this bit set.

5: The IRP and RP1 bits are reserved on the PIC16C64/64A/R64, always maintain these bits clear.

6: PIE1<6> and PIR1<6> are reserved on the PIC16C64/64A/R64, always maintain these bits clear.

TABLE 4-4: SPECIAL FUNCTION REGISTERS FOR THE PIC16C64/64A/R64 (Cont'd)

Address	Name	Bit 7	Bit 6	Bit 5	Bit 4	Bit 3	Bit 2	Bit 1	Bit 0	Value on: POR, BOR	Value on all other resets ⁽³⁾	
Bank 1												
80h ⁽¹⁾	INDF	Addressing this location uses contents of FSR to address data memory (not a physical register)								0000 0000	0000 0000	
81h	OPTION	RBPU	INTEDG	T0CS	T0SE	PSA	PS2	PS1	PS0	1111 1111	1111 1111	
82h ⁽¹⁾	PCL	Program Counter's (PC) Least Significant Byte								0000 0000	0000 0000	
83h ⁽¹⁾	STATUS	IRP ⁽⁵⁾	RP1 ⁽⁵⁾	RP0	T0	PD	Z	DC	C	0001 1xxx	000q quuu	
84h ⁽¹⁾	FSR	Indirect data memory address pointer								xxxx xxxx	uuuu uuuu	
85h	TRISA	—	—	PORTA Data Direction Register						--11 1111	--11 1111	
86h	TRISB	PORTB Data Direction Register								1111 1111	1111 1111	
87h	TRISC	PORTC Data Direction Register								1111 1111	1111 1111	
88h	TRISD	PORTD Data Direction Register								1111 1111	1111 1111	
89h	TRISE	IBF	OBF	IBOV	PSPMODE	—	PORTE Data Direction Bits			0000 -111	0000 -111	
8Ah ^(1,2)	PCLATH	—	—	—	Write Buffer for the upper 5 bits of the Program Counter						--0 0000	--0 0000
8Bh ⁽¹⁾	INTCON	GIE	PEIE	TOIE	INTE	RBIE	TOIF	INTF	RBIF	0000 000x	0000 000u	
8Ch	PIE1	PSPIE	(6)	—	—	SSPIE	CCP1IE	TMR2IE	TMR1IE	00-- 0000	00-- 0000	
8Dh	—	Unimplemented								—	—	
8Eh	PCON	—	—	—	—	—	—	POR	BOR ⁽⁴⁾	---- -gqg	---- -uuu	
8Fh	—	Unimplemented								—	—	
90h	—	Unimplemented								—	—	
91h	—	Unimplemented								—	—	
92h	PR2	Timer2 Period Register								1111 1111	1111 1111	
93h	SSPADD	Synchronous Serial Port (I ² C mode) Address Register								0000 0000	0000 0000	
94h	SSPSTAT	—	—	D/A	P	S	R/W	UA	BF	--00 0000	--00 0000	
95h-9Fh	—	Unimplemented								—	—	

Legend: x = unknown, u = unchanged, q = value depends on condition, - = unimplemented location read as '0'.
Shaded locations are unimplemented, read as '0'.

- Note 1: These registers can be addressed from either bank.
 2: The upper byte of the Program Counter (PC) is not directly accessible. PCLATH is a holding register for the PC whose contents are transferred to the upper byte of the program counter. (PC<12:8>)
 3: Other (non power-up) resets include external reset through MCLR and the Watchdog Timer reset.
 4: The BOR bit is reserved on the PIC16C64, always maintain this bit set.
 5: The IRP and RP1 bits are reserved on the PIC16C64/64A/R64, always maintain these bits clear.
 6: PIE1<6> and PIR1<6> are reserved on the PIC16C64/64A/R64, always maintain these bits clear.

PIC16C6X

TABLE 4-5: SPECIAL FUNCTION REGISTERS FOR THE PIC16C65/65A/R65

Address	Name	Bit 7	Bit 6	Bit 5	Bit 4	Bit 3	Bit 2	Bit 1	Bit 0	Value on: POR, BOR	Value on all other resets ⁽³⁾		
Bank 0													
00h ⁽¹⁾	INDF	Addressing this location uses contents of FSR to address data memory (not a physical register)								0000 0000	0000 0000		
01h	TMR0	Timer0 module's register								xxxx xxxx	uuuu uuuu		
02h ⁽¹⁾	PCL	Program Counter's (PC) Least Significant Byte								0000 0000	0000 0000		
03h ⁽¹⁾	STATUS	IRP ⁽⁵⁾	RP1 ⁽⁵⁾	RP0	\overline{TO}	\overline{PD}	Z	DC	C	0001 1xxx	000q guuu		
04h ⁽¹⁾	FSR	Indirect data memory address pointer								xxxx xxxx	uuuu uuuu		
05h	PORTA	—	—	PORTA Data Latch when written: PORTA pins when read								--xx xxxx	--uu uuuu
06h	PORTB	PORTB Data Latch when written: PORTB pins when read										xxxx xxxx	uuuu uuuu
07h	PORTC	PORTC Data Latch when written: PORTC pins when read										xxxx xxxx	uuuu uuuu
08h	PORTD	PORTD Data Latch when written: PORTD pins when read										xxxx xxxx	uuuu uuuu
09h	PORTE	—	—	—	—	—	RE2	RE1	RE0	---- -xxx	---- -uuu		
0Ah ^(1,2)	PCLATH	—	—	—	Write Buffer for the upper 5 bits of the Program Counter					---- 0000	---- 0000		
0Bh ⁽¹⁾	INTCON	GIE	PEIE	T0IE	INTE	RBIE	T0IF	INTF	RBFIF	0000 000x	0000 000u		
0Ch	PIR1	PSPIF	(6)	RCIF	TXIF	SSPIF	CCP1IF	TMR2IF	TMR1IF	0000 0000	0000 0000		
0Dh	PIR2	—	—	—	—	—	—	—	CCP2IF	---- --0	---- --0		
0Eh	TMR1L	Holding register for the Least Significant Byte of the 16-bit TMR1 register								xxxx xxxx	uuuu uuuu		
0Fh	TMR1H	Holding register for the Most Significant Byte of the 16-bit TMR1 register								xxxx xxxx	uuuu uuuu		
10h	T1CON	—	—	T1CKPS1	T1CKPS0	T1OSCEN	$\overline{T1SYNC}$	TMR1CS	TMR1ON	--00 0000	--uu uuuu		
11h	TMR2	Timer2 module's register								0000 0000	0000 0000		
12h	T2CON	—	TOUTPS3	TOUTPS2	TOUTPS1	TOUTPS0	TMR2ON	T2CKPS1	T2CKPS0	-000 0000	-000 0000		
13h	SSPBUF	Synchronous Serial Port Receive Buffer/Transmit Register								xxxx xxxx	uuuu uuuu		
14h	SSPCON	WCOL	SSPOV	SSPEN	CKP	SSPM3	SSPM2	SSPM1	SSPM0	0000 0000	0000 0000		
15h	CCPR1L	Capture/Compare/PWM1 (LSB)								xxxx xxxx	uuuu uuuu		
16h	CCPR1H	Capture/Compare/PWM1 (MSB)								xxxx xxxx	uuuu uuuu		
17h	CCP1CON	—	—	CCP1X	CCP1Y	CCP1M3	CCP1M2	CCP1M1	CCP1M0	--00 0000	--00 0000		
18h	RCSTA	SPEN	RX9	SREN	CREN	—	FERR	OERR	RX9D	0000 -00x	0000 -00x		
19h	TXREG	USART Transmit Data Register								0000 0000	0000 0000		
1Ah	RCREG	USART Receive Data Register								0000 0000	0000 0000		
1Bh	CCPR2L	Capture/Compare/PWM2 (LSB)								xxxx xxxx	uuuu uuuu		
1Ch	CCPR2H	Capture/Compare/PWM2 (MSB)								xxxx xxxx	uuuu uuuu		
1Dh	CCP2CON	—	—	CCP2X	CCP2Y	CCP2M3	CCP2M2	CCP2M1	CCP2M0	--00 0000	--00 0000		
1Eh-1Fh	—	Unimplemented								—	—		

Legend: x = unknown, u = unchanged, q = value depends on condition, - = unimplemented location read as '0'.
Shaded locations are unimplemented, read as '0'.

Note 1: These registers can be addressed from either bank.

- 2: The upper byte of the Program Counter (PC) is not directly accessible. PCLATH is a holding register for the PC whose contents are transferred to the upper byte of the program counter. (PC<12:8>)
- 3: Other (non power-up) resets include external reset through MCLR and the Watchdog Timer reset.
- 4: The BOR bit is reserved on the PIC16C65, always maintain this bit set.
- 5: The IRP and RP1 bits are reserved on the PIC16C65/65A/R65, always maintain these bits clear.
- 6: PIE1<6> and PIR1<6> are reserved on the PIC16C65/65A/R65, always maintain these bits clear.

TABLE 4-5: SPECIAL FUNCTION REGISTERS FOR THE PIC16C65/65A/R65 (Cont'd)

Address	Name	Bit 7	Bit 6	Bit 5	Bit 4	Bit 3	Bit 2	Bit 1	Bit 0	Value on: POR, BOR	Value on all other resets ⁽³⁾
Bank 1											
80h ⁽¹⁾	INDF	Addressing this location uses contents of FSR to address data memory (not a physical register)								0000 0000	0000 0000
81h	OPTION	RBP _U	INTE _{EDG}	T0CS	T0SE	PSA	PS2	PS1	PS0	1111 1111	1111 1111
82h ⁽¹⁾	PCL	Program Counter's (PC) Least Significant Byte								0000 0000	0000 0000
83h ⁽¹⁾	STATUS	IRP ⁽⁵⁾	RP1 ⁽⁵⁾	RP0	T _O	P _D	Z	DC	C	0001 1xxx	000q quuu
84h ⁽¹⁾	FSR	Indirect data memory address pointer								xxxx xxxx	uuuu uuuu
85h	TRISA	—	—	PORTA Data Direction Register						--11 1111	--11 1111
86h	TRISB	PORTB Data Direction Register								1111 1111	1111 1111
87h	TRISC	PORTC Data Direction Register								1111 1111	1111 1111
88h	TRISD	PORTD Data Direction Register								1111 1111	1111 1111
89h	TRISE	IBF	OBF	IBOV	PSPMODE	—	PORTE Data Direction Bits			0000 -111	0000 -111
8Ah ^(1,2)	PCLATH	—	—	—	Write Buffer for the upper 5 bits of the Program Counter					--0 0000	--0 0000
8Bh ⁽¹⁾	INTCON	GIE	PEIE	TOIE	INTE	RBIE	TOIF	INTF	RBIF	0000 000x	0000 000u
8Ch	PIE1	PSPIE	(6)	RCIE	TXIE	SSPIE	CCP1IE	TMR2IE	TMR1IE	0000 0000	0000 0000
8Dh	PIE2	—	—	—	—	—	—	—	CCP2IE	---- --0	---- --0
8Eh	PCON	—	—	—	—	—	—	POR	BOR ⁽⁴⁾	---- -gg	---- -uu
8Fh	—	Unimplemented								—	—
90h	—	Unimplemented								—	—
91h	—	Unimplemented								—	—
92h	PR2	Timer2 Period Register								1111 1111	1111 1111
93h	SSPADD	Synchronous Serial Port (I ² C mode) Address Register								0000 0000	0000 0000
94h	SSPSTAT	—	—	D _A	P	S	R _W	UA	BF	--00 0000	--00 0000
95h	—	Unimplemented								—	—
96h	—	Unimplemented								—	—
97h	—	Unimplemented								—	—
98h	TXSTA	CSRC	TX9	TXEN	SYNC	—	BRGH	TRMT	TX9D	0000 -010	0000 -010
99h	SPBRG	Baud Rate Generator Register								0000 0000	0000 0000
9Ah	—	Unimplemented								—	—
9Bh	—	Unimplemented								—	—
9Ch	—	Unimplemented								—	—
9Dh	—	Unimplemented								—	—
9Eh	—	Unimplemented								—	—
9Fh	—	Unimplemented								—	—

Legend: x = unknown, u = unchanged, q = value depends on condition, - = unimplemented location read as '0'.
Shaded locations are unimplemented, read as '0'.

- Note 1: These registers can be addressed from either bank.
 2: The upper byte of the Program Counter (PC) is not directly accessible. PCLATH is a holding register for the PC whose contents are transferred to the upper byte of the program counter. (PC<12:8>)
 3: Other (non power-up) resets include external reset through MCLR and the Watchdog Timer reset.
 4: The BOR bit is reserved on the PIC16C65, always maintain this bit set.
 5: The IRP and RP1 bits are reserved on the PIC16C65/65A/R65, always maintain these bits clear.
 6: PIE1<6> and PIR1<6> are reserved on the PIC16C65/65A/R65, always maintain these bits clear.

PIC16C6X

TABLE 4-6: SPECIAL FUNCTION REGISTERS FOR THE PIC16C66/67

Address	Name	Bit 7	Bit 6	Bit 5	Bit 4	Bit 3	Bit 2	Bit 1	Bit 0	Value on: POR, BOR	Value on all other resets ⁽³⁾
Bank 0											
00h ⁽¹⁾	INDF	Addressing this location uses contents of FSR to address data memory (not a physical register)								0000 0000	0000 0000
01h	TMR0	Timer0 module's register								xxxx xxxx	uuuu uuuu
02h ⁽¹⁾	PCL	Program Counter's (PC) Least Significant Byte								0000 0000	0000 0000
03h ⁽¹⁾	STATUS	IRP	RP1	RP0	\overline{TO}	\overline{PD}	Z	DC	C	0001 1xxx	000q quuu
04h ⁽¹⁾	FSR	Indirect data memory address pointer								xxxx xxxx	uuuu uuuu
05h	PORTA	—	—	PORTA Data Latch when written: PORTA pins when read						--xx xxxx	--uu uuuu
06h	PORTB	PORTB Data Latch when written: PORTB pins when read								xxxx xxxx	uuuu uuuu
07h	PORTC	PORTC Data Latch when written: PORTC pins when read								xxxx xxxx	uuuu uuuu
08h ⁽⁵⁾	PORTD	PORTD Data Latch when written: PORTD pins when read								xxxx xxxx	uuuu uuuu
09h ⁽⁵⁾	PORTE	—	—	—	—	—	RE2	RE1	RE0	---- -xxx	---- -uuu
0Ah ^(1,2)	PCLATH	—	—	—	Write Buffer for the upper 5 bits of the Program Counter					--0 0000	--0 0000
0Bh ⁽¹⁾	INTCON	GIE	PEIE	T0IE	INTE	RBIE	T0IF	INTF	RBFIF	0000 000x	0000 000u
0Ch	PIR1	PSPIF ⁽⁶⁾	(4)	RCIF	TXIF	SSPIF	CCP1IF	TMR2IF	TMR1IF	0000 0000	0000 0000
0Dh	PIR2	—	—	—	—	—	—	—	CCP2IF	---- -000	---- -000
0Eh	TMR1L	Holding register for the Least Significant Byte of the 16-bit TMR1 register								xxxx xxxx	uuuu uuuu
0Fh	TMR1H	Holding register for the Most Significant Byte of the 16-bit TMR1 register								xxxx xxxx	uuuu uuuu
10h	T1CON	—	—	T1CKPS1	T1CKPS0	T1OSCEN	T1SYNC	TMR1CS	TMR1ON	--00 0000	--uu uuuu
11h	TMR2	Timer2 module's register								0000 0000	0000 0000
12h	T2CON	—	TOUTPS3	TOUTPS2	TOUTPS1	TOUTPS0	TMR2ON	T2CKPS1	T2CKPS0	-000 0000	-000 0000
13h	SSPBUF	Synchronous Serial Port Receive Buffer/Transmit Register								xxxx xxxx	uuuu uuuu
14h	SSPCON	WCOL	SSPOV	SSPEN	CKP	SSPM3	SSPM2	SSPM1	SSPM0	0000 0000	0000 0000
15h	CCPR1L	Capture/Compare/PWM1 (LSB)								xxxx xxxx	uuuu uuuu
16h	CCPR1H	Capture/Compare/PWM1 (MSB)								xxxx xxxx	uuuu uuuu
17h	CCP1CON	—	—	CCP1X	CCP1Y	CCP1M3	CCP1M2	CCP1M1	CCP1M0	--00 0000	--00 0000
18h	RCSTA	SPEN	RX9	SREN	CREN	—	FERR	OERR	RX9D	0000 -00x	0000 -00x
19h	TXREG	USART Transmit Data Register								0000 0000	0000 0000
1Ah	RCREG	USART Receive Data Register								0000 0000	0000 0000
1Bh	CCPR2L	Capture/Compare/PWM2 (LSB)								xxxx xxxx	uuuu uuuu
1Ch	CCPR2H	Capture/Compare/PWM2 (MSB)								xxxx xxxx	uuuu uuuu
1Dh	CCP2CON	—	—	CCP2X	CCP2Y	CCP2M3	CCP2M2	CCP2M1	CCP2M0	--00 0000	--00 0000
1Eh-1Fh	—	Unimplemented								—	—

Legend: x = unknown, u = unchanged, q = value depends on condition, - = unimplemented location read as '0'.
Shaded locations are unimplemented, read as '0'.

Note 1: These registers can be addressed from any bank.

2: The upper byte of the Program Counter (PC) is not directly accessible. PCLATH is a holding register for the PC whose contents are transferred to the upper byte of the program counter. (PC<12:8>)

3: Other (non power-up) resets include external reset through MCLR and the Watchdog Timer reset.

4: PIE1<6> and PIR1<6> are reserved on the PIC16C66/67, always maintain these bits clear.

5: PORTD, PORTE, TRISD, and TRISE are not implemented on the PIC16C66, read as '0'.

6: PSPIF (PIR1<7>) and PSPIE (PIE1<7>) are reserved on the PIC16C66, maintain these bits clear.

TABLE 4-6: SPECIAL FUNCTION REGISTERS FOR THE PIC16C66/67 (Cont'd)

Address	Name	Bit 7	Bit 6	Bit 5	Bit 4	Bit 3	Bit 2	Bit 1	Bit 0	Value on: POR, BOR	Value on all other resets ⁽³⁾	
Bank 1												
80h ⁽¹⁾	INDF	Addressing this location uses contents of FSR to address data memory (not a physical register)								0000 0000	0000 0000	
81h	OPTION	RBPU	INTEDG	T0CS	T0SE	PSA	PS2	PS1	PS0	1111 1111	1111 1111	
82h ⁽¹⁾	PCL	Program Counter's (PC) Least Significant Byte								0000 0000	0000 0000	
83h ⁽¹⁾	STATUS	IRP	RP1	RP0	T0	PD	Z	DC	C	0001 1xxx	000q quuu	
84h ⁽¹⁾	FSR	Indirect data memory address pointer								xxxx xxxx	uuuu uuuu	
85h	TRISA	—	—	PORTA Data Direction Register						--11 1111	--11 1111	
86h	TRISB	PORTB Data Direction Register								1111 1111	1111 1111	
87h	TRISC	PORTC Data Direction Register								1111 1111	1111 1111	
88h ⁽⁵⁾	TRISD	PORTD Data Direction Register								1111 1111	1111 1111	
89h ⁽⁵⁾	TRISE	IBF	OBF	IBOV	PSPMODE	—	PORTE Data Direction Bits				0000 -111	0000 -111
8Ah ^(1,2)	PCLATH	—	—	—	Write Buffer for the upper 5 bits of the Program Counter					--0 0000	--0 0000	
8Bh ⁽¹⁾	INTCON	GIE	PEIE	TOIE	INTE	RBIE	TOIF	INTF	RBIF	0000 000x	0000 000u	
8Ch	PIE1	PSPIE ⁽⁶⁾	(4)	RCIE	TXIE	SSPIE	CCP1IE	TMR2IE	TMR1IE	0000 0000	0000 0000	
8Dh	PIE2	—	—	—	—	—	—	—	CCP2IE	---- -0	---- -0	
8Eh	PCON	—	—	—	—	—	—	POR	BOR	---- -qq	---- -uu	
8Fh	—	Unimplemented								—	—	
90h	—	Unimplemented								—	—	
91h	—	Unimplemented								—	—	
92h	PR2	Timer2 Period Register								1111 1111	1111 1111	
93h	SSPADD	Synchronous Serial Port (I ² C mode) Address Register								0000 0000	0000 0000	
94h	SSPSTAT	SMP	CKE	D/A	P	S	R/W	UA	BF	0000 0000	0000 0000	
95h	—	Unimplemented								—	—	
96h	—	Unimplemented								—	—	
97h	—	Unimplemented								—	—	
98h	TXSTA	CSRC	TX9	TXEN	SYNC	—	BRGH	TRMT	TX9D	0000 -010	0000 -010	
99h	SPBRG	Baud Rate Generator Register								0000 0000	0000 0000	
9Ah	—	Unimplemented								—	—	
9Bh	—	Unimplemented								—	—	
9Ch	—	Unimplemented								—	—	
9Dh	—	Unimplemented								—	—	
9Eh	—	Unimplemented								—	—	
9Fh	—	Unimplemented								—	—	

Legend: x = unknown, u = unchanged, q = value depends on condition, - = unimplemented location read as '0'.
Shaded locations are unimplemented, read as '0'.

Note 1: These registers can be addressed from any bank.

- The upper byte of the Program Counter (PC) is not directly accessible. PCLATH is a holding register for the PC whose contents are transferred to the upper byte of the program counter. (PC<12:8>)
- Other (non power-up) resets include external reset through MCLR and the Watchdog Timer reset.
- PIE1<6> and PIR1<6> are reserved on the PIC16C66/67, always maintain these bits clear.
- PORTD, PORTE, TRISD, and TRISE are not implemented on the PIC16C66, read as '0'.
- PSPIF (PIR1<7>) and PSPIE (PIE1<7>) are reserved on the PIC16C66, maintain these bits clear.

PIC16C6X

TABLE 4-6: SPECIAL FUNCTION REGISTERS FOR THE PIC16C66/67 (Cont'd)

Address	Name	Bit 7	Bit 6	Bit 5	Bit 4	Bit 3	Bit 2	Bit 1	Bit 0	Value on: POR, BOR	Value on all other resets ⁽³⁾
Bank 2											
100h ⁽¹⁾	INDF	Addressing this location uses contents of FSR to address data memory (not a physical register)								0000 0000	0000 0000
101h	TMR0	Timer0 module's register								xxxx xxxx	uuuu uuuu
102h ⁽¹⁾	PCL	Program Counter's (PC) Least Significant Byte								0000 0000	0000 0000
103h ⁽¹⁾	STATUS	IRP	RP1	RP0	\overline{TO}	\overline{PD}	Z	DC	C	0001 1xxx	000q quuu
104h ⁽¹⁾	FSR	Indirect data memory address pointer								xxxx xxxx	uuuu uuuu
105h	—	Unimplemented								—	—
106h	PORTB	PORTB Data Latch when written: PORTB pins when read								xxxx xxxx	uuuu uuuu
107h	—	Unimplemented								—	—
108h	—	Unimplemented								—	—
109h	—	Unimplemented								—	—
10Ah ^(1,2)	PCLATH	—	—	—	Write Buffer for the upper 5 bits of the Program Counter					---0 0000	---0 0000
10Bh ⁽¹⁾	INTCON	GIE	PEIE	T0IE	INTE	RBIE	T0IF	INTF	RBFIF	0000 000x	0000 000u
10Ch-10Fh	—	Unimplemented								—	—
Bank 3											
180h ⁽¹⁾	INDF	Addressing this location uses contents of FSR to address data memory (not a physical register)								0000 0000	0000 0000
181h	OPTION	RBP \overline{U}	INTEDG	T0CS	T0SE	PSA	PS2	PS1	PS0	1111 1111	1111 1111
182h ⁽¹⁾	PCL	Program Counter's (PC) Least Significant Byte								0000 0000	0000 0000
183h ⁽¹⁾	STATUS	IRP	RP1	RP0	\overline{TO}	\overline{PD}	Z	DC	C	0001 1xxx	000q quuu
184h ⁽¹⁾	FSR	Indirect data memory address pointer								xxxx xxxx	uuuu uuuu
185h	—	Unimplemented								—	—
186h	TRISB	PORTB Data Direction Register								1111 1111	1111 1111
187h	—	Unimplemented								—	—
188h	—	Unimplemented								—	—
189h	—	Unimplemented								—	—
18Ah ^(1,2)	PCLATH	—	—	—	Write Buffer for the upper 5 bits of the Program Counter					---0 0000	---0 0000
18Bh ⁽¹⁾	INTCON	GIE	PEIE	T0IE	INTE	RBIE	T0IF	INTF	RBFIF	0000 000x	0000 000u
18Ch-19Fh	—	Unimplemented								—	—

Legend: x = unknown, u = unchanged, q = value depends on condition, - = unimplemented location read as '0'.
Shaded locations are unimplemented, read as '0'.

Note 1: These registers can be addressed from any bank.

- The upper byte of the Program Counter (PC) is not directly accessible. PCLATH is a holding register for the PC whose contents are transferred to the upper byte of the program counter. (PC<12:8>)
- Other (non power-up) resets include external reset through \overline{MCLR} and the Watchdog Timer reset.
- PIE1<6> and PIR1<6> are reserved on the PIC16C66/67, always maintain these bits clear.
- PORTD, PORTE, TRISD, and TRISE are not implemented on the PIC16C66, read as '0'.
- PSPIF (PIR1<7>) and PSPIE (PIE1<7>) are reserved on the PIC16C66, maintain these bits clear.

4.2.2.1 STATUS REGISTER

Applicable Devices							
61	62	62A	R62	63	R63	64	64A
R64	65	65A	R65	66	67		

The STATUS register, shown in Figure 4-9, contains the arithmetic status of the ALU, the RESET status and the bank select bits for data memory.

The STATUS register can be the destination for any instruction, as with any other register. If the STATUS register is the destination for an instruction that affects the Z, DC or C bits, then the write to these three bits is disabled. These bits are set or cleared according to the device logic. Furthermore, the \overline{TO} and \overline{PD} bits are not writable. Therefore, the result of an instruction with the STATUS register as destination may be different than intended.

For example, CLRF STATUS will clear the upper-three bits and set the Z bit. This leaves the STATUS register as 000u u1uu (where u = unchanged).

It is recommended, therefore, that only BCF, BSF, SWAPF and MOVWF instructions are used to alter the STATUS register because these instructions do not affect the Z, C or DC bits from the STATUS register. For other instructions, not affecting any status bits, see the "Instruction Set Summary."

Note 1: For those devices that do not use bits IRP and RP1 (STATUS<7:6>), maintain these bits clear to ensure upward compatibility with future products.

Note 2: The C and DC bits operate as a borrow and digit borrow bit, respectively, in subtraction. See the SUBLW and SUBWF instructions for examples.

FIGURE 4-9: STATUS REGISTER (ADDRESS 03h, 83h, 103h, 183h)

R/W-0	R/W-0	R/W-0	R-1	R-1	R/W-x	R/W-x	R/W-x	
IRP	RP1	RP0	\overline{TO}	\overline{PD}	Z	DC	C	
bit7								bit0
<p>bit 7: IRP: Register Bank Select bit (used for indirect addressing) 1 = Bank 2, 3 (100h - 1FFh) 0 = Bank 0, 1 (00h - FFh)</p> <p>bit 6-5: RP1:RP0: Register Bank Select bits (used for direct addressing) 11 = Bank 3 (180h - 1FFh) 10 = Bank 2 (100h - 17Fh) 01 = Bank 1 (80h - FFh) 00 = Bank 0 (00h - 7Fh) Each bank is 128 bytes.</p> <p>bit 4: \overline{TO}: Time-out bit 1 = After power-up, CLRWDI instruction, or SLEEP instruction 0 = A WDT time-out occurred</p> <p>bit 3: \overline{PD}: Power-down bit 1 = After power-up or by the CLRWDI instruction 0 = By execution of the SLEEP instruction</p> <p>bit 2: Z: Zero bit 1 = The result of an arithmetic or logic operation is zero 0 = The result of an arithmetic or logic operation is not zero</p> <p>bit 1: DC: Digit carry/borrow bit (for ADDWF, ADDLW, SUBLW, and SUBWF instructions) (For borrow the polarity is reversed). 1 = A carry-out from the 4th low order bit of the result occurred 0 = No carry-out from the 4th low order bit of the result</p> <p>bit 0: C: Carry/borrow bit (for ADDWF, ADDLW, SUBLW, and SUBWF instructions) (For borrow the polarity is reversed). 1 = A carry-out from the most significant bit of the result occurred 0 = No carry-out from the most significant bit of the result Note: a subtraction is executed by adding the two's complement of the second operand. For rotate (RRF, RLF) instructions, this bit is loaded with either the high or low order bit of the source register.</p>								

R = Readable bit
 W = Writable bit
 - n = Value at POR reset
 x = unknown

PIC16C6X

4.2.2.2 OPTION REGISTER

Applicable Devices							
61	62	62A	63	64	64A	65	65A
66	67						

Note: To achieve a 1:1 prescaler assignment for TMR0 register, assign the prescaler to the Watchdog Timer.

The OPTION register is a readable and writable register which contains various control bits to configure the TMR0/WDT prescaler, the external INT interrupt, TMR0, and the weak pull-ups on PORTB.

FIGURE 4-10: OPTION REGISTER (ADDRESS 81h, 181h)



4.2.2.3 INTCON REGISTER

Applicable Devices

61|62|62A|63|63A|64|64A|65|65A|66|67

The INTCON Register is a readable and writable register which contains the various enable and flag bits for the TMR0 register overflow, RB port change and external RB0/INT pin interrupts.

Note: Interrupt flag bits get set when an interrupt condition occurs regardless of the state of its corresponding enable bit or the global enable bit, GIE (INTCON<7>).

FIGURE 4-11: INTCON REGISTER (ADDRESS 0Bh, 8Bh, 10Bh 18Bh)



PIC16C6X

4.2.2.4 PIE1 REGISTER

Applicable Devices

61|62|62A|R62|63|R63|64|64A|R64|65|65A|R65|66|67

This register contains the individual enable bits for the peripheral interrupts.

Note: Bit PEIE (INTCON<6>) must be set to enable any peripheral interrupt.

FIGURE 4-12: PIE1 REGISTER FOR PIC16C62/62A/R62 (ADDRESS 8Ch)



FIGURE 4-13: PIE1 REGISTER FOR PIC16C63/R63/66 (ADDRESS 8Ch)

	R/W-0	R/W-0	R/W-0	R/W-0	R/W-0	R/W-0	R/W-0		
bit7	—	—	RCIE	TXIE	SSPIE	CCP1IE	TMR2IE	TMR1IE	bit0

R = Readable bit
W = Writable bit
U = Unimplemented bit, read as '0'
-n = Value at POR reset

bit 7-6: **Reserved:** Always maintain these bits clear.

bit 5: **RCIE:** USART Receive Interrupt Enable bit
1 = Enables the USART receive interrupt
0 = Disables the USART receive interrupt

bit 4: **TXIE:** USART Transmit Interrupt Enable bit
1 = Enables the USART transmit interrupt
0 = Disables the USART transmit interrupt

bit 3: **SSPIE:** Synchronous Serial Port Interrupt Enable bit
1 = Enables the SSP interrupt
0 = Disables the SSP interrupt

bit 2: **CCP1IE:** CCP1 Interrupt Enable bit
1 = Enables the CCP1 interrupt
0 = Disables the CCP1 interrupt

bit 1: **TMR2IE:** TMR2 to PR2 Match Interrupt Enable bit
1 = Enables the TMR2 to PR2 match interrupt
0 = Disables the TMR2 to PR2 match interrupt

bit 0: **TMR1IE:** TMR1 Overflow Interrupt Enable bit
1 = Enables the TMR1 overflow interrupt
0 = Disables the TMR1 overflow interrupt

FIGURE 4-14: PIE1 REGISTER FOR PIC16C64/64A/R64 (ADDRESS 8Ch)

	R/W-0	R/W-0	U-0	U-0	R/W-0	R/W-0	R/W-0	R/W-0	
bit7	PSPIE	—	—	—	SSPIE	CCP1IE	TMR2IE	TMR1IE	bit0

R = Readable bit
W = Writable bit
U = Unimplemented bit, read as '0'
-n = Value at POR reset

bit 7: **PSPIE:** Parallel Slave Port Read/Write Interrupt Enable bit
1 = Enables the PSP read/write interrupt
0 = Disables the PSP read/write interrupt

bit 6: **Reserved:** Always maintain this bit clear.

bit 5-4: **Unimplemented:** Read as '0'

bit 3: **SSPIE:** Synchronous Serial Port Interrupt Enable bit
1 = Enables the SSP interrupt
0 = Disables the SSP interrupt

bit 2: **CCP1IE:** CCP1 Interrupt Enable bit
1 = Enables the CCP1 interrupt
0 = Disables the CCP1 interrupt

bit 1: **TMR2IE:** TMR2 to PR2 Match Interrupt Enable bit
1 = Enables the TMR2 to PR2 match interrupt
0 = Disables the TMR2 to PR2 match interrupt

bit 0: **TMR1IE:** TMR1 Overflow Interrupt Enable bit
1 = Enables the TMR1 overflow interrupt
0 = Disables the TMR1 overflow interrupt

PIC16C6X

FIGURE 4-15: PIE1 REGISTER FOR PIC16C65/65A/R65/67 (ADDRESS 8Ch)

R/W-0	R/W-0	R/W-0	R/W-0	R/W-0	R/W-0	R/W-0	R/W-0
PSPIE	—	RCIE	TXIE	SSPIE	CCP1IE	TMR2IE	TMR1IE
bit7							bit0

R = Readable bit
W = Writable bit
U = Unimplemented bit, read as '0'
-n = Value at POR reset

bit 7: **PSPIE**: Parallel Slave Port Read/Write Interrupt Enable bit
1 = Enables the PSP read/write interrupt
0 = Disables the PSP read/write interrupt

bit 6: **Reserved**: Always maintain this bit clear.

bit 5: **RCIE**: USART Receive Interrupt Enable bit
1 = Enables the USART receive interrupt
0 = Disables the USART receive interrupt

bit 4: **TXIE**: USART Transmit Interrupt Enable bit
1 = Enables the USART transmit interrupt
0 = Disables the USART transmit interrupt

bit 3: **SSPIE**: Synchronous Serial Port Interrupt Enable bit
1 = Enables the SSP interrupt
0 = Disables the SSP interrupt

bit 2: **CCP1IE**: CCP1 Interrupt Enable bit
1 = Enables the CCP1 interrupt
0 = Disables the CCP1 interrupt

bit 1: **TMR2IE**: TMR2 to PR2 Match Interrupt Enable bit
1 = Enables the TMR2 to PR2 match interrupt
0 = Disables the TMR2 to PR2 match interrupt

bit 0: **TMR1IE**: TMR1 Overflow Interrupt Enable bit
1 = Enables the TMR1 overflow interrupt
0 = Disables the TMR1 overflow interrupt

4.2.2.5 PIR1 REGISTER

Applicable Devices

61|62|62A|R62|63|R63|64|64A|R64|65|65A|R65|66|67

This register contains the individual flag bits for the peripheral interrupts.

Note: Interrupt flag bits get set when an interrupt condition occurs regardless of the state of its corresponding enable bit or the global enable bit, GIE (INTCON<7>). User software should ensure the appropriate interrupt flag bits are clear prior to enabling an interrupt.

FIGURE 4-16: PIR1 REGISTER FOR PIC16C62/62A/R62 (ADDRESS 0Ch)

R/W-0	R/W-0	U-0	U-0	R/W-0	R/W-0	R/W-0	R/W-0		
—	—	—	—	SSPIF	CCP1IF	TMR2IF	TMR1IF		
bit7				bit0					
<p>bit 7-6: Reserved: Always maintain these bits clear.</p> <p>bit 5-4: Unimplemented: Read as '0'</p> <p>bit 3: SSPIF: Synchronous Serial Port Interrupt Flag bit 1 = The transmission/reception is complete (must be cleared in software) 0 = Waiting to transmit/receive</p> <p>bit 2: CCP1IF: CCP1 Interrupt Flag bit <u>Capture Mode</u> 1 = A TMR1 register capture occurred (must be cleared in software) 0 = No TMR1 register capture occurred <u>Compare Mode</u> 1 = A TMR1 register compare match occurred (must be cleared in software) 0 = No TMR1 register compare match occurred <u>PWM Mode</u> Unused in this mode</p> <p>bit 1: TMR2IF: TMR2 to PR2 Match Interrupt Flag bit 1 = TMR2 to PR2 match occurred (must be cleared in software) 0 = No TMR2 to PR2 match occurred</p> <p>bit 0: TMR1IF: TMR1 Overflow Interrupt Flag bit 1 = TMR1 register overflow occurred (must be cleared in software) 0 = No TMR1 register overflow occurred</p>								<p>R = Readable bit W = Writable bit U = Unimplemented bit, read as '0' - n = Value at POR reset</p>	
<p>Interrupt flag bits get set when an interrupt condition occurs regardless of the state of its corresponding enable bit or the global enable bit, GIE (INTCON<7>). User software should ensure the appropriate interrupt flag bits are clear prior to enabling an interrupt.</p>									

PIC16C6X

FIGURE 4-17: PIR1 REGISTER FOR PIC16C63/R63/66 (ADDRESS 0Ch)

R/W-0	R/W-0	R-0	R-0	R/W-0	R/W-0	R/W-0	R/W-0
—	—	RCIF	TXIF	SSPIF	CCP1IF	TMR2IF	TMR1IF
bit7							bit0

R = Readable bit
W = Writable bit
U = Unimplemented bit, read as '0'
-n = Value at POR reset

bit 7-6: **Reserved:** Always maintain these bits clear.

bit 5: **RCIF:** USART Receive Interrupt Flag bit
1 = The USART receive buffer is full (cleared by reading RCREG)
0 = The USART receive buffer is empty

bit 4: **TXIF:** USART Transmit Interrupt Flag bit
1 = The USART transmit buffer is empty (cleared by writing to TXREG)
0 = The USART transmit buffer is full

bit 3: **SSPIF:** Synchronous Serial Port Interrupt Flag bit
1 = The transmission/reception is complete (must be cleared in software)
0 = Waiting to transmit/receive

bit 2: **CCP1IF:** CCP1 Interrupt Flag bit
Capture Mode
1 = A TMR1 register capture occurred (must be cleared in software)
0 = No TMR1 register capture occurred
Compare Mode
1 = A TMR1 register compare match occurred (must be cleared in software)
0 = No TMR1 register compare match occurred
PWM Mode
Unused in this mode

bit 1: **TMR2IF:** TMR2 to PR2 Match Interrupt Flag bit
1 = TMR2 to PR2 match occurred (must be cleared in software)
0 = No TMR2 to PR2 match occurred

bit 0: **TMR1IF:** TMR1 Overflow Interrupt Flag bit
1 = TMR1 register overflow occurred (must be cleared in software)
0 = No TMR1 register overflow occurred

Interrupt flag bits get set when an interrupt condition occurs regardless of the state of its corresponding enable bit or the global enable bit, GIE (INTCON<7>). User software should ensure the appropriate interrupt flag bits are clear prior to enabling an interrupt.

FIGURE 4-18: PIR1 REGISTER FOR PIC16C64/64A/R64 (ADDRESS 0Ch)

R/W-0	R/W-0	U-0	U-0	R/W-0	R/W-0	R/W-0	R/W-0
PSPIF	—	—	—	SSPIF	CCP1IF	TMR2IF	TMR1IF
bit7				bit0			

R = Readable bit
W = Writable bit
U = Unimplemented bit, read as '0'
- n = Value at POR reset

bit 7: **PSPIF:** Parallel Slave Port Interrupt Flag bit
1 = A read or a write operation has taken place (must be cleared in software)
0 = No read or write operation has taken place

bit 6: **Reserved:** Always maintain this bit clear.

bit 5-4: **Unimplemented:** Read as '0'

bit 3: **SSPIF:** Synchronous Serial Port Interrupt Flag bit
1 = The transmission/reception is complete (must be cleared in software)
0 = Waiting to transmit/receive

bit 2: **CCP1IF:** CCP1 Interrupt Flag bit
Capture Mode
1 = A TMR1 register capture occurred (must be cleared in software)
0 = No TMR1 register capture occurred
Compare Mode
1 = A TMR1 register compare match occurred (must be cleared in software)
0 = No TMR1 register compare match occurred
PWM Mode
Unused in this mode

bit 1: **TMR2IF:** TMR2 to PR2 Match Interrupt Flag bit
1 = TMR2 to PR2 match occurred (must be cleared in software)
0 = No TMR2 to PR2 match occurred

bit 0: **TMR1IF:** TMR1 Overflow Interrupt Flag bit
1 = TMR1 register overflow occurred (must be cleared in software)
0 = No TMR1 register occurred

Interrupt flag bits get set when an interrupt condition occurs regardless of the state of its corresponding enable bit or the global enable bit, GIE (INTCON<7>). User software should ensure the appropriate interrupt flag bits are clear prior to enabling an interrupt.

PIC16C6X

FIGURE 4-19: PIR1 REGISTER FOR PIC16C65/65A/R65/67 (ADDRESS 0Ch)

R/W-0	R/W-0	R-0	R-0	R/W-0	R/W-0	R/W-0	R/W-0	
PSPIF	—	RCIF	TXIF	SSPIF	CCP1IF	TMR2IF	TMR1IF	
bit7								bit0

R = Readable bit
W = Writable bit
U = Unimplemented bit, read as '0'
-n = Value at POR reset

bit 7: **PSPIF**: Parallel Slave Port Interrupt Flag bit
1 = A read or a write operation has taken place (must be cleared in software)
0 = No read or write operation has taken place

bit 6: **Reserved**: Always maintain this bit clear.

bit 5: **RCIF**: USART Receive Interrupt Flag bit
1 = The USART receive buffer is full (cleared by reading RCREG)
0 = The USART receive buffer is empty

bit 4: **TXIF**: USART Transmit Interrupt Flag bit
1 = The USART transmit buffer is empty (cleared by writing to TXREG)
0 = The USART transmit buffer is full

bit 3: **SSPIF**: Synchronous Serial Port Interrupt Flag bit
1 = The transmission/reception is complete (must be cleared in software)
0 = Waiting to transmit/receive

bit 2: **CCP1IF**: CCP1 Interrupt Flag bit
Capture Mode
1 = A TMR1 register capture occurred (must be cleared in software)
0 = No TMR1 register capture occurred
Compare Mode
1 = A TMR1 register compare match occurred (must be cleared in software)
0 = No TMR1 register compare match occurred
PWM Mode
Unused in this mode

bit 1: **TMR2IF**: TMR2 to PR2 Match Interrupt Flag bit
1 = TMR2 to PR2 match occurred (must be cleared in software)
0 = No TMR2 to PR2 match occurred

bit 0: **TMR1IF**: TMR1 Overflow Interrupt Flag bit
1 = TMR1 register overflow occurred (must be cleared in software)
0 = No TMR1 register overflow occurred

Interrupt flag bits get set when an interrupt condition occurs regardless of the state of its corresponding enable bit or the global enable bit, GIE (INTCON<7>). User software should ensure the appropriate interrupt flag bits are clear prior to enabling an interrupt.

4.2.2.6 PIE2 REGISTER

Applicable Devices													
61	62	62A	R62	63	R63	64	64A	R64	65	65A	R65	66	67

This register contains the CCP2 interrupt enable bit.

FIGURE 4-20: PIE2 REGISTER (ADDRESS 8Dh)

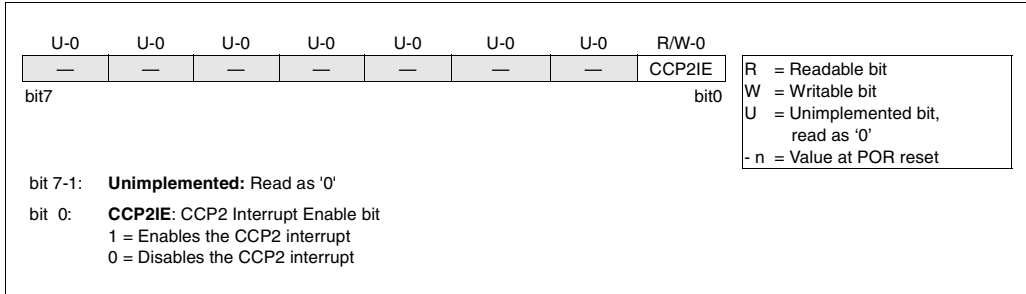

PIC16C6X

4.2.2.7 PIR2 REGISTER

Applicable Devices													
61	62	62A	R62	63	R63	64	64A	R64	65	65A	R65	66	67

This register contains the CCP2 interrupt flag bit.

Note: Interrupt flag bits get set when an interrupt condition occurs regardless of the state of its corresponding enable bit or the global enable bit, GIE (INTCON<7>). User software should ensure the appropriate interrupt flag bits are clear prior to enabling an interrupt.

FIGURE 4-21: PIR2 REGISTER (ADDRESS 0Dh)



4.2.2.8 PCON REGISTER

Applicable Devices													
61	62	62A	R62	63	R63	64	64A	R64	65	65A	R65	66	67

The Power Control register (PCON) contains a flag bit to allow differentiation between a Power-on Reset to an external \overline{MCLR} reset or WDT reset. Those devices with brown-out detection circuitry contain an additional bit to differentiate a Brown-out Reset condition from a Power-on Reset condition.

Note: \overline{BOR} is unknown on Power-on Reset. It must then be set by the user and checked on subsequent resets to see if \overline{BOR} is clear, indicating a brown-out has occurred. The \overline{BOR} status bit is a "don't care" and is not necessarily predictable if the brown-out circuit is disabled (by clearing the BODEN bit in the Configuration word).

FIGURE 4-22: PCON REGISTER FOR PIC16C62/64/65 (ADDRESS 8Eh)

U-0	U-0	U-0	U-0	U-0	U-0	R/W-0	R/W-q
—	—	—	—	—	—	POR	—
bit7							bit0

R = Readable bit
 W = Writable bit
 U = Unimplemented bit, read as '0'
 - n = Value at POR reset
 q = value depends on conditions

bit 7-2: **Unimplemented:** Read as '0'
 bit 1: **POR:** Power-on Reset Status bit
 1 = No Power-on Reset occurred
 0 = A Power-on Reset occurred (must be set in software after a Power-on Reset occurs)
 bit 0: **Reserved**
 This bit should be set upon a Power-on Reset by user software and maintained as set. Use of this bit as a general purpose read/write bit is not recommended, since this may affect upward compatibility with future products.

FIGURE 4-23: PCON REGISTER FOR PIC16C62A/R62/63/R63/64A/R64/65A/R65/66/67 (ADDRESS 8Eh)

U-0	U-0	U-0	U-0	U-0	U-0	R/W-0	R/W-q
—	—	—	—	—	—	POR	\overline{BOR}
bit7							bit0

R = Readable bit
 W = Writable bit
 U = Unimplemented bit, read as '0'
 - n = Value at POR reset
 q = value depends on conditions

bit 7-2: **Unimplemented:** Read as '0'
 bit 1: **POR:** Power-on Reset Status bit
 1 = No Power-on Reset occurred
 0 = A Power-on Reset occurred (must be set in software after a Power-on Reset occurs)
 bit 0: **\overline{BOR} :** Brown-out Reset Status bit
 1 = No Brown-out Reset occurred
 0 = A Brown-out Reset occurred (must be set in software after a Brown-out Reset occurs)

PIC16C6X

4.3 PCL and PCLATH

Applicable Devices													
61	62	62A	R62	63	R63	64	64A	R64	65	65A	R65	66	67

The program counter (PC) is 13-bits wide. The low byte comes from the PCL register, which is a readable and writable register. The upper bits (PC<12:8>) are not readable, but are indirectly writable through the PCLATH register. On any reset, the upper bits of the PC will be cleared. Figure 4-24 shows the two situations for the loading of the PC. The upper example in the figure shows how the PC is loaded on a write to PCL (PCLATH<4:0> → PCH). The lower example in the figure shows how the PC is loaded during a CALL or GOTO instruction (PCLATH<4:3> → PCH).

FIGURE 4-24: LOADING OF PC IN DIFFERENT SITUATIONS



4.3.1 COMPUTED GOTO

A computed GOTO is accomplished by adding an offset to the program counter (`ADDWF PCL`). When doing a table read using a computed GOTO method, care should be exercised if the table location crosses a PCL memory boundary (each 256 word block). Refer to the application note "Implementing a Table Read" (AN556).

4.3.2 STACK

The PIC16CXX family has an 8 deep x 13-bit wide hardware stack. The stack space is not part of either program or data space and the stack pointer is not readable or writable. The PC is PUSHed onto the stack when a CALL instruction is executed or an interrupt causes a branch. The stack is POPed in the event of a RETURN, RETLW or a RETFIE instruction execution. PCLATH is not affected by a PUSH or a POP operation.

The stack operates as a circular buffer. This means that after the stack has been PUSHed eight times, the ninth push overwrites the value that was stored from the first push. The tenth push overwrites the second push (and so on).

Note 1: There are no status bits to indicate stack overflows or stack underflow conditions.

Note 2: There are no instructions mnemonics called PUSH or POP. These are actions that occur from the execution of the CALL, RETURN, RETLW, and RETFIE instructions, or the vectoring to an interrupt address

4.4 Program Memory Paging

Applicable Devices													
61	62	62A	R62	63	R63	64	64A	R64	65	65A	R65	66	67

PIC16C6X devices are capable of addressing a continuous 8K word block of program memory. The CALL and GOTO instructions provide only 11 bits of address to allow branching within any 2K program memory page. When doing a CALL or GOTO instruction the upper two bits of the address are provided by PCLATH<4:3>. When doing a CALL or GOTO instruction, the user must ensure that the page select bits are programmed so that the desired program memory page is addressed. If a return from a CALL instruction (or interrupt) is executed, the entire 13-bit PC is pushed onto the stack. Therefore, manipulation of the PCLATH<4:3> bits are not required for the return instructions (which POPs the address from the stack).

Note: PIC16C6X devices with 4K or less of program memory ignore paging bit PCLATH<4>. The use of PCLATH<4> as a general purpose read/write bit is not recommended since this may affect upward compatibility with future products.

Example 4-1 shows the calling of a subroutine in page 1 of the program memory. This example assumes that the PCLATH is saved and restored by the interrupt service routine (if interrupts are used).

EXAMPLE 4-1: CALL OF A SUBROUTINE IN PAGE 1 FROM PAGE 0

```

ORG 0x500
BSF   PCLATH,3 ;Select page 1 (800h-FFFh)
BCF   PCLATH,4 ;Only on >4K devices
CALL  SUB1_P1  ;Call subroutine in
:           ;page 1 (800h-FFFh)
:
:
ORG 0x900
SUB1_P1: ;called subroutine
:       ;page 1 (800h-FFFh)
:
RETURN ;return to Call subroutine
:     ;in page 0 (000h-7FFh)
    
```

4.5 Indirect Addressing, INDF and FSR Registers

Applicable Devices													
61	62	62A	R62	63	R63	64	64A	R64	65	65A	R65	66	67

The INDF register is not a physical register. Addressing the INDF register will cause indirect addressing.

Indirect addressing is possible by using the INDF register. Any instruction using the INDF register actually accesses the register pointed to by the File Select Register, FSR. Reading the INDF register itself indirectly (FSR = '0') will produce 00h. Writing to the INDF register indirectly results in a no-operation (although status bits may be affected). An effective 9-bit address is obtained by concatenating the 8-bit FSR register and the IRP bit (STATUS<7>), as shown in Figure 4-25.

A simple program to clear RAM location 20h-2Fh using indirect addressing is shown in Example 4-2.

EXAMPLE 4-2: INDIRECT ADDRESSING

```

        movlw 0x20 ;initialize pointer
        movwf FSR ; to RAM
NEXT    clrf  INDF ;clear INDF register
        incf  FSR,F ;inc pointer
        btfs  FSR,4 ;all done?
        goto  NEXT ;NO, clear next

CONTINUE
:           ;YES, continue
    
```

FIGURE 4-25: DIRECT/INDIRECT ADDRESSING



PIC16C6X

NOTES:

5.0 I/O PORTS

Applicable Devices													
61	62	62A	R62	63	R63	64	64A	R64	65	65A	R65	66	67

Some pins for these I/O ports are multiplexed with an alternate function(s) for the peripheral features on the device. In general, when a peripheral is enabled, that pin may not be used as a general purpose I/O pin.

5.1 PORTA and TRISA Register

Applicable Devices													
61	62	62A	R62	63	R63	64	64A	R64	65	65A	R65	66	67

All devices have a 6-bit wide PORTA, except for the PIC16C61 which has a 5-bit wide PORTA.

Pin RA4/T0CKI is a Schmitt Trigger input and an open drain output. All other RA port pins have TTL input levels and full CMOS output drivers. All pins have data direction bits (TRIS registers) which can configure these pins as output or input.

Setting a bit in the TRISA register puts the corresponding output driver in a hi-impedance mode. Clearing a bit in the TRISA register puts the contents of the output latch on the selected pin.

Reading PORTA register reads the status of the pins whereas writing to it will write to the port latch. All write operations are read-modify-write operations. Therefore, a write to a port implies that the port pins are read, this value is modified, and then written to the port data latch.

Pin RA4 is multiplexed with Timer0 module clock input to become the RA4/T0CKI pin.

EXAMPLE 5-1: INITIALIZING PORTA

```
BCF STATUS, RP0 ;
BCF STATUS, RP1 ; PIC16C66/67 only
CLRF PORTA      ; Initialize PORTA by
                ; clearing output
                ; data latches
BSF STATUS, RP0 ; Select Bank 1
MOVLW 0xCF      ; Value used to
                ; initialize data
                ; direction
MOVWF TRISA     ; Set RA<3:0> as inputs
                ; RA<5:4> as outputs
                ; TRISA<7:6> are always
                ; read as '0'.
```

FIGURE 5-1: BLOCK DIAGRAM OF THE RA3:RA0 PINS AND THE RA5 PIN



FIGURE 5-2: BLOCK DIAGRAM OF THE RA4/T0CKI PIN



PIC16C6X

TABLE 5-1: PORTA FUNCTIONS

Name	Bit#	Buffer Type	Function
RA0	bit0	TTL	Input/output
RA1	bit1	TTL	Input/output
RA2	bit2	TTL	Input/output
RA3	bit3	TTL	Input/output
RA4/T0CKI	bit4	ST	Input/output or external clock input for Timer0. Output is open drain type.
RA5/ \overline{SS} (1)	bit5	TTL	Input/output or slave select input for synchronous serial port.

Legend: TTL = TTL input, ST = Schmitt Trigger input

Note 1: The PIC16C61 does not have PORTA<5> or TRISA<5>, read as '0'.

TABLE 5-2: REGISTERS/BITS ASSOCIATED WITH PORTA

Address	Name	Bit 7	Bit 6	Bit 5	Bit 4	Bit 3	Bit 2	Bit 1	Bit 0	Value on: POR, BOR	Value on all other resets
05h	PORTA	—	—	RA5 ⁽¹⁾	RA4	RA3	RA2	RA1	RA0	--xx xxxx	--uu uuuu
85h	TRISA	—	—	PORTA Data Direction Register ⁽¹⁾						--11 1111	--11 1111

Legend: x = unknown, u = unchanged, - = unimplemented locations read as '0'. Shaded cells are not used by PORTA.

Note 1: PORTA<5> and TRISA<5> are not implemented on the PIC16C61, read as '0'.

5.2 PORTB and TRISB Register

Applicable Devices													
61	62	62A	R62	63	R63	64	64A	R64	65	65A	R65	66	67

PORTB is an 8-bit wide bi-directional port. The corresponding data direction register is TRISB. Setting a bit in the TRISB register puts the corresponding output driver in a hi-impedance mode. Clearing a bit in the TRISB register puts the contents of the output latch on the selected pin(s).

EXAMPLE 5-2: INITIALIZING PORTB

```
BCF    STATUS, RP0 ;
CLRFB PORTB       ; Initialize PORTB by
                  ; clearing output
                  ; data latches

BSF    STATUS, RP0 ; Select Bank 1
MOVLW 0xCF        ; Value used to
                  ; initialize data
                  ; direction
MOVWF  TRISB      ; Set RB<3:0> as inputs
                  ; RB<5:4> as outputs
                  ; RB<7:6> as inputs
```

Each of the PORTB pins has a weak internal pull-up. A single control bit can turn on all the pull-ups. This is performed by clearing bit $\overline{\text{RBP}}\overline{\text{U}}$ (OPTION<7>). The weak pull-up is automatically turned off when the port pin is configured as an output. The pull-ups are also disabled on a Power-on Reset.

Four of PORTB's pins, RB7:RB4, have an interrupt on change feature. Only pins configured as inputs can cause this interrupt to occur (i.e., any RB7:RB4 pin configured as an output is excluded from the interrupt on change comparison). The input pins (of RB7:RB4) are compared with the old value latched on the last read of PORTB. The "mismatch" outputs of RB7:RB4 are OR'ed together to generate the RB port change interrupt with flag bit RBIF (INTCON<0>).

This interrupt can wake the device from SLEEP. The user, in the interrupt service routine, can clear the interrupt in the following manner:

- Any read or write of PORTB. This will end the mismatch condition.
- Clear flag bit RBIF.

A mismatch condition will continue to set flag bit RBIF. Reading PORTB will end the mismatch condition, and allow flag bit RBIF to be cleared.

This interrupt on mismatch feature, together with software configurable pull-ups on these four pins allow easy interface to a keypad and make it possible for wake-up on key-depression. Refer to the Embedded Control Handbook, Application Note, "Implementing Wake-up on Key Stroke" (AN552).

Note: For PIC16C61/62/64/65, if a change on the I/O pin should occur when a read operation is being executed (start of the Q2 cycle), then interrupt flag bit RBIF may not get set.

The interrupt on change feature is recommended for wake-up on key depression operation and operations where PORTB is only used for the interrupt on change feature. Polling of PORTB is not recommended while using the interrupt on change feature.

FIGURE 5-3: BLOCK DIAGRAM OF THE RB7:RB4 PINS FOR PIC16C61/62/64/65



PIC16C6X

FIGURE 5-4: BLOCK DIAGRAM OF THE RB7:RB4 PINS FOR PIC16C62A/63/R63/64A/65A/R65/66/67



FIGURE 5-5: BLOCK DIAGRAM OF THE RB3:RB0 PINS



TABLE 5-3: PORTB FUNCTIONS

Name	Bit#	Buffer Type	Function
RB0/INT	bit0	TTL/ST ⁽¹⁾	Input/output pin or external interrupt input. Internal software programmable weak pull-up.
RB1	bit1	TTL	Input/output pin. Internal software programmable weak pull-up.
RB2	bit2	TTL	Input/output pin. Internal software programmable weak pull-up.
RB3	bit3	TTL	Input/output pin. Internal software programmable weak pull-up.
RB4	bit4	TTL	Input/output pin (with interrupt on change). Internal software programmable weak pull-up.
RB5	bit5	TTL	Input/output pin (with interrupt on change). Internal software programmable weak pull-up.
RB6	bit6	TTL/ST ⁽²⁾	Input/output pin (with interrupt on change). Internal software programmable weak pull-up. Serial programming clock.
RB7	bit7	TTL/ST ⁽²⁾	Input/output pin (with interrupt on change). Internal software programmable weak pull-up. Serial programming data.

Legend: TTL = TTL input, ST = Schmitt Trigger input

Note 1: This buffer is a Schmitt Trigger input when configured as the external interrupt.

2: This buffer is a Schmitt Trigger input when used in serial programming mode.

TABLE 5-4: SUMMARY OF REGISTERS ASSOCIATED WITH PORTB

Address	Name	Bit 7	Bit 6	Bit 5	Bit 4	Bit 3	Bit 2	Bit 1	Bit 0	Value on: POR, BOR	Value on all other resets
06h, 106h	PORTB	RB7	RB6	RB5	RB4	RB3	RB2	RB1	RB0	xxxx xxxx	uuuu uuuuu
86h, 186h	TRISB	PORTB Data Direction Register								1111 1111	1111 1111
81h, 181h	OPTION	RBPUS	INTEDG	TOCS	T0SE	PSA	PS2	PS1	PS0	1111 1111	1111 1111

Legend: x = unknown, u = unchanged. Shaded cells are not used by PORTB.

5.3 PORTC and TRISC Register

Applicable Devices													
61	62	62A	R62	63	R63	64	64A	R64	65	65A	R65	66	67

PORTC is an 8-bit wide bi-directional port. Each pin is individually configurable as an input or output through the TRISC register. PORTC is multiplexed with several peripheral functions (Table 5-5). PORTC pins have Schmitt Trigger input buffers.

When enabling peripheral functions, care should be taken in defining TRIS bits for each PORTC pin. Some peripherals override the TRIS bit to make a pin an output, while other peripherals override the TRIS bit to make a pin an input. Since the TRIS bit override is in effect while the peripheral is enabled, read-modify-write instructions (BSF, BCF, XORWF) with TRISC as destination should be avoided. The user should refer to the corresponding peripheral section for the correct TRIS bit settings.

EXAMPLE 5-3: INITIALIZING PORTC

```
BCF    STATUS, RP0    ;
BCF    STATUS, RP1    ; PIC16C66/67 only
CLRF   PORTC          ; Initialize PORTC by
                        ; clearing output
                        ; data latches
BSF    STATUS, RP0    ; Select Bank 1
MOVLW  0xCF           ; Value used to
                        ; initialize data
                        ; direction
MOVWF  TRISC          ; Set RC<3:0> as inputs
                        ; RC<5:4> as outputs
                        ; RC<7:6> as inputs
```

FIGURE 5-6: PORTC BLOCK DIAGRAM



TABLE 5-5: PORTC FUNCTIONS FOR PIC16C62/64

Name	Bit#	Buffer Type	Function
RC0/T1OSI/T1CKI	bit0	ST	Input/output port pin or Timer1 oscillator input or Timer1 clock input
RC1/T1OSO	bit1	ST	Input/output port pin or Timer1 oscillator output
RC2/CCP1	bit2	ST	Input/output port pin or Capture1 input/Compare1 output/PWM1 output
RC3/SCK/SCL	bit3	ST	RC3 can also be the synchronous serial clock for both SPI and I ² C modes.
RC4/SDI/SDA	bit4	ST	RC4 can also be the SPI Data In (SPI mode) or data I/O (I ² C mode).
RC5/SDO	bit5	ST	Input/output port pin or synchronous serial port data output
RC6	bit6	ST	Input/output port pin
RC7	bit7	ST	Input/output port pin

Legend: ST = Schmitt Trigger input

PIC16C6X

TABLE 5-6: PORTC FUNCTIONS FOR PIC16C62A/R62/64A/R64

Name	Bit#	Buffer Type	Function
RC0/T1OSO/T1CKI	bit0	ST	Input/output port pin or Timer1 oscillator output or Timer1 clock input
RC1/T1OSI	bit1	ST	Input/output port pin or Timer1 oscillator input
RC2/CCP1	bit2	ST	Input/output port pin or Capture input/Compare output/PWM1 output
RC3/SCK/SCL	bit3	ST	RC3 can also be the synchronous serial clock for both SPI and I ² C modes.
RC4/SDI/SDA	bit4	ST	RC4 can also be the SPI Data In (SPI mode) or data I/O (I ² C mode).
RC5/SDO	bit5	ST	Input/output port pin or synchronous serial port data output
RC6	bit6	ST	Input/output port pin
RC7	bit7	ST	Input/output port pin

Legend: ST = Schmitt Trigger input

TABLE 5-7: PORTC FUNCTIONS FOR PIC16C63/R63/65/65A/R65/66/67

Name	Bit#	Buffer Type	Function
RC0/T1OSO/T1CKI	bit0	ST	Input/output port pin or Timer1 oscillator output or Timer1 clock input
RC1/T1OSI/CCP2	bit1	ST	Input/output port pin or Timer1 oscillator input or Capture2 input/Compare2 output/PWM2 output
RC2/CCP1	bit2	ST	Input/output port pin or Capture1 input/Compare1 output/PWM1 output
RC3/SCK/SCL	bit3	ST	RC3 can also be the synchronous serial clock for both SPI and I ² C modes.
RC4/SDI/SDA	bit4	ST	RC4 can also be the SPI Data In (SPI mode) or data I/O (I ² C mode).
RC5/SDO	bit5	ST	Input/output port pin or synchronous serial port data output
RC6/TX/CK	bit6	ST	Input/output port pin or USART Asynchronous Transmit, or USART Synchronous Clock
RC7/RX/DT	bit7	ST	Input/output port pin or USART Asynchronous Receive, or USART Synchronous Data

Legend: ST = Schmitt Trigger input

TABLE 5-8: SUMMARY OF REGISTERS ASSOCIATED WITH PORTC

Address	Name	Bit 7	Bit 6	Bit 5	Bit 4	Bit 3	Bit 2	Bit 1	Bit 0	Value on: POR, BOR	Value on all other resets
07h	PORTC	RC7	RC6	RC5	RC4	RC3	RC2	RC1	RC0	xxxx xxxx	uuuu uuuu
87h	TRISC	PORTC Data Direction Register								1111 1111	1111 1111

Legend: x = unknown, u = unchanged.

5.4 PORTD and TRISD Register

Applicable Devices													
61	62	62A	R62	63	R63	64	64A	R64	65	65A	R65	66	67

PORTD is an 8-bit port with Schmitt Trigger input buffers. Each pin is individually configurable as input or output.

PORTD can be configured as an 8-bit wide microprocessor port (parallel slave port) by setting control bit PSMODE (TRISE<4>). In this mode, the input buffers are TTL.

FIGURE 5-7: PORTD BLOCK DIAGRAM (IN I/O PORT MODE)



TABLE 5-9: PORTD FUNCTIONS

Name	Bit#	Buffer Type	Function
RD0/PSP0	bit0	ST/TTL ⁽¹⁾	Input/output port pin or parallel slave port bit0
RD1/PSP1	bit1	ST/TTL ⁽¹⁾	Input/output port pin or parallel slave port bit1
RD2/PSP2	bit2	ST/TTL ⁽¹⁾	Input/output port pin or parallel slave port bit2
RD3/PSP3	bit3	ST/TTL ⁽¹⁾	Input/output port pin or parallel slave port bit3
RD4/PSP4	bit4	ST/TTL ⁽¹⁾	Input/output port pin or parallel slave port bit4
RD5/PSP5	bit5	ST/TTL ⁽¹⁾	Input/output port pin or parallel slave port bit5
RD6/PSP6	bit6	ST/TTL ⁽¹⁾	Input/output port pin or parallel slave port bit6
RD7/PSP7	bit7	ST/TTL ⁽¹⁾	Input/output port pin or parallel slave port bit7

Legend: ST = Schmitt Trigger input, TTL = TTL input

Note 1: Buffer is a Schmitt Trigger when in I/O mode, and a TTL buffer when in Parallel Slave Port mode.

TABLE 5-10: SUMMARY OF REGISTERS ASSOCIATED WITH PORTD

Address	Name	Bit 7	Bit 6	Bit 5	Bit 4	Bit 3	Bit 2	Bit 1	Bit 0	Value on: POR, BOR	Value on all other resets
08h	PORTD	RD7	RD6	RD5	RD4	RD3	RD2	RD1	RD0	xxxx xxxx	uuuu uuuu
88h	TRISD	PORTD Data Direction Register								1111 1111	1111 1111
89h	TRISE	IBF	OBF	IBOV	PSPMODE	—	PORTE Data Direction Bits			0000 -111	0000 -111

Legend: x = unknown, u = unchanged, - = unimplemented locations read as '0'. Shaded cells are not used by PORTD.

PIC16C6X

5.5 PORTE and TRISE Register

Applicable Devices													
61	62	62A	R62	63	R63	64	64A	R64	65	65A	R65	66	67

PORTE has three pins, RE2/ \overline{CS} , RE1/ \overline{WR} , and RE0/ \overline{RD} which are individually configurable as inputs or outputs. These pins have Schmitt Trigger input buffers.

I/O PORTE becomes control inputs for the microprocessor port when bit PSPMODE (TRISE<4>) is set. In this mode, the user must make sure that the TRISE<2:0> bits are set (pins are configured as digital inputs). In this mode the input buffers are TTL.

Figure 5-9 shows the TRISE register, which controls the parallel slave port operation and also controls the direction of the PORTE pins.

FIGURE 5-8: PORTE BLOCK DIAGRAM (IN I/O PORT MODE)



FIGURE 5-9: TRISE REGISTER (ADDRESS 89h)

R-0	R-0	R/W-0	R/W-0	U-0	R/W-1	R/W-1	R/W-1		
IBF	OBF	IBOV	PSPMODE	—	bit2	bit1	bit0		
								bit7	bit0
<p>bit 7 : IBF: Input Buffer Full Status bit 1 = A word has been received and is waiting to be read by the CPU 0 = No word has been received</p> <p>bit 6 : OBF: Output Buffer Full Status bit 1 = The output buffer still holds a previously written word 0 = The output buffer has been read</p> <p>bit 5 : IBOV: Input Buffer Overflow Detect bit (in microprocessor mode) 1 = A write occurred when a previously input word has not been read (must be cleared in software) 0 = No overflow occurred</p> <p>bit 4 : PSPMODE: Parallel Slave Port Mode Select bit 1 = Parallel slave port mode 0 = General purpose I/O mode</p> <p>bit 3 : Unimplemented: Read as '0'</p> <p>PORTE Data Direction Bits</p> <p>bit 2 : Bit2: Direction Control bit for pin RE2/\overline{CS} 1 = Input 0 = Output</p> <p>bit 1 : Bit1: Direction Control bit for pin RE1/\overline{WR} 1 = Input 0 = Output</p> <p>bit 0 : Bit0: Direction Control bit for pin RE0/\overline{RD} 1 = Input 0 = Output</p>									

R = Readable bit
W = Writable bit
U = Unimplemented bit, read as '0'
- n = Value at POR reset

TABLE 5-11: PORTE FUNCTIONS

Name	Bit#	Buffer Type	Function
RE0/ \overline{RD}	bit0	ST/TTL ⁽¹⁾	Input/output port pin or Read control input in parallel slave port mode. \overline{RD} 1 = Not a read operation 0 = Read operation. The system reads the PORTD register (if chip selected)
RE1/ \overline{WR}	bit1	ST/TTL ⁽¹⁾	Input/output port pin or Write control input in parallel slave port mode. \overline{WR} 1 = Not a write operation 0 = Write operation. The system writes to the PORTD register (if chip selected)
RE2/ \overline{CS}	bit2	ST/TTL ⁽¹⁾	Input/output port pin or Chip select control input in parallel slave port mode. \overline{CS} 1 = Device is not selected 0 = Device is selected

Legend: ST = Schmitt Trigger input, TTL = TTL input

Note 1: Buffer is a Schmitt Trigger when in I/O mode, and a TTL buffer when in Parallel Slave Port (PSP) mode.

TABLE 5-12: SUMMARY OF REGISTERS ASSOCIATED WITH PORTE

Address	Name	Bit 7	Bit 6	Bit 5	Bit 4	Bit 3	Bit 2	Bit 1	Bit 0	Value on: POR, BOR	Value on all other resets
09h	PORTE	—	—	—	—	—	RE2	RE1	RE0	---- -xxx	---- -uuu
89h	TRISE	IBF	OBF	IBOV	PSPMODE	—	PORTE Data Direction Bits			0000 -111	0000 -111

Legend: x = unknown, u = unchanged, - = unimplemented locations read as '0'. Shaded cells not used by PORTE.

PIC16C6X

5.6 I/O Programming Considerations

Applicable Devices													
61	62	62A	R62	63	R63	64	64A	R64	65	65A	R65	66	67

5.6.1 BI-DIRECTIONAL I/O PORTS

Any instruction which writes, operates internally as a read followed by a write operation. The BCF and BSF instructions, for example, read the register into the CPU, execute the bit operation and write the result back to the register. Caution must be used when these instructions are applied to a port with both inputs and outputs defined. For example, a BSF operation on bit5 of PORTB will cause all eight bits of PORTB to be read into the CPU. Then the BSF operation takes place on bit5 and PORTB is written to the output latches. If another bit of PORTB is used as a bi-directional I/O pin (e.g., bit0) and it is defined as an input at this time, the input signal present on the pin itself would be read into the CPU and rewritten to the data latch of this particular pin, overwriting the previous content. As long as the pin stays in the input mode, no problem occurs. However, if bit0 is switched into output mode later on, the content of the data latch may now be unknown.

Reading the port register, reads the values of the port pins. Writing to the port register writes the value to the port latch. When using read-modify-write instructions (ex. BCF, BSF, etc.) on a port, the value of the port pins is read, the desired operation is done to this value, and this value is then written to the port latch.

Example 5-4 shows the effect of two sequential read-modify-write instructions on an I/O port.

EXAMPLE 5-4: READ-MODIFY-WRITE INSTRUCTIONS ON AN I/O PORT

```

;Initial PORT settings: PORTB<7:4> Inputs
;                          PORTB<3:0> Outputs
;PORTB<7:6> have external pull-ups and are
;not connected to other circuitry
;
;                          PORT latch  PORT pins
;                          -----
BCF PORTB, 7      ; 01pp pppp   11pp pppp
BCF PORTB, 6      ; 10pp pppp   11pp pppp
BSF STATUS, RP0  ;
BCF TRISB, 7      ; 10pp pppp   11pp pppp
BCF TRISB, 6      ; 10pp pppp   10pp pppp
;
;Note that the user may have expected the
;pin values to be 00pp pppp. The 2nd BCF
;caused RB7 to be latched as the pin value
;(high).

```

A pin actively outputting a Low or High should not be driven from external devices at the same time in order to change the level on this pin ("wired-or", "wired-and"). The resulting high output currents may damage the chip.

5.6.2 SUCCESSIVE OPERATIONS ON I/O PORTS

The actual write to an I/O port happens at the end of an instruction cycle, whereas for reading, the data must be valid at the beginning of the instruction cycle (Figure 5-10). Therefore, care must be exercised if a write followed by a read operation is carried out on the same I/O port. The sequence of instructions should be such to allow the pin voltage to stabilize (load dependent) before the next instruction which causes that file to be read into the CPU is executed. Otherwise, the previous state of that pin may be read into the CPU rather than the new state. When in doubt, it is better to separate these instructions with a NOP or another instruction not accessing this I/O port.

FIGURE 5-10: SUCCESSIVE I/O OPERATION



5.7 Parallel Slave Port

Applicable Devices													
61	62	62A	R62	63	R63	64	64A	R64	65	65A	R65	66	67

PORTD operates as an 8-bit wide parallel slave port (microprocessor port) when control bit PSPMODE (TRISE<4>) is set. In slave mode it is asynchronously readable and writable by the external world through \overline{RD} control input (RE0/ \overline{RD}) and \overline{WR} control input pin (RE1/ \overline{WR}).

It can directly interface to an 8-bit microprocessor data bus. The external microprocessor can read or write the PORTD latch as an 8-bit latch. Setting PSPMODE enables port pin RE0/ \overline{RD} to be the \overline{RD} input, RE1/ \overline{WR} to be the \overline{WR} input and RE2/ \overline{CS} to be the \overline{CS} (chip select) input. For this functionality, the corresponding data direction bits of the TRISE register (TRISE<2:0>) must be configured as inputs (set).

There are actually two 8-bit latches, one for data-out (from the PIC16/17) and one for data input. The user writes 8-bit data to PORTD data latch and reads data from the port pin latch (note that they have the same address). In this mode, the TRISD register is ignored since the microprocessor is controlling the direction of data flow.

A write to the PSP occurs when both the \overline{CS} and \overline{WR} lines are first detected low. When either the \overline{CS} or \overline{WR} lines become high (level triggered), then the Input Buffer Full status flag bit IBF (TRISE<7>) is set on the Q4 clock cycle, following the next Q2 cycle, to signal the write is complete (Figure 5-12). The interrupt flag bit PSPIF (PIR1<7>) is also set on the same Q4 clock cycle. IBF can only be cleared by reading the PORTD input latch. The input Buffer Overflow status flag bit IBOV (TRISE<5>) is set if a second write to the Parallel Slave Port is attempted when the previous byte has not been read out of the buffer.

A read from the PSP occurs when both the \overline{CS} and \overline{RD} lines are first detected low. The Output Buffer Full status flag bit OBF (TRISE<6>) is cleared immediately (Figure 5-13) indicating that the PORTD latch is waiting to be read by the external bus. When either the \overline{CS} or \overline{RD} pin becomes high (level triggered), the interrupt flag bit PSPIF is set on the Q4 clock cycle, following the next Q2 cycle, indicating that the read is complete. OBF remains low until data is written to PORTD by the user firmware.

When not in Parallel Slave Port mode, the IBF and OBF bits are held clear. However, if flag bit IBOV was previously set, it must be cleared in firmware.

An interrupt is generated and latched into flag bit PSPIF when a read or write operation is completed. PSPIF must be cleared by the user in firmware and the interrupt can be disabled by clearing the interrupt enable bit PSPIE (PIE1<7>).

FIGURE 5-11: PORTD AND PORTE AS A PARALLEL SLAVE PORT



PIC16C6X

FIGURE 5-12: PARALLEL SLAVE PORT WRITE WAVEFORMS



FIGURE 5-13: PARALLEL SLAVE PORT READ WAVEFORMS



TABLE 5-13: REGISTERS ASSOCIATED WITH PARALLEL SLAVE PORT

Address	Name	Bit 7	Bit 6	Bit 5	Bit 4	Bit 3	Bit 2	Bit 1	Bit 0	Value on: POR, BOR	Value on all other resets
08h	PORTD	PSP7	PSP6	PSP5	PSP4	PSP3	PSP2	PSP1	PSP0	xxxxx xxxxx	uuuu uuuu
09h	PORTE	—	—	—	—	—	RE2	RE1	RE0	---- -xxx	---- -uuu
89h	TRISE	IBF	OBF	IBOV	PSPMODE	—	PORTE Data Direction Bits			0000 -111	0000 -111
0Ch	PIR1	PSPIF	(1)	RCIF(2)	TXIF(2)	SSPIF	CCP1IF	TMR2IF	TRM1IF	0000 0000	0000 0000
8Ch	PIE1	PSPIE	(1)	RCIE(2)	TXIE(2)	SSPIE	CCP1IE	TMR2IE	TMR1IE	0000 0000	0000 0000

Legend: x = unknown, u = unchanged, - = unimplemented locations read as '0'. Shaded cells are not used by the PSP.

Note 1: These bits are reserved, always maintain these bits clear.

Note 2: These bits are implemented on the PIC16C65/65A/R65/67 only.

6.0 OVERVIEW OF TIMER MODULES

Applicable Devices													
61	62	62A	R62	63	R63	64	64A	R64	65	65A	R65	66	67

All PIC16C6X devices have three timer modules except for the PIC16C61, which has one timer module. Each module can generate an interrupt to indicate that an event has occurred (i.e., timer overflow). Each of these modules are detailed in the following sections. The timer modules are:

- Timer0 module (Section 7.0)
- Timer1 module (Section 8.0)
- Timer2 module (Section 9.0)

6.1 Timer0 Overview

Applicable Devices													
61	62	62A	R62	63	R63	64	64A	R64	65	65A	R65	66	67

The Timer0 module is a simple 8-bit overflow counter. The clock source can be either the internal system clock ($F_{osc}/4$) or an external clock. When the clock source is an external clock, the Timer0 module can be selected to increment on either the rising or falling edge.

The Timer0 module also has a programmable prescaler option. This prescaler can be assigned to either the Timer0 module or the Watchdog Timer. Bit PSA (OPTION<3>) assigns the prescaler, and bits PS2:PS0 (OPTION<2:0>) determine the prescaler value. TMR0 can increment at the following rates: 1:1 when the prescaler is assigned to Watchdog Timer, 1:2, 1:4, 1:8, 1:16, 1:32, 1:64, 1:128, and 1:256.

Synchronization of the external clock occurs after the prescaler. When the prescaler is used, the external clock frequency may be higher than the device's frequency. The maximum frequency is 50 MHz, given the high and low time requirements of the clock.

6.2 Timer1 Overview

Applicable Devices													
61	62	62A	R62	63	R63	64	64A	R64	65	65A	R65	66	67

Timer1 is a 16-bit timer/counter. The clock source can be either the internal system clock ($F_{osc}/4$), an external clock, or an external crystal. Timer1 can operate as either a timer or a counter. When operating as a counter (external clock source), the counter can either operate synchronized to the device or asynchronously to the device. Asynchronous operation allows Timer1 to operate during sleep, which is useful for applications that require a real-time clock as well as the power savings of SLEEP mode.

Timer1 also has a prescaler option which allows TMR1 to increment at the following rates: 1:1, 1:2, 1:4, and 1:8. TMR1 can be used in conjunction with the Capture/Compare/PWM module. When used with a CCP module, Timer1 is the time-base for 16-bit capture or 16-bit compare and must be synchronized to the device.

6.3 Timer2 Overview

Applicable Devices													
61	62	62A	R62	63	R63	64	64A	R64	65	65A	R65	66	67

Timer2 is an 8-bit timer with a programmable prescaler and a programmable postscaler, as well as an 8-bit Period Register (PR2). Timer2 can be used with the CCP module (in PWM mode) as well as the Baud Rate Generator for the Synchronous Serial Port (SSP). The prescaler option allows Timer2 to increment at the following rates: 1:1, 1:4, and 1:16.

The postscaler allows TMR2 register to match the period register (PR2) a programmable number of times before generating an interrupt. The postscaler can be programmed from 1:1 to 1:16 (inclusive).

6.4 CCP Overview

Applicable Devices													
61	62	62A	R62	63	R63	64	64A	R64	65	65A	R65	66	67

The CCP module(s) can operate in one of three modes: 16-bit capture, 16-bit compare, or up to 10-bit Pulse Width Modulation (PWM).

Capture mode captures the 16-bit value of TMR1 into the CCPRxH:CCPRxL register pair. The capture event can be programmed for either the falling edge, rising edge, fourth rising edge, or sixteenth rising edge of the CCPx pin.

Compare mode compares the TMR1H:TMR1L register pair to the CCPRxH:CCPRxL register pair. When a match occurs, an interrupt can be generated and the output pin CCPx can be forced to a given state (High or Low) and Timer1 can be reset. This depends on control bits CCPxM3:CCPxM0.

PWM mode compares the TMR2 register to a 10-bit duty cycle register (CCPRxH:CCPRxL<5:4>) as well as to an 8-bit period register (PR2). When the TMR2 register = Duty Cycle register, the CCPx pin will be forced low. When TMR2 = PR2, TMR2 is cleared to 00h, an interrupt can be generated, and the CCPx pin (if an output) will be forced high.

PIC16C6X

NOTES:

7.0 TIMER0 MODULE

Applicable Devices													
61	62	62A	R62	63	R63	64	64A	R64	65	65A	R65	66	67

The Timer0 module has the following features:

- 8-bit timer/counter register, TMR0
 - Read and write capability
 - Interrupt on overflow from FFh to 00h
- 8-bit software programmable prescaler
- Internal or external clock select
 - Edge select for external clock

Figure 7-1 is a simplified block diagram of the Timer0 module.

Timer mode is selected by clearing bit T0CS (OPTION<5>). In timer mode, the Timer0 module will increment every instruction cycle (without prescaler). If TMR0 register is written, the increment is inhibited for the following two instruction cycles (Figure 7-2 and Figure 7-3). The user can work around this by writing an adjusted value to the TMR0 register.

Counter mode is selected by setting bit T0CS. In this mode, Timer0 will increment either on every rising or falling edge of pin RA4/T0CKI. The incrementing edge is determined by the source edge select bit T0SE

(OPTION<4>). Clearing bit T0SE selects the rising edge. Restrictions on the external clock input are discussed in detail in Section 7.2.

The prescaler is mutually exclusively shared between the Timer0 module and the Watchdog Timer. The prescaler assignment is controlled in software by control bit PSA (OPTION<3>). Clearing bit PSA will assign the prescaler to the Timer0 module. The prescaler is not readable or writable. When the prescaler is assigned to the Timer0 module, prescale values of 1:2, 1:4, ..., 1:256 are selectable. Section 7.3 details the operation of the prescaler.

7.1 TMR0 Interrupt

Applicable Devices													
61	62	62A	R62	63	R63	64	64A	R64	65	65A	R65	66	67

The TMR0 interrupt is generated when the register (TMR0) overflows from FFh to 00h. This overflow sets interrupt flag bit T0IF (INTCON<2>). The interrupt can be masked by clearing enable bit T0IE (INTCON<5>). Flag bit T0IF must be cleared in software by the Timer0 interrupt service routine before re-enabling this interrupt. The TMR0 interrupt cannot wake the processor from SLEEP since the timer is shut off during SLEEP. Figure 7-4 displays the Timer0 interrupt timing.

FIGURE 7-1: TIMER0 BLOCK DIAGRAM



FIGURE 7-2: TIMER0 TIMING: INTERNAL CLOCK/NO PRESCALER



PIC16C6X

FIGURE 7-3: TIMER0 TIMING: INTERNAL CLOCK/PRESCALE 1:2



FIGURE 7-4: TMR0 INTERRUPT TIMING



7.2 Using Timer0 with External Clock

Applicable Devices

61	62	62A	R62	63	R63	64	64A	R64	65	65A	R65	66	67
----	----	-----	-----	----	-----	----	-----	-----	----	-----	-----	----	----

When an external clock input is used for Timer0, it must meet certain requirements. The requirements ensure the external clock can be synchronized with the internal phase clock (Tosc). Also, there is a delay in the actual incrementing of Timer0 after synchronization.

7.2.1 EXTERNAL CLOCK SYNCHRONIZATION

When no prescaler is used, the external clock input is the same as the prescaler output. The synchronization of T0CKI with the internal phase clocks is accomplished by sampling the prescaler output on the Q2 and Q4 cycles of the internal phase clocks (Figure 7-5). Therefore, it is necessary for T0CKI to be high for at least 2Tosc (and a small RC delay of 20 ns) and low for at least 2Tosc (and a small RC delay of 20 ns). Refer to the electrical specification of the desired device.

When a prescaler is used, the external clock input is divided by the asynchronous ripple-counter type prescaler so that the prescaler output is symmetrical. For the external clock to meet the sampling requirement, the ripple-counter must be taken into account. Therefore, it is necessary for T0CKI to have a period of at least 4Tosc (and a small RC delay of 40 ns) divided by the prescaler value. The only requirement on T0CKI high and low time is that they do not violate the minimum pulse width requirement of 10 ns. Refer to parameters 40, 41 and 42 in the electrical specification of the desired device.

7.2.2 TIMER0 INCREMENT DELAY

Since the prescaler output is synchronized with the internal clocks, there is a small delay from the time the external clock edge occurs to the time the Timer0 module is actually incremented. Figure 7-5 shows the delay from the external clock edge to the timer incrementing.

FIGURE 7-5: TIMER0 TIMING WITH EXTERNAL CLOCK



PIC16C6X

7.3 Prescaler

Applicable Devices													
61	62	62A	R62	63	R63	64	64A	R64	65	65A	R65	66	67

An 8-bit counter is available as a prescaler for the Timer0 module or as a postscaler for the Watchdog Timer (WDT), respectively (Figure 7-6). For simplicity, this counter is being referred to as “prescaler” throughout this data sheet. Note that the prescaler may be used by either the Timer0 module or the Watchdog Timer, but not both. Thus, a prescaler assignment for the Timer0 module means that there is no prescaler for the Watchdog Timer, and vice-versa.

The PSA and PS2:PS0 bits (OPTION<3:0>) determine the prescaler assignment and prescale ratio.

When assigned to the Timer0 module, all instructions writing to the TMR0 register (e.g. `CLRF TMR0`, `MOVWF TMR0`, `BSF TMR0, bitx`) will clear the prescaler count. When assigned to the Watchdog Timer, a `CLRWDT` instruction will clear the Watchdog Timer and the prescaler count. The prescaler is not readable or writable.

Note: Writing to TMR0 when the prescaler is assigned to Timer0 will clear the prescaler count, but will not change the prescaler assignment.

FIGURE 7-6: BLOCK DIAGRAM OF THE TIMER0/WDT PRESCALER



7.3.1 SWITCHING PRESCALER ASSIGNMENT

The prescaler assignment is fully under software control, i.e., it can be changed “on the fly” during program execution.

Note: To avoid an unintended device RESET, the following instruction sequence (shown in Example 7-1) must be executed when changing the prescaler assignment from Timer0 to the WDT. This precaution must be followed even if the WDT is disabled.

EXAMPLE 7-1: CHANGING PRESCALER (TIMER0→WDT)

```

1) BSF    STATUS, RP0    ;Bank 1
Lines 2 and 3 do NOT have to 2) MOVLW  b'xx0x0xxx'    ;Select clock source and prescale value of
be included if the final desired 3) MOVWF  OPTION_REG    ;other than 1:1
prescale value is other than 1:1. 4) BCF    STATUS, RP0    ;Bank 0
If 1:1 is final desired value, then 5) CLRWF TMR0          ;Clear TMR0 and prescaler
a temporary prescale value is 6) BSF    STATUS, RP1    ;Bank 1
set in lines 2 and 3 and the final 7) MOVLW  b'xxxx1xxx'    ;Select WDT, do not change prescale value
prescale value will be set in lines 8) MOVWF  OPTION_REG    ;
10 and 11.                      9) CLRWDT                ;Clears WDT and prescaler
                                10) MOVLW  b'xxxx1xxx'    ;Select new prescale value and WDT
                                11) MOVWF  OPTION_REG    ;
                                12) BCF    STATUS, RP0    ;Bank 0

```

To change prescaler from the WDT to the Timer0 module, use the sequence shown in Example 7-2.

EXAMPLE 7-2: CHANGING PRESCALER (WDT→TIMER0)

```

CLRWDT                ;Clear WDT and prescaler
BSF    STATUS, RP0    ;Bank 1
MOVLW  b'xxxx0xxx'    ;Select TMR0, new prescale value and clock source
MOVWF  OPTION_REG    ;
BCF    STATUS, RP0    ;Bank 0

```

TABLE 7-1: REGISTERS ASSOCIATED WITH TIMER0

Address	Name	Bit 7	Bit 6	Bit 5	Bit 4	Bit 3	Bit 2	Bit 1	Bit 0	Value on: POR, BOR	Value on all other resets
01h, 101h	TMR0	Timer0 module's register								xxxx xxxx	uuuu uuuu
0Bh,8Bh, 10Bh,18Bh	INTCON	GIE	PEIE ⁽¹⁾	TOIE	INTE	RBIE	TOIF	INTF	RBIF	0000 000x	0000 000u
81h, 181h	OPTION	RBPU	INTEDG	T0CS	T0SE	PSA	PS2	PS1	PS0	1111 1111	1111 1111
85h	TRISA	—	—	PORTA Data Direction Register ⁽¹⁾						--11 1111	--11 1111

Legend: x = unknown, u = unchanged, - = unimplemented locations read as '0'. Shaded cells are not used by Timer0.

Note 1: TRISA<5> and bit PEIE are not implemented on the PIC16C61, read as '0'.

PIC16C6X

NOTES:

8.0 TIMER1 MODULE

Applicable Devices													
61	62	62A	R62	63	R63	64	64A	R64	65	65A	R65	66	67

Timer1 is a 16-bit timer/counter consisting of two 8-bit registers (TMR1H and TMR1L) which are readable and writable. Register TMR1 (TMR1H:TMR1L) increments from 0000h to FFFFh and rolls over to 0000h. The TMR1 Interrupt, if enabled, is generated on overflow which is latched in interrupt flag bit TMR1IF (PIR1<0>). This interrupt can be enabled/disabled by setting/clearing the TMR1 interrupt enable bit TMR1IE (PIE1<0>).

Timer1 can operate in one of two modes:

- As a timer
- As a counter

The operating mode is determined by clock select bit, TMR1CS (T1CON<1>) (Figure 8-2).

In timer mode, Timer1 increments every instruction cycle. In counter mode, it increments on every rising edge of the external clock input.

Timer1 can be enabled/disabled by setting/clearing control bit TMR1ON (T1CON<0>).

Timer1 also has an internal “reset input”. This reset can be generated by CCP1 or CCP2 (Capture/Compare/PWM) module. See Section 10.0 for details. Figure 8-1 shows the Timer1 control register.

For the PIC16C62A/R62/63/R63/64A/R64/65A/R65/R66/67, when the Timer1 oscillator is enabled (T1OSCEN is set), the RC1 and RC0 pins become inputs. That is, the TRISC<1:0> value is ignored.

For the PIC16C62/64/65, when the Timer1 oscillator is enabled (T1OSCEN is set), RC1 pin becomes an input, however the RC0 pin will have to be configured as an input by setting the TRISC<0> bit.

The Timer1 module also has a software programmable prescaler.

FIGURE 8-1: T1CON: TIMER1 CONTROL REGISTER (ADDRESS 10h)

U-0	U-0	R/W-0	R/W-0	R/W-0	R/W-0	R/W-0	R/W-0	
—	—	T1CKPS1	T1CKPS0	T1OSCEN	T1SYNC	TMR1CS	TMR1ON	
bit7								bit0

R = Readable bit
W = Writable bit
U = Unimplemented bit, read as '0'
-n = Value at POR reset

bit 7-6: **Unimplemented:** Read as '0'

bit 5-4: **T1CKPS1:T1CKPS0:** Timer1 Input Clock Prescale Select bits
11 = 1:8 Prescale value
10 = 1:4 Prescale value
01 = 1:2 Prescale value
00 = 1:1 Prescale value

bit 3: **T1OSCEN:** Timer1 Oscillator Enable Control bit
1 = Oscillator is enabled
0 = Oscillator is shut off
Note: The oscillator inverter and feedback resistor are turned off to eliminate power drain.

bit 2: **T1SYNC:** Timer1 External Clock Input Synchronization Control bit
TMR1CS = 1
1 = Do not synchronize external clock input
0 = Synchronize external clock input
TMR1CS = 0
This bit is ignored. Timer1 uses the internal clock when TMR1CS = 0.

bit 1: **TMR1CS:** Timer1 Clock Source Select bit
1 = External clock from T1OSI (on the rising edge) (See pinouts for pin with T1OSI function)
0 = Internal clock (Fosc/4)

bit 0: **TMR1ON:** Timer1 On bit
1 = Enables Timer1
0 = Stops Timer1

PIC16C6X

8.1 Timer1 Operation in Timer Mode

Applicable Devices													
61	62	62A	R62	63	R63	64	64A	R64	65	65A	R65	66	67

Timer mode is selected by clearing bit TMR1CS (T1CON<1>). In this mode, the input clock to the timer is $F_{osc}/4$. The synchronize control bit T1SYNC (T1CON<2>) has no effect since the internal clock is always in sync.

8.2 Timer1 Operation in Synchronized Counter Mode

Applicable Devices													
61	62	62A	R62	63	R63	64	64A	R64	65	65A	R65	66	67

Counter mode is selected by setting bit TMR1CS. In this mode the timer increments on every rising edge of clock input on T1OSI when enable bit T1OSCEN is set or pin with T1CKI when bit T1OSCEN is cleared.

Note: The T1OSI function is multiplexed to different pins, depending on the device. See the pinout descriptions to see which pin has the T1OSI function.

If T1SYNC is cleared, then the external clock input is synchronized with internal phase clocks. The synchronization is done after the prescaler stage. The prescaler stage is an asynchronous ripple counter.

In this configuration, during SLEEP mode, Timer1 will not increment even if an external clock is present, since the synchronization circuit is shut off. The prescaler, however, will continue to increment.

8.2.1 EXTERNAL CLOCK INPUT TIMING FOR SYNCHRONIZED COUNTER MODE

When an external clock input is used for Timer1 in synchronized counter mode, it must meet certain requirements. The external clock requirement is due to internal phase clock (T_{osc}) synchronization. Also, there is a delay in the actual incrementing of TMR1 after synchronization.

When the prescaler is 1:1, the external clock input is the same as the prescaler output. The synchronization of T1CKI with the internal phase clocks is accomplished by sampling the prescaler output on the Q2 and Q4 cycles of the internal phase clocks. Therefore, it is necessary for T1CKI to be high for at least $2T_{osc}$ (and a small RC delay of 20 ns) and low for at least $2T_{osc}$ (and a small RC delay of 20 ns). Refer to appropriate electrical specification section, parameters 45, 46, and 47.

When a prescaler other than 1:1 is used, the external clock input is divided by the asynchronous ripple-counter type prescaler so that the prescaler output is symmetrical. In order for the external clock to meet the sampling requirement, the ripple counter must be taken into account. Therefore, it is necessary for T1CKI to have a period of at least $4T_{osc}$ (and a small RC delay of 40 ns) divided by the prescaler value. The only requirement on T1CKI high and low time is that they do not violate the minimum pulse width requirements of 10 ns). Refer to applicable electrical specification section, parameters 40, 42, 45, 46, and 47.

FIGURE 8-2: TIMER1 BLOCK DIAGRAM



8.3 Timer1 Operation in Asynchronous Counter Mode

Applicable Devices													
61	62	62A	R62	63	R63	64	64A	R64	65	65A	R65	66	67

If control bit $\overline{T1SYNC}$ (T1CON<2>) is set, the external clock input is not synchronized. The timer continues to increment asynchronous to the internal phase clocks. The timer will continue to run during SLEEP and generate an interrupt on overflow which will wake the processor. However, special precautions in software are needed to read-from or write-to the Timer1 register pair, TMR1L and TMR1H (Section 8.3.2).

In asynchronous counter mode, Timer1 cannot be used as a time-base for capture or compare operations.

8.3.1 EXTERNAL CLOCK INPUT TIMING WITH UNSYNCHRONIZED CLOCK

If control bit $\overline{T1SYNC}$ is set, the timer will increment completely asynchronously. The input clock must meet certain minimum high time and low time requirements, as specified in timing parameters (45 - 47).

8.3.2 READING AND WRITING TMR1 IN ASYNCHRONOUS COUNTER MODE

Reading TMR1H or TMR1L, while the timer is running from an external asynchronous clock, will ensure a valid read (taken care of in hardware). However, the user should keep in mind that reading the 16-bit timer in two 8-bit values itself poses certain problems since the timer may overflow between the reads.

For writes, it is recommended that the user simply stop the timer and write the desired values. A write contention may occur by writing to the timer registers while the register is incrementing. This may produce an unpredictable value in the timer register.

Reading the 16-bit value requires some care. Example 8-1 is an example routine to read the 16-bit timer value. This is useful if the timer cannot be stopped.

EXAMPLE 8-1: READING A 16-BIT FREE-RUNNING TIMER

```

; All Interrupts are disabled
MOVF   TMR1H, W      ;Read high byte
MOVWF  TMPH          ;
MOVF   TMR1L, W      ;Read low byte
MOVWF  TMPL          ;
MOVF   TMR1H, W      ;Read high byte
SUBWF  TMPH, W       ;Sub 1st read
                          ;with 2nd read

      BTFSC STATUS,Z  ;is result = 0
      GOTO  CONTINUE  ;Good 16-bit read
; TMR1L may have rolled over between the read
; of the high and low bytes. Reading the high
; and low bytes now will read a good value.
MOVF   TMR1H, W      ;Read high byte
MOVWF  TMPH          ;
MOVF   TMR1L, W      ;Read low byte
MOVWF  TMPL          ;
; Re-enable Interrupt (if required)
CONTINUE          ;Continue with
                  ;your code
    
```

8.4 Timer1 Oscillator

Applicable Devices													
61	62	62A	R62	63	R63	64	64A	R64	65	65A	R65	66	67

A crystal oscillator circuit is built in-between pins T1OS1 (input) and T1OSO (amplifier output). It is enabled by setting control bit T1OSCEN (T1CON<3>). The oscillator is a low power oscillator rated up to 200 kHz. It will continue to run during SLEEP. It is primarily intended for a 32 kHz crystal. Table 8-1 shows the capacitor selection for the Timer1 oscillator.

The Timer1 oscillator is identical to the LP oscillator. The user must allow a software time delay to ensure proper oscillator start-up.

TABLE 8-1: CAPACITOR SELECTION FOR THE TIMER1 OSCILLATOR

Osc Type	Freq	C1	C2
LP	32 kHz	33 pF	33 pF
	100 kHz	15 pF	15 pF
	200 kHz	15 pF	15 pF
These values are for design guidance only.			
Crystals Tested:			
32.768 kHz	Epson C-001R32.768K-A	± 20 PPM	
100 kHz	Epson C-2 100.00 KC-P	± 20 PPM	
200 kHz	STD XTL 200.000 kHz	± 20 PPM	
<p>Note 1: Higher capacitance increases the stability of oscillator but also increases the start-up time.</p> <p>2: Since each resonator/crystal has its own characteristics, the user should consult the resonator/crystal manufacturer for appropriate values of external components.</p>			

PIC16C6X

8.5 Resetting Timer1 using a CCP Trigger Output

Applicable Devices													
61	62	62A	R62	63	R63	64	64A	R64	65	65A	R65	66	67

CCP2 is implemented on the PIC16C63/R63/65/65A/R65/66/67 only.

If CCP1 or CCP2 module is configured in Compare mode to generate a “special event trigger” (CCPxM3:CCPxM0 = 1011), this signal will reset Timer1.

Note: The “special event trigger” from the CCP1 and CCP2 modules will not set interrupt flag bit TMR1IF(PIR1<0>).

Timer1 must be configured for either timer or synchronized counter mode to take advantage of this feature. If the Timer1 is running in asynchronous counter mode, this reset operation may not work.

In the event that a write to Timer1 coincides with a special event trigger from CCP1 or CCP2, the write will take precedence.

In this mode of operation, the CCPxH:CCPxL registers pair effectively becomes the period register for the Timer1 module.

8.6 Resetting of TMR1 Register Pair (TMR1H:TMR1L)

Applicable Devices													
61	62	62A	R62	63	R63	64	64A	R64	65	65A	R65	66	67

The TMR1H and TMR1L registers are not reset to 00h on a POR or any other reset except by the CCP1 or CCP2 special event trigger.

The T1CON register is reset to 00h on a Power-on Reset or a Brown-out Reset, which shuts off the timer and leaves a 1:1 prescaler. In all other resets, the register is unaffected.

8.7 Timer1 Prescaler

Applicable Devices													
61	62	62A	R62	63	R63	64	64A	R64	65	65A	R65	66	67

The prescaler counter is cleared on writes to the TMR1H or TMR1L registers.

TABLE 8-2: REGISTERS ASSOCIATED WITH TIMER1 AS A TIMER/COUNTER

Address	Name	Bit 7	Bit 6	Bit 5	Bit 4	Bit 3	Bit 2	Bit 1	Bit 0	Value on: POR, BOR	Value on all other resets
0Bh,8Bh 10Bh,18Bh	INTCON	GIE	PEIE	T0IE	INTE	RBIE	T0IF	INTF	RBIF	0000 000x	0000 000u
0Ch	PIR1	PSPIF ⁽²⁾	⁽³⁾	RCIF ⁽¹⁾	TXIF ⁽¹⁾	SSPIF	CCP1IF	TMR2IF	TMR1IF	0000 0000	0000 0000
8Ch	PIE1	PSPIE ⁽²⁾	⁽³⁾	RCIE ⁽¹⁾	TXIE ⁽¹⁾	SSPIE	CCP1IE	TMR2IE	TMR1IE	0000 0000	0000 0000
0Eh	TMR1L	Holding register for the Least Significant Byte of the 16-bit TMR1 register								xxxx xxxx	uuuu uuuu
0Fh	TMR1H	Holding register for the Most Significant Byte of the 16-bit TMR1 register								xxxx xxxx	uuuu uuuu
10h	T1CON	—	—	T1CKPS1	T1CKPS0	T1OSCEN	T1SYNC	TMR1CS	TMR1ON	--00 0000	--uu uuuu

Legend: x = unknown, u = unchanged, - = unimplemented read as '0'. Shaded cells are not used by the Timer1 module.

Note 1: The USART is implemented on the PIC16C63/R63/65/65A/R65/66/67 only.

Note 2: Bits PSPIE and PSPIF are reserved on the PIC16C62/62A/R62/63/R63/66, always maintain these bits clear.

Note 3: PIR1<6> and PIE1<6> are reserved, always maintain these bits clear.

9.0 TIMER2 MODULE

Applicable Devices													
61	62	62A	R62	63	R63	64	64A	R64	65	65A	R65	66	67

Timer2 is an 8-bit timer with a prescaler and a postscaler. It is especially suitable as PWM time-base for PWM mode of CCP module(s). TMR2 is a readable and writable register, and is cleared on any device reset.

The input clock (FOSC/4) has a prescale option of 1:1, 1:4 or 1:16, selected by control bits T2CKPS1:T2CKPS0 (T2CON<1:0>).

The Timer2 module has an 8-bit period register, PR2. Timer2 increments from 00h until it matches PR2 and then resets to 00h on the next increment cycle. PR2 is a readable and writable register. The PR2 register is initialized to FFh upon reset.

The match output of the TMR2 register goes through a 4-bit postscaler (which gives a 1:1 to 1:16 scaling, inclusive) to generate a TMR2 interrupt (latched in flag bit TMR2IF (PIR1<1>)).

The Timer2 module can be shut off by clearing control bit TMR2ON (T2CON<2>) to minimize power consumption.

Figure 9-2 shows the Timer2 control register. T2CON is cleared upon reset which initializes Timer2 as shut off with the prescaler and postscaler at a 1:1 value.

9.1 Timer2 Prescaler and Postscaler

Applicable Devices													
61	62	62A	R62	63	R63	64	64A	R64	65	65A	R65	66	67

The prescaler and postscaler counters are cleared when any of the following occurs:

- a write to the TMR2 register
- a write to the T2CON register
- any device reset (POR, BOR, MCLR Reset, or WDT Reset).

TMR2 is not cleared when T2CON is written.

9.2 Output of TMR2

Applicable Devices													
61	62	62A	R62	63	R63	64	64A	R64	65	65A	R65	66	67

The output of TMR2 (before the postscaler) is fed to the Synchronous Serial Port module which optionally uses it to generate shift clock.

FIGURE 9-1: TIMER2 BLOCK DIAGRAM



FIGURE 9-2: T2CON: TIMER2 CONTROL REGISTER (ADDRESS 12h)

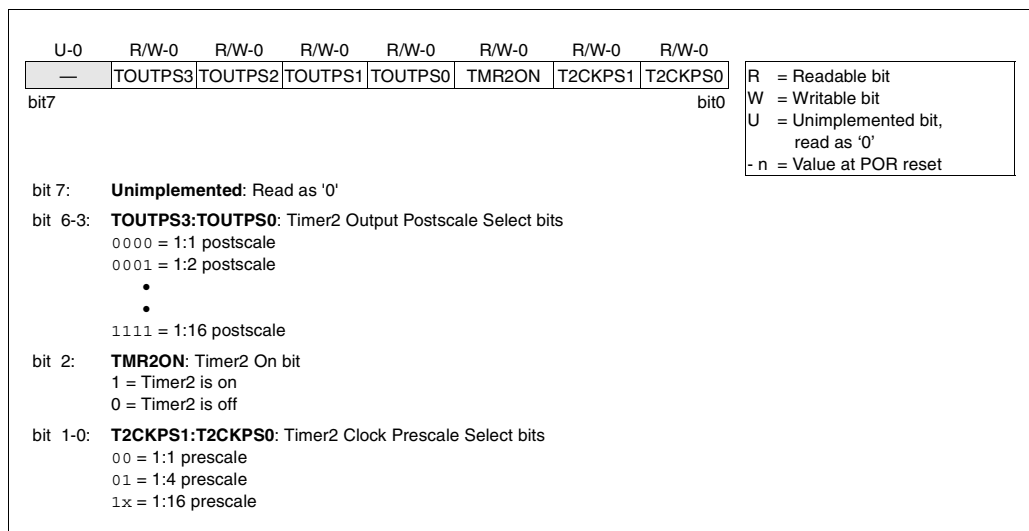

PIC16C6X

TABLE 9-1: REGISTERS ASSOCIATED WITH TIMER2 AS A TIMER/COUNTER

Address	Name	Bit 7	Bit 6	Bit 5	Bit 4	Bit 3	Bit 2	Bit 1	Bit 0	Value on: POR, BOR	Value on all other resets
0Bh,8Bh 10Bh,18Bh	INTCON	GIE	PEIE	T0IE	INTE	RBIE	T0IF	INTF	RBIF	0000 000x	0000 000u
0Ch	PIR1	PSPIF ⁽²⁾	⁽³⁾	RCIF ⁽¹⁾	TXIF ⁽¹⁾	SSPIF	CCP1IF	TMR2IF	TMR1IF	0000 0000	0000 0000
8Ch	PIE1	PSPIE ⁽²⁾	⁽³⁾	RCIE ⁽¹⁾	TXIE ⁽¹⁾	SSPIE	CCP1IE	TMR2IE	TMR1IE	0000 0000	0000 0000
11h	TMR2	Timer2 module's register								0000 0000	0000 0000
12h	T2CON	—	TOUTPS3	TOUTPS2	TOUTPS1	TOUTPS0	TMR2ON	T2CKPS1	T2CKPS0	-000 0000	-000 0000
92h	PR2	Timer2 Period register								1111 1111	1111 1111

Legend: x = unknown, u = unchanged, - = unimplemented locations read as '0'. Shaded cells are not used by Timer2.

Note 1: The USART is implemented on the PIC16C63/R63/65/65A/R65/66/67 only.

2: Bits PSPIE and PSPIF are reserved on the PIC16C62/62A/R62/63/R63/66, always maintain these bits clear.

3: PIR1<6> and PIE1<6> are reserved, always maintain these bits clear.

10.0 CAPTURE/COMPARE/PWM (CCP) MODULE(S)

Applicable Devices														
61	62	62A	R62	63	R63	64	64A	R64	65	65A	R65	66	67	CCP1
61	62	62A	R62	63	R63	64	64A	R64	65	65A	R65	66	67	CCP2

Each CCP (Capture/Compare/PWM) module contains a 16-bit register which can operate as a 16-bit capture register, as a 16-bit compare register, or as a PWM master/slave duty cycle register. Both the CCP1 and CCP2 modules are identical in operation, with the exception of the operation of the special event trigger. Table 10-1 and Table 10-2 show the resources and interactions of the CCP modules(s). In the following sections, the operation of a CCP module is described with respect to CCP1. CCP2 operates the same as CCP1, except where noted.

CCP1 module:

Capture/Compare/PWM Register1 (CCPR1) is comprised of two 8-bit registers: CCPR1L (low byte) and CCPR1H (high byte). The CCP1CON register controls the operation of CCP1. All are readable and writable.

CCP2 module:

Capture/Compare/PWM Register2 (CCPR2) is comprised of two 8-bit registers: CCPR2L (low byte) and CCPR2H (high byte). The CCP2CON register controls the operation of CCP2. All are readable and writable.

For use of the CCP modules, refer to the *Embedded Control Handbook*, "Using the CCP Modules" (AN594).

TABLE 10-1: CCP MODE - TIMER RESOURCE

CCP Mode	Timer Resource
Capture	Timer1
Compare	Timer1
PWM	Timer2

TABLE 10-2: INTERACTION OF TWO CCP MODULES

CCPx Mode	CCPy Mode	Interaction
Capture	Capture	Same TMR1 time-base.
Capture	Compare	The compare should be configured for the special event trigger, which clears TMR1.
Compare	Compare	The compare(s) should be configured for the special event trigger, which clears TMR1.
PWM	PWM	The PWMs will have the same frequency, and update rate (TMR2 interrupt).
PWM	Capture	None
PWM	Compare	None

PIC16C6X

FIGURE 10-1: CCP1CON REGISTER (ADDRESS 17h) / CCP2CON REGISTER (ADDRESS 1Dh)



10.1 Capture Mode

Applicable Devices													
61	62	62A	R62	63	R63	64	64A	R64	65	65A	R65	66	67

In Capture mode, CCPR1H:CCPR1L captures the 16-bit value of the TMR1 register when an event occurs on pin RC2/CCP1 (Figure 10-2). An event is defined as:

- Every falling edge
- Every rising edge
- Every 4th rising edge
- Every 16th rising edge

An event is selected by control bits CCP1M3:CCP1M0 (CCP1CON<3:0>). When a capture is made, the interrupt request flag bit CCP1IF (PIR1<2>) is set. It must be cleared in software. If another capture occurs before the value in register CCPR1 is read, the old captured value will be lost.

10.1.1 CCP PIN CONFIGURATION

In Capture mode, the RC2/CCP1 pin should be configured as an input by setting the TRISC<2> bit.

Note: If the RC2/CCP1 pin is configured as an output, a write to PORTC can cause a capture condition.

FIGURE 10-2: CAPTURE MODE OPERATION BLOCK DIAGRAM



10.1.2 TIMER1 MODE SELECTION

Timer1 must be running in Timer mode or Synchronized Counter mode for the CCP module to use the capture feature. In Asynchronous Counter mode, the capture operation may not work consistently.

10.1.3 SOFTWARE INTERRUPT

When the Capture event is changed, a false capture interrupt may be generated. The user should clear enable bit CCP1IE (PIE1<2>) to avoid false interrupts and should clear flag bit CCP1IF following any such change in operating mode.

10.1.4 CCP PRESCALER

There are four prescaler settings, specified by bits CCP1M3:CCP1M0. Whenever the CCP module is turned off, or the CCP module is not in Capture mode, the prescaler counter is cleared. This means that any reset will clear the prescaler counter.

Switching from one capture prescaler to another may generate an interrupt. Also, the prescaler counter will not be cleared, therefore the first capture may be from a non-zero prescaler. Example 10-1 shows the recommended method for switching between capture prescalers. This example also clears the prescaler counter and will not generate the “false” interrupt.

EXAMPLE 10-1: CHANGING BETWEEN CAPTURE PRESCALERS

```
CLRF   CCP1CON      ; Turn CCP module off
MOVLW  NEW_CAPT_PS ; Load the W reg with
                        ; the new prescaler
                        ; mode value and CCP ON
MOVWF  CCP1CON      ; Load CCP1CON with
                        ; this value
```

10.2 Compare Mode

Applicable Devices													
61	62	62A	R62	63	R63	64	64A	R64	65	65A	R65	66	67

In Compare mode, the 16-bit CCPR1 register value is constantly compared against the TMR1 register pair value. When a match occurs, the RC2/CCP1 pin is:

- Driven High
- Driven Low
- Remains Unchanged

The action on the pin is based on the value of control bits CCP1M3:CCP1M0 (CCP1CON<3:0>). At the same time interrupt flag bit CCP1IF is set.

FIGURE 10-3: COMPARE MODE OPERATION BLOCK DIAGRAM



10.2.1 CCP PIN CONFIGURATION

The user must configure the RC2/CCP1 pin as an output by clearing the TRISC<2> bit.

Note: Clearing the CCP1CON register will force the RC2/CCP1 compare output latch to the default low level. This is not the data latch.

10.2.1 TIMER1 MODE SELECTION

Timer1 must be running in Timer mode or Synchronized Counter mode if the CCP module is using the compare feature. In Asynchronous Counter mode, the compare operation may not work.

10.2.2 SOFTWARE INTERRUPT MODE

When Generate Software Interrupt is chosen, the CCP1 pin is not affected. Only a CCP interrupt is generated (if enabled).

10.2.3 SPECIAL EVENT TRIGGER

In this mode, an internal hardware trigger is generated which may be used to initiate an action.

The special event trigger output of CCP1 and CCP2 resets the TMR1 register pair. This allows the CCPR1H:CCPR1L and CCPR2H:CCPR2L registers to effectively be 16-bit programmable period register(s) for Timer1.

For compatibility issues, the special event trigger output of CCP1 (PIC16C72) and CCP2 (all other PIC16C7X devices) also starts an A/D conversion.

Note: The “special event trigger” from the CCP1 and CCP2 modules will not set interrupt flag bit TMR1IF (PIR1<0>).

PIC16C6X

10.3 PWM Mode

Applicable Devices													
61	62	62A	R62	63	R63	64	64A	R64	65	65A	R65	66	67

In Pulse Width Modulation (PWM) mode, the CCP1 pin produces up to a 10-bit resolution PWM output. Since the CCP1 pin is multiplexed with the PORTC data latch, the TRISC<2> bit must be cleared to make the CCP1 pin an output.

Note: Clearing the CCP1CON register will force the CCP1 PWM output latch to the default low level. This is not the PORTC I/O data latch.

Figure 10-4 shows a simplified block diagram of the CCP module in PWM mode.

For a step by step procedure on how to set up the CCP module for PWM operation, see Section 10.3.3.

FIGURE 10-4: SIMPLIFIED PWM BLOCK DIAGRAM



A PWM output (Figure 10-5) has a time base (period) and a time that the output stays high (duty cycle). The frequency of the PWM is the inverse of the period (1/period).

FIGURE 10-5: PWM OUTPUT



10.3.1 PWM PERIOD

The PWM period is specified by writing to the PR2 register. The PWM period can be calculated using the following formula:

$$\text{PWM period} = [(PR2) + 1] \cdot 4 \cdot \text{Tosc} \cdot (\text{TMR2 prescale value})$$

PWM frequency is defined as $1 / [\text{PWM period}]$.

When TMR2 is equal to PR2, the following three events occur on the next increment cycle:

- TMR2 is cleared
- The PWM duty cycle is latched from CCPR1L into CCPR1H
- The CCP1 pin is set (exception: if PWM duty cycle = 0%, the CCP1 pin will not be set)

Note: The Timer2 postscale (see Section 9.1) is not used in the determination of the PWM frequency. The postscale could be used to have a servo update rate at a different frequency than the PWM output.

10.3.2 PWM DUTY CYCLE

The PWM duty cycle is specified by writing to the CCPR1L register and to the CCP1CON<5:4> bits. Up to 10-bit resolution is available: the CCPR1L contains the eight MSBs and the CCP1CON<5:4> contains the two LSBs. This 10-bit value is represented by CCPR1L:CCP1CON<5:4>. The following equation is used to calculate the PWM duty cycle in time:

$$\text{PWM duty cycle} = (\text{CCPR1L:CCP1CON<5:4>}) \cdot \text{Tosc} \cdot (\text{TMR2 prescale value})$$

CCPR1L and CCP1CON<5:4> can be written to at any time, but the duty cycle value is not latched into CCPR1H until after a match between PR2 and TMR2 occurs (i.e., the period is complete). In PWM mode, CCPR1H is a read-only register.

The CCPR1H register and a 2-bit internal latch are used to double buffer the PWM duty cycle. This double buffering is essential for glitchless PWM operation.

When the CCPR1H and 2-bit latch match TMR2 concatenated with an internal 2-bit Q clock or 2 bits of the TMR2 prescaler, the CCP1 pin is cleared.

Maximum PWM resolution (bits) for a given PWM frequency:

$$= \frac{\log\left(\frac{F_{\text{osc}}}{F_{\text{PWM}}}\right)}{\log(2)} \text{ bits}$$

Note: If the PWM duty cycle value is longer than the PWM period the CCP1 pin will not be forced to the low level.

EXAMPLE 10-2: PWM PERIOD AND DUTY CYCLE CALCULATION

Desired PWM frequency is 78.125 kHz,

Fosc = 20 MHz

TMR2 prescale = 1

$$1/78.125 \text{ kHz} = [(PR2) + 1] \cdot 4 \cdot 1/20 \text{ MHz} \cdot 1$$

$$12.8 \mu\text{s} = [(PR2) + 1] \cdot 4 \cdot 50 \text{ ns} \cdot 1$$

$$PR2 = 63$$

Find the maximum resolution of the duty cycle that can be used with a 78.125 kHz frequency and 20 MHz oscillator:

$$1/78.125 \text{ kHz} = 2^{\text{PWM RESOLUTION}} \cdot 1/20 \text{ MHz} \cdot 1$$

$$12.8 \mu\text{s} = 2^{\text{PWM RESOLUTION}} \cdot 50 \text{ ns} \cdot 1$$

$$256 = 2^{\text{PWM RESOLUTION}}$$

$$\log(256) = (\text{PWM Resolution}) \cdot \log(2)$$

$$8.0 = \text{PWM Resolution}$$

At most, an 8-bit resolution duty cycle can be obtained from a 78.125 kHz frequency and a 20 MHz oscillator, i.e., $0 \leq \text{CCPR1L:CCP1CON}<5:4> \leq 255$. Any value greater than 255 will result in a 100% duty cycle.

In order to achieve higher resolution, the PWM frequency must be decreased. In order to achieve higher PWM frequency, the resolution must be decreased.

Table 10-3 lists example PWM frequencies and resolutions for Fosc = 20 MHz. The TMR2 prescaler and PR2 values are also shown.

10.3.3 SET-UP FOR PWM OPERATION

The following steps should be taken when configuring the CCP module for PWM operation:

1. Set the PWM period by writing to the PR2 register.
2. Set the PWM duty cycle by writing to the CCPR1L register and CCP1CON<5:4> bits.
3. Make the CCP1 pin an output by clearing the TRISC<2> bit.
4. Set the TMR2 prescale value and enable Timer2 by writing to T2CON.
5. Configure the CCP1 module for PWM operation.

TABLE 10-3: EXAMPLE PWM FREQUENCIES AND RESOLUTIONS AT 20 MHz

PWM Frequency	1.22 kHz	4.88 kHz	19.53 kHz	78.12 kHz	156.3 kHz	208.3 kHz
Timer Prescaler (1, 4, 16)	16	4	1	1	1	1
PR2 Value	0xFF	0xFF	0xFF	0x3F	0x1F	0x17
Maximum Resolution (bits)	10	10	10	8	7	5.5

TABLE 10-4: REGISTERS ASSOCIATED WITH TIMER1, CAPTURE AND COMPARE

Add	Name	Bit 7	Bit 6	Bit 5	Bit 4	Bit 3	Bit 2	Bit 1	Bit 0	Value on: POR, BOR	Value on all other Resets
0Bh,8Bh 10Bh,18Bh	INTCON	GIE	PEIE	T0IE	INTE	RBIE	T0IF	INTF	RBIF	0000 000x	0000 000u
0Ch	PIR1	PSPIF ⁽²⁾	⁽³⁾	RCIF ⁽¹⁾	TXIF ⁽¹⁾	SSPIF	CCP1IF	TMR2IF	TMR1IF	0000 0000	0000 0000
0Dh ⁽⁴⁾	PIR2	—	—	—	—	—	—	—	CCP2IF	---- --0	---- --0
8Ch	PIE1	PSPIE ⁽²⁾	⁽³⁾	RCIE ⁽¹⁾	TXIE ⁽¹⁾	SSPIE	CCP1IE	TMR2IE	TMR1IE	0000 0000	0000 0000
8Dh ⁽⁴⁾	PIE2	—	—	—	—	—	—	—	CCP2IE	---- --0	---- --0
87h	TRISC	PORTC Data Direction register								1111 1111	1111 1111
0Eh	TMR1L	Holding register for the Least Significant Byte of the 16-bit TMR1 register								xxxx xxxx	uuuu uuuu
0Fh	TMR1H	Holding register for the Most Significant Byte of the 16-bit TMR1 register								xxxx xxxx	uuuu uuuu
10h	T1CON	—	—	T1CKPS1	T1CKPS0	T1OSCEN	T1SYNC	TMR1CS	TMR1ON	--00 0000	--uu uuuu
15h	CCPR1L	Capture/Compare/PWM1 (LSB)								xxxx xxxx	uuuu uuuu
16h	CCPR1H	Capture/Compare/PWM1 (MSB)								xxxx xxxx	uuuu uuuu
17h	CCP1CON	—	—	CCP1X	CCP1Y	CCP1M3	CCP1M2	CCP1M1	CCP1M0	--00 0000	--00 0000
1Bh ⁽⁴⁾	CCPR2L	Capture/Compare/PWM2 (LSB)								xxxx xxxx	uuuu uuuu
1Ch ⁽⁴⁾	CCPR2H	Capture/Compare/PWM2 (MSB)								xxxx xxxx	uuuu uuuu
1Dh ⁽⁴⁾	CCP2CON	—	—	CCP2X	CCP2Y	CCP2M3	CCP2M2	CCP2M1	CCP2M0	--00 0000	--00 0000

Legend: x = unknown, u = unchanged, - = unimplemented locations read as '0'. Shaded cells are not used in these modes.

Note 1: These bits are associated with the USART module, which is implemented on the PIC16C63/R63/65/65A/R65/66/67 only.

2: Bits PSPIE and PSPIF are reserved on the PIC16C62/62A/R62/63/R63/66, always maintain these bits clear.

3: The PIR1<6> and PIE1<6> bits are reserved, always maintain these bits clear.

4: These registers are associated with the CCP2 module, which is only implemented on the PIC16C63/R63/65/65A/R65/66/67.

PIC16C6X

TABLE 10-5: REGISTERS ASSOCIATED WITH PWM AND TIMER2

Addr	Name	Bit 7	Bit 6	Bit 5	Bit 4	Bit 3	Bit 2	Bit 1	Bit 0	Value on: POR, BOR	Value on all other Resets
0Bh,8Bh 10Bh,18Bh	INTCON	GIE	PEIE	TOIE	INTE	RBIE	T0IF	INTF	RBIF	0000 000x	0000 000u
0Ch	PIR1	PSPIF ⁽²⁾	⁽³⁾	RCIF ⁽¹⁾	TXIF ⁽¹⁾	SSPIF	CCP1IF	TMR2IF	TMR1IF	0000 0000	0000 0000
0Dh ⁽⁴⁾	PIR2	—	—	—	—	—	—	—	CCP2IF	----- 0	----- 0
8Ch	PIE1	PSPIE ⁽²⁾	⁽³⁾	RCIE ⁽¹⁾	TXIE ⁽¹⁾	SSPIE	CCP1IE	TMR2IE	TMR1IE	0000 0000	0000 0000
8Dh ⁽⁴⁾	PIE2	—	—	—	—	—	—	—	CCP2IE	----- 0	----- 0
87h	TRISC	PORTC Data Direction register								1111 1111	1111 1111
11h	TMR2	Timer2 module's register								0000 0000	0000 0000
92h	PR2	Timer2 module's Period register								1111 1111	1111 1111
12h	T2CON	—	TOUTPS3	TOUTPS2	TOUTPS1	TOUTPS0	TMR2ON	T2CKPS1	T2CKPS0	-000 0000	-000 0000
15h	CCPR1L	Capture/Compare/PWM1 (LSB)								xxxx xxxx	uuuu uuuu
16h	CCPR1H	Capture/Compare/PWM1 (MSB)								xxxx xxxx	uuuu uuuu
17h	CCP1CON	—	—	CCP1X	CCP1Y	CCP1M3	CCP1M2	CCP1M1	CCP1M0	--00 0000	--00 0000
1Bh ⁽⁴⁾	CCPR2L	Capture/Compare/PWM2 (LSB)								xxxx xxxx	uuuu uuuu
1Ch ⁽⁴⁾	CCPR2H	Capture/Compare/PWM2 (MSB)								xxxx xxxx	uuuu uuuu
1Dh ⁽⁴⁾	CCP2CON	—	—	CCP2X	CCP2Y	CCP2M3	CCP2M2	CCP2M1	CCP2M0	--00 0000	--00 0000

Legend: x = unknown, u = unchanged, - = unimplemented locations read as '0'. Shaded cells are not used in this mode.

Note 1: These bits are associated with the USART module, which is implemented on the PIC16C63/R63/65/65A/R65/66/67 only.

2: Bits PSPIE and PSPIF are reserved on the PIC16C62/62A/R62/63/R63/66, always maintain these bits clear.

3: The PIR1<6> and PIE1<6> bits are reserved, always maintain these bits clear.

4: These registers are associated with the CCP2 module, which is only implemented on the PIC16C63/R63/65/65A/R65/66/67.

11.0 SYNCHRONOUS SERIAL PORT (SSP) MODULE

11.1 SSP Module Overview

The Synchronous Serial Port (SSP) module is a serial interface useful for communicating with other peripheral or microcontroller devices. These peripheral devices may be Serial EEPROMs, shift registers, display drivers, A/D converters, etc. The SSP module can operate in one of two modes:

- Serial Peripheral Interface (SPI)
- Inter-Integrated Circuit (I²C)

The SSP module in I²C mode works the same in all PIC16C6X devices that have an SSP module. However the SSP Module in SPI mode has differences between the PIC16C66/67 and the other PIC16C6X devices.

The register definitions and operational description of SPI mode has been split into two sections because of the differences between the PIC16C66/67 and the other PIC16C6X devices. The default reset values of both the SPI modules is the same regardless of the device:

11.2 SPI Mode for PIC16C62/62A/R62/63/R63/64/64A/R64/65/65A/R65	84
11.3 SPI Mode for PIC16C66/67	89
11.4 I ² C™ Overview.....	95
11.5 SSP I ² C Operation	99

Refer to Application Note AN578, "Use of the SSP Module in the I²C Multi-Master Environment."

11.2 SPI Mode for PIC16C62/62A/R62/63/ R63/64/64A/R64/65/65A/R65

This section contains register definitions and operational characteristics of the SPI module for the PIC16C62, PIC16C62A, PIC16CR62, PIC16C63, PIC16CR63, PIC16C64, PIC16C64A, PIC16CR64, PIC16C65, PIC16C65A, PIC16CR65.

FIGURE 11-1: SSPSTAT: SYNC SERIAL PORT STATUS REGISTER (ADDRESS 94h)

U-0	U-0	R-0	R-0	R-0	R-0	R-0	R-0	
—	—	D/ \bar{A}	P	S	R/ \bar{W}	UA	BF	
bit7								bit0

R = Readable bit
W = Writable bit
U = Unimplemented bit, read as '0'
- n = Value at POR reset

bit 7-6: **Unimplemented:** Read as '0'

bit 5: **D/ \bar{A} :** Data/Address bit (I^2C mode only)
1 = Indicates that the last byte received or transmitted was data
0 = Indicates that the last byte received or transmitted was address

bit 4: **P:** Stop bit (I^2C mode only. This bit is cleared when the SSP module is disabled, SSPEN is cleared)
1 = Indicates that a stop bit has been detected last (this bit is '0' on RESET)
0 = Stop bit was not detected last

bit 3: **S:** Start bit (I^2C mode only. This bit is cleared when the SSP module is disabled, SSPEN is cleared)
1 = Indicates that a start bit has been detected last (this bit is '0' on RESET)
0 = Start bit was not detected last

bit 2: **R/ \bar{W} :** Read/Write bit information (I^2C mode only)
This bit holds the R/W bit information following the last address match. This bit is valid from the address match to the next start bit, stop bit, or $\bar{A}CK$ bit.
1 = Read
0 = Write

bit 1: **UA:** Update Address (10-bit I^2C mode only)
1 = Indicates that the user needs to update the address in the SSPADD register
0 = Address does not need to be updated

bit 0: **BF:** Buffer Full Status bit

Receive (SPI and I^2C modes)
1 = Receive complete, SSPBUF is full
0 = Receive not complete, SSPBUF is empty

Transmit (I^2C mode only)
1 = Transmit in progress, SSPBUF is full
0 = Transmit complete, SSPBUF is empty

FIGURE 11-2: SSPCON: SYNC SERIAL PORT CONTROL REGISTER (ADDRESS 14h)

R/W-0	R/W-0	R/W-0	R/W-0	R/W-0	R/W-0	R/W-0	R/W-0
WCOL	SSPOV	SSPEN	CKP	SSPM3	SSPM2	SSPM1	SSPM0
bit7						bit0	

R = Readable bit
W = Writable bit
U = Unimplemented bit, read as '0'
- n = Value at POR reset

bit 7: **WCOL**: Write Collision Detect bit
1 = The SSPBUF register is written while it is still transmitting the previous word (must be cleared in software)
0 = No collision

bit 6: **SSPOV**: Receive Overflow Detect bit
In SPI mode
1 = A new byte is received while the SSPBUF register is still holding the previous data. In case of overflow, the data in SSPSR register is lost. Overflow can only occur in slave mode. The user must read the SSPBUF, even if only transmitting data, to avoid setting overflow. In master mode the overflow bit is not set since each new reception (and transmission) is initiated by writing to the SSPBUF register.
0 = No overflow
In I²C mode
1 = A byte is received while the SSPBUF register is still holding the previous byte. SSPOV is a "don't care" in transmit mode. SSPOV must be cleared in software in either mode.
0 = No overflow

bit 5: **SSPEN**: Synchronous Serial Port Enable bit
In SPI mode
1 = Enables serial port and configures SCK, SDO, and SDI as serial port pins
0 = Disables serial port and configures these pins as I/O port pins
In I²C mode
1 = Enables the serial port and configures the SDA and SCL pins as serial port pins
0 = Disables serial port and configures these pins as I/O port pins
In both modes, when enabled, these pins must be properly configured as input or output.

bit 4: **CKP**: Clock Polarity Select bit
In SPI mode
1 = Idle state for clock is a high level. Transmit happens on falling edge, receive on rising edge.
0 = Idle state for clock is a low level. Transmit happens on rising edge, receive on falling edge.
In I²C mode
SCK release control
1 = Enable clock
0 = Holds clock low (clock stretch) (Used to ensure data setup time)

bit 3-0: **SSPM3:SSPM0**: Synchronous Serial Port Mode Select bits
0000 = SPI master mode, clock = Fosc/4
0001 = SPI master mode, clock = Fosc/16
0010 = SPI master mode, clock = Fosc/64
0011 = SPI master mode, clock = TMR2 output/2
0100 = SPI slave mode, clock = SCK pin. \overline{SS} pin control enabled.
0101 = SPI slave mode, clock = SCK pin. \overline{SS} pin control disabled. \overline{SS} can be used as I/O pin.
0110 = I²C slave mode, 7-bit address
0111 = I²C slave mode, 10-bit address
1011 = I²C firmware controlled Master Mode (slave idle)
1110 = I²C slave mode, 7-bit address with start and stop bit interrupts enabled
1111 = I²C slave mode, 10-bit address with start and stop bit interrupts enabled

11.2.1 OPERATION OF SSP MODULE IN SPI MODE

Applicable Devices													
61	62	62A	R62	63	R63	64	64A	R64	65	65A	R65	66	67

The SPI mode allows 8-bits of data to be synchronously transmitted and received simultaneously. To accomplish communication, typically three pins are used:

- Serial Data Out (SDO)
- Serial Data In (SDI)
- Serial Clock (SCK)

Additionally a fourth pin may be used when in a slave mode of operation:

- Slave Select (\overline{SS})

When initializing the SPI, several options need to be specified. This is done by programming the appropriate control bits in the SSPCON register (SSPCON<5:0>). These control bits allow the following to be specified:

- Master Mode (SCK is the clock output)
- Slave Mode (SCK is the clock input)
- Clock Polarity (Output/Input data on the Rising/Falling edge of SCK)
- Clock Rate (Master mode only)
- Slave Select Mode (Slave mode only)

The SSP consists of a transmit/receive Shift Register (SSPSR) and a Buffer register (SSPBUF). The SSPSR shifts the data in and out of the device, MSb first. The SSPBUF holds the data that was written to the SSPSR, until the received data is ready. Once the 8-bits of data have been received, that byte is moved to the SSPBUF register. Then the Buffer Full bit, BF (SSPSTAT<0>) and flag bit SSPIF are set. This double buffering of the received data (SSPBUF) allows the next byte to start reception before reading the data that was just received. Any write to the SSPBUF register during transmission/reception of data will be ignored, and the write collision detect bit, WCOL (SSPCON<7>) will be set. User software must clear bit WCOL so that it can be determined if the following write(s) to the SSPBUF completed successfully. When the application software is expecting to receive valid data, the SSPBUF register should be read before the next byte of data to transfer is written to the SSPBUF register. The Buffer Full bit BF (SSPSTAT<0>) indicates when the SSPBUF register has been loaded with the received data (transmission is complete). When the SSPBUF is read, bit BF is cleared. This data may be irrelevant if the SPI is only a transmitter. Generally the SSP Interrupt is used to determine when the transmission/reception has completed. The SSPBUF register must be read and/or written. If the interrupt method is not going to be used, then software polling can be done to ensure that a write collision does not occur. Example 11-1 shows the loading of the SSPBUF (SSPSR) register for data transmission. The shaded instruction is only required if the received data is meaningful.

EXAMPLE 11-1: LOADING THE SSPBUF (SSPSR) REGISTER

```

BSF STATUS, RP0 ;Specify Bank 1
LOOP BTFSS SSPSTAT, BF ;Has data been
;received
; (transmit
;complete)?

GOTO LOOP ;No

BCF STATUS, RP0 ;Specify Bank 0
MOVWF SSPBUF, W ;W reg = contents
;of SSPBUF

MOVWF RXDATA ;Save in user RAM
MOVWF TXDATA, W ;W reg = contents
; of TXDATA

MOVWF SSPBUF ;New data to xmit
    
```

The block diagram of the SSP module, when in SPI mode (Figure 11-3), shows that the SSPSR register is not directly readable or writable, and can only be accessed from addressing the SSPBUF register. Additionally, the SSP status register (SSPSTAT) indicates the various status conditions.

FIGURE 11-3: SSP BLOCK DIAGRAM (SPI MODE)



To enable the serial port, SSP enable bit SSPEN (SSPCON<5>) must be set. To reset or reconfigure SPI mode, clear enable bit SSPEN, re-initialize SSPCON register, and then set enable bit SSPEN. This configures the SDI, SDO, SCK, and \overline{SS} pins as serial port pins. For the pins to behave as the serial port function, they must have their data direction bits (in the TRIS register) appropriately programmed. That is:

- SDI must have TRISC<4> set
- SDO must have TRISC<5> cleared
- SCK (Master mode) must have TRISC<3> cleared
- SCK (Slave mode) must have TRISC<3> set
- \overline{SS} must have TRISA<5> set (if implemented)

Any serial port function that is not desired may be overridden by programming the corresponding data direction (TRIS) register to the opposite value. An example would be in master mode where you are only sending data (to a display driver), then both SDI and \overline{SS} could be used as general purpose outputs by clearing their corresponding TRIS register bits.

Figure 11-4 shows a typical connection between two microcontrollers. The master controller (Processor 1) initiates the data transfer by sending the SCK signal. Data is shifted out of both shift registers on their programmed clock edge, and latched on the opposite edge of the clock. Both processors should be programmed to the same Clock Polarity (CKP), then both controllers would send and receive data at the same time. Whether the data is meaningful (or dummy data) depends on the application software. This leads to three scenarios for data transmission:

- Master sends data — Slave sends dummy data
- Master sends data — Slave sends data
- Master sends dummy data — Slave sends data

The master can initiate the data transfer at any time because it controls the SCK. The master determines when the slave (Processor 2) is to broadcast data by the software protocol.

In master mode the data is transmitted/received as soon as the SSPBUF register is written to. If the SPI is only going to receive, the SCK output could be disabled (programmed as an input). The SSPSR register will continue to shift in the signal present on the SDI pin at the programmed clock rate. As each byte is received, it will be loaded into the SSPBUF register as if a normal received byte (interrupts and status bits appropriately set). This could be useful in receiver applications as a “line activity monitor” mode.

In slave mode, the data is transmitted and received as the external clock pulses appear on SCK. When the last bit is latched interrupt flag bit SSPIF (PIR1<3>) is set.

The clock polarity is selected by appropriately programming bit CKP (SSPCON<4>). This then would give waveforms for SPI communication as shown in Figure 11-5 and Figure 11-6 where the MSB is transmitted first. In master mode, the SPI clock rate (bit rate) is user programmable to be one of the following:

- $F_{osc}/4$ (or T_{CY})
- $F_{osc}/16$ (or $4 \cdot T_{CY}$)
- $F_{osc}/64$ (or $16 \cdot T_{CY}$)
- Timer2 output/2

This allows a maximum bit clock frequency (at 20 MHz) of 5 MHz. When in slave mode the external clock must meet the minimum high and low times.

In sleep mode, the slave can transmit and receive data and wake the device from sleep.

FIGURE 11-4: SPI MASTER/SLAVE CONNECTION



The \overline{SS} pin allows a synchronous slave mode. The SPI must be in slave mode (SSPCON<3:0> = 04h) and the TRISA<5> bit must be set for synchronous slave mode to be enabled. When the \overline{SS} pin is low, transmission and reception are enabled and the SDO pin is driven. When the \overline{SS} pin goes high, the SDO pin is no longer driven, even if in the middle of a transmitted byte, and becomes a floating output. If the \overline{SS} pin is taken low without resetting SPI mode, the transmission will continue from the

point at which it was taken high. External pull-up/pull-down resistors may be desirable, depending on the application.

To emulate two-wire communication, the SDO pin can be connected to the SDI pin. When the SPI needs to operate as a receiver the SDO pin can be configured as an input. This disables transmissions from the SDO. The SDI can always be left as an input (SDI function) since it cannot create a bus conflict.

FIGURE 11-5: SPI MODE TIMING, MASTER MODE OR SLAVE MODE W/O \overline{SS} CONTROL



FIGURE 11-6: SPI MODE TIMING, SLAVE MODE WITH \overline{SS} CONTROL



TABLE 11-1: REGISTERS ASSOCIATED WITH SPI OPERATION

Address	Name	Bit 7	Bit 6	Bit 5	Bit 4	Bit 3	Bit 2	Bit 1	Bit 0	Value on: POR, BOR	Value on all other Resets
0Bh,8Bh	INTCON	GIE	PEIE	TOIE	INTE	RBIE	T0IF	INTF	RBIF	0000 000x	0000 000u
0Ch	PIR1	PSPIF ⁽²⁾	⁽³⁾	RCIF ⁽¹⁾	TXIF ⁽¹⁾	SSPIF	CCP1IF	TMR2IF	TMR1IF	0000 0000	0000 0000
8Ch	PIE1	PSPIE ⁽²⁾	⁽³⁾	RCIE ⁽¹⁾	TXIE ⁽¹⁾	SSPIE	CCP1IE	TMR2IE	TMR1IE	0000 0000	0000 0000
13h	SSPBUF	Synchronous Serial Port Receive Buffer/Transmit Register								xxxxx xxxxx	uuuu uuuu
14h	SSPCON	WCOL	SSPOV	SSPEN	CKP	SSPM3	SSPM2	SSPM1	SSPM0	0000 0000	0000 0000
85h	TRISA	—	—	PORTA Data Direction Register						--11 1111	--11 1111
87h	TRISC	PORTC Data Direction Register								1111 1111	1111 1111
94h	SSPSTAT	—	—	D/A	P	S	R/W	UA	BF	--00 0000	--00 0000

Legend: x = unknown, u = unchanged, - = unimplemented locations read as '0'. Shaded cells are not used by SSP module in SPI mode.

Note 1: These bits are associated with the USART which is implemented on the PIC16C63/R63/65/65A/R65 only.

Note 2: PSPIF and PSPIE are reserved on the PIC16C62/62A/R62/63/R63, always maintain these bits clear.

Note 3: PIR1<6> and PIE1<6> are reserved, always maintain these bits clear.

11.3 SPI Mode for PIC16C66/67

This section contains register definitions and operational characteristics of the SPI module on the PIC16C66 and PIC16C67 only.

FIGURE 11-7: SSPSTAT: SYNC SERIAL PORT STATUS REGISTER (ADDRESS 94h)(PIC16C66/67)

R/W-0	R/W-0	R-0	R-0	R-0	R-0	R-0	R-0
SMP	CKE	D/A	P	S	R/W	UA	BF
bit7						bit0	
<p>bit 7: SMP: SPI data input sample phase SPI Master Mode 1 = Input data sampled at end of data output time 0 = Input data sampled at middle of data output time SPI Slave Mode SMP must be cleared when SPI is used in slave mode</p> <p>bit 6: CKE: SPI Clock Edge Select (Figure 11-11, Figure 11-12, and Figure 11-13) CKP = 0 1 = Data transmitted on rising edge of SCK 0 = Data transmitted on falling edge of SCK CKP = 1 1 = Data transmitted on falling edge of SCK 0 = Data transmitted on rising edge of SCK</p> <p>bit 5: D/A: Data/Address bit (I²C mode only) 1 = Indicates that the last byte received or transmitted was data 0 = Indicates that the last byte received or transmitted was address</p> <p>bit 4: P: Stop bit (I²C mode only. This bit is cleared when the SSP module is disabled, or when the Start bit is detected last, SSPEN is cleared) 1 = Indicates that a stop bit has been detected last (this bit is '0' on RESET) 0 = Stop bit was not detected last</p> <p>bit 3: S: Start bit (I²C mode only. This bit is cleared when the SSP module is disabled, or when the Stop bit is detected last, SSPEN is cleared) 1 = Indicates that a start bit has been detected last (this bit is '0' on RESET) 0 = Start bit was not detected last</p> <p>bit 2: R/W: Read/Write bit information (I²C mode only) This bit holds the R/W bit information following the last address match. This bit is only valid from the address match to the next start bit, stop bit, or \overline{ACK} bit. 1 = Read 0 = Write</p> <p>bit 1: UA: Update Address (10-bit I²C mode only) 1 = Indicates that the user needs to update the address in the SSPADD register 0 = Address does not need to be updated</p> <p>bit 0: BF: Buffer Full Status bit Receive (SPI and I²C modes) 1 = Receive complete, SSPBUF is full 0 = Receive not complete, SSPBUF is empty Transmit (I²C mode only) 1 = Transmit in progress, SSPBUF is full 0 = Transmit complete, SSPBUF is empty</p>							

R = Readable bit
 W = Writable bit
 U = Unimplemented bit, read as '0'
 - n = Value at POR reset

FIGURE 11-8: SSPCON: SYNC SERIAL PORT CONTROL REGISTER (ADDRESS 14h)(PIC16C66/67)

R/W-0	R/W-0	R/W-0	R/W-0	R/W-0	R/W-0	R/W-0	R/W-0
WCOL	SSPOV	SSPEN	CKP	SSPM3	SSPM2	SSPM1	SSPM0
bit7						bit0	

R = Readable bit
 W = Writable bit
 U = Unimplemented bit, read as '0'
 - n = Value at POR reset

bit 7: **WCOL**: Write Collision Detect bit
 1 = The SSPBUF register is written while it is still transmitting the previous word (must be cleared in software)
 0 = No collision

bit 6: **SSPOV**: Receive Overflow Indicator bit

In SPI mode
 1 = A new byte is received while the SSPBUF register is still holding the previous data. In case of overflow, the data in SSPSR is lost. Overflow can only occur in slave mode. The user must read the SSPBUF, even if only transmitting data, to avoid setting overflow. In master mode the overflow bit is not set since each new reception (and transmission) is initiated by writing to the SSPBUF register.
 0 = No overflow

In I²C mode
 1 = A byte is received while the SSPBUF register is still holding the previous byte. SSPOV is a "don't care" in transmit mode. SSPOV must be cleared in software in either mode.
 0 = No overflow

bit 5: **SSPEN**: Synchronous Serial Port Enable bit

In SPI mode
 1 = Enables serial port and configures SCK, SDO, and SDI as serial port pins
 0 = Disables serial port and configures these pins as I/O port pins

In I²C mode
 1 = Enables the serial port and configures the SDA and SCL pins as serial port pins
 0 = Disables serial port and configures these pins as I/O port pins
 In both modes, when enabled, these pins must be properly configured as input or output.

bit 4: **CKP**: Clock Polarity Select bit

In SPI mode
 1 = Idle state for clock is a high level
 0 = Idle state for clock is a low level

In I²C mode
SCK release control
 1 = Enable clock
 0 = Holds clock low (clock stretch) (Used to ensure data setup time)

bit 3-0: **SSPM3:SSPM0**: Synchronous Serial Port Mode Select bits

0000 = SPI master mode, clock = Fosc/4
 0001 = SPI master mode, clock = Fosc/16
 0010 = SPI master mode, clock = Fosc/64
 0011 = SPI master mode, clock = TMR2 output/2
 0100 = SPI slave mode, clock = SCK pin. \overline{SS} pin control enabled.
 0101 = SPI slave mode, clock = SCK pin. \overline{SS} pin control disabled. \overline{SS} can be used as I/O pin
 0110 = I²C slave mode, 7-bit address
 0111 = I²C slave mode, 10-bit address
 1011 = I²C firmware controlled master mode (slave idle)
 1110 = I²C slave mode, 7-bit address with start and stop bit interrupts enabled
 1111 = I²C slave mode, 10-bit address with start and stop bit interrupts enabled

11.3.1 SSP MODULE IN SPI MODE FOR PIC16C66/67

The SPI mode allows 8-bits of data to be synchronously transmitted and received simultaneously. To accomplish communication, typically three pins are used:

- Serial Data Out (SDO) RC5/SDO
- Serial Data In (SDI) RC4/SDI/SDA
- Serial Clock (SCK) RC3/SCK/SCL

Additionally a fourth pin may be used when in a slave mode of operation:

- Slave Select (\overline{SS}) RA5/ \overline{SS}

When initializing the SPI, several options need to be specified. This is done by programming the appropriate control bits in the SSPCON register (SSPCON<5:0>) and SSPSTAT<7:6>. These control bits allow the following to be specified:

- Master Mode (SCK is the clock output)
- Slave Mode (SCK is the clock input)
- Clock Polarity (Idle state of SCK)
- Clock edge (output data on rising/falling edge of SCK)
- Clock Rate (Master mode only)
- Slave Select Mode (Slave mode only)

The SSP consists of a transmit/receive Shift Register (SSPSR) and a buffer register (SSPBUF). The SSPSR shifts the data in and out of the device, MSb first. The SSPBUF holds the data that was written to the SSPSR until the received data is ready. Once the 8-bits of data have been received, that byte is moved to the SSPBUF register. Then the buffer full detect bit BF (SSPSTAT<0>) and interrupt flag bit SSPIF (PIR1<3>) are set. This double buffering of the received data (SSPBUF) allows the next byte to start reception before reading the data that was just received. Any write to the SSPBUF register during transmission/reception of data will be ignored, and the write collision detect bit WCOL (SSPCON<7>) will be set. User software must clear the WCOL bit so that it can be determined if the following write(s) to the SSPBUF register completed successfully. When the application software is expecting to receive valid data, the SSPBUF should be read before the next byte of data to transfer is written to the SSPBUF. Buffer full bit BF (SSPSTAT<0>) indicates when SSPBUF has been loaded with the received data (transmission is complete). When the SSPBUF is read, bit BF is cleared. This data may be irrelevant if the SPI is only a transmitter. Generally the SSP Interrupt is used to determine when the transmission/reception has completed. The SSPBUF must be read and/or written. If the interrupt method is not going to be used, then software polling can be done to ensure that a write collision does not occur. Example 11-2 shows the loading of the SSPBUF (SSPSR) for data transmission. The shaded instruction is only required if the received data is meaningful.

EXAMPLE 11-2: LOADING THE SSPBUF (SSPSR) REGISTER (PIC16C66/67)

```

BCF STATUS, RP1 ;Specify Bank 1
BSF STATUS, RP0 ;
LOOP BTFSS SSPSTAT, BF ;Has data been
;received
;(transmit
;complete)?
GOTO LOOP ;No
BCF STATUS, RP0 ;Specify Bank 0
MOVWF SSPBUF, W ;W reg = contents
; of SSPBUF
MOVWF RXDATA ;Save in user RAM
MOVWF TXDATA, W ;W reg = contents
; of TXDATA
MOVWF SSPBUF ;New data to xmit

```

The block diagram of the SSP module, when in SPI mode (Figure 11-9), shows that the SSPSR is not directly readable or writable, and can only be accessed from addressing the SSPBUF register. Additionally, the SSP status register (SSPSTAT) indicates the various status conditions.

FIGURE 11-9: SSP BLOCK DIAGRAM (SPI MODE)(PIC16C66/67)



Applicable Devices													
61	62	62A	R62	63	R63	64	64A	R64	65	65A	R65	66	67

To enable the serial port, SSP Enable bit, SSPEN (SSPCON<5>) must be set. To reset or reconfigure SPI mode, clear bit SSPEN, re-initialize the SSPCON register, and then set bit SSPEN. This configures the SDI, SDO, SCK, and \overline{SS} pins as serial port pins. For the pins to behave as the serial port function, they must have their data direction bits (in the TRISC register) appropriately programmed. That is:

- SDI must have TRISC<4> set
- SDO must have TRISC<5> cleared
- SCK (Master mode) must have TRISC<3> cleared
- SCK (Slave mode) must have TRISC<3> set
- \overline{SS} must have TRISA<5> set

Any serial port function that is not desired may be overridden by programming the corresponding data direction (TRIS) register to the opposite value. An example would be in master mode where you are only sending data (to a display driver), then both SDI and \overline{SS} could be used as general purpose outputs by clearing their corresponding TRIS register bits.

Figure 11-10 shows a typical connection between two microcontrollers. The master controller (Processor 1) initiates the data transfer by sending the SCK signal. Data is shifted out of both shift registers on their programmed clock edge, and latched on the opposite edge of the clock. Both processors should be programmed to same Clock Polarity (CKP), then both controllers would send and receive data at the same time. Whether the data is meaningful (or dummy data) depends on the application firmware. This leads to three scenarios for data transmission:

- Master sends data — Slave sends dummy data
- Master sends data — Slave sends data
- Master sends dummy data — Slave sends data

The master can initiate the data transfer at any time because it controls the SCK. The master determines when the slave (Processor 2) is to broadcast data by the firmware protocol.

In master mode the data is transmitted/received as soon as the SSPBUF register is written to. If the SPI is only going to receive, the SCK output could be disabled (programmed as an input). The SSPSR register will continue to shift in the signal present on the SDI pin at the programmed clock rate. As each byte is received, it will be loaded into the SSPBUF register as if a normal received byte (interrupts and status bits appropriately set). This could be useful in receiver applications as a “line activity monitor” mode.

In slave mode, the data is transmitted and received as the external clock pulses appear on SCK. When the last bit is latched the interrupt flag bit SSPIF (PIR1<3>) is set.

The clock polarity is selected by appropriately programming bit CKP (SSPCON<4>). This then would give waveforms for SPI communication as shown in Figure 11-11, Figure 11-12, and Figure 11-13 where the MSB is transmitted first. In master mode, the SPI clock rate (bit rate) is user programmable to be one of the following:

- Fosc/4 (or Tcy)
- Fosc/16 (or 4 • Tcy)
- Fosc/64 (or 16 • Tcy)
- Timer2 output/2

This allows a maximum bit clock frequency (at 20 MHz) of 5 MHz. When in slave mode the external clock must meet the minimum high and low times.

In sleep mode, the slave can transmit and receive data and wake the device from sleep.

FIGURE 11-10: SPI MASTER/SLAVE CONNECTION (PIC16C66/67)



The \overline{SS} pin allows a synchronous slave mode. The SPI must be in slave mode (SSPCON<3:0> = 04h) and the TRISA<5> bit must be set for the synchronous slave mode to be enabled. When the \overline{SS} pin is low, transmission and reception are enabled and the SDO pin is driven. When the \overline{SS} pin goes high, the SDO pin is no longer driven, even if in the middle of a transmitted byte, and becomes a floating output. If the \overline{SS} pin is taken low without resetting SPI mode, the transmission will continue from the point at which it was taken high. External pull-up/pull-down resistors may be desirable, depending on the application.

Note: When the SPI is in Slave Mode with \overline{SS} pin control enabled, (SSPCON<3:0> = 0100) the SPI module will reset if the \overline{SS} pin is set to VDD.

Note: If the SPI is used in Slave Mode with CKE = '1', then the \overline{SS} pin control must be enabled.

To emulate two-wire communication, the SDO pin can be connected to the SDI pin. When the SPI needs to operate as a receiver the SDO pin can be configured as an input. This disables transmissions from the SDO. The SDI can always be left as an input (SDI function) since it cannot create a bus conflict.

FIGURE 11-11: SPI MODE TIMING, MASTER MODE (PIC16C66/67)



FIGURE 11-12: SPI MODE TIMING (SLAVE MODE WITH CKE = 0) (PIC16C66/67)



FIGURE 11-13: SPI MODE TIMING (SLAVE MODE WITH CKE = 1) (PIC16C66/67)



TABLE 11-2: REGISTERS ASSOCIATED WITH SPI OPERATION (PIC16C66/67)

Address	Name	Bit 7	Bit 6	Bit 5	Bit 4	Bit 3	Bit 2	Bit 1	Bit 0	Value on Power-on Reset	Value on all other resets
0Bh, 8Bh, 10Bh, 18Bh	INTCON	GIE	PEIE	T0IE	INTE	RBIE	T0IF	INTF	RBIF	0000 000x	0000 000u
0Ch	PIR1	PSPIF ⁽¹⁾	⁽²⁾	RCIF	TXIF	SSPIF	CCP1IF	TMR2IF	TMR1IF	0000 0000	0000 0000
8Ch	PIE1	PSPIE ⁽¹⁾	⁽²⁾	RCIE	TXIE	SSPIE	CCP1IE	TMR2IE	TMR1IE	0000 0000	0000 0000
13h	SSPBUF	Synchronous Serial Port Receive Buffer/Transmit Register								xxxx xxxx	uuuu uuuu
14h	SSPCON	WCOL	SSPOV	SSPEN	CKP	SSPM3	SSPM2	SSPM1	SSPM0	0000 0000	0000 0000
85h	TRISA	—	—	PORTA Data Direction register						--11 1111	--11 1111
87h	TRISC	PORTC Data Direction register								1111 1111	1111 1111
94h	SSPSTAT	SMP	CKE	D/Ā	P	S	R/W	UA	BF	0000 0000	0000 0000

Legend: x = unknown, u = unchanged, - = unimplemented locations read as '0'.

Shaded cells are not used by SSP module in SPI mode.

Note 1: PSPIF and PSPIE are reserved on the PIC16C66, always maintain these bits clear.

Note 2: PIR1<6> and PIE1<6> are reserved, always maintain these bits clear.

11.4 I²C™ Overview

This section provides an overview of the Inter-Integrated Circuit (I²C) bus, with Section 11.5 discussing the operation of the SSP module in I²C mode.

The I²C bus is a two-wire serial interface developed by the Philips® Corporation. The original specification, or standard mode, was for data transfers of up to 100 Kbps. The enhanced specification (fast mode) is also supported. This device will communicate with both standard and fast mode devices if attached to the same bus. The clock will determine the data rate.

The I²C interface employs a comprehensive protocol to ensure reliable transmission and reception of data. When transmitting data, one device is the “master” which initiates transfer on the bus and generates the clock signals to permit that transfer, while the other device(s) acts as the “slave.” All portions of the slave protocol are implemented in the SSP module’s hardware, except general call support, while portions of the master protocol need to be addressed in the PIC16CXX software. Table 11-3 defines some of the I²C bus terminology. For additional information on the I²C interface specification, refer to the Philips document “*The I²C bus and how to use it.*” #939839340011, which can be obtained from the Philips Corporation.

In the I²C interface protocol each device has an address. When a master wishes to initiate a data transfer, it first transmits the address of the device that it wishes to “talk” to. All devices “listen” to see if this is their address. Within this address, a bit specifies if the master wishes to read-from/write-to the slave device. The master and slave are always in opposite modes (transmitter/receiver) of operation during a data transfer. That is they can be thought of as operating in either of these two relations:

- Master-transmitter and Slave-receiver
- Slave-transmitter and Master-receiver

In both cases the master generates the clock signal.

The output stages of the clock (SCL) and data (SDA) lines must have an open-drain or open-collector in order to perform the wired-AND function of the bus. External pull-up resistors are used to ensure a high level when no device is pulling the line down. The number of devices that may be attached to the I²C bus is limited only by the maximum bus loading specification of 400 pF.

11.4.1 INITIATING AND TERMINATING DATA TRANSFER

During times of no data transfer (idle time), both the clock line (SCL) and the data line (SDA) are pulled high through the external pull-up resistors. The START and STOP conditions determine the start and stop of data transmission. The START condition is defined as a high to low transition of the SDA when the SCL is high. The STOP condition is defined as a low to high transition of the SDA when the SCL is high. Figure 11-14 shows the START and STOP conditions. The master generates these conditions for starting and terminating data transfer. Due to the definition of the START and STOP conditions, when data is being transmitted, the SDA line can only change state when the SCL line is low.

FIGURE 11-14: START AND STOP CONDITIONS



TABLE 11-3: I²C BUS TERMINOLOGY

Term	Description
Transmitter	The device that sends the data to the bus.
Receiver	The device that receives the data from the bus.
Master	The device which initiates the transfer, generates the clock and terminates the transfer.
Slave	The device addressed by a master.
Multi-master	More than one master device in a system. These masters can attempt to control the bus at the same time without corrupting the message.
Arbitration	Procedure that ensures that only one of the master devices will control the bus. This ensure that the transfer data does not get corrupted.
Synchronization	Procedure where the clock signals of two or more devices are synchronized.

11.4.2 ADDRESSING I²C DEVICES

There are two address formats. The simplest is the 7-bit address format with a R/W bit (Figure 11-15). The more complex is the 10-bit address with a R/W bit (Figure 11-16). For 10-bit address format, two bytes must be transmitted with the first five bits specifying this to be a 10-bit address.

FIGURE 11-15: 7-BIT ADDRESS FORMAT



FIGURE 11-16: I²C 10-BIT ADDRESS FORMAT



11.4.3 TRANSFER ACKNOWLEDGE

All data must be transmitted per byte, with no limit to the number of bytes transmitted per data transfer. After each byte, the slave-receiver generates an acknowledge bit (ACK) (Figure 11-17). When a slave-receiver doesn't acknowledge the slave address or received data, the master must abort the transfer. The slave must leave SDA high so that the master can generate the STOP condition (Figure 11-14).

FIGURE 11-17: SLAVE-RECEIVER ACKNOWLEDGE



If the master is receiving the data (master-receiver), it generates an acknowledge signal for each received byte of data, except for the last byte. To signal the end of data to the slave-transmitter, the master does not generate an acknowledge (not acknowledge). The slave then releases the SDA line so the master can generate the STOP condition. The master can also generate the STOP condition during the acknowledge pulse for valid termination of data transfer.

If the slave needs to delay the transmission of the next byte, holding the SCL line low will force the master into a wait state. Data transfer continues when the slave releases the SCL line. This allows the slave to move the received data or fetch the data it needs to transfer before allowing the clock to start. This wait state technique can also be implemented at the bit level, Figure 11-18. The slave will inherently stretch the clock, when it is a transmitter, but will not when it is a receiver. The slave will have to clear the SSPCON<4> bit to enable clock stretching when it is a receiver.

FIGURE 11-18: DATA TRANSFER WAIT STATE



Figure 11-19 and Figure 11-20 show Master-transmitter and Master-receiver data transfer sequences.

When a master does not wish to relinquish the bus (by generating a STOP condition), a repeated START condition (Sr) must be generated. This condition is identical to the start condition (S) (SDA goes high-to-low while

SCL is high), but occurs after a data transfer acknowledge pulse (not the bus-free state). This allows a master to send "commands" to the slave and then receive the requested information or to address a different slave device. This sequence is shown in Figure 11-21.

FIGURE 11-19: MASTER-TRANSMITTER SEQUENCE



FIGURE 11-20: MASTER-RECEIVER SEQUENCE



FIGURE 11-21: COMBINED FORMAT



11.4.4 MULTI-MASTER

The I²C protocol allows a system to have more than one master. This is called multi-master. When two or more masters try to transfer data at the same time, arbitration and synchronization occur.

11.4.4.1 ARBITRATION

Arbitration takes place on the SDA line, while the SCL line is high. The master which transmits a high when the other master transmits a low loses arbitration (Figure 11-22), and turns off its data output stage. A master which lost arbitration can generate clock pulses until the end of the data byte where it lost arbitration. When the master devices are addressing the same device, arbitration continues into the data.

FIGURE 11-22: MULTI-MASTER ARBITRATION (TWO MASTERS)



Masters that also incorporate the slave function, and have lost arbitration must immediately switch over to slave-receiver mode. This is because the winning master-transmitter may be addressing it.

Arbitration is not allowed between:

- A repeated START condition
- A STOP condition and a data bit
- A repeated START condition and a STOP condition

Care needs to be taken to ensure that these conditions do not occur.

11.2.4.2 Clock Synchronization

Clock synchronization occurs after the devices have started arbitration. This is performed using a wired-AND connection to the SCL line. A high to low transition on the SCL line causes the concerned devices to start counting off their low period. Once a device clock has gone low, it will hold the SCL line low until its SCL high state is reached. The low to high transition of this clock may not change the state of the SCL line, if another device clock is still within its low period. The SCL line is held low by the device with the longest low period. Devices with shorter low periods enter a high wait-state, until the SCL line comes high. When the SCL line comes high, all devices start counting off their high periods. The first device to complete its high period will pull the SCL line low. The SCL line high time is determined by the device with the shortest high period, Figure 11-23.

FIGURE 11-23: CLOCK SYNCHRONIZATION



11.5 SSP I²C Operation

The SSP module in I²C mode fully implements all slave functions, except general call support, and provides interrupts on start and stop bits in hardware to facilitate firmware implementations of the master functions. The SSP module implements the standard mode specifications as well as 7-bit and 10-bit addressing. Two pins are used for data transfer. These are the RC3/SCK/SCL pin, which is the clock (SCL), and the RC4/SDI/SDA pin, which is the data (SDA). The user must configure these pins as inputs or outputs through the TRISC<4:3> bits. The SSP module functions are enabled by setting SSP Enable bit SSPEN (SSPCON<5>).

FIGURE 11-24: SSP BLOCK DIAGRAM (I²C MODE)



The SSP module has five registers for I²C operation. These are the:

- SSP Control Register (SSPCON)
- SSP Status Register (SSPSTAT)
- Serial Receive/Transmit Buffer (SSPBUF)
- SSP Shift Register (SSPSR) - Not directly accessible
- SSP Address Register (SSPADD)

The SSPCON register allows control of the I²C operation. Four mode selection bits (SSPCON<3:0>) allow one of the following I²C modes to be selected:

- I²C Slave mode (7-bit address)
- I²C Slave mode (10-bit address)
- I²C Slave mode (7-bit address), with start and stop bit interrupts enabled
- I²C Slave mode (10-bit address), with start and stop bit interrupts enabled
- I²C Firmware controlled Master Mode, slave is idle

Selection of any I²C mode, with the SSPEN bit set, forces the SCL and SDA pins to be open drain, provided these pins are programmed to inputs by setting the appropriate TRISC bits.

The SSPSTAT register gives the status of the data transfer. This information includes detection of a START or STOP bit, specifies if the received byte was data or address if the next byte is the completion of 10-bit address, and if this will be a read or write data transfer. The SSPSTAT register is read only.

The SSPBUF is the register to which transfer data is written to or read from. The SSPSR register shifts the data in or out of the device. In receive operations, the SSPBUF and SSPSR create a doubled buffered receiver. This allows reception of the next byte to begin before reading the last byte of received data. When the complete byte is received, it is transferred to the SSPBUF register and flag bit SSPIF is set. If another complete byte is received before the SSPBUF register is read, a receiver overflow has occurred and bit SSPOV (SSPCON<6>) is set and the byte in the SSPSR is lost.

The SSPADD register holds the slave address. In 10-bit mode, the user first needs to write the high byte of the address (1111 0 A9 A8 0). Following the high byte address match, the low byte of the address needs to be loaded (A7:A0).

11.5.1 SLAVE MODE

In slave mode, the SCL and SDA pins must be configured as inputs (TRISC<4:3> set). The SSP module will override the input state with the output data when required (slave-transmitter).

When an address is matched or the data transfer after an address match is received, the hardware automatically will generate the acknowledge (ACK) pulse, and then load the SSPBUF register with the received value currently in the SSPSR register.

There are certain conditions that will cause the SSP module not to give this ACK pulse. These are if either (or both):

- a) The buffer full bit BF (SSPSTAT<0>) was set before the transfer was received.
- b) The overflow bit SSPOV (SSPCON<6>) was set before the transfer was received.

In this case, the SSPSR register value is not loaded into the SSPBUF, but bit SSPIF (PIR1<3>) is set. Table 11-4 shows what happens when a data transfer byte is received, given the status of bits BF and SSPOV. The shaded cells show the condition where user software did not properly clear the overflow condition. Flag bit BF is cleared by reading the SSPBUF register while bit SSPOV is cleared through software.

The SCL clock input must have a minimum high and low for proper operation. The high and low times of the I²C specification as well as the requirement of the SSP module is shown in timing parameter #100 and parameter #101.

11.5.1.1 ADDRESSING

Once the SSP module has been enabled, it waits for a START condition to occur. Following the START condition, the 8-bits are shifted into the SSPSR register. All incoming bits are sampled with the rising edge of the clock (SCL) line. The value of register SSPSR<7:1> is compared to the value of the SSPADD register. The

address is compared on the falling edge of the eighth clock (SCL) pulse. If the addresses match, and the BF and SSPOV bits are clear, the following events occur:

- a) The SSPSR register value is loaded into the SSPBUF register.
- b) The buffer full bit, BF is set.
- c) An ACK pulse is generated.
- d) SSP interrupt flag bit, SSPIF (PIR1<3>) is set (interrupt is generated if enabled) - on the falling edge of the ninth SCL pulse.

In 10-bit address mode, two address bytes need to be received by the slave (Figure 11-16). The five Most Significant bits (MSBs) of the first address byte specify if this is a 10-bit address. Bit R/W (SSPSTAT<2>) must specify a write so the slave device will receive the second address byte. For a 10-bit address the first byte would equal '1111 0 A9 A8 0', where A9 and A8 are the two MSBs of the address. The sequence of events for 10-bit address is as follows, with steps 7- 9 for slave-transmitter:

1. Receive first (high) byte of Address (bits SSPIF, BF, and bit UA (SSPSTAT<1>) are set).
2. Update the SSPADD register with second (low) byte of Address (clears bit UA and releases the SCL line).
3. Read the SSPBUF register (clears bit BF) and clear flag bit SSPIF.
4. Receive second (low) byte of Address (bits SSPIF, BF, and UA are set).
5. Update the SSPADD register with the first (high) byte of Address, if match releases SCL line, this will clear bit UA.
6. Read the SSPBUF register (clears bit BF) and clear flag bit SSPIF.
7. Receive repeated START condition.
8. Receive first (high) byte of Address (bits SSPIF and BF are set).
9. Read the SSPBUF register (clears bit BF) and clear flag bit SSPIF.

TABLE 11-4: DATA TRANSFER RECEIVED BYTE ACTIONS

Status Bits as Data Transfer is Received		SSPSR → SSPBUF	Generate ACK Pulse	Set bit SSPIF (SSP Interrupt occurs if enabled)
BF	SSPOV			
0	0	Yes	Yes	Yes
1	0	No	No	Yes
1	1	No	No	Yes
0	1	No	No	Yes

11.5.1.2 RECEPTION

When the $\overline{R/W}$ bit of the address byte is clear and an address match occurs, the $\overline{R/W}$ bit of the SSPSTAT register is cleared. The received address is loaded into the SSPBUF register.

When the address byte overflow condition exists, then no acknowledge (\overline{ACK}) pulse is given. An overflow condition is defined as either bit BF (SSPSTAT<0>) is set or bit SSPOV (SSPCON<6>) is set.

An SSP interrupt is generated for each data transfer byte. Flag bit SSPIF (PIR1<3>) must be cleared in software. The SSPSTAT register is used to determine the status of the byte.

FIGURE 11-25: I²C WAVEFORMS FOR RECEPTION (7-BIT ADDRESS)



11.5.1.3 TRANSMISSION

When the R/\overline{W} bit of the incoming address byte is set and an address match occurs, the R/\overline{W} bit of the SSPSTAT register is set. The received address is loaded into the SSPBUF register. The \overline{ACK} pulse will be sent on the ninth bit, and pin RC3/SCK/SCL is held low. The transmit data must be loaded into the SSPBUF register, which also loads the SSPSR register. Then pin RC3/SCK/SCL should be enabled by setting bit CKP (SSPCON<4>). The master must monitor the SCL pin prior to asserting another clock pulse. The slave devices may be holding off the master by stretching the clock. The eight data bits are shifted out on the falling edge of the SCL input. This ensures that the SDA signal is valid during the SCL high time (Figure 11-26).

An SSP interrupt is generated for each data transfer byte. Flag bit SSPIF must be cleared in software, and the SSPSTAT register is used to determine the status of the byte. Flag bit SSPIF is set on the falling edge of the ninth clock pulse.

As a slave-transmitter, the \overline{ACK} pulse from the master-receiver is latched on the rising edge of the ninth SCL input pulse. If the SDA line was high (not \overline{ACK}), then the data transfer is complete. When the \overline{ACK} is latched by the slave, the slave logic is reset (resets SSPSTAT register) and the slave then monitors for another occurrence of the START bit. If the SDA line was low (\overline{ACK}), the transmit data must be loaded into the SSPBUF register, which also loads the SSPSR register. Then pin RC3/SCK/SCL should be enabled by setting bit CKP.

FIGURE 11-26: I²C WAVEFORMS FOR TRANSMISSION (7-BIT ADDRESS)



11.5.2 MASTER MODE

Master mode of operation is supported in firmware using interrupt generation on the detection of the START and STOP conditions. The STOP (P) and START (S) bits are cleared from a reset or when the SSP module is disabled. The STOP (P) and START (S) bits will toggle based on the START and STOP conditions. Control of the I²C bus may be taken when the P bit is set, or the bus is idle and both the S and P bits are clear.

In master mode the SCL and SDA lines are manipulated by clearing the corresponding TRISC<4:3> bit(s). The output level is always low, irrespective of the value(s) in PORTC<4:3>. So when transmitting data, a '1' data bit must have the TRISC<4> bit set (input) and a '0' data bit must have the TRISC<4> bit cleared (output). The same scenario is true for the SCL line with the TRISC<3> bit.

The following events will cause SSP Interrupt Flag bit, SSPIF, to be set (SSP Interrupt if enabled):

- START condition
- STOP condition
- Data transfer byte transmitted/received

Master mode of operation can be done with either the slave mode idle (SSPM3:SSPM0 = 1011) or with the slave active. When both master and slave modes are enabled, the software needs to differentiate the source(s) of the interrupt.

11.5.3 MULTI-MASTER MODE

In multi-master mode, the interrupt generation on the detection of the START and STOP conditions allows the determination of when the bus is free. The STOP (P) and START (S) bits are cleared from a reset or when the SSP module is disabled. The STOP (P) and START (S) bits will toggle based on the START and STOP conditions. Control of the I²C bus may be taken when bit P (SSPSTAT<4>) is set, or the bus is idle and both the S and P bits clear. When the bus is busy, enabling the SSP Interrupt will generate the interrupt when the STOP condition occurs.

In multi-master operation, the SDA line must be monitored to see if the signal level is the expected output level. This check only needs to be done when a high level is output. If a high level is expected and a low level is present, the device needs to release the SDA and SCL lines (set TRISC<4:3>). There are two stages where this arbitration can be lost, these are:

- Address Transfer
- Data Transfer

When the slave logic is enabled, the slave continues to receive. If arbitration was lost during the address transfer stage, communication to the device may be in progress. If addressed an \overline{ACK} pulse will be generated. If arbitration was lost during the data transfer stage, the device will need to re-transfer the data at a later time.

TABLE 11-5: REGISTERS ASSOCIATED WITH I²C OPERATION

Address	Name	Bit 7	Bit 6	Bit 5	Bit 4	Bit 3	Bit 2	Bit 1	Bit 0	Value on POR, BOR	Value on all other resets
0Bh, 8Bh, 10Bh, 18Bh	INTCON	GIE	PEIE	TOIE	INTE	RBIE	TOIF	INTF	RBFIF	0000 000x	0000 000u
0Ch	PIR1	PSPIF ⁽¹⁾	⁽²⁾	RCIF	TXIF	SSPIF	CCP1IF	TMR2IF	TMR1IF	0000 0000	0000 0000
8Ch	PIE1	PSPIE ⁽¹⁾	⁽²⁾	RCIE	TXIE	SSPIE	CCP1IE	TMR2IE	TMR1IE	0000 0000	0000 0000
13h	SSPBUF	Synchronous Serial Port Receive Buffer/Transmit Register								xxxxx xxxxx	uuuu uuuu
93h	SSPADD	Synchronous Serial Port (I ² C mode) Address Register								0000 0000	0000 0000
14h	SSPCON	WCOL	SSPOV	SSPEN	CKP	SSPM3	SSPM2	SSPM1	SSPM0	0000 0000	0000 0000
94h	SSPSTAT	SMP ⁽³⁾	CKE ⁽³⁾	D/ \overline{A}	P	S	R/ \overline{W}	UA	BF	0000 0000	0000 0000
87h	TRISC	PORTC Data Direction register								1111 1111	1111 1111

Legend: x = unknown, u = unchanged, - = unimplemented locations read as '0'.

Shaded cells are not used by SSP module in SPI mode.

Note 1: PSPIF and PSPIE are reserved on the PIC16C66, always maintain these bits clear.

2: PIR1<6> and PIE1<6> are reserved, always maintain these bits clear.

3: The SMP and CKE bits are implemented on the PIC16C66/67 only. All other PIC16C6X devices have these two bits unimplemented, read as '0'.

FIGURE 11-27: OPERATION OF THE I²C MODULE IN IDLE_MODE, RCV_MODE OR XMIT_MODE

<p>IDLE_MODE (7-bit): if (Addr_match) { Set interrupt; if (R/W = 1) { Send \overline{ACK} = 0; set XMIT_MODE; } } else if (R/W = 0) set RCV_MODE; }</p>
<p>RCV_MODE: if ((SSPBUF=Full) OR (SSPOV = 1)) { Set SSPOV; Do not acknowledge; } else { transfer SSPSR → SSPBUF; send \overline{ACK} = 0; } Receive 8-bits in SSPSR; Set interrupt;</p>
<p>XMIT_MODE: While ((SSPBUF = Empty) AND (CKP=0)) Hold SCL Low; Send byte; Set interrupt; if (\overline{ACK} Received = 1) { End of transmission; Go back to IDLE_MODE; } else if (\overline{ACK} Received = 0) Go back to XMIT_MODE;</p>
<p>IDLE_MODE (10-Bit): If (High_byte_addr_match AND (R/W = 0)) { PRIOR_ADDR_MATCH = FALSE; Set interrupt; if ((SSPBUF = Full) OR ((SSPOV = 1)) { Set SSPOV; Do not acknowledge; } else { Set UA = 1; Send \overline{ACK} = 0; While (SSPADD not updated) Hold SCL low; Clear UA = 0; Receive Low_addr_byte; Set interrupt; Set UA = 1; If (Low_byte_addr_match) { PRIOR_ADDR_MATCH = TRUE; Send \overline{ACK} = 0; while (SSPADD not updated) Hold SCL low; Clear UA = 0; Set RCV_MODE; } } } } else if (High_byte_addr_match AND (R/W = 1)) { if (PRIOR_ADDR_MATCH) { send \overline{ACK} = 0; set XMIT_MODE; } else PRIOR_ADDR_MATCH = FALSE; } }</p>

12.0 UNIVERSAL SYNCHRONOUS ASYNCHRONOUS RECEIVER TRANSMITTER (USART) MODULE

Applicable Devices													
61	62	62A	R62	63	R63	64	64A	R64	65	65A	R65	66	67

The Universal Synchronous Asynchronous Receiver Transmitter (USART) module is one of the two serial I/O modules. (USART is also known as a Serial Communications Interface or SCI) The USART can be configured as a full duplex asynchronous system that can communicate with peripheral devices such as CRT ter-

minals and personal computers, or it can be configured as a half duplex synchronous system that can communicate with peripheral devices such as A/D or D/A integrated circuits, Serial EEPROMs etc.

The USART can be configured in the following modes:

- Asynchronous (full duplex)
- Synchronous - Master (half duplex)
- Synchronous - Slave (half duplex)

Bit SPEN (RCSTA<7>) and bits TRISC<7:6> have to be set in order to configure pins RC6/TX/CK and RC7/RX/DT as the Universal Synchronous Asynchronous Receiver Transmitter.

FIGURE 12-1: TXSTA: TRANSMIT STATUS AND CONTROL REGISTER (ADDRESS 98h)

R/W-0	R/W-0	R/W-0	R/W-0	U-0	R/W-0	R-1	R/W-0	
CSRC	TX9	TXEN	SYNC	—	BRGH	TRMT	TX9D	
bit7								bit0
<div style="border: 1px solid black; padding: 5px; float: right; width: 150px;"> R = Readable bit W = Writable bit U = Unimplemented bit, read as '0' - n =Value at POR reset </div>								
bit 7: CSRC: Clock Source Select bit <u>Asynchronous mode</u> Don't care <u>Synchronous mode</u> 1 = Master mode (Clock generated internally from BRG) 0 = Slave mode (Clock from external source)								
bit 6: TX9: 9-bit Transmit Enable bit 1 = Selects 9-bit transmission 0 = Selects 8-bit transmission								
bit 5: TXEN: Transmit Enable bit 1 = Transmit enabled 0 = Transmit disabled Note: SREN/CREN overrides TXEN in SYNC mode.								
bit 4: SYNC: USART Mode Select bit 1 = Synchronous mode 0 = Asynchronous mode								
bit 3: Unimplemented: Read as '0'								
bit 2: BRGH: High Baud Rate Select bit <u>Asynchronous mode</u> 1 = High speed <div style="border: 1px solid black; padding: 5px; margin-top: 5px;"> Note: For the PIC16C63/R63/65/65A/R65 the asynchronous high speed mode (BRGH = 1) may experience a high rate of receive errors. It is recommended that BRGH = 0. If you desire a higher baud rate than BRGH = 0 can support, refer to the device errata for additional information or use the PIC16C66/67. </div> 0 = Low speed <u>Synchronous mode</u> Unused in this mode								
bit 1: TRMT: Transmit Shift Register Status bit 1 = TSR empty 0 = TSR full								
bit 0: TX9D: 9th bit of transmit data. Can be parity bit.								

PIC16C6X

FIGURE 12-2: RCSTA: RECEIVE STATUS AND CONTROL REGISTER (ADDRESS 18h)

R/W-0	R/W-0	R/W-0	R/W-0	U-0	R-0	R-0	R-x
SPEN	RX9	SREN	CREN	—	FERR	OERR	RX9D
bit7							bit0

R = Readable bit
 W = Writable bit
 U = Unimplemented bit, read as '0'
 - n = Value at POR reset
 x = unknown

bit 7: **SPEN**: Serial Port Enable bit
 (Configures RC7/RX/DT and RC6/TX/CK pins as serial port pins when bits TRISC<7:6> are set)
 1 = Serial port enabled
 0 = Serial port disabled

bit 6: **RX9**: 9-bit Receive Enable bit
 1 = Selects 9-bit reception
 0 = Selects 8-bit reception

bit 5: **SREN**: Single Receive Enable bit
Asynchronous mode
 Don't care

Synchronous mode - master
 1 = Enables single receive
 0 = Disables single receive
 This bit is cleared after reception is complete.

Synchronous mode - slave
 Unused in this mode

bit 4: **CREN**: Continuous Receive Enable bit
Asynchronous mode
 1 = Enables continuous receive
 0 = Disables continuous receive

Synchronous mode
 1 = Enables continuous receive until enable bit CREN is cleared (CREN overrides SREN)
 0 = Disables continuous receive

bit 3: **Unimplemented**: Read as '0'

bit 2: **FERR**: Framing Error bit
 1 = Framing error (Can be updated by reading RCREG register and receive next valid byte)
 0 = No framing error

bit 1: **OERR**: Overrun Error bit
 1 = Overrun error (Can be cleared by clearing bit CREN)
 0 = No overrun error

bit 0: **RX9D**: 9th bit of received data (Can be parity bit)

12.1 USART Baud Rate Generator (BRG)

Applicable Devices

61	62	62A	R62	63	R63	64	64A	R64	65	65A	R65	66	67
----	----	-----	-----	----	-----	----	-----	-----	----	-----	-----	----	----

The BRG supports both the Asynchronous and Synchronous modes of the USART. It is a dedicated 8-bit baud rate generator. The SPBRG register controls the period of a free running 8-bit timer. In asynchronous mode bit BRGH (TXSTA<2>) also controls the baud rate. In synchronous mode bit BRGH is ignored. Table 12-1 shows the formula for computation of the baud rate for different USART modes which only apply in master mode (internal clock).

Given the desired baud rate and F_{osc} , the nearest integer value for the SPBRG register can be calculated using the formula in Table 12-1. From this, the error in baud rate can be determined.

Example 12-1 shows the calculation of the baud rate error for the following conditions:

$F_{osc} = 16$ MHz
 Desired Baud Rate = 9600
 BRGH = 0
 SYNC = 0

EXAMPLE 12-1: CALCULATING BAUD RATE ERROR

$$\begin{aligned} \text{Desired Baud rate} &= F_{osc} / (64 (X + 1)) \\ 9600 &= 16000000 / (64 (X + 1)) \\ X &= \lfloor 25.042 \rfloor = 25 \\ \text{Calculated Baud Rate} &= 16000000 / (64 (25 + 1)) \\ &= 9615 \\ \text{Error} &= \frac{(\text{Calculated Baud Rate} - \text{Desired Baud Rate})}{\text{Desired Baud Rate}} \\ &= (9615 - 9600) / 9600 \\ &= 0.16\% \end{aligned}$$

It may be advantageous to use the high baud rate (BRGH = 1) even for slower baud clocks. This is because the $F_{osc}/(16(X + 1))$ equation can reduce the baud rate error in some cases.

Note: For the PIC16C63/R63/65/65A/R65 the asynchronous high speed mode (BRGH = 1) may experience a high rate of receive errors. It is recommended that BRGH = 0. If you desire a higher baud rate than BRGH = 0 can support, refer to the device errata for additional information or use the PIC16C66/67.

Writing a new value to the SPBRG register, causes the BRG timer to be reset (or cleared), this ensures that the BRG does not wait for a timer overflow before outputting the new baud rate.

TABLE 12-1: BAUD RATE FORMULA

SYNC	BRGH = 0 (Low Speed)	BRGH = 1 (High Speed)
0	(Asynchronous) Baud Rate = $F_{osc}/(64(X+1))$	Baud Rate = $F_{osc}/(16(X+1))$
1	(Synchronous) Baud Rate = $F_{osc}/(4(X+1))$	N/A

X = value in SPBRG (0 to 255)

TABLE 12-2: REGISTERS ASSOCIATED WITH BAUD RATE GENERATOR

Address	Name	Bit 7	Bit 6	Bit 5	Bit 4	Bit 3	Bit 2	Bit 1	Bit 0	Value on POR, BOR	Value on all other Resets
98h	TXSTA	CSRC	TX9	TXEN	SYNC	—	BRGH	TRMT	TX9D	0000 -010	0000 -010
18h	RCSTA	SPEN	RX9	SREN	CREN	—	FERR	OERR	RX9D	0000 -00x	0000 -00x
99h	SPBRG	Baud Rate Generator Register								0000 0000	0000 0000

Legend: x = unknown, - = unimplemented read as '0'. Shaded cells are not used by the BRG.

PIC16C6X

TABLE 12-3: BAUD RATES FOR SYNCHRONOUS MODE

BAUD RATE (K)	FOSC = 20 MHz			16 MHz			10 MHz			7.15909 MHz		
	KBAUD	% ERROR	SPBRG value (decimal)	KBAUD	% ERROR	SPBRG value (decimal)	KBAUD	% ERROR	SPBRG value (decimal)	KBAUD	% ERROR	SPBRG value (decimal)
0.3	NA	-	-	NA	-	-	NA	-	-	NA	-	-
1.2	NA	-	-	NA	-	-	NA	-	-	NA	-	-
2.4	NA	-	-	NA	-	-	NA	-	-	NA	-	-
9.6	NA	-	-	NA	-	-	9.766	+1.73	255	9.622	+0.23	185
19.2	19.53	+1.73	255	19.23	+0.16	207	19.23	+0.16	129	19.24	+0.23	92
76.8	76.92	+0.16	64	76.92	+0.16	51	75.76	-1.36	32	77.82	+1.32	22
96	96.15	+0.16	51	95.24	-0.79	41	96.15	+0.16	25	94.20	-1.88	18
300	294.1	-1.96	16	307.69	+2.56	12	312.5	+4.17	7	298.3	-0.57	5
500	500	0	9	500	0	7	500	0	4	NA	-	-
HIGH	5000	-	0	4000	-	0	2500	-	0	1789.8	-	0
LOW	19.53	-	255	15.625	-	255	9.766	-	255	6.991	-	255

BAUD RATE (K)	FOSC = 5.0688 MHz			4 MHz			3.579545 MHz			1 MHz			32.768 kHz		
	KBAUD	% ERROR	SPBRG value (decimal)	KBAUD	% ERROR	SPBRG value (decimal)	KBAUD	% ERROR	SPBRG value (decimal)	KBAUD	% ERROR	SPBRG value (decimal)	KBAUD	% ERROR	SPBRG value (decimal)
0.3	NA	-	-	NA	-	-	NA	-	-	NA	-	-	0.303	+1.14	26
1.2	NA	-	-	NA	-	-	NA	-	-	1.202	+0.16	207	1.170	-2.48	6
2.4	NA	-	-	NA	-	-	NA	-	-	2.404	+0.16	103	NA	-	-
9.6	9.6	0	131	9.615	+0.16	103	9.622	+0.23	92	9.615	+0.16	25	NA	-	-
19.2	19.2	0	65	19.231	+0.16	51	19.04	-0.83	46	19.24	+0.16	12	NA	-	-
76.8	79.2	+3.13	15	76.923	+0.16	12	74.57	-2.90	11	83.34	+8.51	2	NA	-	-
96	97.48	+1.54	12	1000	+4.17	9	99.43	+3.57	8	NA	-	-	NA	-	-
300	316.8	+5.60	3	NA	-	-	298.3	-0.57	2	NA	-	-	NA	-	-
500	NA	-	-	NA	-	-	NA	-	-	NA	-	-	NA	-	-
HIGH	1267	-	0	100	-	0	894.9	-	0	250	-	0	8.192	-	0
LOW	4.950	-	255	3.906	-	255	3.496	-	255	0.9766	-	255	0.032	-	255

TABLE 12-4: BAUD RATES FOR ASYNCHRONOUS MODE (BRGH = 0)

BAUD RATE (K)	FOSC = 20 MHz			16 MHz			10 MHz			7.15909 MHz		
	KBAUD	% ERROR	SPBRG value (decimal)	KBAUD	% ERROR	SPBRG value (decimal)	KBAUD	% ERROR	SPBRG value (decimal)	KBAUD	% ERROR	SPBRG value (decimal)
0.3	NA	-	-	NA	-	-	NA	-	-	NA	-	-
1.2	1.221	+1.73	255	1.202	+0.16	207	1.202	+0.16	129	1.203	+0.23	92
2.4	2.404	+0.16	129	2.404	+0.16	103	2.404	+0.16	64	2.380	-0.83	46
9.6	9.469	-1.36	32	9.615	+0.16	25	9.766	+1.73	15	9.322	-2.90	11
19.2	19.53	+1.73	15	19.23	+0.16	12	19.53	+1.73	7	18.64	-2.90	5
76.8	78.13	+1.73	3	83.33	+8.51	2	78.13	+1.73	1	NA	-	-
96	104.2	+8.51	2	NA	-	-	NA	-	-	NA	-	-
300	312.5	+4.17	0	NA	-	-	NA	-	-	NA	-	-
500	NA	-	-	NA	-	-	NA	-	-	NA	-	-
HIGH	312.5	-	0	250	-	0	156.3	-	0	111.9	-	0
LOW	1.221	-	255	0.977	-	255	0.6104	-	255	0.437	-	255

BAUD RATE (K)	FOSC = 5.0688 MHz			4 MHz			3.579545 MHz			1 MHz			32.768 kHz		
	KBAUD	% ERROR	SPBRG value (decimal)	KBAUD	% ERROR	SPBRG value (decimal)	KBAUD	% ERROR	SPBRG value (decimal)	KBAUD	% ERROR	SPBRG value (decimal)	KBAUD	% ERROR	SPBRG value (decimal)
0.3	0.31	+3.13	255	0.3005	-0.17	207	0.301	+0.23	185	0.300	+0.16	51	0.256	-14.67	1
1.2	1.2	0	65	1.202	+1.67	51	1.190	-0.83	46	1.202	+0.16	12	NA	-	-
2.4	2.4	0	32	2.404	+1.67	25	2.432	+1.32	22	2.232	-6.99	6	NA	-	-
9.6	9.9	+3.13	7	NA	-	-	9.322	-2.90	5	NA	-	-	NA	-	-
19.2	19.8	+3.13	3	NA	-	-	18.64	-2.90	2	NA	-	-	NA	-	-
76.8	79.2	+3.13	0	NA	-	-	NA	-	-	NA	-	-	NA	-	-
96	NA	-	-	NA	-	-	NA	-	-	NA	-	-	NA	-	-
300	NA	-	-	NA	-	-	NA	-	-	NA	-	-	NA	-	-
500	NA	-	-	NA	-	-	NA	-	-	NA	-	-	NA	-	-
HIGH	79.2	-	0	62.500	-	0	55.93	-	0	15.63	-	0	0.512	-	0
LOW	0.3094	-	255	3.906	-	255	0.2185	-	255	0.0610	-	255	0.0020	-	255

TABLE 12-5: BAUD RATES FOR ASYNCHRONOUS MODE (BRGH = 1)

BAUD RATE (K)	FOSC = 20 MHz			16 MHz			10 MHz			7.16 MHz		
	KBAUD	% ERROR	SPBRG value (decimal)	KBAUD	% ERROR	SPBRG value (decimal)	KBAUD	% ERROR	SPBRG value (decimal)	KBAUD	% ERROR	SPBRG value (decimal)
9.6	9.615	+0.16	129	9.615	+0.16	103	9.615	+0.16	64	9.520	-0.83	46
19.2	19.230	+0.16	64	19.230	+0.16	51	18.939	-1.36	32	19.454	+1.32	22
38.4	37.878	-1.36	32	38.461	+0.16	25	39.062	+1.7	15	37.286	-2.90	11
57.6	56.818	-1.36	21	58.823	+2.12	16	56.818	-1.36	10	55.930	-2.90	7
115.2	113.636	-1.36	10	111.111	-3.55	8	125	+8.51	4	111.860	-2.90	3
250	250	0	4	250	0	3	NA	-	-	NA	-	-
625	625	0	1	NA	-	-	625	0	0	NA	-	-
1250	1250	0	0	NA	-	-	NA	-	-	NA	-	-

BAUD RATE (K)	FOSC = 5.068 MHz			4 MHz			3.579 MHz			1 MHz			32.768 kHz		
	KBAUD	% ERROR	SPBRG value (decimal)	KBAUD	% ERROR	SPBRG value (decimal)	KBAUD	% ERROR	SPBRG value (decimal)	KBAUD	% ERROR	SPBRG value (decimal)	KBAUD	% ERROR	SPBRG value (decimal)
9.6	9.6	0	32	NA	-	-	9.727	+1.32	22	8.928	-6.99	6	NA	-	-
19.2	18.645	-2.94	16	1.202	+0.17	207	18.643	-2.90	11	20.833	+8.51	2	NA	-	-
38.4	39.6	+3.12	7	2.403	+0.13	103	37.286	-2.90	5	31.25	-18.61	1	NA	-	-
57.6	52.8	-8.33	5	9.615	+0.16	25	55.930	-2.90	3	62.5	+8.51	0	NA	-	-
115.2	105.6	-8.33	2	19.231	+0.16	12	111.860	-2.90	1	NA	-	-	NA	-	-
250	NA	-	-	NA	-	-	223.721	-10.51	0	NA	-	-	NA	-	-
625	NA	-	-	NA	-	-	NA	-	-	NA	-	-	NA	-	-
1250	NA	-	-	NA	-	-	NA	-	-	NA	-	-	NA	-	-

Note: For the PIC16C63/R63/65/65A/R65 the asynchronous high speed mode (BRGH = 1) may experience a high rate of receive errors. It is recommended that BRGH = 0. If you desire a higher baud rate than BRGH = 0 can support, refer to the device errata for additional information or use the PIC16C66/67.

PIC16C6X

12.1.1 SAMPLING

The data on the RC7/RX/DT pin is sampled three times by a majority detect circuit to determine if a high or a low level is present at the RX pin. If bit BRGH (TXSTA<2>) is clear (i.e., at the low baud rates), the sampling is done on the seventh, eighth and ninth falling edges of a x16 clock (Figure 12-3). If bit BRGH is

set (i.e., at the high baud rates), the sampling is done on the 3 clock edges preceding the second rising edge after the first falling edge of a x4 clock (Figure 12-4 and Figure 12-5).

FIGURE 12-3: RX PIN SAMPLING SCHEME (BRGH = 0) (PIC16C63/R63/65/65A/R65)



FIGURE 12-4: RX PIN SAMPLING SCHEME (BRGH = 1) (PIC16C63/R63/65/65A/R65)



FIGURE 12-5: RX PIN SAMPLING SCHEME (BRGH = 1) (PIC16C63/R63/65/65A/R65)



FIGURE 12-6: RX PIN SAMPLING SCHEME (BRGH = 0 OR = 1) (PIC16C66/67)



PIC16C6X

12.2 USART Asynchronous Mode

Applicable Devices													
61	62	62A	R62	63	R63	64	64A	R64	65	65A	R65	66	67

In this mode, the USART uses standard nonreturn-to-zero (NRZ) format (one start bit, eight or nine data bits and one stop bit). The most common data format is 8-bits. An on-chip dedicated 8-bit baud rate generator can be used to derive standard baud rate frequencies from the oscillator. The USART transmits and receives the Lsb first. The USART's transmitter and receiver are functionally independent but use the same data format and baud rate. The baud rate generator produces a clock either x16 or x64 of the bit shift rate, depending on bit BRGH (TXSTA<2>). Parity is not supported by the hardware, but can be implemented in software (and stored as the ninth data bit). Asynchronous mode is stopped during SLEEP.

Asynchronous mode is selected by clearing bit SYNC (TXSTA<4>).

The USART Asynchronous module consists of the following important elements:

- Baud Rate Generator
- Sampling Circuit
- Asynchronous Transmitter
- Asynchronous Receiver

12.2.1 USART ASYNCHRONOUS TRANSMITTER

The USART transmitter block diagram is shown in Figure 12-7. The heart of the transmitter is the transmit (serial) shift register (TSR). The shift register obtains its data from the read/write transmit buffer, TXREG. The TXREG register is loaded with data in software. The TSR register is not loaded until the STOP bit has been transmitted from the previous load. As soon as the STOP bit is transmitted, the TSR is loaded with new data from the TXREG (if available). Once the TXREG register transfers the data to the TSR register (occurs in one Tcy) the TXREG register is empty and flag bit TXIF (PIR1<4>) is set. This interrupt is enabled/dis-

abled by setting/clearing enable bit TXIE (PIE1<4>). Flag bit TXIF will be set regardless of the state of enable bit TXIE and cannot be cleared in software. It will reset only when new data is loaded into the TXREG register. While flag bit TXIF indicates the status of the TXREG register, another bit, TRMT (TXSTA<1>) shows the status of the TSR register. Status bit TRMT is a read only bit which is set when the TSR register is empty. No interrupt logic is tied to this bit, so the user has to poll this bit in order to determine if the TSR register is empty.

Note 1: The TSR register is not mapped in data memory so it is not available to the user.

Note 2: Flag bit TXIF is set when enable bit TXEN is set.

Transmission is enabled by setting enable bit TXEN (TXSTA<5>). The actual transmission will not occur until the TXREG register has been loaded with data and the baud rate generator (BRG) has produced a shift clock (Figure 12-7). The transmission can also be started by first loading the TXREG register and then setting enable bit TXEN. Normally when transmission is first started, the TSR register is empty, so a transfer to the TXREG register will result in an immediate transfer to TSR register resulting in an empty TXREG register. A back-to-back transfer is thus possible (Figure 12-9). Clearing enable bit TXEN during a transmission will cause the transmission to be aborted and will reset the transmitter. As a result the RC6/TX/CK pin will revert to hi-impedance.

In order to select 9-bit transmission, transmit bit TX9 (TXSTA<6>) should be set and the ninth bit should be written to bit TX9D (TXSTA<0>). The ninth bit must be written before writing the 8-bit data to the TXREG register. This is because a data write to the TXREG register can result in an immediate transfer of the data to the TSR register (if the TSR is empty). In such a case, an incorrect ninth data bit maybe loaded in the TSR register.

FIGURE 12-7: USART TRANSMIT BLOCK DIAGRAM



Steps to follow when setting up an Asynchronous Transmission:

1. Initialize the SPBRG register for the appropriate baud rate. If a high speed baud rate is desired, then set bit BRGH. (Section 12.1).
2. Enable the asynchronous serial port by clearing bit SYNC and setting bit SPEN.
3. If interrupts are desired, then set enable bit TXIE.
4. If 9-bit transmission is desired, then set transmit bit TX9.
5. Enable the transmission by setting bit TXEN, which will also set bit TXIF.
6. If 9-bit transmission is selected, the ninth bit should be loaded in bit TX9D.
7. Load data to the TXREG register (starts transmission).

FIGURE 12-8: ASYNCHRONOUS MASTER TRANSMISSION



FIGURE 12-9: ASYNCHRONOUS MASTER TRANSMISSION (BACK TO BACK)



TABLE 12-6: REGISTERS ASSOCIATED WITH ASYNCHRONOUS TRANSMISSION

Address	Name	Bit 7	Bit 6	Bit 5	Bit 4	Bit 3	Bit 2	Bit 1	Bit 0	Value on POR, BOR	Value on all other Resets
0Ch	PIR1	PSPIF ⁽¹⁾	(2)	RCIF	TXIF	SSPIF	CCP1IF	TMR2IF	TMR1IF	0000 0000	0000 0000
18h	RCSTA	SPEN	RX9	SREN	CREN	—	FERR	OERR	RX9D	0000 -00x	0000 -00x
19h	TXREG	USART Transmit Register								0000 0000	0000 0000
8Ch	PIE1	PSPIE ⁽¹⁾	(2)	RCIE	TXIE	SSPIE	CCP1IE	TMR2IE	TMR1IE	0000 0000	0000 0000
98h	TXSTA	CSRC	TX9	TXEN	SYNC	—	BRGH	TRMT	TX9D	0000 -010	0000 -010
99h	SPBRG	Baud Rate Generator Register								0000 0000	0000 0000

Legend: x = unknown, - = unimplemented locations read as '0'. Shaded cells are not used for Asynchronous Transmission.

Note 1: PSPIF and PSPIE are reserved on the PIC16C63/R63/66, always maintain these bits clear.

2: PIR1<6> and PIE1<6> are reserved, always maintain these bits clear.

PIC16C6X

12.2.2 USART ASYNCHRONOUS RECEIVER

The receiver block diagram is shown in Figure 12-10. The data comes in the RC7/RX/DT pin and drives the data recovery block. The data recovery block is actually a high speed shifter operating at x16 times the baud rate, whereas the main receive serial shifter operates at the bit rate or at Fosc.

Once Asynchronous mode is selected, reception is enabled by setting bit CREN (RCSTA<4>).

The heart of the receiver is the receive (serial) shift register (RSR). After sampling the STOP bit, the received data in the RSR is transferred to the RCREG register (if it is empty). If the transfer is complete, flag bit RCIF (PIR1<5>) is set. The actual interrupt can be enabled/disabled by setting/clearing enable bit RCIE (PIE1<5>). Flag bit RCIF is a read only bit which is cleared by the hardware. It is cleared when the RCREG register has been read and is empty. The RCREG register is double buffered register, i.e., it is a two deep FIFO. It is

possible for two bytes of data to be received and transferred to the RCREG FIFO and a third byte begin shifting to the RSR register. On the detection of the STOP bit of the third byte, if the RCREG is still full, then the overrun error bit, OERR (RCSTA<1>) will be set. The word in the RSR register will be lost. The RCREG register can be read twice to retrieve the two bytes in the FIFO. Overrun bit OERR has to be cleared in software. This is done by resetting the receive logic (CREN is cleared and then set). If bit OERR is set, transfers from the RSR register to the RCREG register are inhibited, so it is essential to clear overrun bit OERR if it is set. Framing error bit FERR (RCSTA<2>) is set if a stop bit is detected as clear. Error bit FERR and the 9th receive bit are buffered the same way as the receive data. Reading the RCREG register will load bits RX9D and FERR with new values. Therefore it is essential for the user to read the RCSTA register before reading RCREG in order not to lose the old FERR and RX9D information.

FIGURE 12-10: USART RECEIVE BLOCK DIAGRAM



FIGURE 12-11: ASYNCHRONOUS RECEPTION



Steps to follow when setting up an Asynchronous Reception:

1. Initialize the SPBRG register for the appropriate baud rate. If a high speed baud rate is desired, set bit BRGH (Section 12.1).
2. Enable the asynchronous serial port by clearing bit SYNC and setting bit SPEN.
3. If interrupts are desired, then set enable bit RCIE.
4. If 9-bit reception is desired, then set bit RX9.
5. Enable the reception by setting enable bit CREN.
6. Flag bit RCIF will be set when reception is complete, and an interrupt will be generated if enable bit RCIE was set.
7. Read the RCSTA register to get the ninth bit (if enabled) and determine if any error occurred during reception.
8. Read the 8-bit received data by reading the RCREG register.
9. If any error occurred, clear the error by clearing enable bit CREN.

TABLE 12-7: REGISTERS ASSOCIATED WITH ASYNCHRONOUS RECEPTION

Address	Name	Bit 7	Bit 6	Bit 5	Bit 4	Bit 3	Bit 2	Bit 1	Bit 0	Value on POR, BOR	Value on all other Resets
0Ch	PIR1	PSPIF ⁽¹⁾	(2)	RCIF	TXIF	SSPIF	CCP1IF	TMR2IF	TMR1IF	0000 0000	0000 0000
18h	RCSTA	SPEN	RX9	SREN	CREN	—	FERR	OERR	RX9D	0000 -00x	0000 -00x
1Ah	RCREG	USART Receive Register								0000 0000	0000 0000
8Ch	PIE1	PSPIE ⁽¹⁾	(2)	RCIE	TXIE	SSPIE	CCP1IE	TMR2IE	TMR1IE	0000 0000	0000 0000
98h	TXSTA	CSRC	TX9	TXEN	SYNC	—	BRGH	TRMT	TX9D	0000 -010	0000 -010
99h	SPBRG	Baud Rate Generator Register								0000 0000	0000 0000

Legend: x = unknown, - = unimplemented locations read as '0'. Shaded cells are not used for Asynchronous Reception.

Note 1: PSPIE and PSPIF are reserved on the PIC16C63/R63/66, always maintain these bits clear.

2: PIE1<6> and PIR1<6> are reserved, always maintain these bits clear.

PIC16C6X

12.3 USART Synchronous Master Mode

Applicable Devices

61	62	62A	R62	63	R63	64	64A	R64	65	65A	R65	66	67
----	----	-----	-----	----	-----	----	-----	-----	----	-----	-----	----	----

In Synchronous Master mode the data is transmitted in a half-duplex manner i.e., transmission and reception do not occur at the same time. When transmitting data the reception is inhibited and vice versa. Synchronous mode is entered by setting bit SYNC (TXSTA<4>). In addition enable bit SPEN (RCSTA<7>) is set in order to configure the RC6 and RC7 I/O pins to CK (clock) and DT (data) lines respectively. The Master mode indicates that the processor transmits the master clock on the CK line. The Master mode is entered by setting bit CSRC (TXSTA<7>).

12.3.1 USART SYNCHRONOUS MASTER TRANSMISSION

The USART transmitter block diagram is shown in Figure 12-7. The heart of the transmitter is the transmit (serial) shift register (TSR). The shift register obtains its data from the read/write transmit buffer register, TXREG. The TXREG register is loaded with data in software. The TSR register is not loaded until the last bit has been transmitted from the previous load. As soon as the last bit is transmitted, the TSR register is loaded with new data from the TXREG register (if available). Once the TXREG register transfers the data to the TSR register (occurs in one Tcycle), the TXREG register is empty and interrupt flag bit TXIF (PIR1<4>) is set. This interrupt can be enabled/disabled by setting/clearing enable bit TXIE (PIE1<4>). Flag bit TXIF will be set regardless of the status of enable bit TXIE and cannot be cleared in software. It will clear only when new data is loaded into the TXREG register. While flag bit TXIF indicates the status of the TXREG register, another bit, TRMT (TXSTA<1>), shows the status of the TSR register. Status bit TRMT is a read only bit which is set when the TSR register is empty. No interrupt logic is tied to this bit, so the user has to poll this bit in order to determine if the TSR register is empty. The TSR register is not mapped in data memory so it is not available to the user.

Transmission is enabled by setting enable bit TXEN (TXSTA<5>). The actual transmission will not occur until the TXREG register has been loaded with data. The first data bit will be shifted out on the next available rising edge of the clock on the CK line. Data out is stable around the falling edge of the synchronous clock (Figure 12-12). The transmission can also be started by first loading the TXREG register and then setting enable bit TXEN (Figure 12-13). This is advantageous when slow baud rates are selected, since the BRG is kept in reset when bits TXEN, CREN, and SREN are clear. Setting enable bit TXEN will start the BRG, creating a shift clock immediately. Normally when transmission is first started, the TSR register is empty, so a transfer to the TXREG register will result in an immediate transfer to TSR resulting in an empty TXREG register. Back-to-back transfers are possible.

Clearing enable bit TXEN, during a transmission, will cause the transmission to be aborted and will reset the transmitter. The DT and CK pins will revert to hi-impedance. If, during a transmission, either bit CREN or bit SREN is set the transmission is aborted and the DT pin reverts to a hi-impedance state (for a reception). The CK pin will remain an output if bit CSRC is set (internal clock). The transmitter logic however, is not reset although it is disconnected from the pins. In order to reset the transmitter, the user has to clear enable bit TXEN. If enable bit SREN is set (to interrupt an on going transmission and receive a single word), then after the single word is received, enable bit SREN will be cleared, and the serial port will revert back to transmitting since enable bit TXEN is still set. The DT line will immediately switch from hi-impedance receive mode to transmit and start driving. To avoid this, enable bit TXEN should be cleared.

In order to select 9-bit transmission, bit TX9 (TXSTA<6>) should be set and the ninth bit should be written to bit TX9D (TXSTA<0>). The ninth bit must be written before writing the 8-bit data to the TXREG register. This is because a data write to the TXREG register can result in an immediate transfer of the data to the TSR register (if the TSR is empty). If the TSR register was empty and the TXREG register was written before writing the "new" TX9D, the "present" value of bit TX9D is loaded.

Steps to follow when setting up a Synchronous Master Transmission:

1. Initialize the SPBRG register for the appropriate baud rate (Section 12.1).
2. Enable the synchronous master serial port by setting bits SYNC, SPEN, and CSRC.
3. If interrupts are desired, then set enable bit TXIE.
4. If 9-bit transmission is desired, then set bit TX9.
5. Enable the transmission by setting enable bit TXEN.
6. If 9-bit transmission is selected, the ninth bit should be loaded in bit TX9D.
7. Start transmission by loading data to the TXREG register.

TABLE 12-8: REGISTERS ASSOCIATED WITH SYNCHRONOUS MASTER TRANSMISSION

Address	Name	Bit 7	Bit 6	Bit 5	Bit 4	Bit 3	Bit 2	Bit 1	Bit 0	Value on POR, BOR	Value on all other Resets
0Ch	PIR1	PSPIF ⁽¹⁾	(2)	RCIF	TXIF	SSPIF	CCP1IF	TMR2IF	TMR1IF	0000 0000	0000 0000
18h	RCSTA	SPEN	RX9	SREN	CREN	—	FERR	OERR	RX9D	0000 -00x	0000 -00x
19h	TXREG	USART Transmit Register								0000 0000	0000 0000
8Ch	PIE1	PSPIE ⁽¹⁾	(2)	RCIE	TXIE	SSPIE	CCP1IE	TMR2IE	TMR1IE	0000 0000	0000 0000
98h	TXSTA	CSRC	TX9	TXEN	SYNC	—	BRGH	TRMT	TX9D	0000 -010	0000 -010
99h	SPBRG	Baud Rate Generator Register								0000 0000	0000 0000

Legend: x = unknown, - = unimplemented locations read as '0'. Shaded cells are not used for Synchronous Master Transmission.

Note 1: PSPIE and PSPIF are reserved on the PIC16C63/R63/66, always maintain these bits clear.

Note 2: PIE1<6> and PIR1<6> are reserved, always maintain these bits clear.

FIGURE 12-12: SYNCHRONOUS TRANSMISSION



FIGURE 12-13: SYNCHRONOUS TRANSMISSION THROUGH TXEN



PIC16C6X

12.3.2 USART SYNCHRONOUS MASTER RECEPTION

Once Synchronous Mode is selected, reception is enabled by setting either enable bit SREN (RCSTA<5>) bit or enable bit CREN (RCSTA<4>). Data is sampled on the DT pin on the falling edge of the clock. If enable bit SREN is set, then only a single word is received. If enable bit CREN is set, the reception is continuous until bit CREN is cleared. If both the bits are set then bit CREN takes precedence. After clocking the last bit, the received data in the Receive Shift Register (RSR) is transferred to the RCREG register (if it is empty). When the transfer is complete, interrupt bit RCIF (PIR1<5>) is set. The actual interrupt can be enabled/disabled by setting/clearing enable bit RCIE (PIE1<5>). Flag bit RCIF is a read only bit which is reset by the hardware. In this case, it is reset when the RCREG register has been read and is empty. The RCREG is a double buffered register, i.e., it is a two deep FIFO. It is possible for two bytes of data to be received and transferred to the RCREG FIFO and a third byte to begin shifting into the RSR register. On the clocking of the last bit of the third byte, if the RCREG register is still full, then overrun error bit, OERR (RCSTA<1>) is set. The word in the RSR register will be lost. The RCREG register can be read twice to retrieve the two bytes in the FIFO. Overrun error bit OERR has to be cleared in software (by clearing bit CREN). If bit OERR is set, transfers from the RSR to the RCREG are inhibited, so it is essential to clear bit OERR if it is set. The 9th receive bit is buffered the same way as the receive data. Reading the RCREG register will load bit RX9D with a new value. Therefore it is essential for the user to read the RCSTA register before reading the RCREG register in order not to lose the old RX9D bit information.

Steps to follow when setting up Synchronous Master Reception:

1. Initialize the SPBRG register for the appropriate baud rate (Section 12.1).
2. Enable the synchronous master serial port by setting bits SYNC, SPEN, and CSRC.
3. Ensure bits CREN and SREN are clear.
4. If interrupts are desired, then set enable bit RCIE.
5. If 9-bit reception is desired, then set bit RX9.
6. If a single reception is required, set enable bit SREN. For continuous reception set enable bit CREN.
7. Flag bit RCIF will be set when reception is complete and an interrupt will be generated if enable bit RCIE was set.
8. Read the RCSTA register to get the ninth bit (if enabled) and determine if any error occurred during reception.
9. Read the 8-bit received data by reading the RCREG register.
10. If any error occurred, clear the error by clearing enable bit CREN.

TABLE 12-9: REGISTERS ASSOCIATED WITH SYNCHRONOUS MASTER RECEPTION

Address	Name	Bit 7	Bit 6	Bit 5	Bit 4	Bit 3	Bit 2	Bit 1	Bit 0	Value on POR, BOR	Value on all other Resets
0Ch	PIR1	PSPIF ⁽¹⁾	(2)	RCIF	TXIF	SSPIF	CCP1IF	TMR2IF	TMR1IF	0000 0000	0000 0000
18h	RCSTA	SPEN	RX9	SREN	CREN	—	FERR	OERR	RX9D	0000 -00x	0000 -00x
1Ah	RCREG	USART Receive Register								0000 0000	0000 0000
8Ch	PIE1	PSPIE ⁽¹⁾	(2)	RCIE	TXIE	SSPIE	CCP1IE	TMR2IE	TMR1IE	0000 0000	0000 0000
98h	TXSTA	CSRC	TX9	TXEN	SYNC	—	BRGH	TRMT	TX9D	0000 -010	0000 -010
99h	SPBRG	Baud Rate Generator Register								0000 0000	0000 0000

Legend: x = unknown, - = unimplemented locations read as '0'. Shaded cells are not used for Synchronous Master Reception.

Note 1: PSPIF and PSPIE are reserved on the PIC16C63/R63/66, always maintain these bits clear.

2: PIR1<6> and PIE1<6> are reserved, always maintain these bits clear.

FIGURE 12-14: SYNCHRONOUS RECEPTION (MASTER MODE, SREN)



PIC16C6X

12.4 USART Synchronous Slave Mode

Applicable Devices

61	62	62A	R62	63	R63	64	64A	R64	65	65A	R65	66	67
----	----	-----	-----	----	-----	----	-----	-----	----	-----	-----	----	----

Synchronous Slave Mode differs from Master Mode in the fact that the shift clock is supplied externally at the CK pin (instead of being supplied internally in master mode). This allows the device to transfer or receive data while in SLEEP mode. Slave mode is entered by clearing bit CSRC (TXSTA<7>).

12.4.1 USART SYNCHRONOUS SLAVE TRANSMIT

The operation of the synchronous master and slave modes are identical except in the case of the SLEEP mode.

If two words are written to the TXREG and then the SLEEP instruction is executed, the following will occur:

- The first word will immediately transfer to the TSR register and transmit.
- The second word will remain in TXREG register.
- Flag bit TXIF will not be set.
- When the first word has been shifted out of TSR, the TXREG register will transfer the second word to the TSR and flag bit TXIF will now be set.
- If enable bit TXIE is set, the interrupt will wake the chip from SLEEP and if the global interrupt is enabled, the program will branch to the interrupt vector (0004h).

Steps to follow when setting up Synchronous Slave Transmission:

- Enable the synchronous slave serial port by setting bits SYNC and SPEN, and clearing bit CSRC.
- Clear bits CREN and SREN.
- If interrupts are desired, then set enable bit TXIE.
- If 9-bit transmission is desired, then set bit TX9.
- Enable the transmission by setting bit TXEN.
- If 9-bit transmission is selected, the ninth bit should be loaded in bit TX9D.
- Start transmission by loading data to the TXREG register.

12.4.2 USART SYNCHRONOUS SLAVE RECEPTION

The operation of the synchronous master and slave modes is identical except in the case of the SLEEP mode. Also, enable bit SREN is a don't care in slave mode.

If receive is enabled by setting bit CREN prior to the SLEEP instruction, then a word may be received during SLEEP. On completely receiving the word, the RSR register will transfer the data to the RCREG register and if enable bit RCIE is set, the interrupt generated will wake the chip from SLEEP. If the global interrupt is enabled, the program will branch to the interrupt vector (0004h).

Steps to follow when setting up a Synchronous Slave Reception:

- Enable the synchronous master serial port by setting bits SYNC and SPEN, and clearing bit CSRC.
- If interrupts are desired, then set enable bit RCIE.
- If 9-bit reception is desired, then set bit RX9.
- To enable reception, set enable bit CREN.
- Flag bit RCIF will be set when reception is complete, and an interrupt will be generated if enable bit RCIE was set.
- Read the RCSTA register to get the ninth bit (if enabled) and determine if any error occurred during reception.
- Read the 8-bit received data by reading the RCREG register.
- If any error occurred, clear the error by clearing enable bit CREN.

TABLE 12-10: REGISTERS ASSOCIATED WITH SYNCHRONOUS SLAVE TRANSMISSION

Address	Name	Bit 7	Bit 6	Bit 5	Bit 4	Bit 3	Bit 2	Bit 1	Bit 0	Value on POR, BOR	Value on all other Resets
0Ch	PIR1	PSPIF ⁽¹⁾	(2)	RCIF	TXIF	SSPIF	CCP1IF	TMR2IF	TMR1IF	0000 0000	0000 0000
18h	RCSTA	SPEN	RX9	SREN	CREN	—	FERR	OERR	RX9D	0000 -00x	0000 -00x
19h	TXREG	USART Transmit Register								0000 0000	0000 0000
8Ch	PIE1	PSPIE ⁽¹⁾	(2)	RCIE	TXIE	SSPIE	CCP1IE	TMR2IE	TMR1IE	0000 0000	0000 0000
98h	TXSTA	CSRC	TX9	TXEN	SYNC	—	BRGH	TRMT	TX9D	0000 -010	0000 -010
99h	SPBRG	Baud Rate Generator Register								0000 0000	0000 0000

Legend: x = unknown, - = unimplemented locations read as '0'. Shaded cells are not used for Synchronous Slave Transmission.

Note 1: PSPIF and PSPIE are reserved on the PIC16C63/R63/66, always maintain these bits clear.

2: PIR1<6> and PIE1<6> are reserved, always maintain these bits clear.

TABLE 12-11: REGISTERS ASSOCIATED WITH SYNCHRONOUS SLAVE RECEPTION

Address	Name	Bit 7	Bit 6	Bit 5	Bit 4	Bit 3	Bit 2	Bit 1	Bit 0	Value on POR, BOR	Value on all other Resets
0Ch	PIR1	PSPIF ⁽¹⁾	(2)	RCIF	TXIF	SSPIF	CCP1IF	TMR2IF	TMR1IF	0000 0000	0000 0000
18h	RCSTA	SPEN	RX9	SREN	CREN	—	FERR	OERR	RX9D	0000 -00x	0000 -00x
1Ah	RCREG	USART Receive Register								0000 0000	0000 0000
8Ch	PIE1	PSPIE ⁽¹⁾	(2)	RCIE	TXIE	SSPIE	CCP1IE	TMR2IE	TMR1IE	0000 0000	0000 0000
98h	TXSTA	CSRC	TX9	TXEN	SYNC	—	BRGH	TRMT	TX9D	0000 -010	0000 -010
99h	SPBRG	Baud Rate Generator Register								0000 0000	0000 0000

Legend: x = unknown, - = unimplemented locations read as '0'. Shaded cells are not used for Synchronous Slave Reception.

Note 1: PSPIF and PSPIE are reserved on the PIC16C63/R63/66, always maintain these bits clear.

2: PIR1<6> and PIE1<6> are reserved, always maintain these bits clear.

PIC16C6X

NOTES:

13.0 SPECIAL FEATURES OF THE CPU

Applicable Devices													
61	62	62A	R62	63	R63	64	64A	R64	65	65A	R65	66	67

What sets a microcontroller apart from other processors are special circuits to deal with the needs of real-time applications. The PIC16CXX family has a host of such features intended to maximize system reliability, minimize cost through elimination of external components, provide power saving operating modes and offer code protection. These are:

- Oscillator selection
- Reset
 - Power-on Reset (POR)
 - Power-up Timer (PWRT)
 - Oscillator Start-up Timer (OST)
 - Brown-out Reset (BOR)
- Interrupts
- Watchdog Timer (WDT)
- SLEEP mode
- Code protection
- ID locations
- In-circuit serial programming

The PIC16CXX has a Watchdog Timer which can be shut off only through configuration bits. It runs off its own RC oscillator for added reliability. There are two

timers that offer necessary delays on power-up. One is the Oscillator Start-up Timer (OST), intended to keep the chip in RESET until the crystal oscillator is stable. The other is the Power-up Timer (PWRT), which provides a fixed delay of 72 ms (nominal) on power-up only, designed to keep the part in reset while the power supply stabilizes. With these two timers on-chip, most applications need no external reset circuitry.

SLEEP mode is designed to offer a very low current power-down mode. The user can wake from SLEEP through external reset, Watchdog Timer Wake-up or through an interrupt. Several oscillator options are also made available to allow the part to fit the application. The RC oscillator option saves system cost while the LP crystal option saves power. A set of configuration bits are used to select various options.

13.1 Configuration Bits

Applicable Devices													
61	62	62A	R62	63	R63	64	64A	R64	65	65A	R65	66	67

The configuration bits can be programmed (read as '0') or left unprogrammed (read as '1') to select various device configurations. These bits are mapped in program memory location 2007h.

The user will note that address 2007h is beyond the user program memory space. In fact, it belongs to the special test/configuration memory space (2000h - 3FFFh), which can be accessed only during programming.

FIGURE 13-1: CONFIGURATION WORD FOR PIC16C61



PIC16C6X

FIGURE 13-2: CONFIGURATION WORD FOR PIC16C62/64/65

—	—	—	—	—	—	—	—	—	CP1	CP0	PWRTE	WDTE	FOSC1	FOSC0	bit0	Register: CONFIG
bit13															Address: 2007h	
bit 13-6: Unimplemented: Read as '1'																
bit 5-4: CP1:CP0: Code Protection bits																
11 = Code protection off																
10 = Upper half of program memory code protected																
01 = Upper 3/4th of program memory code protected																
00 = All memory is code protected																
bit 3: PWRTE: Power-up Timer Enable bit																
1 = Power-up Timer enabled																
0 = Power-up Timer disabled																
bit 2: WDTE: Watchdog Timer Enable bit																
1 = WDT enabled																
0 = WDT disabled																
bit 1-0: FOSC1:FOSC0: Oscillator Selection bits																
11 = RC oscillator																
10 = HS oscillator																
01 = XT oscillator																
00 = LP oscillator																

FIGURE 13-3: CONFIGURATION WORD FOR PIC16C62A/R62/63/R63/64A/R64/65A/R65/66/67

CP1	CP0	CP1	CP0	CP1	CP0	—	BODEN	CP1	CP0	PWRTE	WDTE	FOSC1	FOSC0	bit0	Register: CONFIG
bit13															Address: 2007h
bit 13-8: CP1:CP0: Code Protection bits ⁽²⁾															
bit 5-4: 11 = Code protection off															
10 = Upper half of program memory code protected															
01 = Upper 3/4th of program memory code protected															
00 = All memory is code protected															
bit 7: Unimplemented: Read as '1'															
bit 6: BODEN: Brown-out Reset Enable bit ⁽¹⁾															
1 = Brown-out Reset enabled															
0 = Brown-out Reset disabled															
bit 3: PWRTE: Power-up Timer Enable bit ⁽¹⁾															
1 = Power-up Timer disabled															
0 = Power-up Timer enabled															
bit 2: WDTE: Watchdog Timer Enable bit															
1 = WDT enabled															
0 = WDT disabled															
bit 1-0: FOSC1:FOSC0: Oscillator Selection bits															
11 = RC oscillator															
10 = HS oscillator															
01 = XT oscillator															
00 = LP oscillator															
Note 1: Enabling Brown-out Reset automatically enables Power-up Timer (PWRT) regardless of the value of bit PWRTE . Ensure the Power-up Timer is enabled anytime Brown-out Reset is enabled.															
2: All of the CP1:CP0 pairs have to be given the same value to implement the code protection scheme listed.															

13.2 Oscillator Configurations

Applicable Devices

61	62	62A	R62	63	R63	64	64A	R64	65	65A	R65	66	67
----	----	-----	-----	----	-----	----	-----	-----	----	-----	-----	----	----

13.2.1 OSCILLATOR TYPES

The PIC16CXX can be operated in four different oscillator modes. The user can program two configuration bits (FOSC1 and FOSC0) to select one of these four modes:

- LP Low Power Crystal
- XT Crystal/Resonator
- HS High Speed Crystal/Resonator
- RC Resistor/Capacitor

13.2.2 CRYSTAL OSCILLATOR/CERAMIC RESONATORS

In LP, XT, or HS modes a crystal or ceramic resonator is connected to the OSC1/CLKIN and OSC2/CLKOUT pins to establish oscillation (Figure 13-4). The PIC16CXX oscillator design requires the use of a parallel cut crystal. Use of a series cut crystal may give a frequency out of the crystal manufacturers specifications. When in LP, XT, or HS modes, the device can have an external clock source to drive the OSC1/CLKIN pin (Figure 13-5).

FIGURE 13-4: CRYSTAL/CERAMIC RESONATOR OPERATION (HS, XT OR LP OSC CONFIGURATION)



FIGURE 13-5: EXTERNAL CLOCK INPUT OPERATION (HS, XT OR LP OSC CONFIGURATION)



PIC16C6X

**TABLE 13-1: CERAMIC RESONATORS
PIC16C61**

Ranges Tested:			
Mode	Freq	OSC1	OSC2
XT	455 kHz	47 - 100 pF	47 - 100 pF
	2.0 MHz	15 - 68 pF	15 - 68 pF
	4.0 MHz	15 - 68 pF	15 - 68 pF
HS	8.0 MHz	15 - 68 pF	15 - 68 pF
	16.0 MHz	10 - 47 pF	10 - 47 pF
These values are for design guidance only. See notes at bottom of page.			
Resonators Used:			
455 kHz	Panasonic EFO-A455K04B	± 0.3%	
2.0 MHz	Murata Erie CSA2.00MG	± 0.5%	
4.0 MHz	Murata Erie CSA4.00MG	± 0.5%	
8.0 MHz	Murata Erie CSA8.00MT	± 0.5%	
16.0 MHz	Murata Erie CSA16.00MX	± 0.5%	
All resonators used did not have built-in capacitors.			

**TABLE 13-2: CERAMIC RESONATORS
PIC16C62/62A/R62/63/R63/64/
64A/R64/65/65A/R65/66/67**

Ranges Tested:			
Mode	Freq	OSC1	OSC2
XT	455 kHz	68 - 100 pF	68 - 100 pF
	2.0 MHz	15 - 68 pF	15 - 68 pF
	4.0 MHz	15 - 68 pF	15 - 68 pF
HS	8.0 MHz	10 - 68 pF	10 - 68 pF
	16.0 MHz	10 - 22 pF	10 - 22 pF
These values are for design guidance only. See notes at bottom of page.			
Resonators Used:			
455 kHz	Panasonic EFO-A455K04B	± 0.3%	
2.0 MHz	Murata Erie CSA2.00MG	± 0.5%	
4.0 MHz	Murata Erie CSA4.00MG	± 0.5%	
8.0 MHz	Murata Erie CSA8.00MT	± 0.5%	
16.0 MHz	Murata Erie CSA16.00MX	± 0.5%	
All resonators used did not have built-in capacitors.			

**TABLE 13-3: CAPACITOR SELECTION FOR
CRYSTAL OSCILLATOR FOR
PIC16C61**

Mode	Freq	OSC1	OSC2
LP	32 kHz	33 - 68 pF	33 - 68 pF
	200 kHz	15 - 47 pF	15 - 47 pF
XT	100 kHz	47 - 100 pF	47 - 100 pF
	500 kHz	20 - 68 pF	20 - 68 pF
	1 MHz	15 - 68 pF	15 - 68 pF
	2 MHz	15 - 47 pF	15 - 47 pF
HS	4 MHz	15 - 33 pF	15 - 33 pF
	8 MHz	15 - 47 pF	15 - 47 pF
	20 MHz	15 - 47 pF	15 - 47 pF
These values are for design guidance only. See notes at bottom of page.			

**TABLE 13-4: CAPACITOR SELECTION FOR
CRYSTAL OSCILLATOR FOR
PIC16C62/62A/R62/63/R63/64/
64A/R64/65/65A/R65/66/67**

Osc Type	Crystal Freq	Cap. Range C1	Cap. Range C2
LP	32 kHz	33 pF	33 pF
	200 kHz	15 pF	15 pF
XT	200 kHz	47-68 pF	47-68 pF
	1 MHz	15 pF	15 pF
	4 MHz	15 pF	15 pF
HS	4 MHz	15 pF	15 pF
	8 MHz	15-33 pF	15-33 pF
	20 MHz	15-33 pF	15-33 pF
These values are for design guidance only. See notes at bottom of page.			
Crystals Used			
32 kHz	Epson C-001R32.768K-A	± 20 PPM	
200 kHz	STD XTL 200.000KHz	± 20 PPM	
1 MHz	ECS ECS-10-13-1	± 50 PPM	
4 MHz	ECS ECS-40-20-1	± 50 PPM	
8 MHz	EPSON CA-301 8.000M-C	± 30 PPM	
20 MHz	EPSON CA-301 20.000M-C	± 30 PPM	

- Note 1: Recommended values of C1 and C2 are identical to the ranges tested Table 13-1 and Table 13-2.
 2: Higher capacitance increases the stability of oscillator but also increases the start-up time.
 3: Since each resonator/crystal has its own characteristics, the user should consult the resonator/crystal manufacturer for appropriate values of external components.
 4: Rs may be required in HS mode as well as XT mode to avoid overdriving crystals with low drive level specification.

13.2.3 EXTERNAL CRYSTAL OSCILLATOR CIRCUIT

Either a prepackaged oscillator can be used or a simple oscillator circuit with TTL gates can be built. Prepackaged oscillators provide a wide operating range and better stability. A well-designed crystal oscillator will provide good performance with TTL gates. Two types of crystal oscillator circuits can be used; one with series resonance, or one with parallel resonance.

Figure 13-6 shows implementation of a parallel resonant oscillator circuit. The circuit is designed to use the fundamental frequency of the crystal. The 74AS04 inverter performs the 180-degree phase shift that a parallel oscillator requires. The 4.7 k Ω resistor provides the negative feedback for stability. The 10 k Ω potentiometer biases the 74AS04 in the linear region. This could be used for external oscillator designs.

FIGURE 13-6: EXTERNAL PARALLEL RESONANT CRYSTAL OSCILLATOR CIRCUIT



Figure 13-7 shows a series resonant oscillator circuit. This circuit is also designed to use the fundamental frequency of the crystal. The inverter performs a 180-degree phase shift in a series resonant oscillator circuit. The 330 k Ω resistors provide the negative feedback to bias the inverters in their linear region.

FIGURE 13-7: EXTERNAL SERIES RESONANT CRYSTAL OSCILLATOR CIRCUIT



13.2.4 RC OSCILLATOR

For timing insensitive applications the RC device option offers additional cost savings. The RC oscillator frequency is a function of the supply voltage, the resistor (R_{ext}) and capacitor (C_{ext}) values, and the operating temperature. In addition to this, the oscillator frequency will vary from unit to unit due to normal process parameter variation. Furthermore, the difference in lead frame capacitance between package types will also affect the oscillation frequency, especially for low C_{ext} values. The user also needs to take into account variation due to tolerance of external R and C components used. Figure 13-8 shows how the RC combination is connected to the PIC16CXX. For R_{ext} values below 2.2 k Ω , the oscillator operation may become unstable or stop completely. For very high R_{ext} values (e.g. 1 M Ω), the oscillator becomes sensitive to noise, humidity and leakage. Thus, we recommend keeping R_{ext} between 3 k Ω and 100 k Ω .

Although the oscillator will operate with no external capacitor ($C_{ext} = 0$ pF), we recommend using values above 20 pF for noise and stability reasons. With no or small external capacitance, the oscillation frequency can vary dramatically due to changes in external capacitances, such as PCB trace capacitance or package lead frame capacitance.

See characterization data for desired device for RC frequency variation from part to part due to normal process variation. The variation is larger for larger R (since leakage current variation will affect RC frequency more for large R) and for smaller C (since variation of input capacitance will affect RC frequency more).

See characterization data for desired device for variation of oscillator frequency due to V_{DD} for given R_{ext}/C_{ext} values as well as frequency variation due to operating temperature for given R, C, and V_{DD} values.

The oscillator frequency, divided by 4, is available on the OSC2/CLKOUT pin, and can be used for test purposes or to synchronize other logic (see Figure 3-5 for waveform).

FIGURE 13-8: RC OSCILLATOR MODE

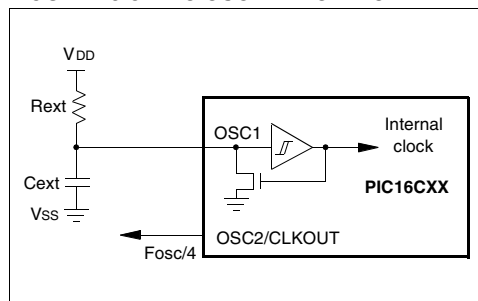

PIC16C6X

13.3 Reset

Applicable Devices													
61	62	62A	R62	63	R63	64	64A	R64	65	65A	R65	66	67

The PIC16CXX differentiates between various kinds of reset:

- Power-on Reset (POR)
- $\overline{\text{MCLR}}$ reset during normal operation
- $\overline{\text{MCLR}}$ reset during SLEEP
- WDT Reset (normal operation)
- Brown-out Reset (BOR) - Not on PIC16C61/62/64/65

Some registers are not affected in any reset condition, their status is unknown on POR and unchanged in any other reset. Most other registers are reset to a “reset state” on Power-on Reset (POR), on $\overline{\text{MCLR}}$ or WDT Reset, on $\overline{\text{MCLR}}$ reset during SLEEP, and on Brown-out Reset (BOR). They are not affected by a WDT Wake-up, which is viewed as the resumption of normal operation.

The $\overline{\text{TO}}$ and $\overline{\text{PD}}$ bits are set or cleared differently in different reset situations as indicated in Table 13-7, Table 13-8, and Table 13-9. These bits are used in software to determine the nature of the reset. See Table 13-12 for a full description of reset states of all registers.

A simplified block diagram of the on-chip reset circuit is shown in Figure 13-9.

On the PIC16C62A/R62/63/R63/64A/R64/65A/R65/66/67, the $\overline{\text{MCLR}}$ reset path has a noise filter to detect and ignore small pulses. See parameter #34 for pulse width specifications.

It should be noted that a WDT Reset does not drive the $\overline{\text{MCLR}}$ pin low.

FIGURE 13-9: SIMPLIFIED BLOCK DIAGRAM OF ON-CHIP RESET CIRCUIT



13.4 Power-on Reset (POR), Power-up Timer (PWRT), Oscillator Start-up Timer (OST) and Brown-out Reset (BOR)

Applicable Devices													
61	62	62A	R62	63	R63	64	64A	R64	65	65A	R65	66	67

13.4.1 POWER-ON RESET (POR)

A Power-on Reset pulse is generated on-chip when VDD rise is detected (in the range of 1.5V - 2.1V). To take advantage of the POR, just tie the MCLR/VPP pin directly (or through a resistor) to VDD. This will eliminate external RC components usually needed to create a Power-on Reset. A maximum rise time for VDD is required. See Electrical Specifications for details.

When the device starts normal operation (exits the reset condition), device operating parameters (voltage, frequency, temperature, ...) must be met to ensure operation. If these conditions are not met, the device must be held in reset until the operating conditions are met. Brown-out Reset may be used to meet the startup conditions.

For additional information, refer to Application Note AN607, "Power-up Trouble Shooting."

13.4.2 POWER-UP TIMER (PWRT)

The Power-up Timer provides a fixed 72 ms nominal time-out on power-up only, from POR. The Power-up Timer operates on an internal RC oscillator. The chip is kept in reset as long as PWRT is active. The PWRT's time delay allows VDD to rise to an acceptable level. A configuration bit is provided to enable/disable the PWRT.

The power-up time delay will vary from chip to chip due to VDD, temperature, and process variation. See DC parameters for details.

13.4.3 OSCILLATOR START-UP TIMER (OST)

The Oscillator Start-up Timer (OST) provides 1024 oscillator cycle (from OSC1 input) delay after the PWRT delay is over. This ensures the crystal oscillator or resonator has started and stabilized.

The OST time-out is invoked only for XT, LP and HS modes and only on Power-on Reset or wake-up from SLEEP.

13.4.4 BROWN-OUT RESET (BOR)

Applicable Devices													
61	62	62A	R62	63	R63	64	64A	R64	65	65A	R65	66	67

A configuration bit, BODEN, can disable (if clear/programmed) or enable (if set) the Brown-out Reset circuitry. If VDD falls below 4.0V (parameter D005 in Electrical Specification section) for greater than parameter #34 (see Electrical Specification section), the brown-out situation will reset the chip. A reset may not occur if VDD falls below 4.0V for less than parameter #34. The chip will remain in Brown-out Reset until VDD rises above BVDD. The Power-up Timer will now be invoked and will keep the chip in RESET an additional 72 ms. If VDD drops below BVDD while the Power-up Timer is running, the chip will go back into a Brown-out Reset and the Power-up Timer will be initialized. Once VDD rises above BVDD, the Power-up Timer will execute a 72 ms time delay. The Power-up Timer should always be enabled when Brown-out Reset is enabled. Figure 13-10 shows typical brown-out situations.

FIGURE 13-10: BROWN-OUT SITUATIONS



PIC16C6X

13.4.5 TIME-OUT SEQUENCE

On power-up the time-out sequence is as follows: First a PWRT time-out is invoked after the POR time delay has expired. Then OST is activated. The total time-out will vary based on oscillator configuration and the status of the PWRT. For example, in RC mode, with the PWRT disabled, there will be no time-out at all. Figure 13-11, Figure 13-12, and Figure 13-13 depict time-out sequences on power-up.

Since the time-outs occur from the POR pulse, if the MCLR/VPP pin is kept low long enough, the time-outs will expire. Then bringing the MCLR/VPP pin high will begin execution immediately (Figure 13-14). This is useful for testing purposes or to synchronize more than one PIC16CXX device operating in parallel.

Table 13-10 and Table 13-11 show the reset conditions for some special function registers, while Table 13-12 shows the reset conditions for all the registers.

13.4.6 POWER CONTROL/STATUS REGISTER (PCON)

Applicable Devices

61	62	62A	R62	63	R63	64	64A	R64	65	65A	R65	66	67
----	----	-----	-----	----	-----	----	-----	-----	----	-----	-----	----	----

The Power Control/Status Register, PCON has up to two bits, depending upon the device. Bit0 is not implemented on the PIC16C62/64/65.

Bit0 is $\overline{\text{BOR}}$ (Brown-out Reset Status bit). $\overline{\text{BOR}}$ is unknown on Power-on Reset. It must then be set by the user and checked on subsequent resets to see if $\overline{\text{BOR}}$ cleared, indicating that a brown-out has occurred. The $\overline{\text{BOR}}$ status bit is a “Don’t Care” and is not necessarily predictable if the Brown-out Reset circuitry is disabled (by clearing bit BODEN in the Configuration Word).

Bit1 is $\overline{\text{POR}}$ (Power-on Reset Status bit). It is cleared on a Power-on Reset and unaffected otherwise. The user must set this bit following a Power-on Reset.

TABLE 13-5: TIME-OUT IN VARIOUS SITUATIONS, PIC16C61/62/64/65

Oscillator Configuration	Power-up		Wake-up from SLEEP
	PWRTE = 1	PWRTE = 0	
XT, HS, LP	72 ms + 1024T _{OSC}	1024T _{OSC}	1024 T _{OSC}
RC	72 ms	—	—

TABLE 13-6: TIME-OUT IN VARIOUS SITUATIONS, PIC16C62A/R62/63/R63/64A/R64/65A/R65/66/67

Oscillator Configuration	Power-up		Brown-out	Wake up from SLEEP
	PWRTE = 0	PWRTE = 1		
XT, HS, LP	72 ms + 1024T _{OSC}	1024T _{OSC}	72 ms + 1024T _{OSC}	1024 T _{OSC}
RC	72 ms	—	72 ms	—

TABLE 13-7: STATUS BITS AND THEIR SIGNIFICANCE, PIC16C61

$\overline{\text{TO}}$	$\overline{\text{PD}}$	
1	1	Power-on Reset or MCLR reset during normal operation
0	1	WDT Reset
0	0	WDT Wake-up
1	0	MCLR reset during SLEEP or interrupt wake-up from SLEEP

TABLE 13-8: STATUS BITS AND THEIR SIGNIFICANCE, PIC16C62/64/65

$\overline{\text{POR}}$	$\overline{\text{TO}}$	$\overline{\text{PD}}$	
0	1	1	Power-on Reset
0	0	x	Illegal, $\overline{\text{TO}}$ is set on a Power-on Reset
0	x	0	Illegal, $\overline{\text{PD}}$ is set on a Power-on Reset
1	0	1	WDT Reset
1	0	0	WDT Wake-up
1	u	u	MCLR reset during normal operation
1	1	0	MCLR reset during SLEEP or interrupt wake-up from SLEEP

Legend: x = unknown, u = unchanged

TABLE 13-9: STATUS BITS AND THEIR SIGNIFICANCE FOR PIC16C62A/R62/63/R63/64A/R64/65A/R65/66/67

POR	BOR	\overline{TO}	PD	
0	x	1	1	Power-on Reset
0	x	0	x	Illegal, \overline{TO} is set on a Power-on Reset
0	x	x	0	Illegal, PD is set on a Power-on Reset
1	0	x	x	Brown-out Reset
1	1	0	1	WDT Reset
1	1	0	0	WDT Wake-up
1	1	u	u	MCLR reset during normal operation
1	1	1	0	MCLR reset during SLEEP or interrupt wake-up from SLEEP

Legend: x = unknown, u = unchanged

TABLE 13-10: RESET CONDITION FOR SPECIAL REGISTERS ON PIC16C61/62/64/65

	Program Counter	STATUS	PCON ⁽²⁾
Power-on Reset	000h	0001 1xxx	---- --0-
MCLR reset during normal operation	000h	000u uuuu	---- --u-
MCLR reset during SLEEP	000h	0001 0uuu	---- --u-
WDT Reset	000h	0000 1uuu	---- --u-
WDT Wake-up	PC + 1	uuu0 0uuu	---- --u-
Interrupt wake-up from SLEEP	PC + 1 ⁽¹⁾	uuu1 0uuu	---- --u-

Legend: u = unchanged, x = unknown, - = unimplemented bit read as '0'.

Note 1: When the wake-up is due to an interrupt and the global enable bit, GIE is set, the PC is loaded with the interrupt vector (0004h) after execution of PC+1.

2: The PCON register is not implemented on the PIC16C61.

TABLE 13-11: RESET CONDITION FOR SPECIAL REGISTERS ON PIC16C62A/R62/63/R63/64A/R64/65A/R65/66/67

	Program Counter	STATUS	PCON
Power-on Reset	000h	0001 1xxx	---- --0x
MCLR reset during normal operation	000h	000u uuuu	---- --uu
MCLR reset during SLEEP	000h	0001 0uuu	---- --uu
WDT Reset	000h	0000 1uuu	---- --uu
Brown-out Reset	000h	0001 1uuu	---- --u0
WDT Wake-up	PC + 1	uuu0 0uuu	---- --uu
Interrupt wake-up from SLEEP	PC + 1 ⁽¹⁾	uuu1 0uuu	---- --uu

Legend: u = unchanged, x = unknown, - = unimplemented bit read as '0'.

Note 1: When the wake-up is due to an interrupt and global enable bit, GIE is set, the PC is loaded with the interrupt vector (0004h) after execution of PC+1.

PIC16C6X

TABLE 13-12: INITIALIZATION CONDITIONS FOR ALL REGISTERS

Register	Applicable Devices													Power-on Reset Brown-out Reset	MCLR Reset during: – normal operation – SLEEP WDT Reset	Wake-up via interrupt or WDT Wake-up	
W	61	62	62A	R62	63	R63	64	64A	R64	65	65A	R65	66	67	xxxx xxxx	uuuu uuuu	uuuu uuuu
INDF	61	62	62A	R62	63	R63	64	64A	R64	65	65A	R65	66	67	N/A	N/A	N/A
TMR0	61	62	62A	R62	63	R63	64	64A	R64	65	65A	R65	66	67	xxxx xxxx	uuuu uuuu	uuuu uuuu
PCL	61	62	62A	R62	63	R63	64	64A	R64	65	65A	R65	66	67	0000h	0000h	PC + 1 ⁽²⁾
STATUS	61	62	62A	R62	63	R63	64	64A	R64	65	65A	R65	66	67	0001 1xxx	000q quuu ⁽³⁾	uuuq quuu ⁽³⁾
FSR	61	62	62A	R62	63	R63	64	64A	R64	65	65A	R65	66	67	xxxx xxxx	uuuu uuuu	uuuu uuuu
PORTA	61	62	62A	R62	63	R63	64	64A	R64	65	65A	R65	66	67	--x xxxx	---u uuuu	---u uuuu
	61	62	62A	R62	63	R63	64	64A	R64	65	65A	R65	66	67	--xx xxxx	--uu uuuu	--uu uuuu
PORTB	61	62	62A	R62	63	R63	64	64A	R64	65	65A	R65	66	67	xxxx xxxx	uuuu uuuu	uuuu uuuu
PORTC	61	62	62A	R62	63	R63	64	64A	R64	65	65A	R65	66	67	xxxx xxxx	uuuu uuuu	uuuu uuuu
PORTD	61	62	62A	R62	63	R63	64	64A	R64	65	65A	R65	66	67	xxxx xxxx	uuuu uuuu	uuuu uuuu
PORTE	61	62	62A	R62	63	R63	64	64A	R64	65	65A	R65	66	67	---- -xxx	---- -uuu	---- -uuu
PCLATH	61	62	62A	R62	63	R63	64	64A	R64	65	65A	R65	66	67	---0 0000	---0 0000	---u uuuu
INTCON	61	62	62A	R62	63	R63	64	64A	R64	65	65A	R65	66	67	0000 000x	0000 000u	uuuu uuuu ⁽¹⁾
PIR1	61	62	62A	R62	63	R63	64	64A	R64	65	65A	R65	66	67	00-- 0000	00-- 0000	uu-- uuuu ⁽¹⁾
	61	62	62A	R62	63	R63	64	64A	R64	65	65A	R65	66	67	0000 0000	0000 0000	uuuu uuuu ⁽¹⁾
PIR2	61	62	62A	R62	63	R63	64	64A	R64	65	65A	R65	66	67	---- --0	---- --0	---- --u ⁽²⁾
TMR1L	61	62	62A	R62	63	R63	64	64A	R64	65	65A	R65	66	67	xxxx xxxx	uuuu uuuu	uuuu uuuu
TMR1H	61	62	62A	R62	63	R63	64	64A	R64	65	65A	R65	66	67	xxxx xxxx	uuuu uuuu	uuuu uuuu
T1CON	61	62	62A	R62	63	R63	64	64A	R64	65	65A	R65	66	67	--00 0000	--uu uuuu	--uu uuuu
TMR2	61	62	62A	R62	63	R63	64	64A	R64	65	65A	R65	66	67	0000 0000	0000 0000	uuuu uuuu
T2CON	61	62	62A	R62	63	R63	64	64A	R64	65	65A	R65	66	67	-000 0000	-000 0000	-uuu uuuu
SSPBUF	61	62	62A	R62	63	R63	64	64A	R64	65	65A	R65	66	67	xxxx xxxx	uuuu uuuu	uuuu uuuu
SSPCON	61	62	62A	R62	63	R63	64	64A	R64	65	65A	R65	66	67	0000 0000	0000 0000	uuuu uuuu
CCPR1L	61	62	62A	R62	63	R63	64	64A	R64	65	65A	R65	66	67	xxxx xxxx	uuuu uuuu	uuuu uuuu
CCPR1H	61	62	62A	R62	63	R63	64	64A	R64	65	65A	R65	66	67	xxxx xxxx	uuuu uuuu	uuuu uuuu
CCP1CON	61	62	62A	R62	63	R63	64	64A	R64	65	65A	R65	66	67	--00 0000	--00 0000	--uu uuuu
RCSTA	61	62	62A	R62	63	R63	64	64A	R64	65	65A	R65	66	67	0000 -00x	0000 -00x	uuuu -uuu
TXREG	61	62	62A	R62	63	R63	64	64A	R64	65	65A	R65	66	67	0000 0000	0000 0000	uuuu uuuu
RCREG	61	62	62A	R62	63	R63	64	64A	R64	65	65A	R65	66	67	0000 0000	0000 0000	uuuu uuuu
CCPR2L	61	62	62A	R62	63	R63	64	64A	R64	65	65A	R65	66	67	xxxx xxxx	uuuu uuuu	uuuu uuuu
CCPR2H	61	62	62A	R62	63	R63	64	64A	R64	65	65A	R65	66	67	xxxx xxxx	uuuu uuuu	uuuu uuuu
CCP2CON	61	62	62A	R62	63	R63	64	64A	R64	65	65A	R65	66	67	0000 0000	0000 0000	uuuu uuuu
OPTION	61	62	62A	R62	63	R63	64	64A	R64	65	65A	R65	66	67	1111 1111	1111 1111	uuuu uuuu
TRISA	61	62	62A	R62	63	R63	64	64A	R64	65	65A	R65	66	67	--1 1111	--1 1111	--u uuuu
	61	62	62A	R62	63	R63	64	64A	R64	65	65A	R65	66	67	--11 1111	--11 1111	--uu uuuu
TRISB	61	62	62A	R62	63	R63	64	64A	R64	65	65A	R65	66	67	1111 1111	1111 1111	uuuu uuuu
TRISC	61	62	62A	R62	63	R63	64	64A	R64	65	65A	R65	66	67	1111 1111	1111 1111	uuuu uuuu

Legend: u = unchanged, x = unknown, - = unimplemented bit read as '0', q = value depends on condition.

Note 1: One or more bits in INTCON, PIR1 and/or PIR2 will be affected (to cause wake-up).

2: When the wake-up is due to an interrupt and the global enable bit, GIE is set, the PC is loaded with the interrupt vector (0004h) after execution of PC + 1.

3: See Table 13-10 and Table 13-11 for reset value for specific conditions.

TABLE 13-12: INITIALIZATION CONDITIONS FOR ALL REGISTERS (Cont.'d)

Register	Applicable Devices															Power-on Reset Brown-out Reset	MCLR Reset during: – normal operation – SLEEP WDT Reset	Wake-up via interrupt or WDT Wake-up
	61	62	62A	R62	63	R63	64	64A	R64	65	65A	R65	66	67				
TRISD	61	62	62A	R62	63	R63	64	64A	R64	65	65A	R65	66	67	1111 1111	1111 1111	uuuu uuuu	
TRISE	61	62	62A	R62	63	R63	64	64A	R64	65	65A	R65	66	67	0000 -111	0000 -111	uuuu -uuu	
PIE1	61	62	62A	R62	63	R63	64	64A	R64	65	65A	R65	66	67	00-- 0000	00-- 0000	uu-- uuuu	
	61	62	62A	R62	63	R63	64	64A	R64	65	65A	R65	66	67	0000 0000	0000 0000	uuuu uuuu	
PIE2	61	62	62A	R62	63	R63	64	64A	R64	65	65A	R65	66	67	---- --0	---- --0	---- --u	
PCON	61	62	62A	R62	63	R63	64	64A	R64	65	65A	R65	66	67	---- --0u	---- --uu	---- --uu	
	61	62	62A	R62	63	R63	64	64A	R64	65	65A	R65	66	67	---- --0-	---- --u-	---- --u-	
PR2	61	62	62A	R62	63	R63	64	64A	R64	65	65A	R65	66	67	1111 1111	1111 1111	1111 1111	
SSPADD	61	62	62A	R62	63	R63	64	64A	R64	65	65A	R65	66	67	0000 0000	0000 0000	uuuu uuuu	
SSPSTAT	61	62	62A	R62	63	R63	64	64A	R64	65	65A	R65	66	67	--00 0000	--00 0000	--uu uuuu	
TXSTA	61	62	62A	R62	63	R63	64	64A	R64	65	65A	R65	66	67	0000 -010	0000 -010	uuuu -uuu	
SPBRG	61	62	62A	R62	63	R63	64	64A	R64	65	65A	R65	66	67	0000 0000	0000 0000	uuuu uuuu	

Legend: u = unchanged, x = unknown, - = unimplemented bit read as '0', q = value depends on condition.

Note 1: One or more bits in INTCON, PIR1 and/or PIR2 will be affected (to cause wake-up).

2: When the wake-up is due to an interrupt and the global enable bit, GIE is set, the PC is loaded with the interrupt vector (0004h) after execution of PC + 1.

3: See Table 13-10 and Table 13-11 for reset value for specific conditions.

PIC16C6X

FIGURE 13-11: TIME-OUT SEQUENCE ON POWER-UP ($\overline{\text{MCLR}}$ NOT TIED TO V_{DD}): CASE 1



FIGURE 13-12: TIME-OUT SEQUENCE ON POWER-UP ($\overline{\text{MCLR}}$ NOT TIED TO V_{DD}): CASE 2



FIGURE 13-13: TIME-OUT SEQUENCE ON POWER-UP ($\overline{\text{MCLR}}$ TIED TO V_{DD})



FIGURE 13-14: EXTERNAL POWER-ON RESET CIRCUIT (FOR SLOW VDD POWER-UP)



FIGURE 13-15: EXTERNAL BROWN-OUT PROTECTION CIRCUIT 1



FIGURE 13-16: EXTERNAL BROWN-OUT PROTECTION CIRCUIT 2



PIC16C6X

13.5 Interrupts

Applicable Devices													
61	62	62A	R62	63	R63	64	64A	R64	65	65A	R65	66	67

The PIC16C6X family has up to 11 sources of interrupt. The interrupt control register (INTCON) records individual interrupt requests in flag bits. It also has individual and global interrupt enable bits.

Note: Individual interrupt flag bits are set regardless of the status of their corresponding mask bit or global enable bit, GIE.

Global interrupt enable bit, GIE (INTCON<7>) enables (if set) all un-masked interrupts or disables (if cleared) all interrupts. When bit GIE is enabled, and an interrupt flag bit and mask bit are set, the interrupt will vector immediately. Individual interrupts can be disabled through their corresponding enable bits in the INTCON register. GIE is cleared on reset.

The “return from interrupt” instruction, RETFIE, exits the interrupt routine as well as sets the GIE bit, which re-enable interrupts.

The RB0/INT pin interrupt, the RB port change interrupt and the TMR0 overflow interrupt flag bits are contained in the INTCON register.

The peripheral interrupt flag bits are contained in special function registers PIR1 and PIR2. The corresponding interrupt enable bits are contained in special function registers PIE1 and PIE2 and the peripheral interrupt enable bit is contained in special function register INTCON.

When an interrupt is responded to, bit GIE is cleared to disable any further interrupts, the return address is pushed onto the stack and the PC is loaded with 0004h. Once in the interrupt service routine the source(s) of the interrupt can be determined by polling the interrupt flag bits. The interrupt flag bit(s) must be cleared in software before re-enabling interrupts to avoid recursive interrupts.

For external interrupt events, such as the RB0/INT pin or RB port change interrupt, the interrupt latency will be three or four instruction cycles. The exact latency depends when the interrupt event occurs (Figure 13-19). The latency is the same for one or two cycle instructions. Once in the interrupt service routine the source(s) of the interrupt can be determined by polling the interrupt flag bits. The interrupt flag bit(s) must be cleared in software before re-enabling interrupts to

avoid infinite interrupt requests. Individual interrupt flag bits are set regardless of the status of their corresponding mask bit or the GIE bit.

Note: For the PIC16C61/62/64/65, if an interrupt occurs while the Global Interrupt Enable bit, GIE is being cleared, bit GIE may unintentionally be re-enabled by the user's Interrupt Service Routine (the RETFIE instruction). The events that would cause this to occur are:

1. An instruction clears the GIE bit while an interrupt is acknowledged
2. The program branches to the Interrupt vector and executes the Interrupt Service Routine.
3. The Interrupt Service Routine completes with the execution of the RETFIE instruction. This causes the GIE bit to be set (enables interrupts), and the program returns to the instruction after the one which was meant to disable interrupts.
4. Perform the following to ensure that interrupts are globally disabled.

```
LOOP BCF INTCON,GIE      ;Disable Global
                          ;Interrupt bit
      BTFSC INTCON,GIE    ;Global Interrupt
                          ;Disabled?
      GOTO LOOP          ;NO, try again
      :                  ;Yes, continue
                          ;with program flow
```

FIGURE 13-17: INTERRUPT LOGIC FOR PIC16C61



FIGURE 13-18: INTERRUPT LOGIC FOR PIC16C6X



The following table shows which devices have which interrupts.

Device	TOIF	INTF	RBIF	PSPIF	RCIF	TXIF	SSPIF	CCP1IF	TMR2IF	TMR1IF	CCP2IF
PIC16C62	Yes	Yes	Yes	-	-	-	Yes	Yes	Yes	Yes	-
PIC16C62A	Yes	Yes	Yes	-	-	-	Yes	Yes	Yes	Yes	-
PIC16CR62	Yes	Yes	Yes	-	-	-	Yes	Yes	Yes	Yes	-
PIC16C63	Yes	Yes	Yes	-	Yes	Yes	Yes	Yes	Yes	Yes	Yes
PIC16CR63	Yes	Yes	Yes	-	Yes	Yes	Yes	Yes	Yes	Yes	Yes
PIC16C64	Yes	Yes	Yes	Yes	-	-	Yes	Yes	Yes	Yes	-
PIC16C64A	Yes	Yes	Yes	Yes	-	-	Yes	Yes	Yes	Yes	-
PIC16C64	Yes	Yes	Yes	Yes	-	-	Yes	Yes	Yes	Yes	-
PIC16C65	Yes	Yes	Yes	Yes	Yes	Yes	Yes	Yes	Yes	Yes	Yes
PIC16C65A	Yes	Yes	Yes	Yes	Yes	Yes	Yes	Yes	Yes	Yes	Yes
PIC16CR65	Yes	Yes	Yes	Yes	Yes	Yes	Yes	Yes	Yes	Yes	Yes
PIC16C66	Yes	Yes	Yes	-	Yes	Yes	Yes	Yes	Yes	Yes	Yes
PIC16C67	Yes	Yes	Yes	Yes	Yes	Yes	Yes	Yes	Yes	Yes	Yes

PIC16C6X

13.5.1 INT INTERRUPT

External interrupt on RB0/INT pin is edge triggered: either rising if edge select bit INTEDG (OPTION<6>) is set, or falling, if bit INTEDG is clear. When a valid edge appears on the RB0/INT pin, flag bit INTF (INTCON<1>) is set. This interrupt can be disabled by clearing enable bit INTE (INTCON<4>). The INTF bit must be cleared in software in the interrupt service routine before re-enabling this interrupt. The INT interrupt can wake the processor from SLEEP, if enable bit INTE was set prior to going into SLEEP. The status of global enable bit GIE decides whether or not the processor branches to the interrupt vector following wake-up. See Section 13.8 for details on SLEEP mode.

13.5.2 TMR0 INTERRUPT

An overflow (FFh → 00h) in the TMR0 register will set flag bit T0IF (INTCON<2>). The interrupt can be enabled/disabled by setting/clearing enable bit T0IE (INTCON<5>) (Section 7.0).

13.5.3 PORTB INTERRUPT ON CHANGE

An input change on PORTB<7:4> sets flag bit RBIF (INTCON<0>). The interrupt can be enabled/disabled by setting/clearing enable bit RBIE (INTCON<4>) (Section 5.2).

Note: For the PIC16C61/62/64/65, if a change on the I/O pin should occur when the read operation is being executed (start of the Q2 cycle), then flag bit RBIF may not get set.

FIGURE 13-19: INT PIN INTERRUPT TIMING



13.6 Context Saving During Interrupts

Applicable Devices

61	62	62A	R62	63	R63	64	64A	R64	65	65A	R65	66	67
----	----	-----	-----	----	-----	----	-----	-----	----	-----	-----	----	----

During an interrupt, only the return PC value is saved on the stack. Typically, users may wish to save key registers during an interrupt i.e., W register and STATUS register. This will have to be implemented in software.

Example 13-1 stores and restores the STATUS and W registers. Example 13-2 stores and restores the STATUS, W, and PCLATH registers (Devices with paged program memory). For all PIC16C6X devices with greater than 1K of program memory (all devices except PIC16C61), the register, W_TEMP, must be

defined in **all** banks and must be defined at the same offset from the bank base address (i.e., if W_TEMP is defined at 0x20 in bank 0, it must also be defined at 0xA0 in bank 1, 0x120 in bank 2, and 0x1A0 in bank 3).

The examples:

- Stores the W register
- Stores the STATUS register in bank 0
- Stores PCLATH
- Executes ISR code
- Restores PCLATH
- Restores STATUS register (and bank select bit)
- Restores W register

EXAMPLE 13-1: SAVING STATUS AND W REGISTERS IN RAM (PIC16C61)

```

MOVWF    W_TEMP           ;Copy W to TEMP register, could be bank one or zero
SWAPF    STATUS,W         ;Swap status to be saved into W
MOVWF    STATUS_TEMP      ;Save status to bank zero STATUS_TEMP register
:
:(ISR)
:
SWAPF    STATUS_TEMP,W    ;Swap STATUS_TEMP register into W
                        ;(sets bank to original state)

MOVWF    STATUS           ;Move W into STATUS register
SWAPF    W_TEMP,F         ;Swap W_TEMP
SWAPF    W_TEMP,W         ;Swap W_TEMP into W
    
```

EXAMPLE 13-2: SAVING STATUS, W, AND PCLATH REGISTERS IN RAM (ALL OTHER PIC16C6X DEVICES)

```

MOVWF    W_TEMP           ;Copy W to TEMP register, could be bank one or zero
SWAPF    STATUS,W         ;Swap status to be saved into W
CLRF     STATUS           ;bank 0, regardless of current bank, Clears IRP,RP1,RP0
MOVWF    STATUS_TEMP      ;Save status to bank zero STATUS_TEMP register
MOVF     PCLATH,W         ;Only required if using pages 1, 2 and/or 3
MOVWF    PCLATH_TEMP      ;Save PCLATH into W
CLRF     PCLATH           ;Page zero, regardless of current page
BCF     STATUS, IRP       ;Return to Bank 0
MOVF     FSR,W            ;Copy FSR to W
MOVWF    FSR_TEMP         ;Copy FSR from W to FSR_TEMP
:(ISR)
:
MOVF     PCLATH_TEMP,W    ;Restore PCLATH
MOVWF    PCLATH           ;Move W into PCLATH
SWAPF    STATUS_TEMP,W    ;Swap STATUS_TEMP register into W
                        ;(sets bank to original state)

MOVWF    STATUS           ;Move W into STATUS register
SWAPF    W_TEMP,F         ;Swap W_TEMP
SWAPF    W_TEMP,W         ;Swap W_TEMP into W
    
```

PIC16C6X

13.7 Watchdog Timer (WDT)

Applicable Devices													
61	62	62A	R62	63	R63	64	64A	R64	65	65A	R65	66	67

The Watchdog Timer is a free running on-chip RC oscillator which does not require any external components. This RC oscillator is separate from the RC oscillator of the OSC1/CLKIN pin. That means that the WDT will run, even if the clock on the OSC1/CLKIN and OSC2/CLKOUT pins of the device has been stopped, for example, by execution of a `SLEEP` instruction. During normal operation, a WDT time-out generates a device reset. If the device is in `SLEEP` mode, a WDT time-out causes the device to wake-up and continue with normal operation (WDT Wake-up). The WDT can be permanently disabled by clearing configuration bit `WDTE` (Section 13.1).

13.7.1 WDT PERIOD

The WDT has a nominal time-out period of 18 ms, (with no prescaler). The time-out periods vary with temperature, V_{DD} and process variations from part to part (see DC specs). If longer time-out periods are desired, a prescaler with a division ratio of up to 1:128 can be

assigned to the WDT under software control by writing to the `OPTION` register. Thus, time-out periods up to 2.3 seconds can be realized.

The `CLRWDT` and `SLEEP` instructions clear the WDT and the postscaler, if assigned to the WDT, and prevent it from timing out and generating a device `RESET` condition.

The \overline{TO} bit in the `STATUS` register will be cleared upon a WDT time-out.

13.7.2 WDT PROGRAMMING CONSIDERATIONS

It should also be taken in account that under worst case conditions ($V_{DD} = \text{Min.}$, Temperature = Max. , max. WDT prescaler) it may take several seconds before a WDT time-out occurs.

Note: When a `CLRWDT` instruction is executed and the prescaler is assigned to the WDT, the prescaler count will be cleared, but the prescaler assignment is not changed.

FIGURE 13-20: WATCHDOG TIMER BLOCK DIAGRAM



FIGURE 13-21: SUMMARY OF WATCHDOG TIMER REGISTERS

Address	Name	Bit 7	Bit 6	Bit 5	Bit 4	Bit 3	Bit 2	Bit 1	Bit 0
2007h	Config. bits	(1)	BODEN ⁽¹⁾	CP1	CP0	PWRTE ⁽¹⁾	WDTE	FOSC1	FOSC0
81h,181h	OPTION	\overline{RBPU}	INTEDG	T0CS	T0SE	PSA	PS2	PS1	PS0

Legend: Shaded cells are not used by the Watchdog Timer.

Note 1: See Figure 13-1, Figure 13-2, and Figure 13-3 for details of these bits for the specific device.

13.8 Power-down Mode (SLEEP)

Applicable Devices													
61	62	62A	R62	63	R63	64	64A	R64	65	65A	R65	66	67

Power-down mode is entered by executing a `SLEEP` instruction.

If enabled, the Watchdog Timer will be cleared but keeps running, status bit \overline{PD} (STATUS<3>) is cleared, status bit \overline{TO} (STATUS<4>) is set, and the oscillator driver is turned off. The I/O ports maintain the status they had before the `SLEEP` instruction was executed (driving high, low, or hi-impedance).

For lowest current consumption in this mode, place all I/O pins at either V_{DD} , or V_{SS} , ensure no external circuitry is drawing current from the I/O pin, and disable external clocks. Pull all I/O pins, that are hi-impedance inputs, high or low externally to avoid switching currents caused by floating inputs. The $T0CKI$ input should also be at V_{DD} or V_{SS} for lowest current consumption. The contribution from on-chip pull-ups on $PORTB$ should be considered.

The \overline{MCLR}/V_{PP} pin must be at a logic high level (V_{IHMC}).

13.8.1 WAKE-UP FROM SLEEP

The device can wake from `SLEEP` through one of the following events:

1. External reset input on \overline{MCLR}/V_{PP} pin.
2. Watchdog Timer Wake-up (if `WDT` was enabled).
3. Interrupt from $RB0/INT$ pin, RB port change, or some peripheral interrupts.

External \overline{MCLR} Reset will cause a device reset. All other events are considered a continuation of program execution and cause a "wake-up". The \overline{TO} and \overline{PD} bits in the `STATUS` register can be used to determine the cause of device reset. The \overline{PD} bit, which is set on power-up is cleared when `SLEEP` is invoked. The \overline{TO} bit is cleared if `WDT` time-out occurred (and caused wake-up).

The following peripheral interrupts can wake the device from `SLEEP`:

1. `TMR1` interrupt. `Timer1` must be operating as an asynchronous counter.
2. `SSP` (Start/Stop) bit detect interrupt.
3. `SSP` transmit or receive in slave mode (`SPI/I2C`).
4. `CCP` capture mode interrupt.
5. Parallel Slave Port read or write.
6. `USART TX` or `RX` (synchronous slave mode).

Other peripherals can not generate interrupts since during `SLEEP`, no on-chip Q clocks are present.

When the `SLEEP` instruction is being executed, the next instruction (`PC + 1`) is pre-fetched. For the device to wake-up through an interrupt event, the corresponding interrupt enable bit must be set (enabled). Wake-up is regardless of the state of the `GIE` bit. If the `GIE` bit is clear (disabled), the device continues execution at the instruction after the `SLEEP` instruction. If the `GIE` bit is set (enabled), the device executes the instruction after the `SLEEP` instruction and then branches to the interrupt address (0004h). In cases where the execution of the instruction following `SLEEP` is not desirable, the user should have a `NOP` after the `SLEEP` instruction.

13.8.2 WAKE-UP USING INTERRUPTS

When global interrupts are disabled (`GIE` cleared) and any interrupt source has both its interrupt enable bit and interrupt flag bit set, one of the following will occur:

- If the interrupt occurs **before** the execution of a `SLEEP` instruction, the `SLEEP` instruction will complete as a `NOP`. Therefore, the `WDT` and `WDT` postscaler will not be cleared, the \overline{TO} bit will not be set and \overline{PD} bits will not be cleared.
- If the interrupt occurs **during or after** the execution of a `SLEEP` instruction, the device will immediately wake up from sleep. The `SLEEP` instruction will be completely executed before the wake-up. Therefore, the `WDT` and `WDT` postscaler will be cleared, the \overline{TO} bit will be set and the \overline{PD} bit will be cleared.

Even if the flag bits were checked before executing a `SLEEP` instruction, it may be possible for flag bits to become set before the `SLEEP` instruction completes. To determine whether a `SLEEP` instruction executed, test the \overline{PD} bit. If the \overline{PD} bit is set, the `SLEEP` instruction was executed as a `NOP`.

To ensure that the `WDT` is cleared, a `CLRWDT` instruction should be executed before a `SLEEP` instruction.

PIC16C6X

FIGURE 13-22: WAKE-UP FROM SLEEP THROUGH INTERRUPT



13.9 Program Verification/Code Protection

Applicable Devices													
61	62	62A	R62	63	R63	64	64A	R64	65	65A	R65	66	67

If the code protection bit(s) have not been programmed, the on-chip program memory can be read out for verification purposes.

Note: Microchip does not recommend code protecting windowed devices.

13.10 ID Locations

Applicable Devices													
61	62	62A	R62	63	R63	64	64A	R64	65	65A	R65	66	67

Four memory locations (2000h - 2003h) are designated as ID locations where the user can store checksum or other code-identification numbers. These locations are not accessible during normal execution but are readable and writable during program/verify. It is recommended that only the 4 least significant bits of the ID location are used.

For ROM devices, these values are submitted along with the ROM code.

13.11 In-Circuit Serial Programming

Applicable Devices													
61	62	62A	R62	63	R63	64	64A	R64	65	65A	R65	66	67

The PIC16CXX microcontrollers can be serially programmed while in the end application circuit. This is simply done with two lines for clock and data, and three other lines for power, ground, and the programming voltage. This allows customers to manufacture boards with unprogrammed devices, and then program the microcontroller just before shipping the product. This also allows the most recent firmware or a custom firmware to be programmed.

The device is placed into a program/verify mode by holding pins RB6 and RB7 low while raising the MCLR (VPP) pin from V_{IL} to V_{IH} (see programming specification). RB6 becomes the programming clock and RB7 becomes the programming data. Both RB6 and RB7 are Schmitt Trigger inputs in this mode.

After reset, to place the device in program/verify mode, the program counter (PC) is at location 00h. A 6-bit command is then supplied to the device. Depending on the command, 14-bits of program data are then supplied to or from the device, depending if the command was a load or a read. For complete details of serial programming, please refer to the PIC16C6X/7X Programming Specifications (Literature #DS30228).

FIGURE 13-23: TYPICAL IN-CIRCUIT SERIAL PROGRAMMING CONNECTION



14.0 INSTRUCTION SET SUMMARY

Each PIC16CXX instruction is a 14-bit word divided into an OPCODE which specifies the instruction type and one or more operands which further specify the operation of the instruction. The PIC16CXX instruction set summary in Table 14-2 lists **byte-oriented**, **bit-oriented**, and **literal and control** operations. Table 14-1 shows the opcode field descriptions.

For **byte-oriented** instructions, 'f' represents a file register designator and 'd' represents a destination designator. The file register designator specifies which file register is to be used by the instruction.

The destination designator specifies where the result of the operation is to be placed. If 'd' is zero, the result is placed in the W register. If 'd' is one, the result is placed in the file register specified in the instruction.

For **bit-oriented** instructions, 'b' represents a bit field designator which selects the number of the bit affected by the operation, while 'f' represents the number of the file in which the bit is located.

For **literal and control** operations, 'k' represents an eight or eleven bit constant or literal value.

TABLE 14-1: OPCODE FIELD DESCRIPTIONS

Field	Description
f	Register file address (0x00 to 0x7F)
W	Working register (accumulator)
b	Bit address within an 8-bit file register
k	Literal field, constant data or label
x	Don't care location (= 0 or 1) The assembler will generate code with x = 0. It is the recommended form of use for compatibility with all Microchip software tools.
d	Destination select; d = 0: store result in W, d = 1: store result in file register f. Default is d = 1
label	Label name
TOS	Top of Stack
PC	Program Counter
PCLATH	Program Counter High Latch
GIE	Global Interrupt Enable bit
WDT	Watchdog Timer/Counter
TO	Time-out bit
PD	Power-down bit
dest	Destination either the W register or the specified register file location
[]	Options
()	Contents
→	Assigned to
< >	Register bit field
∈	In the set of
<i>italics</i>	User defined term (font is courier)

The instruction set is highly orthogonal and is grouped into three basic categories:

- **Byte-oriented** operations
- **Bit-oriented** operations
- **Literal and control** operations

All instructions are executed within one single instruction cycle, unless a conditional test is true or the program counter is changed as a result of an instruction. In this case, the execution takes two instruction cycles with the second cycle executed as a NOP. One instruction cycle consists of four oscillator periods. Thus, for an oscillator frequency of 4 MHz, the normal instruction execution time is 1 μs. If a conditional test is true or the program counter is changed as a result of an instruction, the instruction execution time is 2 μs.

Table 14-2 lists the instructions recognized by the MPASM assembler.

Figure 14-1 shows the general formats that the instructions can have.

Note: To maintain upward compatibility with future PIC16CXX products, do not use the `OPTION` and `TRIS` instructions.

All examples use the following format to represent a hexadecimal number:

0xhh

where h signifies a hexadecimal digit.

FIGURE 14-1: GENERAL FORMAT FOR INSTRUCTIONS



PIC16C6X

TABLE 14-2: PIC16CXX INSTRUCTION SET

Mnemonic, Operands	Description	Cycles	14-Bit Opcode		Status Affected	Notes
			MSb	LSb		
BYTE-ORIENTED FILE REGISTER OPERATIONS						
ADDWF f, d	Add W and f	1	00	0111 dfff ffff	C,DC,Z	1,2
ANDWF f, d	AND W with f	1	00	0101 dfff ffff	Z	1,2
CLRF f	Clear f	1	00	0001 1fff ffff	Z	2
CLRWF -	Clear W	1	00	0001 0xxx xxxx	Z	
COMF f, d	Complement f	1	00	1001 dfff ffff	Z	1,2
DECf f, d	Decrement f	1	00	0011 dfff ffff	Z	1,2
DECFSZ f, d	Decrement f, Skip if 0	1(2)	00	1011 dfff ffff		1,2,3
INCF f, d	Increment f	1	00	1010 dfff ffff	Z	1,2
INCFSZ f, d	Increment f, Skip if 0	1(2)	00	1111 dfff ffff		1,2,3
IORWF f, d	Inclusive OR W with f	1	00	0100 dfff ffff	Z	1,2
MOVF f, d	Move f	1	00	1000 dfff ffff	Z	1,2
MOVWF f	Move W to f	1	00	0000 1fff ffff		
NOP -	No Operation	1	00	0000 0xxx 0000		
RLF f, d	Rotate Left f through Carry	1	00	1101 dfff ffff	C	1,2
RRF f, d	Rotate Right f through Carry	1	00	1100 dfff ffff	C	1,2
SUBWF f, d	Subtract W from f	1	00	0010 dfff ffff	C,DC,Z	1,2
SWAPF f, d	Swap nibbles in f	1	00	1110 dfff ffff		1,2
XORWF f, d	Exclusive OR W with f	1	00	0110 dfff ffff	Z	1,2
BIT-ORIENTED FILE REGISTER OPERATIONS						
BCF f, b	Bit Clear f	1	01	00bb bfff ffff		1,2
BSF f, b	Bit Set f	1	01	01bb bfff ffff		1,2
BTfSC f, b	Bit Test f, Skip if Clear	1(2)	01	10bb bfff ffff		3
BTfSS f, b	Bit Test f, Skip if Set	1(2)	01	11bb bfff ffff		3
LITERAL AND CONTROL OPERATIONS						
ADDLW k	Add literal and W	1	11	111x kkkk kkkk	C,DC,Z	
ANDLW k	AND literal with W	1	11	1001 kkkk kkkk	Z	
CALL k	Call subroutine	2	10	0kkk kkkk kkkk		
CLRWDt -	Clear Watchdog Timer	1	00	0000 0110 0100	$\overline{TO}, \overline{PD}$	
GOTO k	Go to address	2	10	1kkk kkkk kkkk		
IORLW k	Inclusive OR literal with W	1	11	1000 kkkk kkkk	Z	
MOVLW k	Move literal to W	1	11	00xx kkkk kkkk		
RETFIE -	Return from interrupt	2	00	0000 0000 1001		
RETLW k	Return with literal in W	2	11	01xx kkkk kkkk		
RETURN -	Return from Subroutine	2	00	0000 0000 1000		
SLEEP -	Go into standby mode	1	00	0000 0110 0011	$\overline{TO}, \overline{PD}$	
SUBLW k	Subtract W from literal	1	11	110x kkkk kkkk	C,DC,Z	
XORLW k	Exclusive OR literal with W	1	11	1010 kkkk kkkk	Z	

- Note 1: When an I/O register is modified as a function of itself (e.g., `MOVF PORTB, 1`), the value used will be that value present on the pins themselves. For example, if the data latch is '1' for a pin configured as input and is driven low by an external device, the data will be written back with a '0'.
- 2: If this instruction is executed on the TMR0 register (and, where applicable, d = 1), the prescaler will be cleared if assigned to the Timer0 Module.
- 3: If Program Counter (PC) is modified or a conditional test is true, the instruction requires two cycles. The second cycle is executed as a NOP.

14.1 Instruction Descriptions

ADDLW **Add Literal and W**

Syntax: *[label]* ADDLW *k*

Operands: $0 \leq k \leq 255$

Operation: $(W) + k \rightarrow (W)$

Status Affected: C, DC, Z

Encoding:

11	111x	kkkk	kkkk
----	------	------	------

Description: The contents of the W register are added to the eight bit literal 'k' and the result is placed in the W register.

Words: 1

Cycles: 1

Q Cycle Activity:

Q1	Q2	Q3	Q4
Decode	Read literal 'k'	Process data	Write to W

Example: `ADDLW 0x15`

Before Instruction
 W = 0x10

After Instruction
 W = 0x25

ADDWF **Add W and f**

Syntax: *[label]* ADDWF *f,d*

Operands: $0 \leq f \leq 127$
 $d \in [0,1]$

Operation: $(W) + (f) \rightarrow (\text{destination})$

Status Affected: C, DC, Z

Encoding:

00	0111	dfff	ffff
----	------	------	------

Description: Add the contents of the W register with register 'f'. If 'd' is 0 the result is stored in the W register. If 'd' is 1 the result is stored back in register 'f'.

Words: 1

Cycles: 1

Q Cycle Activity:

Q1	Q2	Q3	Q4
Decode	Read register 'f'	Process data	Write to destination

Example `ADDWF FSR, 0`

Before Instruction
 W = 0x17
 FSR = 0xC2

After Instruction
 W = 0xD9
 FSR = 0xC2

ANDLW **AND Literal with W**

Syntax: *[label]* ANDLW *k*

Operands: $0 \leq k \leq 255$

Operation: $(W) .\text{AND.} (k) \rightarrow (W)$

Status Affected: Z

Encoding:

11	1001	kkkk	kkkk
----	------	------	------

Description: The contents of W register are AND'ed with the eight bit literal 'k'. The result is placed in the W register.

Words: 1

Cycles: 1

Q Cycle Activity:

Q1	Q2	Q3	Q4
Decode	Read literal 'k'	Process data	Write to W

Example `ANDLW 0x5F`

Before Instruction
 W = 0xA3

After Instruction
 W = 0x03

ANDWF **AND W with f**

Syntax: *[label]* ANDWF *f,d*

Operands: $0 \leq f \leq 127$
 $d \in [0,1]$

Operation: $(W) .\text{AND.} (f) \rightarrow (\text{destination})$

Status Affected: Z

Encoding:

00	0101	dfff	ffff
----	------	------	------

Description: AND the W register with register 'f'. If 'd' is 0 the result is stored in the W register. If 'd' is 1 the result is stored back in register 'f'.

Words: 1

Cycles: 1

Q Cycle Activity:

Q1	Q2	Q3	Q4
Decode	Read register 'f'	Process data	Write to destination

Example `ANDWF FSR, 1`

Before Instruction
 W = 0x17
 FSR = 0xC2

After Instruction
 W = 0x17
 FSR = 0x02

PIC16C6X

BCF	Bit Clear f								
Syntax:	<code>[label] BCF f,b</code>								
Operands:	$0 \leq f \leq 127$ $0 \leq b \leq 7$								
Operation:	$0 \rightarrow (f)$								
Status Affected:	None								
Encoding:	<table border="1"> <tr> <td>01</td> <td>00bb</td> <td>bfff</td> <td>ffff</td> </tr> </table>	01	00bb	bfff	ffff				
01	00bb	bfff	ffff						
Description:	Bit 'b' in register 'f' is cleared.								
Words:	1								
Cycles:	1								
Q Cycle Activity:	<table border="1"> <tr> <th>Q1</th> <th>Q2</th> <th>Q3</th> <th>Q4</th> </tr> <tr> <td>Decode</td> <td>Read register 'f'</td> <td>Process data</td> <td>Write register 'f'</td> </tr> </table>	Q1	Q2	Q3	Q4	Decode	Read register 'f'	Process data	Write register 'f'
Q1	Q2	Q3	Q4						
Decode	Read register 'f'	Process data	Write register 'f'						

Example `BCF FLAG_REG, 7`

Before Instruction
`FLAG_REG = 0xC7`
 After Instruction
`FLAG_REG = 0x47`

BSF	Bit Set f								
Syntax:	<code>[label] BSF f,b</code>								
Operands:	$0 \leq f \leq 127$ $0 \leq b \leq 7$								
Operation:	$1 \rightarrow (f)$								
Status Affected:	None								
Encoding:	<table border="1"> <tr> <td>01</td> <td>01bb</td> <td>bfff</td> <td>ffff</td> </tr> </table>	01	01bb	bfff	ffff				
01	01bb	bfff	ffff						
Description:	Bit 'b' in register 'f' is set.								
Words:	1								
Cycles:	1								
Q Cycle Activity:	<table border="1"> <tr> <th>Q1</th> <th>Q2</th> <th>Q3</th> <th>Q4</th> </tr> <tr> <td>Decode</td> <td>Read register 'f'</td> <td>Process data</td> <td>Write register 'f'</td> </tr> </table>	Q1	Q2	Q3	Q4	Decode	Read register 'f'	Process data	Write register 'f'
Q1	Q2	Q3	Q4						
Decode	Read register 'f'	Process data	Write register 'f'						

Example `BSF FLAG_REG, 7`

Before Instruction
`FLAG_REG = 0x0A`
 After Instruction
`FLAG_REG = 0x8A`

BTFSC	Bit Test, Skip if Clear								
Syntax:	<code>[label] BTFSC f,b</code>								
Operands:	$0 \leq f \leq 127$ $0 \leq b \leq 7$								
Operation:	skip if $(f) = 0$								
Status Affected:	None								
Encoding:	<table border="1"> <tr> <td>01</td> <td>10bb</td> <td>bfff</td> <td>ffff</td> </tr> </table>	01	10bb	bfff	ffff				
01	10bb	bfff	ffff						
Description:	If bit 'b' in register 'f' is '1' then the next instruction is executed. If bit 'b', in register 'f', is '0' then the next instruction is discarded, and a NOP is executed instead, making this a 2TCY instruction.								
Words:	1								
Cycles:	1(2)								
Q Cycle Activity:	<table border="1"> <tr> <th>Q1</th> <th>Q2</th> <th>Q3</th> <th>Q4</th> </tr> <tr> <td>Decode</td> <td>Read register 'f'</td> <td>Process data</td> <td>No-Operation</td> </tr> </table>	Q1	Q2	Q3	Q4	Decode	Read register 'f'	Process data	No-Operation
Q1	Q2	Q3	Q4						
Decode	Read register 'f'	Process data	No-Operation						

If Skip: (2nd Cycle)

Q1	Q2	Q3	Q4
No-Operation	No-Operation	No-Operation	No-Operation

Example

```

HERE    BTFSC  FLAG, 1
FALSE   GOTO  PROCESS_CODE
TRUE    •
        •
        •
  
```

Before Instruction
`PC = address HERE`
 After Instruction
 if `FLAG<1> = 0,`
`PC = address TRUE`
 if `FLAG<1> = 1,`
`PC = address FALSE`

BTFSS Bit Test f, Skip if Set

Syntax: `[label] BTFSS f,b`

Operands: $0 \leq f \leq 127$
 $0 \leq b < 7$

Operation: skip if $(f < b) = 1$

Status Affected: None

Encoding:

01	11bb	bfff	ffff
----	------	------	------

Description: If bit 'b' in register 'f' is '0' then the next instruction is executed. If bit 'b' is '1', then the next instruction is discarded and a NOP is executed instead, making this a 2TCY instruction.

Words: 1

Cycles: 1(2)

Q Cycle Activity:

Q1	Q2	Q3	Q4
Decode	Read register 'f'	Process data	No-Operation

If Skip: (2nd Cycle)

Q1	Q2	Q3	Q4
No-Operation	No-Operation	No-Operation	No-Operation

Example

```

HERE   BTFSC  FLAG, 1
FALSE  GOTO  PROCESS_CODE
TRUE   •
       •
       •
    
```

Before Instruction

PC = address HERE

After Instruction

```

if FLAG<1> = 0,
PC = address FALSE
if FLAG<1> = 1,
PC = address TRUE
    
```

CALL Call Subroutine

Syntax: `[label] CALL k`

Operands: $0 \leq k \leq 2047$

Operation: $(PC)+1 \rightarrow TOS,$
 $k \rightarrow PC<10:0>,$
 $(PCLATH<4:3>) \rightarrow PC<12:11>$

Status Affected: None

Encoding:

10	0kkk	kkkk	kkkk
----	------	------	------

Description: Call Subroutine. First, return address (PC+1) is pushed onto the stack. The eleven bit immediate address is loaded into PC bits <10:0>. The upper bits of the PC are loaded from PCLATH. CALL is a two cycle instruction.

Words: 1

Cycles: 2

Q Cycle Activity:

Q1	Q2	Q3	Q4
Decode	Read literal 'k', Push PC to Stack	Process data	Write to PC
1st Cycle			
No-Operation	No-Operation	No-Operation	No-Operation
2nd Cycle			

Example

```

HERE   CALL  THERE
    
```

Before Instruction

PC = Address HERE

After Instruction

PC = Address THERE

TOS = Address HERE+1

PIC16C6X

CLRF Clear f

Syntax: [label] CLRF f

Operands: $0 \leq f \leq 127$

Operation: 00h → (f)
1 → Z

Status Affected: Z

Encoding:

00	0001	1fff	ffff
----	------	------	------

Description: The contents of register 'f' are cleared and the Z bit is set.

Words: 1

Cycles: 1

Q Cycle Activity:

Q1	Q2	Q3	Q4
Decode	Read register 'f'	Process data	Write register 'f'

Example

```

CLRF    FLAG_REG
Before Instruction
    FLAG_REG = 0x5A
After Instruction
    FLAG_REG = 0x00
    Z        = 1
    
```

CLRW Clear W

Syntax: [label] CLRW

Operands: None

Operation: 00h → (W)
1 → Z

Status Affected: Z

Encoding:

00	0001	0xxx	xxxx
----	------	------	------

Description: W register is cleared. Zero bit (Z) is set.

Words: 1

Cycles: 1

Q Cycle Activity:

Q1	Q2	Q3	Q4
Decode	No-Operation	Process data	Write to W

Example

```

CLRW
Before Instruction
    W = 0x5A
After Instruction
    W = 0x00
    Z = 1
    
```

CLRWDT Clear Watchdog Timer

Syntax: [label] CLRWDT

Operands: None

Operation: 00h → WDT
0 → WDT prescaler,
1 → \overline{TO}
1 → \overline{PD}

Status Affected: \overline{TO} , \overline{PD}

Encoding:

00	0000	0110	0100
----	------	------	------

Description: CLRWDT instruction resets the Watchdog Timer. It also resets the prescaler of the WDT. Status bits \overline{TO} and \overline{PD} are set.

Words: 1

Cycles: 1

Q Cycle Activity:

Q1	Q2	Q3	Q4
Decode	No-Operation	Process data	Clear WDT Counter

Example

```

CLRWDT
Before Instruction
    WDT counter = ?
After Instruction
    WDT counter = 0x00
    WDT prescaler = 0
     $\overline{TO}$  = 1
     $\overline{PD}$  = 1
    
```

COMF Complement f

Syntax: [label] COMF f,d
 Operands: $0 \leq f \leq 127$
 $d \in [0,1]$
 Operation: $(\bar{f}) \rightarrow (\text{destination})$
 Status Affected: Z
 Encoding:

00	1001	dfff	ffff
----	------	------	------

 Description: The contents of register 'f' are complemented. If 'd' is 0 the result is stored in W. If 'd' is 1 the result is stored back in register 'f'.
 Words: 1
 Cycles: 1
 Q Cycle Activity:

Q1	Q2	Q3	Q4
Decode	Read register 'f'	Process data	Write to destination

Example

```

COMF    REG1, 0
Before Instruction
REG1    = 0x13
After Instruction
REG1    = 0x13
W       = 0xEC
  
```

DECf Decrement f

Syntax: [label] DECf f,d
 Operands: $0 \leq f \leq 127$
 $d \in [0,1]$
 Operation: $(f) - 1 \rightarrow (\text{destination})$
 Status Affected: Z
 Encoding:

00	0011	dfff	ffff
----	------	------	------

 Description: Decrement register 'f'. If 'd' is 0 the result is stored in the W register. If 'd' is 1 the result is stored back in register 'f'.
 Words: 1
 Cycles: 1
 Q Cycle Activity:

Q1	Q2	Q3	Q4
Decode	Read register 'f'	Process data	Write to destination

Example

```

DECf    CNT, 1
Before Instruction
CNT     = 0x01
Z       = 0
After Instruction
CNT     = 0x00
Z       = 1
  
```

DECFSZ Decrement f, Skip if 0

Syntax: [label] DECFSZ f,d
 Operands: $0 \leq f \leq 127$
 $d \in [0,1]$
 Operation: $(f) - 1 \rightarrow (\text{destination});$
 skip if result = 0
 Status Affected: None
 Encoding:

00	1011	dfff	ffff
----	------	------	------

 Description: The contents of register 'f' are decremented. If 'd' is 0 the result is placed in the W register. If 'd' is 1 the result is placed back in register 'f'. If the result is 1, the next instruction, is executed. If the result is 0, then a NOP is executed instead making it a 2Tcy instruction.
 Words: 1
 Cycles: 1(2)
 Q Cycle Activity:

Q1	Q2	Q3	Q4
Decode	Read register 'f'	Process data	Write to destination

 If Skip: (2nd Cycle)

Q1	Q2	Q3	Q4
No-Operation	No-Operation	No-Operation	No-Operation

Example

```

HERE    DECFSZ  CNT, 1
        GOTO    LOOP
CONTINUE :
        :
        :
Before Instruction
PC      = address HERE
After Instruction
CNT     = CNT - 1
if CNT = 0,
PC      = address CONTINUE
if CNT ≠ 0,
PC      = address HERE+1
  
```

PIC16C6X

GOTO Unconditional Branch

Syntax: [*label*] GOTO *k*
 Operands: $0 \leq k \leq 2047$
 Operation: $k \rightarrow PC<10:0>$
 $PCLATH<4:3> \rightarrow PC<12:11>$

Status Affected: None

Encoding:

10	1kkk	kkkk	kkkk
----	------	------	------

Description: GOTO is an unconditional branch. The eleven bit immediate value is loaded into PC bits <10:0>. The upper bits of PC are loaded from PCLATH<4:3>. GOTO is a two cycle instruction.

Words: 1

Cycles: 2

Q Cycle Activity:	Q1	Q2	Q3	Q4
1st Cycle	Decode	Read literal 'k'	Process data	Write to PC
2nd Cycle	No-Operation	No-Operation	No-Operation	No-Operation

Example

```

GOTO THERE
After Instruction
PC = Address THERE
  
```

INCF Increment f

Syntax: [*label*] INCF *f*,*d*
 Operands: $0 \leq f \leq 127$
 $d \in [0,1]$

Operation: $(f) + 1 \rightarrow (\text{destination})$

Status Affected: Z

Encoding:

00	1010	dfff	ffff
----	------	------	------

Description: The contents of register 'f' are incremented. If 'd' is 0 the result is placed in the W register. If 'd' is 1 the result is placed back in register 'f'.

Words: 1

Cycles: 1

Q Cycle Activity:	Q1	Q2	Q3	Q4
	Decode	Read register 'f'	Process data	Write to destination

Example

```

INCF CNT, 1
  
```

```

Before Instruction
CNT = 0xFF
Z = 0
After Instruction
CNT = 0x00
Z = 1
  
```

INCFSZ Increment f, Skip if 0

Syntax: [label] INCFSZ f,d

Operands: $0 \leq f \leq 127$
 $d \in [0,1]$

Operation: $(f) + 1 \rightarrow (\text{destination})$,
 skip if result = 0

Status Affected: None

Encoding:

00	1111	dfff	ffff
----	------	------	------

Description: The contents of register 'f' are incremented. If 'd' is 0 the result is placed in the W register. If 'd' is 1 the result is placed back in register 'f'. If the result is 1, the next instruction is executed. If the result is 0, a NOP is executed instead making it a 2TCY instruction.

Words: 1

Cycles: 1(2)

Q Cycle Activity:

Q1	Q2	Q3	Q4
Decode	Read register 'f'	Process data	Write to destination

If Skip: (2nd Cycle)

Q1	Q2	Q3	Q4
No-Operation	No-Operation	No-Operation	No-Operation

Example

```

HERE      INCFSZ   CNT, 1
          GOTO     LOOP
CONTINUE  •
          •
          •
    
```

Before Instruction
 PC = address HERE

After Instruction
 CNT = CNT + 1
 if CNT= 0,
 PC = address CONTINUE
 if CNT≠ 0,
 PC = address HERE + 1

IORLW Inclusive OR Literal with W

Syntax: [label] IORLW k

Operands: $0 \leq k \leq 255$
 Operation: $(W) .OR. k \rightarrow (W)$

Status Affected: Z

Encoding:

11	1000	kkkk	kkkk
----	------	------	------

Description: The contents of the W register is OR'ed with the eight bit literal 'k'. The result is placed in the W register.

Words: 1

Cycles: 1

Q Cycle Activity:

Q1	Q2	Q3	Q4
Decode	Read literal 'k'	Process data	Write to W

Example IORLW 0x35

Before Instruction
 W = 0x9A

After Instruction
 W = 0xBF
 Z = 1

PIC16C6X

IORWF Inclusive OR W with f

Syntax: [*label*] IORWF f,d

Operands: $0 \leq f \leq 127$
 $d \in [0,1]$

Operation: (W) .OR. (f) → (destination)

Status Affected: Z

Encoding:

00	0100	dfff	ffff
----	------	------	------

Description: Inclusive OR the W register with register 'f'. If 'd' is 0 the result is placed in the W register. If 'd' is 1 the result is placed back in register 'f'.

Words: 1

Cycles: 1

Q Cycle Activity:

	Q1	Q2	Q3	Q4
Decode	Read register 'f'	Process data	Write to destination	

Example IORWF RESULT, 0

Before Instruction
 RESULT = 0x13
 W = 0x91

After Instruction
 RESULT = 0x13
 W = 0x93
 Z = 1

MOVF Move f

Syntax: [*label*] MOVF f,d

Operands: $0 \leq f \leq 127$
 $d \in [0,1]$

Operation: (f) → (destination)

Status Affected: Z

Encoding:

00	1000	dfff	ffff
----	------	------	------

Description: The contents of register f is moved to a destination dependant upon the status of d. If d = 0, destination is W register. If d = 1, the destination is file register f itself. d = 1 is useful to test a file register since status flag Z is affected.

Words: 1

Cycles: 1

Q Cycle Activity:

	Q1	Q2	Q3	Q4
Decode	Read register 'f'	Process data	Write to destination	

Example MOVF FSR, 0

After Instruction
 W = value in FSR register
 Z = 1

MOVLW Move Literal to W

Syntax: [*label*] MOVLW k

Operands: $0 \leq k \leq 255$

Operation: k → (W)

Status Affected: None

Encoding:

11	00xx	kkkk	kkkk
----	------	------	------

Description: The eight bit literal 'k' is loaded into W register. The don't cares will assemble as 0's.

Words: 1

Cycles: 1

Q Cycle Activity:

	Q1	Q2	Q3	Q4
Decode	Read literal 'k'	Process data	Write to W	

Example MOVLW 0x5A

After Instruction
 W = 0x5A

MOVWF Move W to f

Syntax: [*label*] MOVWF f

Operands: $0 \leq f \leq 127$

Operation: (W) → (f)

Status Affected: None

Encoding:

00	0000	1fff	ffff
----	------	------	------

Description: Move data from W register to register 'f'.

Words: 1

Cycles: 1

Q Cycle Activity:

	Q1	Q2	Q3	Q4
Decode	Read register 'f'	Process data	Write register 'f'	

Example MOVWF OPTION_REG

Before Instruction
 OPTION = 0xFF
 W = 0x4F

After Instruction
 OPTION = 0x4F
 W = 0x4F

NOP **No Operation**

Syntax: [*label*] NOP

Operands: None

Operation: No operation

Status Affected: None

Encoding:

00	0000	0xx0	0000
----	------	------	------

Description: No operation.

Words: 1

Cycles: 1

Q Cycle Activity:

	Q1	Q2	Q3	Q4
	Decode	No-Operation	No-Operation	No-Operation

Example NOP

RETFIE **Return from Interrupt**

Syntax: [*label*] RETFIE

Operands: None

Operation: TOS → PC,
1 → GIE

Status Affected: None

Encoding:

00	0000	0000	1001
----	------	------	------

Description: Return from Interrupt. Stack is POPed and Top of Stack (TOS) is loaded in the PC. Interrupts are enabled by setting Global Interrupt Enable bit, GIE (INTCON<7>). This is a two cycle instruction.

Words: 1

Cycles: 2

Q Cycle Activity:

	Q1	Q2	Q3	Q4
1st Cycle	Decode	No-Operation	Set the GIE bit	Pop from the Stack
2nd Cycle	No-Operation	No-Operation	No-Operation	No-Operation

Example RETFIE

After Interrupt

PC = TOS

GIE = 1

OPTION	Load Option Register				
Syntax:	[<i>label</i>] OPTION				
Operands:	None				
Operation:	(W) → OPTION				
Status Affected:	None				
Encoding:	<table border="1" style="display: inline-table;"><tr><td>00</td><td>0000</td><td>0110</td><td>0010</td></tr></table>	00	0000	0110	0010
00	0000	0110	0010		
Description:	The contents of the W register are loaded in the OPTION register. This instruction is supported for code compatibility with PIC16C5X products. Since OPTION is a readable/writable register, the user can directly address it.				
Words:	1				
Cycles:	1				
Example	<div style="border: 1px solid black; padding: 5px; margin-top: 10px;">To maintain upward compatibility with future PIC16CXX products, do not use this instruction.</div>				

PIC16C6X

RETLW Return with Literal in W

Syntax: [label] RETLW k

Operands: $0 \leq k \leq 255$

Operation: $k \rightarrow (W)$;
TOS \rightarrow PC

Status Affected: None

Encoding:

11	01xx	kkkk	kkkk
----	------	------	------

Description: The W register is loaded with the eight bit literal 'k'. The program counter is loaded from the top of the stack (the return address). This is a two cycle instruction.

Words: 1

Cycles: 2

Q Cycle Activity:	Q1	Q2	Q3	Q4
1st Cycle	Decode	Read literal 'k'	No-Operation	Write to W, Pop from the Stack
2nd Cycle	No-Operation	No-Operation	No-Operation	No-Operation

Example

```
CALL TABLE ;W contains table
              ;offset value
              ;W now has table value
•
•
•
TABLE ADDWF PC ;W = offset
      RETLW k1 ;Begin table
      RETLW k2 ;
      •
      •
      RETLW kn ; End of table
```

Before Instruction

W = 0x07

After Instruction

W = value of k8

RETURN Return from Subroutine

Syntax: [label] RETURN

Operands: None

Operation: TOS \rightarrow PC

Status Affected: None

Encoding:

00	0000	0000	1000
----	------	------	------

Description: Return from subroutine. The stack is POPed and the top of the stack (TOS) is loaded into the program counter. This is a two cycle instruction.

Words: 1

Cycles: 2

Q Cycle Activity:	Q1	Q2	Q3	Q4
1st Cycle	Decode	No-Operation	No-Operation	Pop from the Stack
2nd Cycle	No-Operation	No-Operation	No-Operation	No-Operation

Example

```
RETURN
After Interrupt
      PC = TOS
```

RLF Rotate Left f through Carry

Syntax: [label] RLF f,d
Operands: $0 \leq f \leq 127$
 $d \in [0,1]$
Operation: See description below
Status Affected: C
Encoding:

00	1101	dfff	ffff
----	------	------	------

Description: The contents of register 'f' are rotated one bit to the left through the Carry Flag. If 'd' is 0 the result is placed in the W register. If 'd' is 1 the result is stored back in register 'f'.



Words: 1
Cycles: 1
Q Cycle Activity:

Q1	Q2	Q3	Q4
Decode	Read register 'f'	Process data	Write to destination

Example RLF REG1,0

Before Instruction

```
REG1 = 1110 0110
C     = 0
```

After Instruction

```
REG1 = 1110 0110
W     = 1100 1100
C     = 1
```

RRF Rotate Right f through Carry

Syntax: [label] RRF f,d
Operands: $0 \leq f \leq 127$
 $d \in [0,1]$
Operation: See description below
Status Affected: C
Encoding:

00	1100	dfff	ffff
----	------	------	------

Description: The contents of register 'f' are rotated one bit to the right through the Carry Flag. If 'd' is 0 the result is placed in the W register. If 'd' is 1 the result is placed back in register 'f'.

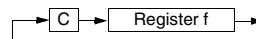

Words: 1
Cycles: 1
Q Cycle Activity:

Q1	Q2	Q3	Q4
Decode	Read register 'f'	Process data	Write to destination

Example RRF REG1,0

Before Instruction

```
REG1 = 1110 0110
C     = 0
```

After Instruction

```
REG1 = 1110 0110
W     = 0111 0011
C     = 0
```

PIC16C6X

SLEEP

Syntax: [*label*] SLEEP

Operands: None

Operation: 00h → WDT,
0 → WDT prescaler,
1 → \overline{TO} ,
0 → \overline{PD}

Status Affected: \overline{TO} , \overline{PD}

Encoding:

00	0000	0110	0011
----	------	------	------

Description: The power-down status bit, \overline{PD} is cleared. Time-out status bit, \overline{TO} is set. Watchdog Timer and its prescaler are cleared. The processor is put into SLEEP mode with the oscillator stopped. See Section 13.8 for more details.

Words: 1

Cycles: 1

Q Cycle Activity:

	Q1	Q2	Q3	Q4
Decode	No-Operation	No-Operation	Go to Sleep	

Example: SLEEP

SUBLW

Subtract W from Literal

Syntax: [*label*] SUBLW k

Operands: $0 \leq k \leq 255$

Operation: $k - (W) \rightarrow (W)$

Status Affected: C, DC, Z

Encoding:

11	110x	kkkk	kkkk
----	------	------	------

Description: The W register is subtracted (2's complement method) from the eight bit literal 'k'. The result is placed in the W register.

Words: 1

Cycles: 1

Q Cycle Activity:

	Q1	Q2	Q3	Q4
Decode	Read literal 'k'	Process data	Write to W	

Example 1: SUBLW 0x02

Before Instruction

W = 1
C = ?
Z = ?

After Instruction

W = 1
C = 1; result is positive
Z = 0

Example 2: Before Instruction

W = 2
C = ?
Z = ?

After Instruction

W = 0
C = 1; result is zero
Z = 1

Example 3: Before Instruction

W = 3
C = ?
Z = ?

After Instruction

W = 0xFF
C = 0; result is negative
Z = 0

SUBWF Subtract W from f

Syntax: [label] SUBWF f,d

Operands: $0 \leq f \leq 127$
 $d \in [0,1]$

Operation: $(f) - (W) \rightarrow (\text{destination})$

Status Affected: C, DC, Z

Encoding:

00	0010	dfff	ffff
----	------	------	------

Description: Subtract (2's complement method) W register from register 'f'. If 'd' is 0 the result is stored in the W register. If 'd' is 1 the result is stored back in register 'f'.

Words: 1

Cycles: 1

Q Cycle Activity:

Q1	Q2	Q3	Q4
Decode	Read register 'f'	Process data	Write to destination

Example 1: SUBWF REG1, 1

Before Instruction

```
REG1 = 3
W     = 2
C     = ?
Z     = ?
```

After Instruction

```
REG1 = 1
W     = 2
C     = 1; result is positive
Z     = 0
```

Example 2: Before Instruction

```
REG1 = 2
W     = 2
C     = ?
Z     = ?
```

After Instruction

```
REG1 = 0
W     = 2
C     = 1; result is zero
Z     = 1
```

Example 3: Before Instruction

```
REG1 = 1
W     = 2
C     = ?
Z     = ?
```

After Instruction

```
REG1 = 0xFF
W     = 2
C     = 0; result is negative
Z     = 0
```

SWAPF Swap Nibbles in f

Syntax: [label] SWAPF f,d

Operands: $0 \leq f \leq 127$
 $d \in [0,1]$

Operation: $(f<3:0>) \rightarrow (\text{destination}<7:4>)$,
 $(f<7:4>) \rightarrow (\text{destination}<3:0>)$

Status Affected: None

Encoding:

00	1110	dfff	ffff
----	------	------	------

Description: The upper and lower nibbles of register 'f' are exchanged. If 'd' is 0 the result is placed in W register. If 'd' is 1 the result is placed in register 'f'.

Words: 1

Cycles: 1

Q Cycle Activity:

Q1	Q2	Q3	Q4
Decode	Read register 'f'	Process data	Write to destination

Example SWAPF REG, 0

Before Instruction

```
REG1 = 0xA5
```

After Instruction

```
REG1 = 0x5A
W     = 0x5A
```

TRIS Load TRIS Register

Syntax: [label] TRIS f

Operands: $5 \leq f \leq 7$

Operation: $(W) \rightarrow \text{TRIS register } f$;

Status Affected: None

Encoding:

00	0000	0110	0fff
----	------	------	------

Description: The instruction is supported for code compatibility with the PIC16C5X products. Since TRIS registers are readable and writable, the user can directly address them.

Words: 1

Cycles: 1

Example

To maintain upward compatibility with future PIC16CXX products, do not use this instruction.

PIC16C6X

XORLW Exclusive OR Literal with W

Syntax: `[label] XORLW k`

Operands: $0 \leq k \leq 255$

Operation: $(W) \text{ .XOR. } k \rightarrow (W)$

Status Affected: Z

Encoding:

11	1010	kkkk	kkkk
----	------	------	------

Description: The contents of the W register are XOR'ed with the eight bit literal 'k'. The result is placed in the W register.

Words: 1

Cycles: 1

Q Cycle Activity:

Q1	Q2	Q3	Q4
Decode	Read literal 'k'	Process data	Write to W

Example:

```
XORLW 0xAF
Before Instruction
    W = 0xB5
After Instruction
    W = 0x1A
```

XORWF Exclusive OR W with f

Syntax: `[label] XORWF f,d`

Operands: $0 \leq f \leq 127$
 $d \in [0,1]$

Operation: $(W) \text{ .XOR. } (f) \rightarrow (\text{destination})$

Status Affected: Z

Encoding:

00	0110	dfff	ffff
----	------	------	------

Description: Exclusive OR the contents of the W register with register 'f'. If 'd' is 0 the result is stored in the W register. If 'd' is 1 the result is stored back in register 'f'.

Words: 1

Cycles: 1

Q Cycle Activity:

Q1	Q2	Q3	Q4
Decode	Read register 'f'	Process data	Write to destination

Example

```
XORWF REG 1
Before Instruction
    REG = 0xAF
    W   = 0xB5
After Instruction
    REG = 0x1A
    W   = 0xB5
```

15.0 ELECTRICAL CHARACTERISTICS FOR PIC16C61

Absolute Maximum Ratings †

Ambient temperature under bias.....	-55°C to +125°C
Storage temperature.....	-65°C to +150°C
Voltage on any pin with respect to V _{SS} (except V _{DD} , $\overline{\text{MCLR}}$, and RA4).....	-0.3V to (V _{DD} + 0.3V)
Voltage on V _{DD} with respect to V _{SS}	-0.3V to +7.5V
Voltage on $\overline{\text{MCLR}}$ with respect to V _{SS} (Note 2).....	0V to +14V
Voltage on RA4 pin with respect to V _{SS}	0V to +14V
Total power dissipation (Note 1).....	800 mW
Maximum current out of V _{SS} pin.....	150 mA
Maximum current into V _{DD} pin.....	100 mA
Input clamp current, I _{IK} (V _I < 0 or V _I > V _{DD}).....	± 20 mA
Output clamp current, I _{OK} (V _O < 0 or V _O > V _{DD}).....	± 20 mA
Maximum output current sunk by any I/O pin.....	25 mA
Maximum output current sourced by any I/O pin.....	20 mA
Maximum current sunk by PORTA.....	80 mA
Maximum current sourced by PORTA.....	50 mA
Maximum current sunk by PORTB.....	150 mA
Maximum current sourced by PORTB.....	100 mA

Note 1: Power dissipation is calculated as follows: $P_{dis} = V_{DD} \times \{I_{DD} - \sum I_{OH}\} + \sum \{(V_{DD} - V_{OH}) \times I_{OH}\} + \sum (V_{OL} \times I_{OL})$

Note 2: Voltage spikes below V_{SS} at the $\overline{\text{MCLR}}$ pin, inducing currents greater than 80 mA, may cause latch-up. Thus, a series resistor of 50-100Ω should be used when applying a “low” level to the $\overline{\text{MCLR}}$ pin rather than pulling this pin directly to V_{SS}.

† NOTICE: Stresses above those listed under “Absolute Maximum Ratings” may cause permanent damage to the device. This is a stress rating only and functional operation of the device at those or any other conditions above those indicated in the operation listings of this specification is not implied. Exposure to maximum rating conditions for extended periods may affect device reliability.

TABLE 15-1: CROSS REFERENCE OF DEVICE SPECS FOR OSCILLATOR CONFIGURATIONS AND FREQUENCIES OF OPERATION (COMMERCIAL DEVICES)

OSC	PIC16C61-04	PIC16C61-20	PIC16LC61-04	JW Devices
RC	V _{DD} : 4.0V to 6.0V I _{DD} : 3.3 mA max. at 5.5V I _{PD} : 14 μA max. at 4V Freq: 4 MHz max.	V _{DD} : 4.5V to 5.5V I _{DD} : 1.8 mA typ. at 5.5V I _{PD} : 1.0 μA typ. at 4V Freq: 4 MHz max.	V _{DD} : 3.0V to 6.0V I _{DD} : 1.4 mA typ. at 3.0V I _{PD} : 0.6 μA typ. at 3V Freq: 4 MHz max.	V _{DD} : 4.0V to 6.0V I _{DD} : 3.3 mA max. at 5.5V I _{PD} : 14 μA max. at 4V Freq: 4 MHz max.
XT	V _{DD} : 4.0V to 6.0V I _{DD} : 3.3 mA max. at 5.5V I _{PD} : 14 μA max. at 4V Freq: 4 MHz max.	V _{DD} : 4.5V to 5.5V I _{DD} : 1.8 mA typ. at 5.5V I _{PD} : 1.0 μA typ. at 4V Freq: 4 MHz max.	V _{DD} : 3.0V to 6.0V I _{DD} : 1.4 mA typ. at 3.0V I _{PD} : 0.6 μA typ. at 3V Freq: 4 MHz max.	V _{DD} : 4.0V to 6.0V I _{DD} : 3.3 mA max. at 5.5V I _{PD} : 14 μA max. at 4V Freq: 4 MHz max.
HS	V _{DD} : 4.5V to 5.5V I _{DD} : 13.5 mA typ. at 5.5V I _{PD} : 1.0 μA typ. at 4.5V Freq: 4 MHz max.	V _{DD} : 4.5V to 5.5V I _{DD} : 30 mA max. at 5.5V I _{PD} : 1.0 μA typ. at 4.5V Freq: 20 MHz max.	Not recommended for use in HS mode	V _{DD} : 4.5V to 5.5V I _{DD} : 30 mA max. at 5.5V I _{PD} : 1.0 μA typ. at 4.5V Freq: 20 MHz max.
LP	V _{DD} : 4.0V to 6.0V I _{DD} : 15 μA typ. at 32 kHz, 4.0V I _{PD} : 0.6 μA typ. at 4.0V Freq: 200 kHz max.	Not recommended for use in LP mode	V _{DD} : 3.0V to 6.0V I _{DD} : 32 μA max. at 32 kHz, 3.0V I _{PD} : 9 μA max. at 3.0V Freq: 200 kHz max.	V _{DD} : 3.0V to 6.0V I _{DD} : 32 μA max. at 32 kHz, 3.0V I _{PD} : 9 μA max. at 3.0V Freq: 200 kHz max.

The shaded sections indicate oscillator selections which are tested for functionality, but not for MIN/MAX specifications. It is recommended that the user select the device type that ensures the specifications required.

PIC16C6X

Applicable Devices 61 62 62A R62 63 R63 64 64A R64 65 65A R65 66 67

15.1 DC Characteristics: PIC16C61-04 (Commercial, Industrial, Extended) PIC16C61-20 (Commercial, Industrial, Extended)

Standard Operating Conditions (unless otherwise stated)							
DC CHARACTERISTICS							
Operating temperature -40°C ≤ TA ≤ +125°C for extended, -40°C ≤ TA ≤ +85°C for industrial and 0°C ≤ TA ≤ +70°C for commercial							
Param No.	Characteristic	Sym	Min	Typ†	Max	Units	Conditions
D001 D001A	Supply Voltage	VDD	4.0 4.5	- -	6.0 5.5	V V	XT, RC and LP osc configuration HS osc configuration
D002*	RAM Data Retention Voltage (Note 1)	VDR	-	1.5	-	V	
D003	VDD start voltage to ensure internal Power-on Reset signal	VPOR	-	VSS	-	V	See section on Power-on Reset for details
D004*	VDD rise rate to ensure internal Power-on Reset signal	SVDD	0.05	-	-	V/ms	See section on Power-on Reset for details
D010 D013	Supply Current (Note 2)	IDD	- -	1.8 13.5	3.3 30	mA mA	FOSC = 4 MHz, VDD = 5.5V (Note 4) HS osc configuration FOSC = 20 MHz, VDD = 5.5V
D020 D021 D021A D021B	Power-down Current (Note 3)	IPD	- - - -	7 1.0 1.0 1.0	28 14 16 20	μA μA μA μA	VDD = 4.0V, WDT enabled, -40°C to +85°C VDD = 4.0V, WDT disabled, -0°C to +70°C VDD = 4.0V, WDT disabled, -40°C to +85°C VDD = 4.0V, WDT disabled, -40°C to +125°C

* These parameters are characterized but not tested.

† Data in "Typ" column is at 5V, 25°C unless otherwise stated. These parameters are for design guidance only and are not tested.

Note 1: This is the limit to which VDD can be lowered without losing RAM data.

2: The supply current is mainly a function of the operating voltage and frequency. Other factors such as I/O pin loading and switching rate, oscillator type, internal code execution pattern, and temperature also have an impact on the current consumption.

The test conditions for all IDD measurements in active operation mode are:
OSC1 = external square wave, from rail to rail; all I/O pins tristated, pulled to VDD,
MCLR = VDD; WDT enabled/disabled as specified.

3: The power-down current in SLEEP mode does not depend on the oscillator type. Power-down current is measured with the part in SLEEP mode, with all I/O pins in hi-impedance state and tied to VDD and VSS.

4: For RC osc configuration, current through Rext is not included. The current through the resistor can be estimated by the formula $I_r = V_{DD}/2R_{ext}$ (mA) with Rext in kOhm.

15.2 DC Characteristics: PIC16LC61-04 (Commercial, Industrial)

DC CHARACTERISTICS		Standard Operating Conditions (unless otherwise stated)						Conditions
Param No.	Characteristic	Sym	Min	Typ†	Max	Units		
D001	Supply Voltage	VDD	3.0	-	6.0	V	XT, RC, and LP osc configuration	
D002*	RAM Data Retention Voltage (Note 1)	VDR	-	1.5	-	V		
D003	VDD start voltage to ensure internal Power-on Reset signal	VPOR	-	VSS	-	V	See section on Power-on Reset for details	
D004*	VDD rise rate to ensure internal Power-on Reset signal	SVDD	0.05	-	-	V/ms	See section on Power-on Reset for details	
D010	Supply Current (Note 2)	IDD	-	1.4	2.5	mA	FOSC = 4 MHz, VDD = 3.0V (Note 4)	
D010A			-	15	32	μA	FOSC = 32 kHz, VDD = 3.0V, WDT disabled, LP osc configuration	
D020	Power-down Current (Note 3)	IPD	-	5	20	μA	VDD = 3.0V, WDT enabled, -40°C to +85°C	
D021			-	0.6	9	μA	VDD = 3.0V, WDT disabled, 0°C to +70°C	
D021A			-	0.6	12	μA	VDD = 3.0V, WDT disabled, -40°C to +85°C	

* These parameters are characterized but not tested.

† Data in "Typ" column is at 5V, 25°C unless otherwise stated. These parameters are for design guidance only and are not tested.

Note 1: This is the limit to which VDD can be lowered without losing RAM data.

- 2: The supply current is mainly a function of the operating voltage and frequency. Other factors such as I/O pin loading and switching rate, oscillator type, internal code execution pattern, and temperature also have an impact on the current consumption.

The test conditions for all IDD measurements in active operation mode are:

OSC1 = external square wave, from rail to rail; all I/O pins tristated, pulled to VDD,

MCLR = VDD; WDT enabled/disabled as specified.

- 3: The power-down current in SLEEP mode does not depend on the oscillator type. Power-down current is measured with the part in SLEEP mode, with all I/O pins in hi-impedance state and tied to VDD and VSS.
- 4: For RC osc configuration, current through Rext is not included. The current through the resistor can be estimated by the formula $I_r = V_{DD}/2R_{ext}$ (mA) with Rext in kOhm.

PIC16C6X

Applicable Devices 61 62 62A R62 63 R63 64 64A R64 65 65A R65 66 67

15.3 DC Characteristics: PIC16C61-04 (Commercial, Industrial, Extended) PIC16C61-20 (Commercial, Industrial, Extended) PIC16LC61-04 (Commercial, Industrial)

DC CHARACTERISTICS		Standard Operating Conditions (unless otherwise stated)					
		Operating temperature -40°C ≤ TA ≤ +125°C for extended, -40°C ≤ TA ≤ +85°C for industrial and 0°C ≤ TA ≤ +70°C for commercial Operating voltage VDD range as described in DC spec Section 15.1 and Section 15.2.					
Param No.	Characteristic	Sym	Min	Typ†	Max	Units	Conditions
D030 D030A D031 D032 D033	Input Low Voltage I/O ports	VIL					
	with TTL buffer		VSS	-	0.15VDD	V	For entire VDD range
			VSS	-	0.8V	V	4.5V ≤ VDD ≤ 5.5V
	with Schmitt Trigger buffer		VSS	-	0.2VDD	V	
	MCLR, OSC1 (in RC mode)		VSS	-	0.2VDD	V	
D033	OSC1 (in XT, HS and LP)	VSS	-	0.3VDD	V	Note1	
D040 D040A D041 D042 D042A D043	Input High Voltage I/O ports	VIH					
	with TTL buffer		2.0	-	VDD	V	4.5V ≤ VDD ≤ 5.5V
			0.25VDD + 0.8V	-	VDD	V	For entire VDD range
	with Schmitt Trigger buffer		0.85VDD	-	VDD	V	For entire VDD range
	MCLR		0.85VDD	-	VDD	V	
	OSC1 (XT, HS and LP)		0.7VDD	-	VDD	V	Note1
D043	OSC1 (in RC mode)	0.9VDD	-	VDD	V		
D070	PORTB weak pull-up current	IPURB	50	250	† 400	µA	VDD = 5V, VPIN = VSS
D060 D061 D063	Input Leakage Current (Notes 2, 3) I/O ports	IIL					
			-	-	±1	µA	VSS ≤ VPIN ≤ VDD, Pin at hi-impedance
	MCLR, RA4/T0CKI		-	-	±5	µA	VSS ≤ VPIN ≤ VDD
D063	OSC1	-	-	±5	µA	VSS ≤ VPIN ≤ VDD, XT, HS and LP osc configuration	
D080 D080A D083 D083A	Output Low Voltage I/O ports	VOL					
			-	-	0.6	V	IOI = 8.5 mA, VDD = 4.5V, -40°C to +85°C
			-	-	0.6	V	IOI = 7.0 mA, VDD = 4.5V, -40°C to +125°C
	OSC2/CLKOUT (RC osc config)		-	-	0.6	V	IOI = 1.6 mA, VDD = 4.5V, -40°C to +85°C
D083A		-	-	0.6	V	IOI = 1.2 mA, VDD = 4.5V, -40°C to +125°C	

* The parameters are characterized but not tested.

† Data in "Typ" column is at 5V, 25°C unless otherwise stated. These parameters are for design guidance only and are not tested.

Note 1: In RC oscillator configuration, the OSC1/CLKIN pin is a Schmitt Trigger input. It is not recommended that the PIC16C6X be driven with external clock in RC mode.

2: The leakage current on the MCLR/VPP pin is strongly dependent on the applied voltage level. The specified levels represent normal operating conditions. Higher leakage current may be measured at different input voltages.

3: Negative current is defined as current sourced by the pin.

PIC16C6X

Applicable Devices 61 62 62A R62 63 R63 64 64A R64 65 65A R65 66 67

DC CHARACTERISTICS							
Standard Operating Conditions (unless otherwise stated)							
Operating temperature -40°C ≤ TA ≤ +125°C for extended, -40°C ≤ TA ≤ +85°C for industrial and 0°C ≤ TA ≤ +70°C for commercial							
Operating voltage VDD range as described in DC spec Section 15.1 and Section 15.2.							
Param No.	Characteristic	Sym	Min	Typ†	Max	Units	Conditions
D090	Output High Voltage I/O ports (Note 3)	VOH	VDD-0.7	-	-	V	IOH = -3.0 mA, VDD = 4.5V, -40°C to +85°C
D090A			VDD-0.7	-	-	V	IOH = -2.5 mA, VDD = 4.5V, -40°C to +125°C
D092	OSC2/CLKOUT (RC osc config)		VDD-0.7	-	-	V	IOH = -1.3 mA, VDD = 4.5V, -40°C to +85°C
D092A			VDD-0.7	-	-	V	IOH = -1.0 mA, VDD = 4.5V, -40°C to +125°C
D150*	Open-Drain High Voltage	VOD	-	-	14	V	RA4 pin
Capacitive Loading Specs on Output Pins							
D100	OSC2 pin	Cosc2			15	pF	In XT, HS and LP modes when external clock is used to drive OSC1.
D101	All I/O pins and OSC2 (in RC mode)	CIO			50	pF	

* The parameters are characterized but not tested.

† Data in "Typ" column is at 5V, 25°C unless otherwise stated. These parameters are for design guidance only and are not tested.

- Note 1: In RC oscillator configuration, the OSC1/CLKIN pin is a Schmitt Trigger input. It is not recommended that the PIC16C6X be driven with external clock in RC mode.
- 2: The leakage current on the MCLR/VPP pin is strongly dependent on the applied voltage level. The specified levels represent normal operating conditions. Higher leakage current may be measured at different input voltages.
- 3: Negative current is defined as current sourced by the pin.

PIC16C6X

Applicable Devices 61 62 62A R62 63 R63 64 64A R64 65 65A R65 66 67

15.4 Timing Parameter Symbology

The timing parameter symbols have been created following one of the following formats:

1. TppS2ppS
2. TppS
3. TCC:ST (I²C specifications only)
4. Ts (I²C specifications only)

T			
F	Frequency	T	Time

Lowercase letters (pp) and their meanings:

pp			
cc	CCP1	osc	OSC1
ck	CLKOUT	rd	\overline{RD}
cs	\overline{CS}	rw	\overline{RD} or \overline{WR}
di	SDI	sc	SCK
do	SDO	ss	\overline{SS}
dt	Data in	t0	T0CKI
io	I/O port	t1	T1CKI
mc	\overline{MCLR}	wr	\overline{WR}

Uppercase letters and their meanings:

S			
F	Fall	P	Period
H	High	R	Rise
I	Invalid (Hi-impedance)	V	Valid
L	Low	Z	Hi-impedance
I²C only			
AA	output access	High	High
BUF	Bus free	Low	Low

TCC:ST (I²C specifications only)

CC			
HD	Hold	SU	Setup
ST			
DAT	DATA input hold	STO	STOP condition
STA	START condition		

FIGURE 15-1: LOAD CONDITIONS FOR DEVICE TIMING SPECIFICATIONS



15.5 Timing Diagrams and Specifications

FIGURE 15-2: EXTERNAL CLOCK TIMING



TABLE 15-2: EXTERNAL CLOCK TIMING REQUIREMENTS

Parameter No.	Sym	Characteristic	Min	Typ†	Max	Units	Conditions	
	Fosc	External CLKIN Frequency (Note 1)	DC	—	4	MHz	XT and RC osc mode	
			DC	—	4	MHz	HS osc mode (-04)	
			DC	—	20	MHz	HS osc mode (-20)	
			DC	—	200	kHz	LP osc mode	
			Oscillator Frequency (Note 1)	DC	—	4	MHz	RC osc mode
				0.1	—	4	MHz	XT osc mode
				1	—	4	MHz	HS osc mode (-04)
				1	—	20	MHz	HS osc mode (-20)
1	Tosc	External CLKIN Period (Note 1)	250	—	—	ns	XT and RC osc mode	
			250	—	—	ns	HS osc mode (-04)	
			50	—	—	ns	HS osc mode (-20)	
			5	—	—	μs	LP osc mode	
			Oscillator Period (Note 1)	250	—	—	ns	RC osc mode
				250	—	10,000	ns	XT osc mode
				250	—	1,000	ns	HS osc mode (-04)
				50	—	1,000	ns	HS osc mode (-20)
			5	—	—	μs	LP osc mode	
2	T _{CY}	Instruction Cycle Time (Note 1)	1.0	T _{CY}	DC	μs	T _{CY} = 4/Fosc	
3	TosL, TosH	External Clock in (OSC1) High or Low Time	50	—	—	ns	XT oscillator	
			2.5	—	—	μs	LP oscillator	
			10	—	—	ns	HS oscillator	
4	TosR, TosF	External Clock in (OSC1) Rise or Fall Time	25	—	—	ns	XT oscillator	
			50	—	—	ns	LP oscillator	
			15	—	—	ns	HS oscillator	

† Data in "Typ" column is at 5V, 25°C unless otherwise stated. These parameters are for design guidance only and are not tested.

Note 1: Instruction cycle period (T_{CY}) equals four times the input oscillator time-base period. All specified values are based on characterization data for that particular oscillator type under standard operating conditions with the device executing code. Exceeding these specified limits may result in an unstable oscillator operation and/or higher than expected current consumption. All devices are tested to operate at "min." values with an external clock applied to the OSC1/CLKIN pin. When an external clock input is used, the "Max." cycle time limit is "DC" (no clock) for all devices.

PIC16C6X

Applicable Devices 61 62 62A R62 63 R63 64 64A R64 65 65A R65 66 67

FIGURE 15-3: CLKOUT AND I/O TIMING



TABLE 15-3: CLKOUT AND I/O TIMING REQUIREMENTS

Parameter No.	Sym	Characteristic	Min	Typ†	Max	Units	Conditions	
10*	TosH2ckL	OSC1↑ to CLKOUT↓	—	15	30	ns	Note 1	
11*	TosH2ckH	OSC1↑ to CLKOUT↑	—	15	30	ns	Note 1	
12*	TckR	CLKOUT rise time	—	5	15	ns	Note 1	
13*	TckF	CLKOUT fall time	—	5	15	ns	Note 1	
14*	TckL2ioV	CLKOUT ↓ to Port out valid	—	—	0.5TcY + 20	ns	Note 1	
15*	TioV2ckH	Port in valid before CLKOUT ↑	0.25TcY + 25	—	—	ns	Note 1	
16*	TckH2ioI	Port in hold after CLKOUT ↑	0	—	—	ns	Note 1	
17*	TosH2ioV	OSC1↑ (Q1 cycle) to Port out valid	—	—	80 - 100	ns		
18*	TosH2ioI	OSC1↑ (Q2 cycle) to Port input invalid (I/O in hold time)	TBD	—	—	ns		
19*	TioV2osH	Port input valid to OSC1↑ (I/O in setup time)	TBD	—	—	ns		
20*	TioR	Port output rise time	PIC16C61	—	10	25	ns	
			PIC16LC61	—	—	60	ns	
21*	TioF	Port output fall time	PIC16C61	—	10	25	ns	
			PIC16LC61	—	—	60	ns	
22††*	Tinp	RB0/INT pin high or low time	20	—	—	ns		
23††*	Trbp	RB7:RB4 change int high or low time	20	—	—	ns		

* These parameters are characterized but not tested.

† Data in "Typ" column is at 5V, 25°C unless otherwise stated. These parameters are for design guidance only and are not tested.

†† These parameters are asynchronous events not related to any internal clock edges.

Note 1: Measurements are taken in RC Mode where CLKOUT output is 4 x Tosc.

FIGURE 15-4: RESET, WATCHDOG TIMER, OSCILLATOR START-UP TIMER AND POWER-UP TIMER TIMING



TABLE 15-4: RESET, WATCHDOG TIMER, OSCILLATOR START-UP TIMER AND POWER-UP TIMER REQUIREMENTS

Parameter No.	Sym	Characteristic	Min	Typ†	Max	Units	Conditions
30*	Tmcl	MCLR Pulse Width (low)	200	—	—	ns	VDD = 5V, -40°C to +125°C
31*	Twdt	Watchdog Timer Time-out Period (No Prescaler)	7	18	33	ms	VDD = 5V, -40°C to +125°C
32	Tost	Oscillation Start-up Timer Period	—	1024Tosc	—		TOSC = OSC1 period
33*	Tpwrt	Power-up Timer Period	28	72	132	ms	VDD = 5V, -40°C to +125°C
34*	Tioz	I/O Hi-impedance from MCLR Low	—	—	100	ns	

* These parameters are characterized but not tested.

† Data in "Typ" column is at 5V, 25°C unless otherwise stated. These parameters are for design guidance only and are not tested.

PIC16C6X

Applicable Devices 61 62 62A R62 63 R63 64 64A R64 65 65A R65 66 67

FIGURE 15-5: TIMER0 EXTERNAL CLOCK TIMINGS



TABLE 15-5: TIMER0 EXTERNAL CLOCK REQUIREMENTS

Parameter No.	Sym	Characteristic	Min	Typ†	Max	Units	Conditions	
40*	Tt0H	T0CKI High Pulse Width	No Prescaler	$0.5T_{CY} + 20$	—	—	ns	Must also meet parameter 42
			With Prescaler	10	—	—	ns	
41*	Tt0L	T0CKI Low Pulse Width	No Prescaler	$0.5T_{CY} + 20$	—	—	ns	Must also meet parameter 42
			With Prescaler	10	—	—	ns	
42*	Tt0P	T0CKI Period	No Prescaler	$T_{CY} + 40$	—	—	ns	N = prescale value (2, 4, ..., 256)
			With Prescaler	Greater of: 20 ns or $\frac{T_{CY} + 40}{N}$	—	—	ns	

* These parameters are characterized but not tested.

† Data in "Typ" column is at 5V, 25°C unless otherwise stated. These parameters are for design guidance only and are not tested.

16.0 DC AND AC CHARACTERISTICS GRAPHS AND TABLES FOR PIC16C61

The graphs and tables provided in this section are for design guidance and are not tested or guaranteed.

In some graphs or tables the data presented are outside specified operating range (i.e., outside specified V_{DD} range). This is for information only and devices are guaranteed to operate properly only within the specified range.

Note: The data presented in this section is a statistical summary of data collected on units from different lots over a period of time and matrix samples. 'Typical' represents the mean of the distribution while 'max' or 'min' represents (mean $+3\sigma$) and (mean -3σ) respectively where σ is standard deviation.

FIGURE 16-1: TYPICAL RC OSCILLATOR FREQUENCY vs. TEMPERATURE



TABLE 16-1: RC OSCILLATOR FREQUENCIES

Cext	Rext	Average Fosc @ 5V, 25°C	
		Frequency	Percentage Variation
20 pF	4.7k	4.52 MHz	± 17.35%
	10k	2.47 MHz	± 10.10%
	100k	290.86 kHz	± 11.90%
100 pF	3.3k	1.92 MHz	± 9.43%
	4.7k	1.48 MHz	± 9.83%
	10k	788.77 kHz	± 10.92%
	100k	88.11 kHz	± 16.03%
300 pF	3.3k	726.89 kHz	± 10.97%
	4.7k	573.95 kHz	± 10.14%
	10k	307.31 kHz	± 10.43%
	100k	33.82 kHz	± 11.24%

The percentage variation indicated here is part to part variation due to normal process distribution. The variation indicated is ± 3 standard deviation from average value for $V_{DD} = 5V$.

PIC16C6X

Applicable Devices 61 62 62A R62 63 R63 64 64A R64 65 65A R65 66 67

FIGURE 16-2: TYPICAL RC OSCILLATOR FREQUENCY vs. V_{DD}



FIGURE 16-4: TYPICAL RC OSCILLATOR FREQUENCY vs. V_{DD}

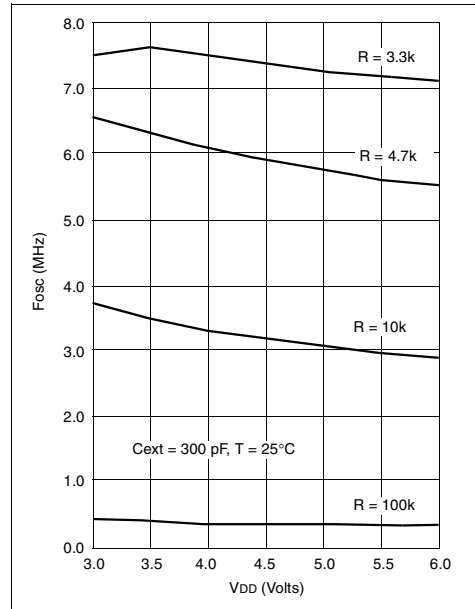
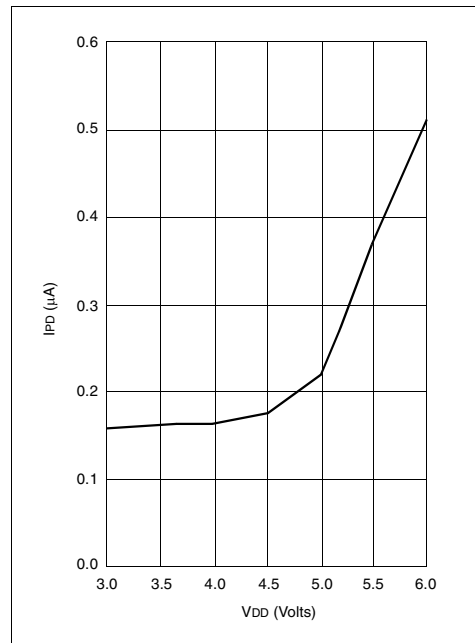

FIGURE 16-3: TYPICAL RC OSCILLATOR FREQUENCY vs. V_{DD}



FIGURE 16-5: TYPICAL IPD vs. V_{DD} WATCHDOG TIMER DISABLED 25°C



Data based on matrix samples. See first page of this section for details.

**FIGURE 16-6: TYPICAL I_{PD} vs. V_{DD}
WATCHDOG TIMER ENABLED
25°C**



**FIGURE 16-7: MAXIMUM I_{PD} vs. V_{DD}
WATCHDOG DISABLED**

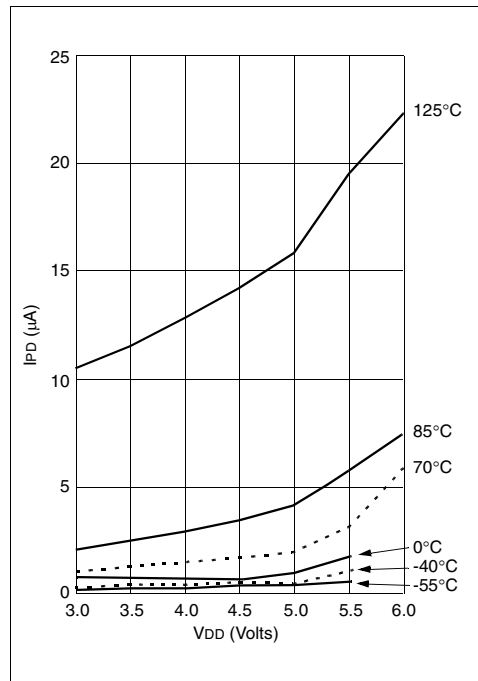

Data based on matrix samples. See first page of this section for details.

PIC16C6X

Applicable Devices 61 62 62A R62 63 R63 64 64A R64 65 65A R65 66 67

**FIGURE 16-8: MAXIMUM IPD vs. VDD
WATCHDOG ENABLED***



**FIGURE 16-9: VTH (INPUT THRESHOLD
VOLTAGE) OF I/O PINS vs.
VDD**



Data based on matrix samples. See first page of this section for details.

*IPD, with Watchdog Timer enabled, has two components: The leakage current which increases with higher temperature and the operating current of the Watchdog Timer logic which increases with lower temperature. At -40°C, the latter dominates explaining the apparently anomalous behavior.

FIGURE 16-10: V_{IH} , V_{IL} OF MCLR, T0CKI AND OSC1 (IN RC MODE) vs. V_{DD}

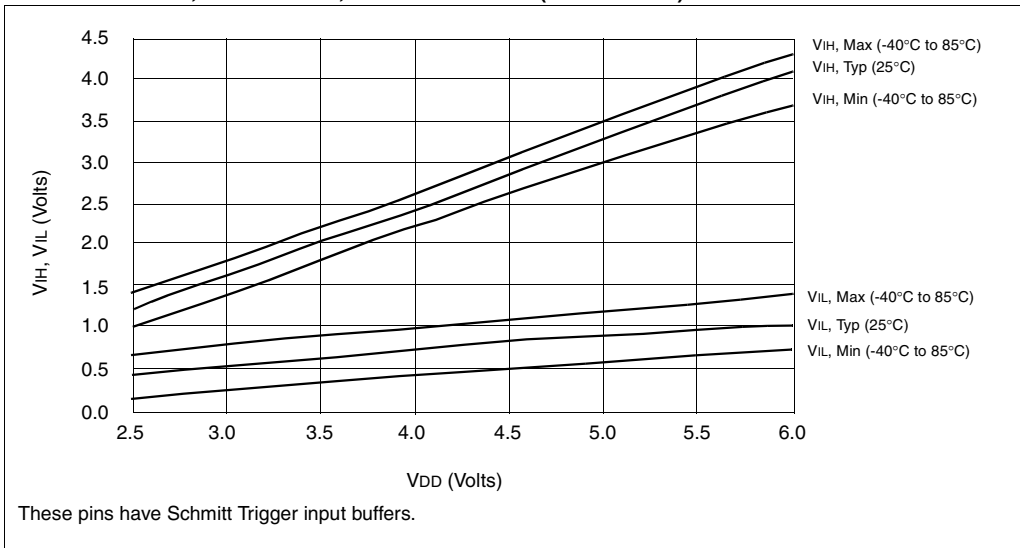
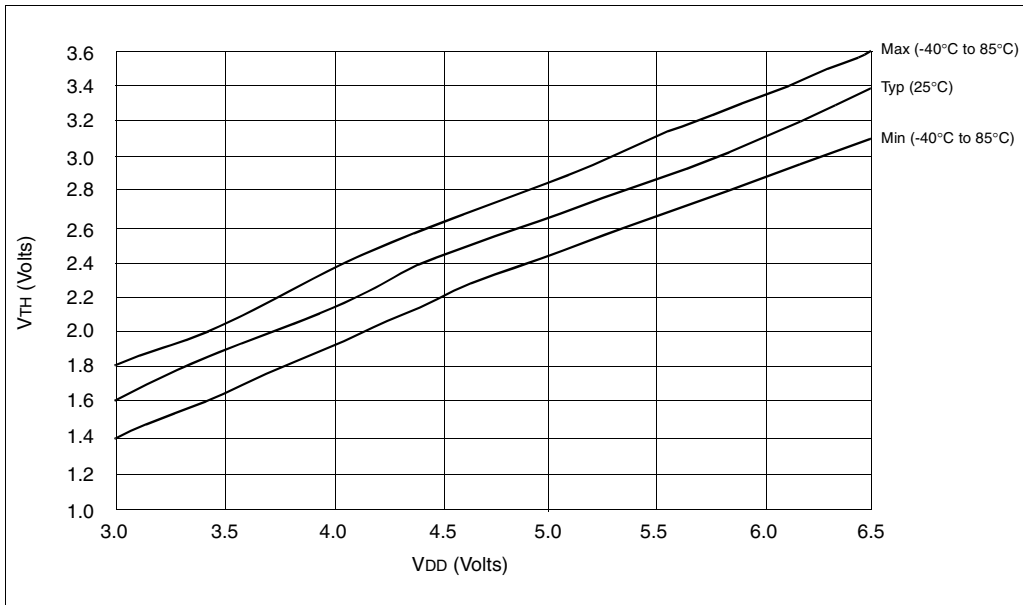

FIGURE 16-11: V_{TH} (INPUT THRESHOLD VOLTAGE) OF OSC1 INPUT (IN XT, HS, AND LP MODES) vs. V_{DD}



Data based on matrix samples. See first page of this section for details.

PIC16C6X

Applicable Devices 61 62 62A R62 63 R63 64 64A R64 65 65A R65 66 67

FIGURE 16-12: TYPICAL I_{DD} vs. FREQUENCY (EXTERNAL CLOCK, 25°C)



FIGURE 16-13: MAXIMUM I_{DD} vs. FREQUENCY (EXTERNAL CLOCK, -40° TO +85°C)



Data based on matrix samples. See first page of this section for details.

FIGURE 16-14: MAXIMUM I_{DD} vs. FREQUENCY (EXTERNAL CLOCK, -55° TO +125°C)



FIGURE 16-15: WDT TIMER TIME-OUT PERIOD vs. V_{DD}



FIGURE 16-16: TRANSCONDUCTANCE (g_m) OF HS OSCILLATOR vs. V_{DD}



Data based on matrix samples. See first page of this section for details.

PIC16C6X

Applicable Devices 61 62 62A R62 63 R63 64 64A R64 65 65A R65 66 67

FIGURE 16-17: TRANSCONDUCTANCE (gm) OF LP OSCILLATOR vs. VDD



FIGURE 16-19: I_{OH} vs. V_{OH}, V_{DD} = 3V



FIGURE 16-18: TRANSCONDUCTANCE (gm) OF XT OSCILLATOR vs. VDD



FIGURE 16-20: I_{OH} vs. V_{OH}, V_{DD} = 5V



Data based on matrix samples. See first page of this section for details.

FIGURE 16-21: IOL vs. VOL, VDD = 3V



FIGURE 16-22: IOL vs. VOL, VDD = 5V



TABLE 16-2: INPUT CAPACITANCE*

Pin Name	Typical Capacitance (pF)	
	18L PDIP	18L SOIC
RA port	5.0	4.3
RB port	5.0	4.3
MCLR	17.0	17.0
OSC1/CLKIN	4.0	3.5
OSC2/CLKOUT	4.3	3.5
T0CKI	3.2	2.8

*All capacitance values are typical at 25°C. A part to part variation of $\pm 25\%$ (three standard deviations) should be taken into account.

Data based on matrix samples. See first page of this section for details.

PIC16C6X

Applicable Devices	61	62	62A	R62	63	R63	64	64A	R64	65	65A	R65	66	67
--------------------	----	----	-----	-----	----	-----	----	-----	-----	----	-----	-----	----	----

NOTES:

17.0 ELECTRICAL CHARACTERISTICS FOR PIC16C62/64

Absolute Maximum Ratings †

Ambient temperature under bias.....	-55°C to +85°C
Storage temperature	-65°C to +150°C
Voltage on any pin with respect to V _{SS} (except V _{DD} , MCLR, and RA4).....	-0.3V to (V _{DD} + 0.3V)
Voltage on V _{DD} with respect to V _{SS}	-0.3V to +7.5V
Voltage on MCLR with respect to V _{SS} (Note 2).....	0V to +14V
Voltage on RA4 with respect to V _{SS}	0V to +14V
Total power dissipation (Note 1).....	1.0W
Maximum current out of V _{SS} pin	300 mA
Maximum current into V _{DD} pin	250 mA
Input clamp current, I _{IK} (V _I < 0 or V _I > V _{DD}).....	±20 mA
Output clamp current, I _{OK} (V _O < 0 or V _O > V _{DD})	±20 mA
Maximum output current sunk by any I/O pin.....	25 mA
Maximum output current sourced by any I/O pin	25 mA
Maximum current sunk by PORTA, PORTB, and PORTE* (combined)	200 mA
Maximum current sourced by PORTA, PORTB, and PORTE* (combined)	200 mA
Maximum current sunk by PORTC and PORTD* (combined).....	200 mA
Maximum current sourced by PORTC and PORTD* (combined)	200 mA

* PORTD and PORTE not available on the PIC16C62.

Note 1: Power dissipation is calculated as follows: P_{dis} = V_{DD} × {I_{DD} - ∑ I_{OH}} + ∑ {(V_{DD}-V_{OH}) × I_{OH}} + ∑ (V_{OL} × I_{OL})

Note 2: Voltage spikes below V_{SS} at the MCLR pin, inducing currents greater than 80 mA, may cause latch-up. Thus, a series resistor of 50-100Ω should be used when applying a “low” level to the MCLR pin rather than pulling this pin directly to V_{SS}.

† NOTICE: Stresses above those listed under “Absolute Maximum Ratings” may cause permanent damage to the device. This is a stress rating only and functional operation of the device at those or any other conditions above those indicated in the operation listings of this specification is not implied. Exposure to maximum rating conditions for extended periods may affect device reliability.

TABLE 17-1: CROSS REFERENCE OF DEVICE SPECS FOR OSCILLATOR CONFIGURATIONS AND FREQUENCIES OF OPERATION (COMMERCIAL DEVICES)

OSC	PIC16C62-04 PIC16C64-04	PIC16C62-10 PIC16C64-10	PIC16C62-20 PIC16C64-20	PIC16LC62-04 PIC16LC64-04	JW Devices
RC	V _{DD} : 4.0V to 6.0V I _{DD} : 3.8 mA max. at 5.5V I _{PD} : 21 μA max. at 4V Freq:4 MHz max.	V _{DD} : 4.5V to 5.5V I _{DD} : 2.0 mA typ. at 5.5V I _{PD} : 1.5 μA typ. at 4V Freq:4 MHz max.	V _{DD} : 4.5V to 5.5V I _{DD} : 2.0 mA typ. at 5.5V I _{PD} : 1.5 μA typ. at 4V Freq:4 MHz max.	V _{DD} : 3.0V to 6.0V I _{DD} : 3.8 mA max. at 3.0V I _{PD} : 13.5 μA max. at 3V Freq: 4 MHz max.	V _{DD} : 4.0V to 6.0V I _{DD} : 3.8 mA max. at 5.5V I _{PD} : 21 μA max. at 4V Freq:4 MHz max.
XT	V _{DD} : 4.0V to 6.0V I _{DD} : 3.8 mA max. at 5.5V I _{PD} : 21 μA max. at 4V Freq:4 MHz max.	V _{DD} : 4.5V to 5.5V I _{DD} : 2.0 mA typ. at 5.5V I _{PD} : 1.5 μA typ. at 4V Freq:4 MHz max.	V _{DD} : 4.5V to 5.5V I _{DD} : 2.0 mA typ. at 5.5V I _{PD} : 1.5 μA typ. at 4V Freq:4 MHz max.	V _{DD} : 3.0V to 6.0V I _{DD} : 3.8 mA max. at 3.0V I _{PD} : 13.5 μA max. at 3.0V Freq: 4 MHz max.	V _{DD} : 4.0V to 6.0V I _{DD} : 3.8 mA max. at 5.5V I _{PD} : 21 μA max. at 4V Freq:4 MHz max.
HS	V _{DD} : 4.5V to 5.5V I _{DD} : 13.5 mA typ. at 5.5V I _{PD} : 1.5 μA typ. at 4.5V Freq:4 MHz max.	V _{DD} : 4.5V to 5.5V I _{DD} : 15 mA max. at 5.5V I _{PD} : 1.5 μA typ. at 4.5V Freq: 10 MHz max.	V _{DD} : 4.5V to 5.5V I _{DD} : 30 mA max. at 5.5V I _{PD} : 1.5 μA typ. at 4.5V Freq: 20 MHz max.	Not recommended for use in HS mode	V _{DD} : 4.5V to 5.5V I _{DD} : 30 mA max. at 5.5V I _{PD} : 1.5 μA typ. at 4.5V Freq: 20 MHz max.
LP	V _{DD} : 4.0V to 6.0V I _{DD} : 52.5 μA typ. at 32 kHz, 4.0V I _{PD} : 0.9 μA typ. at 4.0V Freq:200 kHz max.	Not recommended for use in LP mode	Not recommended for use in LP mode	V _{DD} : 3.0V to 6.0V I _{DD} : 48 μA max. at 32 kHz, 3.0V I _{PD} : 13.5 μA max. at 3.0V Freq:200 kHz max.	V _{DD} : 3.0V to 6.0V I _{DD} : 48 μA max. at 32 kHz, 3.0V I _{PD} :13.5 μA max. at 3.0V Freq:200 kHz max.

The shaded sections indicate oscillator selections which are tested for functionality, but not for MIN/MAX specifications. It is recommended that the user select the device type that ensures the specifications required.

PIC16C6X

Applicable Devices 61 62 62A R62 63 R63 64 64A R64 65 65A R65 66 67

17.1 DC Characteristics: PIC16C62/64-04 (Commercial, Industrial) PIC16C62/64-10 (Commercial, Industrial) PIC16C62/64-20 (Commercial, Industrial)

Standard Operating Conditions (unless otherwise stated)							
DC CHARACTERISTICS							
Operating temperature -40°C ≤ TA ≤ +85°C for industrial and 0°C ≤ TA ≤ +70°C for commercial							
Param No.	Characteristic	Sym	Min	Typ†	Max	Units	Conditions
D001 D001A	Supply Voltage	VDD	4.0 4.5	-	6.0 5.5	V V	XT, RC and LP osc configuration HS osc configuration
D002*	RAM Data Retention Voltage (Note 1)	VDR	-	1.5	-	V	
D003	VDD start voltage to ensure internal Power-on Reset signal	VPOR	-	VSS	-	V	See section on Power-on Reset for details
D004*	VDD rise rate to ensure internal Power-on Reset signal	SVDD	0.05	-	-	V/ms	See section on Power-on Reset for details
D010 D013	Supply Current (Note 2, 5)	IDD	-	2.7 13.5	5.0 30	mA mA	XT, RC, osc configuration FOSC = 4 MHz, VDD = 5.5V (Note 4) HS osc configuration FOSC = 20 MHz, VDD = 5.5V
D020 D021 D021A	Power-down Current (Note 3, 5)	IPD	-	10.5 1.5 1.5	42 21 24	μA μA μA	VDD = 4.0V, WDT enabled, -40°C to +85°C VDD = 4.0V, WDT disabled, -0°C to +70°C VDD = 4.0V, WDT disabled, -40°C to +85°C

* These parameters are characterized but not tested.

† Data in "Typ" column is at 5V, 25°C unless otherwise stated. These parameters are for design guidance only and are not tested.

Note 1: This is the limit to which VDD can be lowered without losing RAM data.

2: The supply current is mainly a function of the operating voltage and frequency. Other factors such as I/O pin loading and switching rate, oscillator type, internal code execution pattern, and temperature also have an impact on the current consumption.

The test conditions for all IDD measurements in active operation mode are:

OSC1 = external square wave, from rail to rail; all I/O pins tristated, pulled to VDD

MCLR = VDD; WDT enabled/disabled as specified.

- The power-down current in SLEEP mode does not depend on the oscillator type. Power-down current is measured with the part in SLEEP mode, with all I/O pins in hi-impedance state and tied to VDD and VSS.
- For RC osc configuration, current through Rext is not included. The current through the resistor can be estimated by the formula $I_r = V_{DD}/2R_{ext}$ (mA) with Rext in kOhm.
- Timer1 oscillator (when enabled) adds approximately 20 μA to the specification. This value is from characterization and is for design guidance only. This is not tested.

17.2 DC Characteristics: PIC16LC62/64-04 (Commercial, Industrial)

DC CHARACTERISTICS		Standard Operating Conditions (unless otherwise stated)					Units	Conditions
Param No.	Characteristic	Sym	Min	Typ†	Max	Operating temperature		
D001	Supply Voltage	VDD	3.0	-	6.0	V	LP, XT, RC osc configuration (DC - 4 MHz)	
D002*	RAM Data Retention Voltage (Note 1)	VDR	-	1.5	-	V		
D003	VDD start voltage to ensure internal Power-on Reset signal	VPOR	-	VSS	-	V	See section on Power-on Reset for details	
D004*	VDD rise rate to ensure internal Power-on Reset signal	SVDD	0.05	-	-	V/ms	See section on Power-on Reset for details	
D010	Supply Current (Note 2, 5)	IDD	-	2.0	3.8	mA	XT, RC osc configuration FOSC = 4 MHz, VDD = 3.0V (Note 4)	
D010A			-	22.5	48	μA	LP osc configuration FOSC = 32 kHz, VDD = 3.0V, WDT disabled	
D020	Power-down Current (Note 3, 5)	IPD	-	7.5	30	μA	VDD = 3.0V, WDT enabled, -40°C to +85°C	
D021			-	0.9	13.5	μA	VDD = 3.0V, WDT disabled, 0°C to +70°C	
D021A			-	0.9	18	μA	VDD = 3.0V, WDT disabled, -40°C to +85°C	

* These parameters are characterized but not tested.

† Data in "Typ" column is at 5V, 25°C unless otherwise stated. These parameters are for design guidance only and are not tested.

Note 1: This is the limit to which VDD can be lowered without losing RAM data.

2: The supply current is mainly a function of the operating voltage and frequency. Other factors such as I/O pin loading and switching rate, oscillator type, internal code execution pattern, and temperature also have an impact on the current consumption.

The test conditions for all IDD measurements in active operation mode are:

OSC1 = external square wave, from rail to rail; all I/O pins tristated, pulled to VDD

MCLR = VDD; WDT enabled/disabled as specified.

3: The power-down current in SLEEP mode does not depend on the oscillator type. Power-down current is measured with the part in SLEEP mode, with all I/O pins in hi-impedance state and tied to VDD and VSS.

4: For RC osc configuration, current through Rext is not included. The current through the resistor can be estimated by the formula $I_r = V_{DD}/2R_{ext}$ (mA) with Rext in kOhm.

5: Timer1 oscillator (when enabled) adds approximately 20 μA to the specification. This value is from characterization and is for design guidance only. This is not tested.

PIC16C6X

Applicable Devices 61 62 62A R62 63 R63 64 64A R64 65 65A R65 66 67

**17.3 DC Characteristics: PIC16C62/64-04 (Commercial, Industrial)
PIC16C62/64-10 (Commercial, Industrial)
PIC16C62/64-20 (Commercial, Industrial)
PIC16LC62/64-04 (Commercial, Industrial)**

Standard Operating Conditions (unless otherwise stated) Operating temperature $-40^{\circ}\text{C} \leq T_A \leq +85^{\circ}\text{C}$ for industrial and $0^{\circ}\text{C} \leq T_A \leq +70^{\circ}\text{C}$ for commercial Operating voltage V_{DD} range as described in DC spec Section 17.1 and Section 17.2							
DC CHARACTERISTICS							
Param No.	Characteristic	Sym	Min	Typ †	Max	Units	Conditions
D030 D030A D031 D032 D033	Input Low Voltage I/O ports with TTL buffer with Schmitt Trigger buffer MCLR, OSC1 (in RC mode) OSC1 (in XT, HS and LP)	V _{IL}	V _{SS}	-	0.15V _{DD} 0.8V 0.2V _{DD} 0.2V _{DD} 0.3V _{DD}	V	For entire V _{DD} range 4.5V ≤ V _{DD} ≤ 5.5V Note1
D040 D040A D041 D042 D042A D043 D070	Input High Voltage I/O ports with TTL buffer with Schmitt Trigger buffer MCLR OSC1 (XT, HS and LP) OSC1 (in RC mode) PORTB weak pull-up current	V _{IH}	2.0 0.25V _{DD} + 0.8V 0.8V _{DD} 0.8V _{DD} 0.7V _{DD} 0.9V _{DD}	-	V _{DD} V _{DD} V _{DD} V _{DD} V _{DD} V _{DD} V _{DD}	V	4.5V ≤ V _{DD} ≤ 5.5V For entire V _{DD} range For entire V _{DD} range Note1
D060 D061 D063	Input Leakage Current (Notes 2, 3) I/O ports MCLR, RA4/T0CKI OSC1	I _{IL}	-	-	±1 ±5 ±5	μA	V _{SS} ≤ V _{PIN} ≤ V _{DD} , Pin at hi-impedance V _{SS} ≤ V _{PIN} ≤ V _{DD} V _{SS} ≤ V _{PIN} ≤ V _{DD} , XT, HS and LP osc configuration
D080 D083	Output Low Voltage I/O ports OSC2/CLKOUT (RC osc config)	V _{OL}	-	-	0.6 0.6	V	I _{OL} = 8.5 mA, V _{DD} = 4.5V, -40°C to +85°C I _{OL} = 1.6 mA, V _{DD} = 4.5V, -40°C to +85°C
D090 D092	Output High Voltage I/O ports (Note 3) OSC2/CLKOUT (RC osc config)	V _{OH}	V _{DD} -0.7 V _{DD} -0.7	-	-	V	I _{OH} = -3.0 mA, V _{DD} = 4.5V, -40°C to +85°C I _{OH} = -1.3 mA, V _{DD} = 4.5V, -40°C to +85°C
D150*	Open-Drain High Voltage	V _{OD}	-	-	14	V	RA4 pin

* These parameters are characterized but not tested.

† Data in "Typ" column is at 5V, 25°C unless otherwise stated. These parameters are for design guidance only and are not tested.

Note 1: In RC oscillator configuration, the OSC1/CLKIN pin is a Schmitt Trigger input. It is not recommended that the PIC16C6X be driven with external clock in RC mode.

2: The leakage current on the MCLR/VPP pin is strongly dependent on the applied voltage level. The specified levels represent normal operating conditions. Higher leakage current may be measured at different input voltages.

3: Negative current is defined as current sourced by the pin.

PIC16C6X

Applicable Devices 61 62 62A R62 63 R63 64 64A R64 65 65A R65 66 67

DC CHARACTERISTICS		Standard Operating Conditions (unless otherwise stated)					
		Operating temperature -40°C ≤ TA ≤ +85°C for industrial and 0°C ≤ TA ≤ +70°C for commercial Operating voltage VDD range as described in DC spec Section 17.1 and Section 17.2					
Param No.	Characteristic	Sym	Min	Typ †	Max	Units	Conditions
D100	Capacitive Loading Specs on Output Pins						In XT, HS and LP modes when external clock is used to drive OSC1.
	OSC2 pin	COsc2	-	-	15	pF	
D101	All I/O pins and OSC2 (in RC mode)	CIo	-	-	50	pF	
D102	SCL, SDA in I ² C mode	Cb	-	-	400	pF	

* These parameters are characterized but not tested.

† Data in "Typ" column is at 5V, 25°C unless otherwise stated. These parameters are for design guidance only and are not tested.

- Note 1: In RC oscillator configuration, the OSC1/CLKIN pin is a Schmitt Trigger input. It is not recommended that the PIC16C6X be driven with external clock in RC mode.
- 2: The leakage current on the MCLR/VPP pin is strongly dependent on the applied voltage level. The specified levels represent normal operating conditions. Higher leakage current may be measured at different input voltages.
- 3: Negative current is defined as current sourced by the pin.

PIC16C6X

Applicable Devices 61 62 62A R62 63 R63 64 64A R64 65 65A R65 66 67

17.4 Timing Parameter Symbology

The timing parameter symbols have been created following one of the following formats:

1. TppS2ppS
2. TppS
3. TCC:ST (I²C specifications only)
4. Ts (I²C specifications only)

T		T	Time
F	Frequency		

Lowercase letters (pp) and their meanings:

pp		osc	OSC1
cc	CCP1	rd	\overline{RD}
ck	CLKOUT	rw	\overline{RD} or \overline{WR}
cs	\overline{CS}	sc	SCK
di	SDI	ss	\overline{SS}
do	SDO	t0	T0CKI
dt	Data in	t1	T1CKI
io	I/O port	wr	\overline{WR}
mc	\overline{MCLR}		

Uppercase letters and their meanings:

S		P	Period
F	Fall	R	Rise
H	High	V	Valid
I	Invalid (Hi-impedance)	Z	Hi-impedance
L	Low		
I²C only		High	High
AA	output access	Low	Low
BUF	Bus free		

TCC:ST (I²C specifications only)

CC		SU	Setup
HD	Hold		
ST		STO	STOP condition
DAT	DATA input hold		
STA	START condition		

FIGURE 17-1: LOAD CONDITIONS FOR DEVICE TIMING SPECIFICATIONS



17.5 Timing Diagrams and Specifications

FIGURE 17-2: EXTERNAL CLOCK TIMING



TABLE 17-2: EXTERNAL CLOCK TIMING REQUIREMENTS

Parameter No.	Sym	Characteristic	Min	Typ†	Max	Units	Conditions
	Fosc	External CLKIN Frequency (Note 1)	DC	—	4	MHz	XT and RC osc mode
			DC	—	4	MHz	HS osc mode (-04)
			DC	—	10	MHz	HS osc mode (-10)
			DC	—	20	MHz	HS osc mode (-20)
			DC	—	200	kHz	LP osc mode
		Oscillator Frequency (Note 1)	DC	—	4	MHz	RC osc mode
			0.1	—	4	MHz	XT osc mode
			4	—	20	MHz	HS osc mode
			5	—	200	kHz	LP osc mode
1	Tosc	External CLKIN Period (Note 1)	250	—	—	ns	XT and RC osc mode
			250	—	—	ns	HS osc mode (-04)
			100	—	—	ns	HS osc mode (-10)
			50	—	—	ns	HS osc mode (-20)
			5	—	—	μs	LP osc mode
		Oscillator Period (Note 1)	250	—	—	ns	RC osc mode
			250	—	10,000	ns	XT osc mode
			250	—	250	ns	HS osc mode (-04)
			100	—	250	ns	HS osc mode (-10)
			50	—	1,000	ns	HS osc mode (-20)
			5	—	—	μs	LP osc mode
2	TCY	Instruction Cycle Time (Note 1)	200	TCY	DC	ns	TCY = 4/Fosc
3	TosL, TosH	External Clock in (OSC1) High or Low Time	100	—	—	ns	XT oscillator
			2.5	—	—	μs	LP oscillator
			15	—	—	ns	HS oscillator
4	TosR, TosF	External Clock in (OSC1) Rise or Fall Time	—	—	25	ns	XT oscillator
			—	—	50	ns	LP oscillator
			—	—	15	ns	HS oscillator

† Data in "Typ" column is at 5V, 25°C unless otherwise stated. These parameters are for design guidance only and are not tested.

Note 1: Instruction cycle period (TCY) equals four times the input oscillator time-base period. All specified values are based on characterization data for that particular oscillator type under standard operating conditions with the device executing code. Exceeding these specified limits may result in an unstable oscillator operation and/or higher than expected current consumption. All devices are tested to operate at "min." values with an external clock applied to the OSC1/CLKIN pin. When an external clock input is used, the "Max." cycle time limit is "DC" (no clock) for all devices.

PIC16C6X

Applicable Devices 61 62 62A R62 63 R63 64 64A R64 65 65A R65 66 67

FIGURE 17-3: CLKOUT AND I/O TIMING

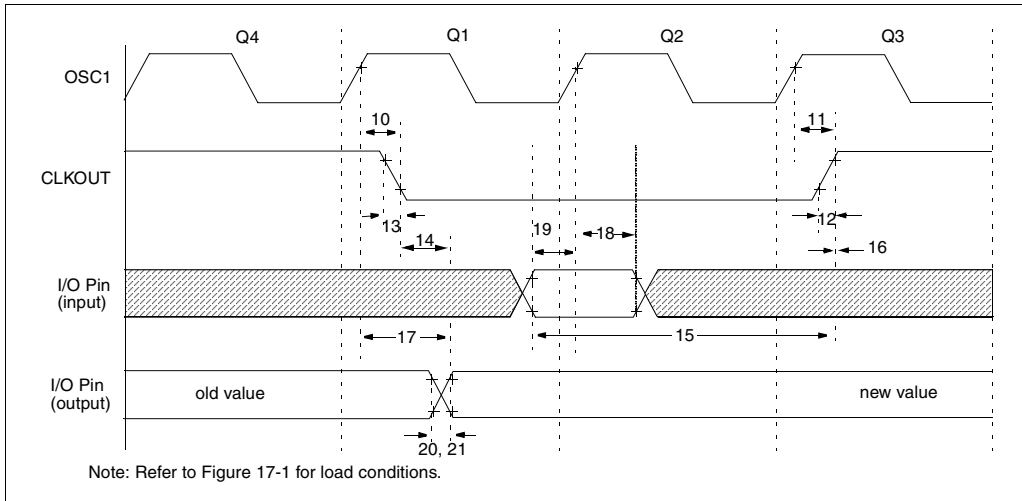

TABLE 17-3: CLKOUT AND I/O TIMING REQUIREMENTS

Parameters	Sym	Characteristic	Min	Typ†	Max	Units	Conditions	
10*	TosH2ckL	OSC1↑ to CLKOUT↓	—	75	200	ns	Note 1	
11*	TosH2ckH	OSC1↑ to CLKOUT↑	—	75	200	ns	Note 1	
12*	TckR	CLKOUT rise time	—	35	100	ns	Note 1	
13*	TckF	CLKOUT fall time	—	35	100	ns	Note 1	
14*	TckL2ioV	CLKOUT ↓ to Port out valid	—	—	0.5TCY + 20	ns	Note 1	
15*	TioV2ckH	Port in valid before CLKOUT ↑	Tosc + 200	—	—	ns	Note 1	
16*	TckH2ioI	Port in hold after CLKOUT ↑	0	—	—	ns	Note 1	
17*	TosH2ioV	OSC1↑ (Q1 cycle) to Port out valid	—	50	150	ns		
18*	TosH2ioI	OSC1↑ (Q2 cycle) to Port input invalid (I/O in hold time)	PIC16C62/64	100	—	—	ns	
		PIC16LC62/64	200	—	—	ns		
19*	TioV2osH	Port input valid to OSC1↑ (I/O in setup time)	0	—	—	ns		
20*	TioR	Port output rise time	PIC16C62/64	—	10	40	ns	
			PIC16LC62/64	—	—	80	ns	
21*	TioF	Port output fall time	PIC16C62/64	—	10	40	ns	
			PIC16LC62/64	—	—	80	ns	
22††*	Tinp	INT pin high or low time	TCY	—	—	ns		
23††*	Trbp	RB7:RB4 change INT high or low time	TCY	—	—	ns		

* These parameters are characterized but not tested.

† Data in "Typ" column is at 5V, 25°C unless otherwise stated. These parameters are for design guidance only and are not tested.

†† These parameters are asynchronous events not related to any internal clock edge.

Note 1: Measurements are taken in RC Mode where CLKOUT output is 4 x Tosc.

FIGURE 17-4: RESET, WATCHDOG TIMER, OSCILLATOR START-UP TIMER AND POWER-UP TIMER TIMING



TABLE 17-4: RESET, WATCHDOG TIMER, OSCILLATOR START-UP TIMER AND POWER-UP TIMER REQUIREMENTS

Parameter No.	Sym	Characteristic	Min	Typ†	Max	Units	Conditions
30*	Tmcl	MCLR Pulse Width (low)	100	—	—	ns	VDD = 5V, -40°C to +85°C
31*	Twdt	Watchdog Timer Time-out Period (No Prescaler)	7	18	33	ms	VDD = 5V, -40°C to +85°C
32	Tost	Oscillation Start-up Timer Period	—	1024Tosc	—	—	Tosc = OSC1 period
33*	Tpwrt	Power-up Timer Period	28	72	132	ms	VDD = 5V, -40°C to +85°C
34*	Tioz	I/O Hi-impedance from MCLR Low	—	—	100	ns	

* These parameters are characterized but not tested.

† Data in "Typ" column is at 5V, 25°C unless otherwise stated. These parameters are for design guidance only and are not tested.

PIC16C6X

Applicable Devices | 61 | 62 | 62A | R62 | 63 | R63 | 64 | 64A | R64 | 65 | 65A | R65 | 66 | 67

FIGURE 17-5: TIMER0 AND TIMER1 EXTERNAL CLOCK TIMINGS

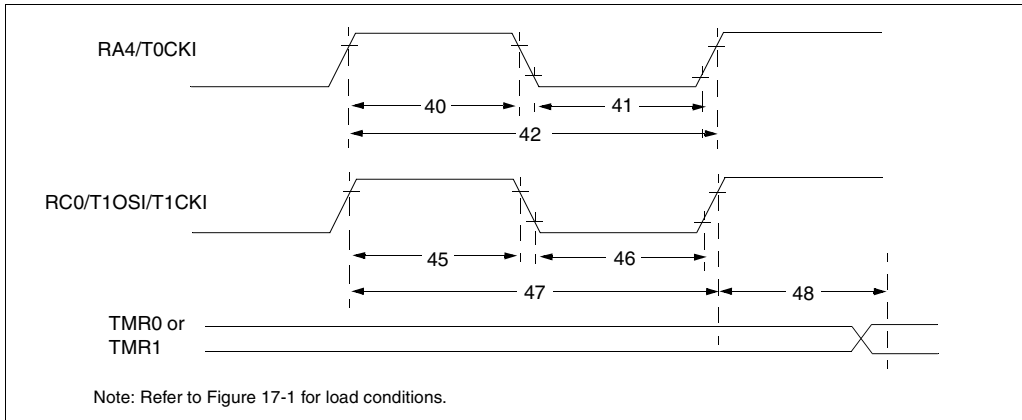

TABLE 17-5: TIMER0 AND TIMER1 EXTERNAL CLOCK REQUIREMENTS

Param No.	Sym	Characteristic		Min	Typ†	Max	Units	Conditions
40*	Tt0H	T0CKI High Pulse Width	No Prescaler	$0.5T_{CY} + 20$	—	—	ns	Must also meet parameter 42
			With Prescaler	10	—	—	ns	
41*	Tt0L	T0CKI Low Pulse Width	No Prescaler	$0.5T_{CY} + 20$	—	—	ns	Must also meet parameter 42
			With Prescaler	10	—	—	ns	
42*	Tt0P	T0CKI Period	No Prescaler	$T_{CY} + 40$	—	—	ns	N = prescale value (2, 4, ..., 256)
			With Prescaler	Greater of: 20 or $\frac{T_{CY} + 40}{N}$	—	—	ns	
45*	Tt1H	T1CKI High Time	Synchronous, Prescaler = 1	$0.5T_{CY} + 20$	—	—	ns	Must also meet parameter 47
			Synchronous, Prescaler = 2,4,8	PIC16C6X: 15 PIC16LC6X: 25	—	—	ns	
			Asynchronous	PIC16C6X: 30 PIC16LC6X: 50	—	—	ns	
					—	—	ns	
46*	Tt1L	T1CKI Low Time	Synchronous, Prescaler = 1	$0.5T_{CY} + 20$	—	—	ns	Must also meet parameter 47
			Synchronous, Prescaler = 2,4,8	PIC16C6X: 15 PIC16LC6X: 25	—	—	ns	
			Asynchronous	PIC16C6X: 30 PIC16LC6X: 50	—	—	ns	
					—	—	ns	
47*	Tt1P	T1CKI input period	Synchronous	Greater of: 30 or $\frac{T_{CY} + 40}{N}$	—	—	ns	N = prescale value (1, 2, 4, 8)
				Greater of: 50 or $\frac{T_{CY} + 40}{N}$				N = prescale value (1, 2, 4, 8)
			Asynchronous	PIC16C6X: 60 PIC16LC6X: 100	—	—	ns	
	Ft1	Timer1 oscillator input frequency range (oscillator enabled by setting bit T1OSCEN)		DC	—	200	kHz	
48	TCKEZtmr1	Delay from external clock edge to timer increment		$2T_{osc}$	—	$7T_{osc}$	—	

* These parameters are characterized but not tested.

† Data in "Typ" column is at 5V, 25°C unless otherwise stated. These parameters are for design guidance only and are not tested.

FIGURE 17-6: CAPTURE/COMPARE/PWM TIMINGS (CCP1)



TABLE 17-6: CAPTURE/COMPARE/PWM REQUIREMENTS (CCP1)

Parameter No.	Sym	Characteristic		Min	Typ†	Max	Units	Conditions	
50*	TccL	CCP1 input low time	No Prescaler	$0.5T_{CY} + 20$	—	—	ns		
			With Prescaler	PIC16C62/64	10	—	—		ns
				PIC16LC62/64	20	—	—		ns
51*	TccH	CCP1 input high time	No Prescaler	$0.5T_{CY} + 20$	—	—	ns		
			With Prescaler	PIC16C62/64	10	—	—		ns
				PIC16LC62/64	20	—	—		ns
52*	TccP	CCP1 input period		$\frac{3T_{CY} + 40}{N}$	—	—	ns	N = prescale value (1,4 or 16)	
53	TccR	CCP1 output rise time	PIC16C62/64	—	10	25	ns		
			PIC16LC62/64	—	25	45	ns		
54	TccF	CCP1 output fall time	PIC16C62/64	—	10	25	ns		
			PIC16LC62/64	—	25	45	ns		

* These parameters are characterized but not tested.

† Data in "Typ" column is at 5V, 25°C unless otherwise stated. These parameters are for design guidance only and are not tested.

PIC16C6X

Applicable Devices 61 62 62A R62 63 R63 64 64A R64 65 65A R65 66 67

FIGURE 17-7: PARALLEL SLAVE PORT TIMING (PIC16C64)



TABLE 17-7: PARALLEL SLAVE PORT REQUIREMENTS (PIC16C64)

Parameter No.	Sym	Characteristic	Min	Typ†	Max	Units	Conditions	
62	TdtV2wrH	Data in valid before $\overline{WR}\uparrow$ or $\overline{CS}\uparrow$ (setup time)	20	—	—	ns		
63*	TwrH2dtI	$\overline{WR}\uparrow$ or $\overline{CS}\uparrow$ to data-in invalid (hold time)	PIC16C64	20	—	—	ns	
			PIC16LC64	35	—	—	ns	
64	TrdL2dtV	$\overline{RD}\downarrow$ and $\overline{CS}\downarrow$ to data-out valid	—	—	80	ns		
65	TrdH2dtI	$\overline{RD}\uparrow$ or $\overline{CS}\uparrow$ to data-out invalid	10	—	30	ns		

* These parameters are characterized but not tested.

† Data in "Typ" column is at 5V, 25°C unless otherwise stated. These parameters are for design guidance only and are not tested.

FIGURE 17-8: SPI MODE TIMING



TABLE 17-8: SPI MODE REQUIREMENTS

Parameter No.	Sym	Characteristic	Min	Typ†	Max	Units	Conditions
70	TssL2scH, TssL2scL	$\overline{SS}\downarrow$ to SCK \downarrow or SCK \uparrow input	T _{CY}	—	—	ns	
71	TscH	SCK input high time (slave mode)	T _{CY} + 20	—	—	ns	
72	TscL	SCK input low time (slave mode)	T _{CY} + 20	—	—	ns	
73	TdiV2scH, TdiV2scL	Setup time of SDI data input to SCK edge	50	—	—	ns	
74	Tsch2diL, TscL2diL	Hold time of SDI data input to SCK edge	50	—	—	ns	
75	TdoR	SDO data output rise time	—	10	25	ns	
76	TdoF	SDO data output fall time	—	10	25	ns	
77	TssH2doZ	$\overline{SS}\uparrow$ to SDO output hi-impedance	10	—	50	ns	
78	TscR	SCK output rise time (master mode)	—	10	25	ns	
79	TscF	SCK output fall time (master mode)	—	10	25	ns	
80	Tsch2doV, TscL2doV	SDO data output valid after SCK edge	—	—	50	ns	

† Data in "Typ" column is at 5V, 25°C unless otherwise stated. These parameters are for design guidance only and are not tested.

PIC16C6X

Applicable Devices 61 62 62A R62 63 R63 64 64A R64 65 65A R65 66 67

FIGURE 17-9: I²C BUS START/STOP BITS TIMING



TABLE 17-9: I²C BUS START/STOP BITS REQUIREMENTS

Parameter No.	Sym	Characteristic	Min	Typ	Max	Units	Conditions	
90	TSU:STA	START condition	100 kHz mode	4700	—	—	ns	Only relevant for repeated START condition
		Setup time	400 kHz mode	600	—	—		
91	THD:STA	START condition	100 kHz mode	4000	—	—	ns	After this period the first clock pulse is generated
		Hold time	400 kHz mode	600	—	—		
92	TSU:STO	STOP condition	100 kHz mode	4700	—	—	ns	
		Setup time	400 kHz mode	600	—	—		
93	THD:STO	STOP condition	100 kHz mode	4000	—	—	ns	
		Hold time	400 kHz mode	600	—	—		

FIGURE 17-10: I²C BUS DATA TIMING



TABLE 17-10: I²C BUS DATA REQUIREMENTS

Parameter No.	Sym	Characteristic	Min	Max	Units	Conditions	
100	THIGH	Clock high time	100 kHz mode	4.0	—	μs	Device must operate at a minimum of 1.5 MHz
			400 kHz mode	0.6	—	μs	
			SSP Module	1.5T _{CY}	—		
101	TLOW	Clock low time	100 kHz mode	4.7	—	μs	Device must operate at a minimum of 1.5 MHz
			400 kHz mode	1.3	—	μs	
			SSP Module	1.5T _{CY}	—		
102	TR	SDA and SCL rise time	100 kHz mode	—	1000	ns	Cb is specified to be from 10 to 400 pF
			400 kHz mode	20 + 0.1Cb	300	ns	
103	TF	SDA and SCL fall time	100 kHz mode	—	300	ns	Cb is specified to be from 10 to 400 pF
			400 kHz mode	20 + 0.1Cb	300	ns	
90	TSU:STA	START condition setup time	100 kHz mode	4.7	—	μs	Only relevant for repeated START condition
			400 kHz mode	0.6	—	μs	
91	THD:STA	START condition hold time	100 kHz mode	4.0	—	μs	After this period the first clock pulse is generated
			400 kHz mode	0.6	—	μs	
106	THD:DAT	Data input hold time	100 kHz mode	0	—	ns	
			400 kHz mode	0	0.9	μs	
107	TSU:DAT	Data input setup time	100 kHz mode	250	—	ns	Note 2
			400 kHz mode	100	—	ns	
92	TSU:STO	STOP condition setup time	100 kHz mode	4.7	—	μs	
			400 kHz mode	0.6	—	μs	
109	TAA	Output valid from clock	100 kHz mode	—	3500	ns	Note 1
			400 kHz mode	—	—	ns	
110	TBUF	Bus free time	100 kHz mode	4.7	—	μs	Time the bus must be free before a new transmission can start
			400 kHz mode	1.3	—	μs	
	Cb	Bus capacitive loading	—	400	pF		

Note 1: As a transmitter, the device must provide this internal minimum delay time to bridge the undefined region (min. 300 ns) of the falling edge of SCL to avoid unintended generation of START or STOP conditions.

2: A fast-mode (400 kHz) I²C-bus device can be used in a standard-mode (100 kHz) I²C-bus system, but the requirement tsu:DAT ≥ 250 ns must then be met. This will automatically be the case if the device does not stretch the LOW period of the SCL signal. If such a device does stretch the LOW period of the SCL signal, it must output the next data bit to the SDA line TR max. + tsu:DAT = 1000 + 250 = 1250 ns (according to the standard-mode I²C bus specification) before the SCL line is released.

PIC16C6X

Applicable Devices	61	62	62A	R62	63	R63	64	64A	R64	65	65A	R65	66	67
--------------------	----	----	-----	-----	----	-----	----	-----	-----	----	-----	-----	----	----

NOTES:

18.0 ELECTRICAL CHARACTERISTICS FOR PIC16C62A/R62/64A/R64

Absolute Maximum Ratings †

Ambient temperature under bias.....	-55°C to +125°C
Storage temperature	-65°C to +150°C
Voltage on any pin with respect to VSS (except VDD, MCLR, and RA4).....	-0.3V to (VDD + 0.3V)
Voltage on VDD with respect to VSS	-0.3V to +7.5V
Voltage on MCLR with respect to VSS (Note 2).....	0V to +14V
Voltage on RA4 with respect to VSS	0V to +14V
Total power dissipation (Note 1).....	1.0W
Maximum current out of VSS pin	300 mA
Maximum current into VDD pin	250 mA
Input clamp current, I _{IK} (V _I < 0 or V _I > VDD).....	±20 mA
Output clamp current, I _{OK} (V _O < 0 or V _O > VDD)	±20 mA
Maximum output current sunk by any I/O pin.....	25 mA
Maximum output current sourced by any I/O pin	25 mA
Maximum current sunk by PORTA, PORTB, and PORTE (combined).....	200 mA
Maximum current sourced by PORTA, PORTB, and PORTE (combined)	200 mA
Maximum current sunk by PORTC and PORTD (combined)	200 mA
Maximum current sourced by PORTC and PORTD (combined).....	200 mA

Note 1: Power dissipation is calculated as follows: $P_{dis} = V_{DD} \times \{I_{DD} - \sum I_{OH}\} + \sum \{(V_{DD} - V_{OH}) \times I_{OH}\} + \sum (V_{OL} \times I_{OL})$

Note 2: Voltage spikes below VSS at the MCLR pin, inducing currents greater than 80 mA, may cause latch-up. Thus, a series resistor of 50-100Ω should be used when applying a “low” level to the MCLR pin rather than pulling this pin directly to VSS.

† NOTICE: Stresses above those listed under “Absolute Maximum Ratings” may cause permanent damage to the device. This is a stress rating only and functional operation of the device at those or any other conditions above those indicated in the operation listings of this specification is not implied. Exposure to maximum rating conditions for extended periods may affect device reliability.

TABLE 18-1: CROSS REFERENCE OF DEVICE SPECS FOR OSCILLATOR CONFIGURATIONS AND FREQUENCIES OF OPERATION (COMMERCIAL DEVICES)

OSC	PIC16C62A-04 PIC16CR62-04 PIC16C64A-04 PIC16CR64-04	PIC16C62A-10 PIC16CR62-10 PIC16C64A-10 PIC16CR64-10	PIC16C62A-20 PIC16CR62-20 PIC16C64A-20 PIC16CR64-20	PIC16LC62A-04 PIC16LCR62-04 PIC16LC64A-04 PIC16LCR64-04	JW Devices
RC	VDD: 4.0V to 6.0V IDD: 5 mA max. at 5.5V IPD: 16 μA max. at 4V Freq: 4 MHz max.	VDD: 4.5V to 5.5V IDD: 2.0 mA typ. at 5.5V IPD: 1.5 μA typ. at 4V Freq: 4 MHz max.	VDD: 4.5V to 5.5V IDD: 2.0 mA typ. at 5.5V IPD: 1.5 μA typ. at 4V Freq: 4 MHz max.	VDD: 2.5V to 6.0V IDD: 3.8 mA max. at 3.0V IPD: 5 μA max. at 3V Freq: 4 MHz max.	VDD: 4.0V to 6.0V IDD: 5 mA max. at 5.5V IPD: 16 μA max. at 4V Freq: 4 MHz max.
XT	VDD: 4.0V to 6.0V IDD: 5 mA max. at 5.5V IPD: 16 μA max. at 4V Freq: 4 MHz max.	VDD: 4.5V to 5.5V IDD: 2.0 mA typ. at 5.5V IPD: 1.5 μA typ. at 4V Freq: 4 MHz max.	VDD: 4.5V to 5.5V IDD: 2.0 mA typ. at 5.5V IPD: 1.5 μA typ. at 4V Freq: 4 MHz max.	VDD: 2.5V to 6.0V IDD: 3.8 mA max. at 3.0V IPD: 5 μA max. at 3.0V Freq: 4 MHz max.	VDD: 4.0V to 6.0V IDD: 5 mA max. at 5.5V IPD: 16 μA max. at 4V Freq: 4 MHz max.
HS	VDD: 4.5V to 5.5V IDD: 13.5 mA typ. at 5.5V IPD: 1.5 μA typ. at 4.5V Freq: 4 MHz max.	VDD: 4.5V to 5.5V IDD: 10 mA max. at 5.5V IPD: 1.5 μA typ. at 4.5V Freq: 10 MHz max.	VDD: 4.5V to 5.5V IDD: 20 mA max. at 5.5V IPD: 1.5 μA typ. at 4.5V Freq: 20 MHz max.	Not recommended for use in HS mode	VDD: 4.5V to 5.5V IDD: 20 mA max. at 5.5V IPD: 1.5 μA typ. at 4.5V Freq: 20 MHz max.
LP	VDD: 4.0V to 6.0V IDD: 52.5 μA typ. at 32 kHz, 4.0V IPD: 0.9 μA typ. at 4.0V Freq: 200 kHz max.	Not recommended for use in LP mode	Not recommended for use in LP mode	VDD: 2.5V to 6.0V IDD: 48 μA max. at 32 kHz, 3.0V IPD: 5 μA max. at 3.0V Freq: 200 kHz max.	VDD: 2.5V to 6.0V IDD: 48 μA max. at 32 kHz, 3.0V IPD: 5 μA max. at 3.0V Freq: 200 kHz max.

The shaded sections indicate oscillator selections which are tested for functionality, but not for MIN/MAX specifications. It is recommended that the user select the device type that ensures the specifications required.

PIC16C6X

Applicable Devices 61 62 62A R62 63 R63 64 64A R64 65 65A R65 66 67

18.1 DC Characteristics: PIC16C62A/R62/64A/R64-04 (Commercial, Industrial, Extended) PIC16C62A/R62/64A/R64-10 (Commercial, Industrial, Extended) PIC16C62A/R62/64A/R64-20 (Commercial, Industrial, Extended)

Standard Operating Conditions (unless otherwise stated)							
DC CHARACTERISTICS							
		Operating temperature -40°C ≤ TA ≤ +125°C for extended, -40°C ≤ TA ≤ +85°C for industrial and 0°C ≤ TA ≤ +70°C for commercial					
Param No.	Characteristic	Sym	Min	Typ†	Max	Units	Conditions
D001 D001A	Supply Voltage	VDD	4.0 4.5	-	6.0 5.5	V V	XT, RC and LP osc configuration HS osc configuration
D002*	RAM Data Retention Voltage (Note 1)	VDR	-	1.5	-	V	
D003	VDD start voltage to ensure internal Power-on Reset signal	VPOR	-	VSS	-	V	See section on Power-on Reset for details
D004*	VDD rise rate to ensure internal Power-on Reset signal	SVDD	0.05	-	-	V/ms	See section on Power-on Reset for details
D005	Brown-out Reset Voltage	BVDD	3.7 3.7	4.0 4.0	4.3 4.4	V V	BODEN bit in configuration word enabled Extended Range Only
D010 D013	Supply Current (Note 2, 5)	IDD	-	2.7 10	5 20	mA mA	XT, RC, osc configuration FOSC = 4 MHz, VDD = 5.5V (Note 4) HS osc configuration FOSC = 20 MHz, VDD = 5.5V
D015*	Brown-out Reset Current (Note 6)	Δ IBOR	-	350	425	μA	BOR enabled, VDD = 5.0V
D020 D021 D021A D021B	Power-down Current (Note 3, 5)	IPD	-	10.5 1.5 1.5 2.5	42 16 19 19	μA μA μA μA	VDD = 4.0V, WDT enabled, -40°C to +85°C VDD = 4.0V, WDT disabled, -0°C to +70°C VDD = 4.0V, WDT disabled, -40°C to +85°C VDD = 4.0V, WDT disabled, -40°C to +125°C
D023*	Brown-out Reset Current (Note 6)	Δ IBOR	-	350	425	μA	BOR enabled, VDD = 5.0V

* These parameters are characterized but not tested.

† Data in "Typ" column is at 5V, 25°C unless otherwise stated. These parameters are for design guidance only and are not tested.

Note 1: This is the limit to which VDD can be lowered without losing RAM data.

2: The supply current is mainly a function of the operating voltage and frequency. Other factors such as I/O pin loading and switching rate, oscillator type, internal code execution pattern, and temperature also have an impact on the current consumption.

The test conditions for all IDD measurements in active operation mode are:

OSC1 = external square wave, from rail to rail; all I/O pins tristated, pulled to VDD

\overline{MCLR} = VDD; WDT enabled/disabled as specified.

3: The power-down current in SLEEP mode does not depend on the oscillator type. Power-down current is measured with the part in SLEEP mode, with all I/O pins in hi-impedance state and tied to VDD and VSS.

4: For RC osc configuration, current through Rext is not included. The current through the resistor can be estimated by the formula $I_r = VDD/2R_{ext}$ (mA) with Rext in kOhm.

5: Timer1 oscillator (when enabled) adds approximately 20 μA to the specification. This value is from characterization and is for design guidance only. This is not tested.

6: The Δ current is the additional current consumed when this peripheral is enabled. This current should be added to the base IDD or IPD measurement.

18.2 DC Characteristics: PIC16LC62A/R62/64A/R64-04 (Commercial, Industrial)

DC CHARACTERISTICS		Standard Operating Conditions (unless otherwise stated)						Conditions
Param No.	Characteristic	Sym	Min	Typ†	Max	Units		
D001	Supply Voltage	VDD	2.5	-	6.0	V	LP, XT, RC osc configuration (DC - 4 MHz)	
D002*	RAM Data Retention Voltage (Note 1)	VDR	-	1.5	-	V		
D003	VDD start voltage to ensure internal Power-on Reset signal	VPOR	-	VSS	-	V	See section on Power-on Reset for details	
D004*	VDD rise rate to ensure internal Power-on Reset signal	SVDD	0.05	-	-	V/ms	See section on Power-on Reset for details	
D005	Brown-out Reset Voltage	BVDD	3.7	4.0	4.3	V	BODEN bit in configuration word enabled	
D010	Supply Current (Note 2, 5)	IDD	-	2.0	3.8	mA	XT, RC osc configuration FOSC = 4 MHz, VDD = 3.0V (Note 4)	
D010A			-	22.5	48	μA	LP osc configuration FOSC = 32 kHz, VDD = 3.0V, WDT disabled	
D015*	Brown-out Reset Current (Note 6)	ΔIBOR	-	350	425	μA	BOR enabled, VDD = 5.0V	
D020	Power-down Current (Note 3, 5)	IPD	-	7.5	30	μA	VDD = 3.0V, WDT enabled, -40°C to +85°C	
D021			-	0.9	5	μA	VDD = 3.0V, WDT disabled, 0°C to +70°C	
D021A			-	0.9	5	μA	VDD = 3.0V, WDT disabled, -40°C to +85°C	
D023*	Brown-out Reset Current (Note 6)	ΔIBOR	-	350	425	μA	BOR enabled, VDD = 5.0V	

* These parameters are characterized but not tested.

† Data in "Typ" column is at 5V, 25°C unless otherwise stated. These parameters are for design guidance only and are not tested.

Note 1: This is the limit to which VDD can be lowered without losing RAM data.

2: The supply current is mainly a function of the operating voltage and frequency. Other factors such as I/O pin loading and switching rate, oscillator type, internal code execution pattern, and temperature also have an impact on the current consumption.

The test conditions for all IDD measurements in active operation mode are:

OSC1 = external square wave, from rail to rail; all I/O pins tristated, pulled to VDD

MCLR = VDD; WDT enabled/disabled as specified.

3: The power-down current in SLEEP mode does not depend on the oscillator type. Power-down current is measured with the part in SLEEP mode, with all I/O pins in hi-impedance state and tied to VDD and VSS.

4: For RC osc configuration, current through Rext is not included. The current through the resistor can be estimated by the formula $I_r = V_{DD}/2R_{ext}$ (mA) with Rext in kΩ.

5: Timer1 oscillator (when enabled) adds approximately 20 μA to the specification. This value is from characterization and is for design guidance only. This is not tested.

6: The Δ current is the additional current consumed when this peripheral is enabled. This current should be added to the base IDD or IPD measurement.

PIC16C6X

Applicable Devices 61 62 62A R62 63 R63 64 64A R64 65 65A R65 66 67

18.3 DC Characteristics: PIC16C62A/R62/64A/R64-04 (Commercial, Industrial, Extended)
 PIC16C62A/R62/64A/R64-10 (Commercial, Industrial, Extended)
 PIC16C62A/R62/64A/R64-20 (Commercial, Industrial, Extended)
 PIC16LC62A/R62/64A/R64-04 (Commercial, Industrial)

DC CHARACTERISTICS		Standard Operating Conditions (unless otherwise stated)					
		Operating temperature -40°C ≤ TA ≤ +125°C for extended, -40°C ≤ TA ≤ +85°C for industrial and 0°C ≤ TA ≤ +70°C for commercial Operating voltage VDD range as described in DC spec Section 18.1 and Section 18.2					
Param No.	Characteristic	Sym	Min	Typ †	Max	Units	Conditions
D030 D030A D031 D032 D033	Input Low Voltage I/O ports with TTL buffer with Schmitt Trigger buffer MCLR, OSC1 (in RC mode) OSC1 (in XT, HS and LP)	VIL	VSS VSS VSS VSS	- - - -	0.15VDD 0.8V 0.2VDD 0.2VDD 0.3VDD	V V V V V	For entire VDD range 4.5V ≤ VDD ≤ 5.5V Note1
D040 D040A D041 D042 D042A D043 D070	Input High Voltage I/O ports with TTL buffer with Schmitt Trigger buffer MCLR OSC1 (XT, HS and LP) OSC1 (in RC mode) PORTB weak pull-up current	VIH	2.0 0.25VDD + 0.8V 0.8VDD 0.8VDD 0.7VDD 0.9VDD 50	- - - - - - - 250	VDD VDD VDD VDD VDD VDD VDD 400	V V V V V V V μA	4.5V ≤ VDD ≤ 5.5V For entire VDD range For entire VDD range Note1 VDD = 5V, VPIN = VSS
D060 D061 D063	Input Leakage Current (Notes 2, 3) I/O ports MCLR, RA4/T0CK1 OSC1	IIL	- - -	- - -	±1 ±5 ±5	μA μA μA	VSS ≤ VPIN ≤ VDD, Pin at hi-impedance VSS ≤ VPIN ≤ VDD VSS ≤ VPIN ≤ VDD, XT, HS and LP osc configuration
D080 D080A D083 D083A	Output Low Voltage I/O ports OSC2/CLKOUT (RC osc config)	VOL	- - - -	- - - -	0.6 0.6 0.6 0.6	V V V V	IOL = 8.5 mA, VDD = 4.5V, -40°C to +85°C IOL = 7.0 mA, VDD = 4.5V, -40°C to +125°C IOL = 1.6 mA, VDD = 4.5V, -40°C to +85°C IOL = 1.2 mA, VDD = 4.5V, -40°C to +125°C

* These parameters are characterized but not tested.

† Data in "Typ" column is at 5V, 25°C unless otherwise stated. These parameters are for design guidance only and are not tested.

- Note 1: In RC oscillator configuration, the OSC1/CLKIN pin is a Schmitt Trigger input. It is not recommended that the PIC16C6X be driven with external clock in RC mode.
- 2: The leakage current on the MCLR/VPP pin is strongly dependent on the applied voltage level. The specified levels represent normal operating conditions. Higher leakage current may be measured at different input voltages.
- 3: Negative current is defined as current sourced by the pin.

PIC16C6X

Applicable Devices 61 62 62A R62 63 R63 64 64A R64 65 65A R65 66 67

Standard Operating Conditions (unless otherwise stated)							
DC CHARACTERISTICS Operating temperature $-40^{\circ}\text{C} \leq T_A \leq +125^{\circ}\text{C}$ for extended, $-40^{\circ}\text{C} \leq T_A \leq +85^{\circ}\text{C}$ for industrial and $0^{\circ}\text{C} \leq T_A \leq +70^{\circ}\text{C}$ for commercial Operating voltage VDD range as described in DC spec Section 18.1 and Section 18.2							
Param No.	Characteristic	Sym	Min	Typ †	Max	Units	Conditions
D090	Output High Voltage I/O ports (Note 3)	VOH	VDD-0.7	-	-	V	IOH = -3.0 mA, VDD = 4.5V, -40°C to +85°C
D090A			VDD-0.7	-	-	V	IOH = -2.5 mA, VDD = 4.5V, -40°C to +125°C
D092	OSC2/CLKOUT (RC osc config)		VDD-0.7	-	-	V	IOH = -1.3 mA, VDD = 4.5V, -40°C to +85°C
D092A			VDD-0.7	-	-	V	IOH = -1.0 mA, VDD = 4.5V, -40°C to +125°C
D150*	Open-Drain High Voltage	VOD	-	-	14	V	RA4 pin
Capacitive Loading Specs on Output Pins							
D100	OSC2 pin	COSC2	-	-	15	pF	In XT, HS and LP modes when external clock is used to drive OSC1.
D101	All I/O pins and OSC2 (in RC mode)	CIO	-	-	50	pF	
D102	SCL, SDA in I ² C mode	Cb	-	-	400	pF	

* These parameters are characterized but not tested.

† Data in "Typ" column is at 5V, 25°C unless otherwise stated. These parameters are for design guidance only and are not tested.

- Note 1: In RC oscillator configuration, the OSC1/CLKIN pin is a Schmitt Trigger input. It is not recommended that the PIC16C6X be driven with external clock in RC mode.
- 2: The leakage current on the $\overline{\text{MCLR}}/\text{VPP}$ pin is strongly dependent on the applied voltage level. The specified levels represent normal operating conditions. Higher leakage current may be measured at different input voltages.
- 3: Negative current is defined as current sourced by the pin.

PIC16C6X

Applicable Devices [61](#) [62](#) [62A](#) [R62](#) [63](#) [R63](#) [64](#) [64A](#) [R64](#) [65](#) [65A](#) [R65](#) [66](#) [67](#)

18.4 Timing Parameter Symbology

The timing parameter symbols have been created following one of the following formats:

1. TppS2ppS
2. TppS
3. TCC:ST (I²C specifications only)
4. Ts (I²C specifications only)

T			
F	Frequency	T	Time

Lowercase letters (pp) and their meanings:

pp			
cc	CCP1	osc	OSC1
ck	CLKOUT	rd	\overline{RD}
cs	\overline{CS}	rw	\overline{RD} or \overline{WR}
di	SDI	sc	SCK
do	SDO	ss	\overline{SS}
dt	Data in	t0	T0CKI
io	I/O port	t1	T1CKI
mc	\overline{MCLR}	wr	\overline{WR}

Uppercase letters and their meanings:

S			
F	Fall	P	Period
H	High	R	Rise
I	Invalid (Hi-impedance)	V	Valid
L	Low	Z	Hi-impedance
I²C only			
AA	output access	High	High
BUF	Bus free	Low	Low

TCC:ST (I²C specifications only)

CC			
HD	Hold	SU	Setup
ST			
DAT	DATA input hold	STO	STOP condition
STA	START condition		

FIGURE 18-1: LOAD CONDITIONS FOR DEVICE TIMING SPECIFICATIONS



18.5 Timing Diagrams and Specifications

FIGURE 18-2: EXTERNAL CLOCK TIMING



TABLE 18-2: EXTERNAL CLOCK TIMING REQUIREMENTS

Parameter No.	Sym	Characteristic	Min	Typ†	Max	Units	Conditions	
	Fosc	External CLKIN Frequency (Note 1)	DC	—	4	MHz	XT and RC osc mode	
			DC	—	4	MHz	HS osc mode (-04)	
			DC	—	10	MHz	HS osc mode (-10)	
			DC	—	20	MHz	HS osc mode (-20)	
			DC	—	200	kHz	LP osc mode	
		Tosc	Oscillator Frequency (Note 1)	DC	—	4	MHz	RC osc mode
				0.1	—	4	MHz	XT osc mode
				4	—	20	MHz	HS osc mode
				5	—	200	kHz	LP osc mode
				1	Tosc	External CLKIN Period (Note 1)	250	—
250	—	—	ns				HS osc mode (-04)	
100	—	—	ns				HS osc mode (-10)	
50	—	—	ns				HS osc mode (-20)	
5	—	—	μs				LP osc mode	
	Tosc	Oscillator Period (Note 1)	250		—	—	ns	RC osc mode
			250		—	10,000	ns	XT osc mode
			250		—	250	ns	HS osc mode (-04)
			100		—	250	ns	HS osc mode (-10)
			50		—	250	ns	HS osc mode (-20)
5	—	—	μs	LP osc mode				
2	T _{CY}	Instruction Cycle Time (Note 1)	200	T _{CY}	DC	ns	T _{CY} = 4/Fosc	
3	TosL, TosH	External Clock in (OSC1) High or Low Time	100	—	—	ns	XT oscillator	
			2.5	—	—	μs	LP oscillator	
			15	—	—	ns	HS oscillator	
4	TosR, TosF	External Clock in (OSC1) Rise or Fall Time	—	—	25	ns	XT oscillator	
			—	—	50	ns	LP oscillator	
			—	—	15	ns	HS oscillator	

† Data in "Typ" column is at 5V, 25°C unless otherwise stated. These parameters are for design guidance only and are not tested.

Note 1: Instruction cycle period (T_{CY}) equals four times the input oscillator time-base period. All specified values are based on characterization data for that particular oscillator type under standard operating conditions with the device executing code. Exceeding these specified limits may result in an unstable oscillator operation and/or higher than expected current consumption. All devices are tested to operate at "min." values with an external clock applied to the OSC1/CLKIN pin. When an external clock input is used, the "Max." cycle time limit is "DC" (no clock) for all devices.

PIC16C6X

Applicable Devices 61 62 62A R62 63 R63 64 64A R64 65 65A R65 66 67

FIGURE 18-3: CLKOUT AND I/O TIMING



TABLE 18-3: CLKOUT AND I/O TIMING REQUIREMENTS

Parameters	Sym	Characteristic	Min	Typ†	Max	Units	Conditions	
10*	TosH2ckL	OSC1↑ to CLKOUT↓	—	75	200	ns	Note 1	
11*	TosH2ckH	OSC1↑ to CLKOUT↑	—	75	200	ns	Note 1	
12*	TckR	CLKOUT rise time	—	35	100	ns	Note 1	
13*	TckF	CLKOUT fall time	—	35	100	ns	Note 1	
14*	TckL2ioV	CLKOUT ↓ to Port out valid	—	—	0.5T _{CY} + 20	ns	Note 1	
15*	TioV2ckH	Port in valid before CLKOUT ↑	T _{osc} + 200	—	—	ns	Note 1	
16*	TckH2ioL	Port in hold after CLKOUT ↑	0	—	—	ns	Note 1	
17*	TosH2ioV	OSC1↑ (Q1 cycle) to Port out valid	—	50	150	ns		
18*	TosH2ioL	OSC1↑ (Q2 cycle) to Port input invalid (I/O in hold time)	PIC16C62A/R62/64A/R64	100	—	—	ns	
			PIC16LC62A/R62/64A/R64	200	—	—	ns	
19*	TioV2osH	Port input valid to OSC1↑ (I/O in setup time)	0	—	—	ns		
20*	TioR	Port output rise time	PIC16C62A/R62/64A/R64	—	10	40	ns	
			PIC16LC62A/R62/64A/R64	—	—	80	ns	
21*	TioF	Port output fall time	PIC16C62A/R62/64A/R64	—	10	40	ns	
			PIC16LC62A/R62/64A/R64	—	—	80	ns	
22††*	Tinp	RB0/INT pin high or low time	T _{CY}	—	—	ns		
23††*	Trbp	RB7:RB4 change int high or low time	T _{CY}	—	—	ns		

* These parameters are characterized but not tested.

† Data in "Typ" column is at 5V, 25°C unless otherwise stated. These parameters are for design guidance only and are not tested.

†† These parameters are asynchronous events not related to any internal clock edge.

Note 1: Measurements are taken in RC Mode where CLKOUT output is 4 x T_{OSC}.

FIGURE 18-4: RESET, WATCHDOG TIMER, OSCILLATOR START-UP TIMER AND POWER-UP TIMER TIMING



FIGURE 18-5: BROWN-OUT RESET TIMING



TABLE 18-4: RESET, WATCHDOG TIMER, OSCILLATOR START-UP TIMER, POWER-UP TIMER, AND BROWN-OUT RESET REQUIREMENTS

Parameter No.	Sym	Characteristic	Min	Typ†	Max	Units	Conditions
30	Tmcl	MCLR Pulse Width (low)	2	—	—	μs	VDD = 5V, -40°C to +125°C
31*	Twdt	Watchdog Timer Time-out Period (No Prescaler)	7	18	33	ms	VDD = 5V, -40°C to +125°C
32	Tost	Oscillation Start-up Timer Period	—	1024Tosc	—	—	TOSC = OSC1 period
33*	Tpwrt	Power-up Timer Period	28	72	132	ms	VDD = 5V, -40°C to +125°C
34	Tioz	I/O Hi-impedance from MCLR Low or WDT Reset	—	—	2.1	μs	
35	TBOR	Brown-out Reset Pulse Width	100	—	—	μs	VDD ≤ BVDD (param. D005)

* These parameters are characterized but not tested.

† Data in "Typ" column is at 5V, 25°C unless otherwise stated. These parameters are for design guidance only and are not tested.

PIC16C6X

Applicable Devices 61 62 62A R62 63 R63 64 64A R64 65 65A R65 66 67

FIGURE 18-6: TIMER0 AND TIMER1 EXTERNAL CLOCK TIMINGS



TABLE 18-5: TIMER0 AND TIMER1 EXTERNAL CLOCK REQUIREMENTS

Param No.	Sym	Characteristic		Min	Typ†	Max	Units	Conditions	
40*	Tt0H	T0CKI High Pulse Width	No Prescaler	$0.5T_{CY} + 20$	—	—	ns	Must also meet parameter 42	
			With Prescaler	10	—	—	ns		
41*	Tt0L	T0CKI Low Pulse Width	No Prescaler	$0.5T_{CY} + 20$	—	—	ns	Must also meet parameter 42	
			With Prescaler	10	—	—	ns		
42*	Tt0P	T0CKI Period	No Prescaler	$T_{CY} + 40$	—	—	ns	N = prescale value (2, 4, ..., 256)	
			With Prescaler	Greater of: 20 or $T_{CY} + 40$ N	—	—	ns		
45*	Tt1H	T1CKI High Time	Synchronous, Prescaler = 1	$0.5T_{CY} + 20$	—	—	ns	Must also meet parameter 47	
			Synchronous, Prescaler = 2,4,8	PIC16C6X	15	—	—		ns
				PIC16LC6X	25	—	—		ns
			Asynchronous	PIC16C6X	30	—	—		ns
			PIC16LC6X	50	—	—	ns		
46*	Tt1L	T1CKI Low Time	Synchronous, Prescaler = 1	$0.5T_{CY} + 20$	—	—	ns	Must also meet parameter 47	
			Synchronous, Prescaler = 2,4,8	PIC16C6X	15	—	—		ns
				PIC16LC6X	25	—	—		ns
			Asynchronous	PIC16C6X	30	—	—		ns
			PIC16LC6X	50	—	—	ns		
47*	Tt1P	T1CKI input period	Synchronous	PIC16C6X	Greater of: 30 OR $T_{CY} + 40$ N	—	—	ns	N = prescale value (1, 2, 4, 8)
				PIC16LC6X	Greater of: 50 OR $T_{CY} + 40$ N				N = prescale value (1, 2, 4, 8)
			Asynchronous	PIC16C6X	60	—	—	ns	
				PIC16LC6X	100	—	—	ns	
	Ft1	Timer1 oscillator input frequency range (oscillator enabled by setting bit T1OSCEN)		DC	—	200	kHz		
48	TCKEZTmr1	Delay from external clock edge to timer increment		$2T_{osc}$	—	$7T_{osc}$	—		

* These parameters are characterized but not tested.

† Data in "Typ" column is at 5V, 25°C unless otherwise stated. These parameters are for design guidance only and are not tested.

FIGURE 18-7: CAPTURE/COMPARE/PWM TIMINGS (CCP1)

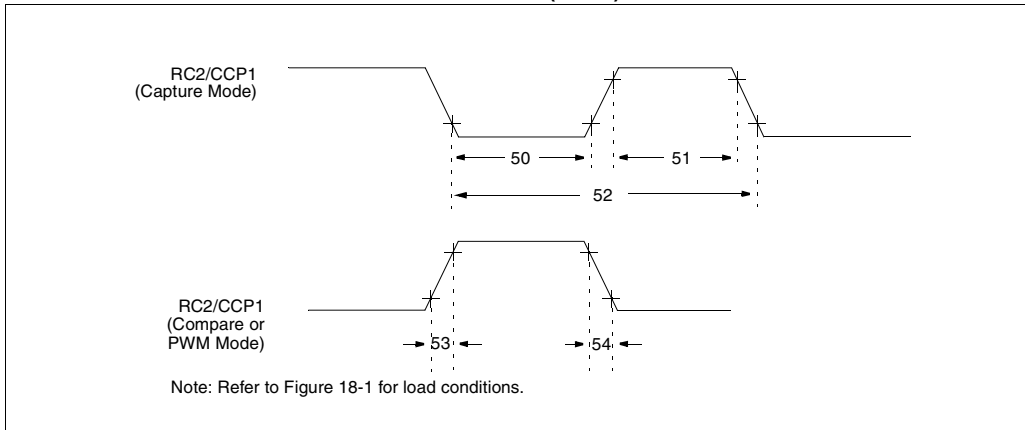

TABLE 18-6: CAPTURE/COMPARE/PWM REQUIREMENTS (CCP1)

Parameter No.	Sym	Characteristic		Min	Typ†	Max	Units	Conditions	
50*	TccL	CCP1 input low time	No Prescaler	$0.5T_{CY} + 20$	—	—	ns		
			With Prescaler	PIC16C62A/R62/64A/R64	10	—	—		ns
				PIC16LC62A/R62/64A/R64	20	—	—		ns
51*	TccH	CCP1 input high time	No Prescaler	$0.5T_{CY} + 20$	—	—	ns		
			With Prescaler	PIC16C62A/R62/64A/R64	10	—	—		ns
				PIC16LC62A/R62/64A/R64	20	—	—		ns
52*	TccP	CCP1 input period		$\frac{3T_{CY} + 40}{N}$	—	—	ns	N = prescale value (1, 4 or 16)	
53*	TccR	CCP1 output rise time	PIC16C62A/R62/64A/R64	—	10	25	ns		
			PIC16LC62A/R62/64A/R64	—	25	45	ns		
54*	TccF	CCP1 output fall time	PIC16C62A/R62/64A/R64	—	10	25	ns		
			PIC16LC62A/R62/64A/R64	—	25	45	ns		

* These parameters are characterized but not tested.

† Data in "Typ" column is at 5V, 25°C unless otherwise stated. These parameters are for design guidance only and are not tested.

PIC16C6X

Applicable Devices 61 62 62A R62 63 R63 64 64A R64 65 65A R65 66 67

FIGURE 18-8: PARALLEL SLAVE PORT TIMING (PIC16C64A/R64)



TABLE 18-7: PARALLEL SLAVE PORT REQUIREMENTS (PIC16C64A/R64)

Parameter No.	Sym	Characteristic	Min	Typ†	Max	Units	Conditions	
62	TdtV2wrH	Data in valid before $\overline{WR}\uparrow$ or $\overline{CS}\uparrow$ (setup time)	20	—	—	ns	Extended Range Only	
			25	—	—	ns		
63*	TwrH2dtI	$\overline{WR}\uparrow$ or $\overline{CS}\uparrow$ to data-in invalid (hold time)	PIC16C64A/R64	20	—	—	ns	
			PIC16LC64A.R64	35	—	—	ns	
64	TrdL2dtV	$\overline{RD}\downarrow$ and $\overline{CS}\downarrow$ to data-out valid	—	—	80	ns	Extended Range Only	
			—	—	90	ns		
65*	TrdH2dtI	$\overline{RD}\uparrow$ or $\overline{CS}\uparrow$ to data-out invalid	10	—	30	ns		

* These parameters are characterized but not tested.

† Data in "Typ" column is at 5V, 25°C unless otherwise stated. These parameters are for design guidance only and are not tested.

FIGURE 18-9: SPI MODE TIMING



TABLE 18-8: SPI MODE REQUIREMENTS

Parameter No.	Sym	Characteristic	Min	Typ†	Max	Units	Conditions
70*	Tssl2scH, Tssl2scL	$\overline{SS}\downarrow$ to SCK \downarrow or SCK \uparrow input	T _{CY}	—	—	ns	
71*	TscH	SCK input high time (slave mode)	T _{CY} + 20	—	—	ns	
72*	TscL	SCK input low time (slave mode)	T _{CY} + 20	—	—	ns	
73*	TdiV2scH, TdiV2scL	Setup time of SDI data input to SCK edge	50	—	—	ns	
74*	Tsch2diL, TscL2diL	Hold time of SDI data input to SCK edge	50	—	—	ns	
75*	TdoR	SDO data output rise time	—	10	25	ns	
76*	TdoF	SDO data output fall time	—	10	25	ns	
77*	TssH2doZ	$\overline{SS}\uparrow$ to SDO output hi-impedance	10	—	50	ns	
78*	TscR	SCK output rise time (master mode)	—	10	25	ns	
79*	TscF	SCK output fall time (master mode)	—	10	25	ns	
80*	Tsch2doV, TscL2doV	SDO data output valid after SCK edge	—	—	50	ns	

* These parameters are characterized but not tested.

† Data in "Typ" column is at 5V, 25°C unless otherwise stated. These parameters are for design guidance only and are not tested.

PIC16C6X

Applicable Devices 61 62 62A R62 63 R63 64 64A R64 65 65A R65 66 67

FIGURE 18-10: I²C BUS START/STOP BITS TIMING



TABLE 18-9: I²C BUS START/STOP BITS REQUIREMENTS

Parameter No.	Sym	Characteristic	Min	Typ	Max	Units	Conditions	
90*	TSU:STA	START condition Setup time	100 kHz mode	4700	—	—	ns	Only relevant for repeated START condition
		400 kHz mode	600	—	—			
91*	THD:STA	START condition Hold time	100 kHz mode	4000	—	—	ns	After this period the first clock pulse is generated
		400 kHz mode	600	—	—			
92*	TSU:STO	STOP condition Setup time	100 kHz mode	4700	—	—	ns	
		400 kHz mode	600	—	—			
93*	THD:STO	STOP condition Hold time	100 kHz mode	4000	—	—	ns	
		400 kHz mode	600	—	—			

*These parameters are characterized but not tested.

FIGURE 18-11: I²C BUS DATA TIMING



TABLE 18-10: I²C BUS DATA REQUIREMENTS

Parameter No.	Sym	Characteristic	Min	Max	Units	Conditions	
100*	THIGH	Clock high time	100 kHz mode	4.0	—	μs	Device must operate at a minimum of 1.5 MHz
			400 kHz mode	0.6	—	μs	Device must operate at a minimum of 10 MHz
			SSP Module	1.5T _{CY}	—		
101*	TLOW	Clock low time	100 kHz mode	4.7	—	μs	Device must operate at a minimum of 1.5 MHz
			400 kHz mode	1.3	—	μs	Device must operate at a minimum of 10 MHz
			SSP Module	1.5T _{CY}	—		
102*	TR	SDA and SCL rise time	100 kHz mode	—	1000	ns	
			400 kHz mode	20 + 0.1C _b	300	ns	C _b is specified to be from 10-400 pF
103*	TF	SDA and SCL fall time	100 kHz mode	—	300	ns	
			400 kHz mode	20 + 0.1C _b	300	ns	C _b is specified to be from 10-400 pF
90*	TSU:STA	START condition setup time	100 kHz mode	4.7	—	μs	Only relevant for repeated START condition
			400 kHz mode	0.6	—	μs	
91*	THD:STA	START condition hold time	100 kHz mode	4.0	—	μs	After this period the first clock pulse is generated
			400 kHz mode	0.6	—	μs	
106*	THD:DAT	Data input hold time	100 kHz mode	0	—	ns	
			400 kHz mode	0	0.9	μs	
107*	TSU:DAT	Data input setup time	100 kHz mode	250	—	ns	Note 2
			400 kHz mode	100	—	ns	
92*	TSU:STO	STOP condition setup time	100 kHz mode	4.7	—	μs	
			400 kHz mode	0.6	—	μs	
109*	TAA	Output valid from clock	100 kHz mode	—	3500	ns	Note 1
			400 kHz mode	—	—	ns	
110*	TBUF	Bus free time	100 kHz mode	4.7	—	μs	Time the bus must be free before a new transmission can start
			400 kHz mode	1.3	—	μs	
	C _b	Bus capacitive loading	—	400	pF		

* These parameters are characterized but not tested.

- Note 1: As a transmitter, the device must provide this internal minimum delay time to bridge the undefined region (min. 300 ns) of the falling edge of SCL to avoid unintended generation of START or STOP conditions.
- Note 2: A fast-mode (400 kHz) I²C-bus device can be used in a standard-mode (100 kHz) I²C-bus system, but the requirement tsu;DAT ≥ 250 ns must then be met. This will automatically be the case if the device does not stretch the LOW period of the SCL signal. If such a device does stretch the LOW period of the SCL signal, it must output the next data bit to the SDA line TR max.+tsu;DAT = 1000 + 250 = 1250 ns (according to the standard-mode I²C bus specification) before the SCL line is released.

PIC16C6X

Applicable Devices	61	62	62A	R62	63	R63	64	64A	R64	65	65A	R65	66	67
--------------------	----	----	-----	-----	----	-----	----	-----	-----	----	-----	-----	----	----

NOTES:

19.0 ELECTRICAL CHARACTERISTICS FOR PIC16C65

Absolute Maximum Ratings †

Ambient temperature under bias.....	-55°C to +85°C
Storage temperature	-65°C to +150°C
Voltage on any pin with respect to V _{SS} (except V _{DD} , $\overline{\text{MCLR}}$, and RA4).....	-0.3V to (V _{DD} + 0.3V)
Voltage on V _{DD} with respect to V _{SS}	-0.3V to +7.5V
Voltage on $\overline{\text{MCLR}}$ with respect to V _{SS} (Note 2).....	0V to +14V
Voltage on RA4 with respect to V _{SS}	0V to +14V
Total power dissipation (Note 1).....	1.0W
Maximum current out of V _{SS} pin	300 mA
Maximum current into V _{DD} pin	250 mA
Input clamp current, I _{IK} (V _I < 0 or V _I > V _{DD}).....	±20 mA
Output clamp current, I _{OK} (V _O < 0 or V _O > V _{DD})	±20 mA
Maximum output current sunk by any I/O pin.....	25 mA
Maximum output current sourced by any I/O pin	25 mA
Maximum current sunk by PORTA, PORTB, and PORTE (combined).....	200 mA
Maximum current sourced by PORTA, PORTB, and PORTE (combined)	200 mA
Maximum current sunk by PORTC and PORTD (combined)	200 mA
Maximum current sourced by PORTC and PORTD (combined).....	200 mA

Note 1: Power dissipation is calculated as follows: $P_{dis} = V_{DD} \times \{I_{DD} - \sum I_{OH}\} + \sum \{(V_{DD} - V_{OH}) \times I_{OH}\} + \sum (V_{OL} \times I_{OL})$

Note 2: Voltage spikes below V_{SS} at the $\overline{\text{MCLR}}$ pin, inducing currents greater than 80 mA, may cause latch-up. Thus, a series resistor of 50-100Ω should be used when applying a “low” level to the $\overline{\text{MCLR}}$ pin rather than pulling this pin directly to V_{SS}.

† NOTICE: Stresses above those listed under “Absolute Maximum Ratings” may cause permanent damage to the device. This is a stress rating only and functional operation of the device at those or any other conditions above those indicated in the operation listings of this specification is not implied. Exposure to maximum rating conditions for extended periods may affect device reliability.

TABLE 19-1: CROSS REFERENCE OF DEVICE SPECS FOR OSCILLATOR CONFIGURATIONS AND FREQUENCIES OF OPERATION (COMMERCIAL DEVICES)

OSC	PIC16C65-04	PIC16C65-10	PIC16C65-20	PIC16L65-04	JW Devices
RC	VDD: 4.0V to 6.0V IDD: 5 mA max. at 5.5V IPD: 21 μA max. at 4V Freq: 4 MHz max.	VDD: 4.5V to 5.5V IDD: 2.7 mA typ. at 5.5V IPD: 1.5 μA typ. at 4V Freq: 4 MHz max.	VDD: 4.5V to 5.5V IDD: 2.7 mA typ. at 5.5V IPD: 1.5 μA typ. at 4V Freq: 4 MHz max.	VDD: 3.0V to 6.0V IDD: 3.8 mA max. at 3V IPD: 800 μA max. at 3V Freq: 4 MHz max.	VDD: 4.0V to 6.0V IDD: 5 mA max. at 5.5V IPD: 21 μA max. at 4V Freq: 4 MHz max.
XT	VDD: 4.0V to 6.0V IDD: 5 mA max. at 5.5V IPD: 21 μA max. at 4V Freq: 4 MHz max.	VDD: 4.5V to 5.5V IDD: 2.7 mA typ. at 5.5V IPD: 1.5 μA typ. at 4V Freq: 4 MHz max.	VDD: 4.5V to 5.5V IDD: 2.7 mA typ. at 5.5V IPD: 1.5 μA typ. at 4V Freq: 4 MHz max.	VDD: 3.0V to 6.0V IDD: 3.8 mA max. at 3V IPD: 800 μA max. at 3V Freq: 4 MHz max.	VDD: 4.0V to 6.0V IDD: 5 mA max. at 5.5V IPD: 21 μA max. at 4V Freq: 4 MHz max.
HS	VDD: 4.5V to 5.5V IDD: 13.5 mA max. at 5.5V IPD: 1.5 μA typ. at 4.5V Freq: 4 MHz max.	VDD: 4.5V to 5.5V IDD: 15 mA max. at 5.5V IPD: 1.0 μA typ. at 4.5V Freq: 10 MHz max.	VDD: 4.5V to 5.5V IDD: 30 mA max. at 5.5V IPD: 1.5 μA typ. at 4.5V Freq: 20 MHz max.	Not recommended for use in HS mode	VDD: 4.5V to 5.5V IDD: 30 mA max. at 5.5V IPD: 1.5 μA typ. at 4.5V Freq: 20 MHz max.
LP	VDD: 4.0V to 6.0V IDD: 52.5 μA typ. at 32 kHz, 4.0V IPD: 0.9 μA typ. at 4.0V Freq: 200 kHz max.	Not recommended for use in LP mode	Not recommended for use in LP mode	VDD: 3.0V to 6.0V IDD: 105 μA max. at 32 kHz, 3.0V IPD: 800 μA max. at 3.0V Freq: 200 kHz max.	VDD: 3.0V to 6.0V IDD: 105 μA max. at 32 kHz, 3.0V IPD: 800 μA max. at 3.0V Freq: 200 kHz max.

The shaded sections indicate oscillator selections which are tested for functionality, but not for MIN/MAX specifications. It is recommended that the user select the device type that ensures the specifications required.

PIC16C6X

Applicable Devices 61 62 62A R62 63 R63 64 64A R64 65 65A R65 66 67

19.1 DC Characteristics: PIC16C65-04 (Commercial, Industrial) PIC16C65-10 (Commercial, Industrial) PIC16C65-20 (Commercial, Industrial)

Standard Operating Conditions (unless otherwise stated)							
DC CHARACTERISTICS							
		Operating temperature -40°C ≤ TA ≤ +85°C for industrial and 0°C ≤ TA ≤ +70°C for commercial					
Param No.	Characteristic	Sym	Min	Typ†	Max	Units	Conditions
D001 D001A	Supply Voltage	VDD	4.0 4.5	-	6.0 5.5	V V	XT, RC and LP osc configuration HS osc configuration
D002*	RAM Data Retention Voltage (Note 1)	VDR	-	1.5	-	V	
D003	VDD start voltage to ensure internal Power-on Reset signal	VPOR	-	VSS	-	V	See section on Power-on Reset for details
D004*	VDD rise rate to ensure internal Power-on Reset signal	SVDD	0.05	-	-	V/ms	See section on Power-on Reset for details
D010 D013	Supply Current (Note 2, 5)	IDD	- -	2.7 13.5	5 30	mA mA	XT, RC osc configuration FOSC = 4 MHz, VDD = 5.5V (Note 4) HS osc configuration FOSC = 20 MHz, VDD = 5.5V
D020 D021 D021A	Power-down Current (Note 3, 5)	IPD	- - -	10.5 1.5 1.5	800 800 800	μA μA μA	VDD = 4.0V, WDT enabled, -40°C to +85°C VDD = 4.0V, WDT disabled, -0°C to +70°C VDD = 4.0V, WDT disabled, -40°C to +85°C

* These parameters are characterized but not tested.

† Data in "Typ" column is at 5V, 25°C unless otherwise stated. These parameters are for design guidance only and are not tested.

Note 1: This is the limit to which VDD can be lowered without losing RAM data.

2: The supply current is mainly a function of the operating voltage and frequency. Other factors such as I/O pin loading and switching rate, oscillator type, internal code execution pattern, and temperature also have an impact on the current consumption.

The test conditions for all IDD measurements in active operation mode are:
OSC1 = external square wave, from rail to rail; all I/O pins tristated, pulled to VDD,
MCLR = VDD; WDT enabled/disabled as specified.

3: The power down current in SLEEP mode does not depend on the oscillator type. Power-down current is measured with the part in SLEEP mode, with all I/O pins in hi-impedance state and tied to VDD and VSS.

4: For RC osc configuration, current through Rext is not included. The current through the resistor can be estimated by the formula $I_r = V_{DD}/2R_{ext}$ (mA) with Rext in kOhm.

5: Timer1 oscillator (when enabled) adds approximately 20 μA to the specification. This value is from characterization and is for design guidance only. This is not tested.

19.2 DC Characteristics: PIC16LC65-04 (Commercial, Industrial)

DC CHARACTERISTICS		Standard Operating Conditions (unless otherwise stated)						Conditions
		Operating temperature -40°C ≤ TA ≤ +85°C for industrial and 0°C ≤ TA ≤ +70°C for commercial						
Param No.	Characteristic	Sym	Min	Typ†	Max	Units		
D001	Supply Voltage	VDD	3.0	-	6.0	V	LP, XT, RC osc configuration (DC - 4 MHz)	
D002*	RAM Data Retention Voltage (Note 1)	VDR	-	1.5	-	V		
D003	VDD start voltage to ensure internal Power-on Reset signal	VPOR	-	VSS	-	V	See section on Power-on Reset for details	
D004*	VDD rise rate to ensure internal Power-on Reset signal	SVDD	0.05	-	-	V/ms	See section on Power-on Reset for details	
D010	Supply Current (Note 2, 5)	IDD	-	2.0	3.8	mA	XT, RC osc configuration FOSC = 4 MHz, VDD = 3.0V (Note 4)	
D010A				22.5	105	μA		LP osc configuration FOSC = 32 kHz, VDD = 4.0V, WDT disabled
D020	Power-down Current (Note 3, 5)	IPD	-	7.5	800	μA	VDD = 3.0V, WDT enabled, -40°C to +85°C	
D021				0.9	800	μA	VDD = 3.0V, WDT disabled, 0°C to +70°C	
D021A				0.9	800	μA	VDD = 3.0V, WDT disabled, -40°C to +85°C	

* These parameters are characterized but not tested.

† Data in "Typ" column is at 5V, 25°C unless otherwise stated. These parameters are for design guidance only and are not tested.

Note 1: This is the limit to which VDD can be lowered without losing RAM data.

2: The supply current is mainly a function of the operating voltage and frequency. Other factors such as I/O pin loading and switching rate, oscillator type, internal code execution pattern, and temperature also have an impact on the current consumption.

The test conditions for all IDD measurements in active operation mode are:

OSC1 = external square wave, from rail to rail; all I/O pins tristated, pulled to VDD,

MCLR = VDD; WDT enabled/disabled as specified.

3: The power down current in SLEEP mode does not depend on the oscillator type. Power-down current is measured with the part in SLEEP mode, with all I/O pins in hi-impedance state and tied to VDD and VSS.

4: For RC osc configuration, current through Rext is not included. The current through the resistor can be estimated by the formula $I_r = V_{DD}/2R_{ext}$ (mA) with Rext in kOhm.

5: Timer1 oscillator (when enabled) adds approximately 20 μA to the specification. This value is from characterization and is for design guidance only. This is not tested.

PIC16C6X

Applicable Devices 61 62 62A R62 63 R63 64 64A R64 65 65A R65 66 67

19.3 DC Characteristics: **PIC16C65-04 (Commercial, Industrial)**
PIC16C65-10 (Commercial, Industrial)
PIC16C65-20 (Commercial, Industrial)
PIC16LC65-04 (Commercial, Industrial)

DC CHARACTERISTICS		Standard Operating Conditions (unless otherwise stated)					
		Operating temperature -40°C ≤ TA ≤ +85°C for industrial and 0°C ≤ TA ≤ +70°C for commercial Operating voltage VDD range as described in DC spec Section 19.1 and Section 19.2					
Param No.	Characteristic	Sym	Min	Typ †	Max	Units	Conditions
D030 D030A D031 D032 D033	Input Low Voltage I/O ports with TTL buffer with Schmitt Trigger buffer MCLR, OSC1 (in RC mode) OSC1 (in XT, HS and LP)	VIL	VSS VSS VSS VSS	- - - -	0.15VDD 0.8V 0.2VDD 0.2VDD 0.3VDD	V V V V V	For entire VDD range 4.5V ≤ VDD ≤ 5.5V Note1
D040 D040A D041 D042 D042A D043	Input High Voltage I/O ports with TTL buffer with Schmitt Trigger buffer MCLR OSC1 (XT, HS and LP) OSC1 (in RC mode)	VIH	2.0 0.25VDD+ 0.8V 0.8VDD 0.7 VDD 0.9VDD	- - - - - -	VDD VDD VDD VDD VDD VDD	V V V V V V	4.5V ≤ VDD ≤ 5.5V For entire VDD range For entire VDD range Note1
D070	PORTB weak pull-up current	IPURB	50	250	400	μA	VDD = 5V, VPIN = VSS
D060 D061 D063	Input Leakage Current (Notes 2, 3) I/O ports MCLR, RA4/T0CKI OSC1	IIL	- - -	- - -	±1 ±5 ±5	μA μA μA	VSS ≤ VPIN ≤ VDD, Pin at hi-impedance VSS ≤ VPIN ≤ VDD VSS ≤ VPIN ≤ VDD, XT, HS, and LP osc configuration
D080 D083	Output Low Voltage I/O ports OSC2/CLKOUT (RC osc config)	VOL	- -	- -	0.6 0.6	V V	IOI = 8.5 mA, VDD = 4.5V, -40°C to +85°C IOI = 1.6 mA, VDD = 4.5V, -40°C to +85°C
D090 D092	Output High Voltage I/O ports (Note 3) OSC2/CLKOUT (RC osc config)	VOH	VDD-0.7 VDD-0.7	- -	- -	V V	IOH = -3.0 mA, VDD = 4.5V, -40°C to +85°C IOH = -1.3 mA, VDD = 4.5V, -40°C to +85°C
D150*	Open-Drain High Voltage	VOD	-	-	14	V	RA4 pin

* These parameters are characterized but not tested.

† Data in "Typ" column is at 5V, 25°C unless otherwise stated. These parameters are for design guidance only and are not tested.

Note 1: In RC oscillator configuration, the OSC1/CLKIN pin is a Schmitt Trigger input. It is not recommended that the PIC16C6X be driven with external clock in RC mode.

2: The leakage current on the MCLR/VPP pin is strongly dependent on the applied voltage level. The specified levels represent normal operating conditions. Higher leakage current may be measured at different input voltages.

3: Negative current is defined as current sourced by the pin.

PIC16C6X

Applicable Devices 61 62 62A R62 63 R63 64 64A R64 65 65A R65 66 67

DC CHARACTERISTICS							
Standard Operating Conditions (unless otherwise stated)							
Operating temperature $-40^{\circ}\text{C} \leq T_A \leq +85^{\circ}\text{C}$ for industrial and $0^{\circ}\text{C} \leq T_A \leq +70^{\circ}\text{C}$ for commercial							
Operating voltage V_{DD} range as described in DC spec Section 19.1 and Section 19.2							
Param No.	Characteristic	Sym	Min	Typ †	Max	Units	Conditions
Capacitive Loading Specs on Output Pins							
D100	OSC2 pin	C _{OSC2}	-	-	15	pF	In XT, HS and LP modes when external clock is used to drive OSC1.
D101	All I/O pins and OSC2 (in RC mode)	C _{IO}	-	-	50	pF	
D102	SCL, SDA in I ² C mode	C _b	-	-	400	pF	

* These parameters are characterized but not tested.

† Data in "Typ" column is at 5V, 25°C unless otherwise stated. These parameters are for design guidance only and are not tested.

- Note 1: In RC oscillator configuration, the OSC1/CLKIN pin is a Schmitt Trigger input. It is not recommended that the PIC16C6X be driven with external clock in RC mode.
- 2: The leakage current on the $\overline{\text{MCLR}}/V_{PP}$ pin is strongly dependent on the applied voltage level. The specified levels represent normal operating conditions. Higher leakage current may be measured at different input voltages.
- 3: Negative current is defined as current sourced by the pin.

PIC16C6X

Applicable Devices 61 62 62A R62 63 R63 64 64A R64 65 65A R65 66 67

19.4 Timing Parameter Symbology

The timing parameter symbols have been created following one of the following formats:

1. TppS2ppS
2. TppS
3. TCC:ST (I²C specifications only)
4. Ts (I²C specifications only)

T			
F	Frequency	T	Time

Lowercase letters (pp) and their meanings:

pp			
cc	CCP1	osc	OSC1
ck	CLKOUT	rd	\overline{RD}
cs	\overline{CS}	rw	\overline{RD} or \overline{WR}
di	SDI	sc	SCK
do	SDO	ss	\overline{SS}
dt	Data in	t0	T0CKI
io	I/O port	t1	T1CKI
mc	\overline{MCLR}	wr	\overline{WR}

Uppercase letters and their meanings:

S			
F	Fall	P	Period
H	High	R	Rise
I	Invalid (Hi-impedance)	V	Valid
L	Low	Z	Hi-impedance
I²C only			
AA	output access	High	High
BUF	Bus free	Low	Low

TCC:ST (I²C specifications only)

CC			
HD	Hold	SU	Setup
ST			
DAT	DATA input hold	STO	STOP condition
STA	START condition		

FIGURE 19-1: LOAD CONDITIONS FOR DEVICE TIMING SPECIFICATIONS



19.5 Timing Diagrams and Specifications

FIGURE 19-2: EXTERNAL CLOCK TIMING



TABLE 19-2: EXTERNAL CLOCK TIMING REQUIREMENTS

Parameter No.	Sym	Characteristic	Min	Typ†	Max	Units	Conditions
	Fosc	External CLKIN Frequency (Note 1)	DC	—	4	MHz	XT and RC osc mode
			DC	—	4	MHz	HS osc mode (-04)
			DC	—	10	MHz	HS osc mode (-10)
			DC	—	20	MHz	HS osc mode (-20)
			DC	—	200	kHz	LP osc mode
		Oscillator Frequency (Note 1)	DC	—	4	MHz	RC osc mode
			0.1	—	4	MHz	XT osc mode
			4	—	20	MHz	HS osc mode
			5	—	200	kHz	LP osc mode
			1	Tosc	External CLKIN Period (Note 1)	250	—
250	—	—	ns			HS osc mode (-04)	
100	—	—	ns			HS osc mode (-10)	
50	—	—	ns			HS osc mode (-20)	
5	—	—	μs			LP osc mode	
	Oscillator Period (Note 1)	250	—		—	ns	RC osc mode
		250	—		10,000	ns	XT osc mode
		250	—		250	ns	HS osc mode (-04)
		100	—		250	ns	HS osc mode (-10)
		50	—		250	ns	HS osc mode (-20)
5	—	—	μs	LP osc mode			
2	TCY	Instruction Cycle Time (Note 1)	200	TCY	DC	ns	TCY = 4/Fosc
3	TosL, TosH	External Clock in (OSC1) High or Low Time	50	—	—	ns	XT oscillator
			2.5	—	—	μs	LP oscillator
			15	—	—	ns	HS oscillator
4	TosR, TosF	External Clock in (OSC1) Rise or Fall Time	—	—	25	ns	XT oscillator
			—	—	50	ns	LP oscillator
			—	—	15	ns	HS oscillator

† Data in "Typ" column is at 5V, 25°C unless otherwise stated. These parameters are for design guidance only and are not tested.

Note 1: Instruction cycle period (TCY) equals four times the input oscillator time-base period. All specified values are based on characterization data for that particular oscillator type under standard operating conditions with the device executing code. Exceeding these specified limits may result in an unstable oscillator operation and/or higher than expected current consumption. All devices are tested to operate at "min." values with an external clock applied to the OSC1/CLKIN pin. When an external clock input is used, the "Max." cycle time limit is "DC" (no clock) for all devices.

PIC16C6X

Applicable Devices 61 62 62A R62 63 R63 64 64A R64 65 65A R65 66 67

FIGURE 19-3: CLKOUT AND I/O TIMING



TABLE 19-3: CLKOUT AND I/O TIMING REQUIREMENTS

Parameter No.	Sym	Characteristic	Min	Typ†	Max	Units	Conditions	
10*	TosH2ckL	OSC1↑ to CLKOUT↓	—	75	200	ns	Note 1	
11*	TosH2ckH	OSC1↑ to CLKOUT↑	—	75	200	ns	Note 1	
12*	TckR	CLKOUT rise time	—	35	100	ns	Note 1	
13*	TckF	CLKOUT fall time	—	35	100	ns	Note 1	
14*	TckL2ioV	CLKOUT ↓ to Port out valid	—	—	0.5TCY + 20	ns	Note 1	
15*	TioV2ckH	Port in valid before CLKOUT ↑	0.25TCY + 25	—	—	ns	Note 1	
16*	TckH2ioI	Port in hold after CLKOUT ↑	0	—	—	ns	Note 1	
17*	TosH2ioV	OSC1↑ (Q1 cycle) to Port out valid	—	50	150	ns		
18*	TosH2ioI	OSC1↑ (Q2 cycle) to Port input invalid (I/O in hold time)	PIC16C65	100	—	—	ns	
			PIC16LC65	200	—	—	ns	
19*	TioV2osH	Port input valid to OSC1↑ (I/O in setup time)	0	—	—	ns		
20*	TioR	Port output rise time	PIC16C65	—	10	25	ns	
			PIC16LC65	—	—	60	ns	
21*	TioF	Port output fall time	PIC16C65	—	10	25	ns	
			PIC16LC65	—	—	60	ns	
22††*	Tinp	RB0/INT pin high or low time	TCY	—	—	ns		
23††*	Trbp	RB7:RB4 change int high or low time	TCY	—	—	ns		

* These parameters are characterized but not tested.

† Data in "Typ" column is at 5V, 25°C unless otherwise stated. These parameters are for design guidance only and are not tested.

†† These parameters are asynchronous events not related to any internal clock edge.

Note 1: Measurements are taken in RC Mode where CLKOUT output is 4 x TosC.

FIGURE 19-4: RESET, WATCHDOG TIMER, OSCILLATOR START-UP TIMER AND POWER-UP TIMER TIMING



TABLE 19-4: RESET, WATCHDOG TIMER, OSCILLATOR START-UP TIMER AND POWER-UP TIMER REQUIREMENTS

Parameter No.	Sym	Characteristic	Min	Typ†	Max	Units	Conditions
30*	Tmcl	MCLR Pulse Width (low)	100	—	—	ns	VDD = 5V, -40°C to +85°C
31*	Twdt	Watchdog Timer Time-out Period (No Prescaler)	7	18	33	ms	VDD = 5V, -40°C to +85°C
32	Tost	Oscillation Start-up Timer Period	—	1024Tosc	—	—	Tosc = OSC1 period
33*	Tpwrt	Power-up Timer Period or WDT reset	28	72	132	ms	VDD = 5V, -40°C to +85°C
34	Tioz	I/O Hi-impedance from MCLR Low	—	—	100	ns	

* These parameters are characterized but not tested.

† Data in "Typ" column is at 5V, 25°C unless otherwise stated. These parameters are for design guidance only and are not tested.

PIC16C6X

Applicable Devices 61 62 62A R62 63 R63 64 64A R64 65 65A R65 66 67

FIGURE 19-5: TIMER0 AND TIMER1 EXTERNAL CLOCK TIMINGS



TABLE 19-5: TIMER0 AND TIMER1 EXTERNAL CLOCK REQUIREMENTS

Param No.	Sym	Characteristic		Min	Typ†	Max	Units	Conditions	
40*	Tt0H	T0CKI High Pulse Width	No Prescaler	$0.5T_{CY} + 20$	—	—	ns	Must also meet parameter 42	
			With Prescaler	10	—	—	ns		
41*	Tt0L	T0CKI Low Pulse Width	No Prescaler	$0.5T_{CY} + 20$	—	—	ns	Must also meet parameter 42	
			With Prescaler	10	—	—	ns		
42*	Tt0P	T0CKI Period	No Prescaler	$T_{CY} + 40$	—	—	ns	N = prescale value (2, 4, ..., 256)	
			With Prescaler	Greater of: 20 or $T_{CY} + 40$ N	—	—	ns		
45*	Tt1H	T1CKI High Time	Synchronous, Prescaler = 1	$0.5T_{CY} + 20$	—	—	ns	Must also meet parameter 47	
			Synchronous, Prescaler = 2,4,8	PIC16C6X	15	—	—		ns
				PIC16LC6X	25	—	—		ns
46*	Tt1L	T1CKI Low Time	Synchronous, Prescaler = 1	$0.5T_{CY} + 20$	—	—	ns	Must also meet parameter 47	
			Synchronous, Prescaler = 2,4,8	PIC16C6X	15	—	—		ns
				PIC16LC6X	25	—	—		ns
47*	Tt1P	T1CKI input period	Synchronous	PIC16C6X	Greater of: 30 OR $T_{CY} + 40$ N	—	—	ns	N = prescale value (1, 2, 4, 8)
				PIC16LC6X	Greater of: 50 OR $T_{CY} + 40$ N				N = prescale value (1, 2, 4, 8)
			Asynchronous	PIC16C6X	60	—	—	ns	
			PIC16LC6X	100	—	—	ns		
	Ft1	Timer1 oscillator input frequency range (oscillator enabled by setting bit T1OSCEN)		DC	—	200	kHz		
48	TCKEZtmr1	Delay from external clock edge to timer increment		$2T_{osc}$	—	$7T_{osc}$	—		

* These parameters are characterized but not tested.

† Data in "Typ" column is at 5V, 25°C unless otherwise stated. These parameters are for design guidance only and are not tested.

FIGURE 19-6: CAPTURE/COMPARE/PWM TIMINGS (CCP1 AND CCP2)



TABLE 19-6: CAPTURE/COMPARE/PWM REQUIREMENTS (CCP1 AND CCP2)

Parameter No.	Sym	Characteristic		Min	Typ†	Max	Units	Conditions	
50*	TccL	CCP1 and CCP2 input low time	No Prescaler	$0.5T_{CY} + 20$	—	—	ns		
			With Prescaler	PIC16C65	10	—	—		ns
				PIC16LC65	20	—	—		ns
51*	TccH	CCP1 and CCP2 input high time	No Prescaler	$0.5T_{CY} + 20$	—	—	ns		
			With Prescaler	PIC16C65	10	—	—		ns
				PIC16LC65	20	—	—		ns
52*	TccP	CCP1 and CCP2 input period		$\frac{3T_{CY} + 40}{N}$	—	—	ns	N = prescale value (1, 4, or 16)	
53	TccR	CCP1 and CCP2 output rise time	PIC16C65	—	10	25	ns		
			PIC16LC65	—	25	45	ns		
54	TccF	CCP1 and CCP2 output fall time	PIC16C65	—	10	25	ns		
			PIC16LC65	—	25	45	ns		

* These parameters are characterized but not tested.

† Data in "Typ" column is at 5V, 25°C unless otherwise stated. These parameters are for design guidance only and are not tested.

PIC16C6X

Applicable Devices 61 62 62A R62 63 R63 64 64A R64 65 65A R65 66 67

FIGURE 19-7: PARALLEL SLAVE PORT TIMING



TABLE 19-7: PARALLEL SLAVE PORT REQUIREMENTS

Parameter No.	Sym	Characteristic	Min	Typ†	Max	Units	Conditions	
62	TdtV2wrH	Data in valid before $\overline{WR}\uparrow$ or $\overline{CS}\uparrow$ (setup time)	20	—	—	ns		
63*	TwrH2dtl	$\overline{WR}\uparrow$ or $\overline{CS}\uparrow$ to data-in invalid (hold time)	PIC16C65	20	—	—	ns	
			PIC16LC65	35	—	—	ns	
64	TrdL2dtV	$\overline{RD}\downarrow$ and $\overline{CS}\downarrow$ to data-out valid	—	—	80	ns		
65	TrdH2dtl	$\overline{RD}\uparrow$ or $\overline{CS}\uparrow$ to data-out invalid	10	—	30	ns		

* These parameters are characterized but not tested.

† Data in "Typ" column is at 5V, 25°C unless otherwise stated. These parameters are for design guidance only and are not tested.

FIGURE 19-8: SPI MODE TIMING



TABLE 19-8: SPI MODE REQUIREMENTS

Parameter No.	Sym	Characteristic	Min	Typ†	Max	Units	Conditions
70	TssL2scH, TssL2scL	$\overline{SS}\downarrow$ to SCK \downarrow or SCK \uparrow input	T _{CY}	—	—	ns	
71	TscH	SCK input high time (slave mode)	T _{CY} + 20	—	—	ns	
72	TscL	SCK input low time (slave mode)	T _{CY} + 20	—	—	ns	
73	TdiV2scH, TdiV2scL	Setup time of SDI data input to SCK edge	50	—	—	ns	
74	Tsch2diL, TscL2diL	Hold time of SDI data input to SCK edge	50	—	—	ns	
75	TdoR	SDO data output rise time	—	10	25	ns	
76	TdoF	SDO data output fall time	—	10	25	ns	
77	TssH2doZ	$\overline{SS}\uparrow$ to SDO output hi-impedance	10	—	50	ns	
78	TscR	SCK output rise time (master mode)	—	10	25	ns	
79	TscF	SCK output fall time (master mode)	—	10	25	ns	
80	Tsch2doV, TscL2doV	SDO data output valid after SCK edge	—	—	50	ns	

† Data in "Typ" column is at 5V, 25°C unless otherwise stated. These parameters are for design guidance only and are not tested.

PIC16C6X

Applicable Devices 61 62 62A R62 63 R63 64 64A R64 65 65A R65 66 67

FIGURE 19-9: I²C BUS START/STOP BITS TIMING



TABLE 19-9: I²C BUS START/STOP BITS REQUIREMENTS

Parameter No.	Sym	Characteristic	Min	Typ	Max	Units	Conditions	
90	TSU:STA	START condition Setup time	100 kHz mode	4700	—	—	ns	Only relevant for repeated START condition
		400 kHz mode	600	—	—			
91	THD:STA	START condition Hold time	100 kHz mode	4000	—	—	ns	After this period the first clock pulse is generated
		400 kHz mode	600	—	—			
92	TSU:STO	STOP condition Setup time	100 kHz mode	4700	—	—	ns	
		400 kHz mode	600	—	—			
93	THD:STO	STOP condition Hold time	100 kHz mode	4000	—	—	ns	
		400 kHz mode	600	—	—			

FIGURE 19-10: I²C BUS DATA TIMING



TABLE 19-10: I²C BUS DATA REQUIREMENTS

Parameter No.	Sym	Characteristic	Min	Max	Units	Conditions	
100	THIGH	Clock high time	100 kHz mode	4.0	—	μs	Device must operate at a minimum of 1.5 MHz
			400 kHz mode	0.6	—	μs	Device must operate at a minimum of 10 MHz
			SSP Module	1.5TCY	—		
101	TLOW	Clock low time	100 kHz mode	4.7	—	μs	Device must operate at a minimum of 1.5 MHz
			400 kHz mode	1.3	—	μs	Device must operate at a minimum of 10 MHz
			SSP Module	1.5TCY	—		
102	Tr	SDA and SCL rise time	100 kHz mode	—	1000	ns	
			400 kHz mode	20 + 0.1Cb	300	ns	Cb is specified to be from 10-400 pF
103	TF	SDA and SCL fall time	100 kHz mode	—	300	ns	
			400 kHz mode	20 + 0.1Cb	300	ns	Cb is specified to be from 10-400 pF
90	TSU:STA	START condition setup time	100 kHz mode	4.7	—	μs	Only relevant for repeated START condition
			400 kHz mode	0.6	—	μs	
91	THD:STA	START condition hold time	100 kHz mode	4.0	—	μs	After this period the first clock pulse is generated
			400 kHz mode	0.6	—	μs	
106	THD:DAT	Data input hold time	100 kHz mode	0	—	ns	
			400 kHz mode	0	0.9	μs	
107	TSU:DAT	Data input setup time	100 kHz mode	250	—	ns	Note 2
			400 kHz mode	100	—	ns	
92	TSU:STO	STOP condition setup time	100 kHz mode	4.7	—	μs	
			400 kHz mode	0.6	—	μs	
109	TAA	Output valid from clock	100 kHz mode	—	3500	ns	Note 1
			400 kHz mode	—	—	ns	
110	TBUF	Bus free time	100 kHz mode	4.7	—	μs	Time the bus must be free before a new transmission can start
			400 kHz mode	1.3	—	μs	
	Cb	Bus capacitive loading	—	400	pF		

Note 1: As a transmitter, the device must provide this internal minimum delay time to bridge the undefined region (min. 300 ns) of the falling edge of SCL to avoid unintended generation of START or STOP conditions.

- A fast-mode (400 kHz) I²C-bus device can be used in a standard-mode (100 kHz) I²C-bus system, but the requirement tsu:DAT ≥ 250 ns must then be met. This will automatically be the case if the device does not stretch the LOW period of the SCL signal. If such a device does stretch the LOW period of the SCL signal, it must output the next data bit to the SDA line Tr max.+tsu:DAT = 1000 + 250 = 1250 ns (according to the standard-mode I²C bus specification) before the SCL line is released.

PIC16C6X

Applicable Devices 61 62 62A R62 63 R63 64 64A R64 65 65A R65 66 67

FIGURE 19-11: USART SYNCHRONOUS TRANSMISSION (MASTER/SLAVE) TIMING



TABLE 19-11: USART SYNCHRONOUS TRANSMISSION REQUIREMENTS

Parameter No.	Sym	Characteristic	Min	Typ†	Max	Units	Conditions	
120	TckH2dV	SYNC XMIT (MASTER & SLAVE)						
		Clock high to data out valid	PIC16C65	—	—	80	ns	
121	Tckrf	Clock out rise time and fall time (Master Mode)	PIC16C65	—	—	100	ns	
			PIC16LC65	—	—	50	ns	
122	Tdtfr	Data out rise time and fall time	PIC16C65	—	—	45	ns	
			PIC16LC65	—	—	50	ns	

†: Data in "Typ" column is at 5V, 25°C unless otherwise stated. These parameters are for design guidance only and are not tested.

FIGURE 19-12: USART SYNCHRONOUS RECEIVE (MASTER/SLAVE) TIMING



TABLE 19-12: USART SYNCHRONOUS RECEIVE REQUIREMENTS

Parameter No.	Sym	Characteristic	Min	Typ†	Max	Units	Conditions
125	TdtV2ckL	SYNC RCV (MASTER & SLAVE)					
		Data setup before CK ↓ (DT setup time)	15	—	—	ns	
126	TckL2dtl	Data hold after CK ↓ (DT hold time)	15	—	—	ns	

†: Data in "Typ" column is at 5V, 25°C unless otherwise stated. These parameters are for design guidance only and are not tested.

20.0 ELECTRICAL CHARACTERISTICS FOR PIC16C63/65A

Absolute Maximum Ratings (†)

Ambient temperature under bias.....	-55°C to +125°C
Storage temperature	-65°C to +150°C
Voltage on any pin with respect to V _{SS} (except V _{DD} , MCLR, and RA4).....	-0.3V to (V _{DD} + 0.3V)
Voltage on V _{DD} with respect to V _{SS}	-0.3V to +7.5V
Voltage on MCLR with respect to V _{SS} (Note 2).....	0V to +14V
Voltage on RA4 with respect to V _{SS}	0V to +14V
Total power dissipation (Note 1).....	1.0W
Maximum current out of V _{SS} pin	300 mA
Maximum current into V _{DD} pin	250 mA
Input clamp current, I _{IK} (V _I < 0 or V _I > V _{DD}).....	±20 mA
Output clamp current, I _{OK} (V _O < 0 or V _O > V _{DD})	±20 mA
Maximum output current sunk by any I/O pin.....	25 mA
Maximum output current sourced by any I/O pin	25 mA
Maximum current sunk by PORTA, PORTB, and PORTE (Note 3) (combined).....	200 mA
Maximum current sourced by PORTA, PORTB, and PORTE (Note 3) (combined)	200 mA
Maximum current sunk by PORTC and PORTD (Note 3) (combined)	200 mA
Maximum current sourced by PORTC and PORTD (Note 3) (combined)	200 mA

Note 1: Power dissipation is calculated as follows: $P_{dis} = V_{DD} \times \{I_{DD} - \sum I_{OH}\} + \sum \{(V_{DD} - V_{OH}) \times I_{OH}\} + \sum (V_{OL} \times I_{OL})$

Note 2: Voltage spikes below V_{SS} at the MCLR/VPP pin, inducing currents greater than 80 mA, may cause latch-up. Thus, a series resistor of 50-100Ω should be used when applying a “low” level to the MCLR/VPP pin rather than pulling this pin directly to V_{SS}.

Note 3: PORTD and PORTE not available on the PIC16C63.

† NOTICE: Stresses above those listed under “Absolute Maximum Ratings” may cause permanent damage to the device. This is a stress rating only and functional operation of the device at those or any other conditions above those indicated in the operation listings of this specification is not implied. Exposure to maximum rating conditions for extended periods may affect device reliability.

TABLE 20-1: CROSS REFERENCE OF DEVICE SPECS FOR OSCILLATOR CONFIGURATIONS AND FREQUENCIES OF OPERATION (COMMERCIAL DEVICES)

OSC	PIC16C63-04 PIC16C65A-04	PIC16C63-10 PIC16C65A-10	PIC16C63-20 PIC16C65A-20	PIC16LC63-04 PIC16LC65A-04	JW Devices
RC	V _{DD} : 4.0V to 6.0V I _{DD} : 5 mA max. at 5.5V I _{PD} : 16 μA max. at 4V Freq: 4 MHz max.	V _{DD} : 4.5V to 5.5V I _{DD} : 2.7 mA typ. at 5.5V I _{PD} : 1.5 μA typ. at 4V Freq: 4 MHz max.	V _{DD} : 4.5V to 5.5V I _{DD} : 2.7 mA typ. at 5.5V I _{PD} : 1.5 μA typ. at 4V Freq: 4 MHz max.	V _{DD} : 2.5V to 6.0V I _{DD} : 3.8 mA max. at 3V I _{PD} : 5 μA max. at 3V Freq: 4 MHz max.	V _{DD} : 4.0V to 6.0V I _{DD} : 5 mA max. at 5.5V I _{PD} : 16 μA max. at 4V Freq: 4 MHz max.
XT	V _{DD} : 4.0V to 6.0V I _{DD} : 5 mA max. at 5.5V I _{PD} : 16 μA max. at 4V Freq: 4 MHz max.	V _{DD} : 4.5V to 5.5V I _{DD} : 2.7 mA typ. at 5.5V I _{PD} : 1.5 μA typ. at 4V Freq: 4 MHz max.	V _{DD} : 4.5V to 5.5V I _{DD} : 2.7 mA typ. at 5.5V I _{PD} : 1.5 μA typ. at 4V Freq: 4 MHz max.	V _{DD} : 2.5V to 6.0V I _{DD} : 3.8 mA max. at 3V I _{PD} : 5 μA max. at 3V Freq: 4 MHz max.	V _{DD} : 4.0V to 6.0V I _{DD} : 5 mA max. at 5.5V I _{PD} : 16 μA max. at 4V Freq: 4 MHz max.
HS	V _{DD} : 4.5V to 5.5V I _{DD} : 13.5 mA typ. at 5.5V I _{PD} : 1.5 μA typ. at 4.5V Freq: 4 MHz max.	V _{DD} : 4.5V to 5.5V I _{DD} : 10 mA max. at 5.5V I _{PD} : 1.5 μA typ. at 4.5V Freq: 10 MHz max.	V _{DD} : 4.5V to 5.5V I _{DD} : 20 mA max. at 5.5V I _{PD} : 1.5 μA typ. at 4.5V Freq: 20 MHz max.	Not recommended for use in HS mode	V _{DD} : 4.5V to 5.5V I _{DD} : 20 mA max. at 5.5V I _{PD} : 1.5 μA typ. at 4.5V Freq: 20 MHz max.
LP	V _{DD} : 4.0V to 6.0V I _{DD} : 52.5 μA typ. at 32 kHz, 4.0V I _{PD} : 0.9 μA typ. at 4.0V Freq: 200 kHz max.	Not recommended for use in LP mode	Not recommended for use in LP mode	V _{DD} : 2.5V to 6.0V I _{DD} : 48 μA max. at 32 kHz, 3.0V I _{PD} : 5 μA max. at 3.0V Freq: 200 kHz max.	V _{DD} : 2.5V to 6.0V I _{DD} : 48 μA max. at 32 kHz, 3.0V I _{PD} : 5 μA max. at 3.0V Freq: 200 kHz max.

The shaded sections indicate oscillator selections which are tested for functionality, but not for MIN/MAX specifications. It is recommended that the user select the device type that ensures the specifications required.

PIC16C6X

Applicable Devices 61 62 62A R62 63 R63 64 64A R64 65 65A R65 66 67

20.1 DC Characteristics: PIC16C63/65A-04 (Commercial, Industrial, Extended) PIC16C63/65A-10 (Commercial, Industrial, Extended) PIC16C63/65A-20 (Commercial, Industrial, Extended)

DC CHARACTERISTICS		Standard Operating Conditions (unless otherwise stated)						
		Operating temperature						
		-40°C ≤ TA ≤ +125°C for extended,						
		-40°C ≤ TA ≤ +85°C for industrial and						
		0°C ≤ TA ≤ +70°C for commercial						
Param No.	Characteristic	Sym	Min	Typ†	Max	Units	Conditions	
D001 D001A	Supply Voltage	VDD	4.0 4.5	- -	6.0 5.5	V V	XT, RC and LP osc configuration HS osc configuration	
D002*	RAM Data Retention Voltage (Note 1)	VDR	-	1.5	-	V		
D003	VDD start voltage to ensure internal Power-on Reset signal	VPOR	-	VSS	-	V	See section on Power-on Reset for details	
D004*	VDD rise rate to ensure internal Power-on Reset signal	SVDD	0.05	-	-	V/ms	See section on Power-on Reset for details	
D005	Brown-out Reset Voltage	BVDD	3.7 3.7	4.0 4.0	4.3 4.4	V V	BODEN configuration bit is enabled Extended Range Only	
D010 D013	Supply Current (Note 2, 5)	IDD	- -	2.7 10	5 20	mA mA	XT, RC, osc config FOSC = 4 MHz, VDD = 5.5V (Note 4) HS osc config FOSC = 20 MHz, VDD = 5.5V	
D015*	Brown-out Reset Current (Note 6)	ΔIBOR	-	350	425	μA	BOR enabled, VDD = 5.0V	
D020 D021 D021A D021B	Power-down Current (Note 3, 5)	IPD	- - - -	10.5 1.5 1.5 2.5	42 16 19 19	μA μA μA μA	VDD = 4.0V, WDT enabled, -40°C to +85°C VDD = 4.0V, WDT disabled, -0°C to +70°C VDD = 4.0V, WDT disabled, -40°C to +85°C VDD = 4.0V, WDT disabled, -40°C to +125°C	
D023*	Brown-out Reset Current (Note 6)	ΔIBOR	-	350	425	μA	BOR enabled, VDD = 5.0V	

* These parameters are characterized but not tested.

† Data in "Typ" column is at 5V, 25°C unless otherwise stated. These parameters are for design guidance only and are not tested.

Note 1: This is the limit to which VDD can be lowered without losing RAM data.

2: The supply current is mainly a function of the operating voltage and frequency. Other factors such as I/O pin loading and switching rate, oscillator type, internal code execution pattern, and temperature also have an impact on the current consumption.

The test conditions for all IDD measurements in active operation mode are:
OSC1 = external square wave, from rail to rail; all I/O pins tristated, pulled to VDD,
MCLR = VDD; WDT enabled/disabled as specified.

3: The power down current in SLEEP mode does not depend on the oscillator type. Power-down current is measured with the part in SLEEP mode, with all I/O pins in hi-impedance state and tied to VDD and VSS.

4: For RC osc configuration, current through Rext is not included. The current through the resistor can be estimated by the formula $I_r = V_{DD}/2R_{ext}$ (mA) with Rext in kOhm.

5: Timer1 oscillator (when enabled) adds approximately 20 μA to the specification. This value is from characterization and is for design guidance only. This is not tested.

6: The Δ current is the additional current consumed when this peripheral is enabled. This current should be added to the base IDD or IPD measurement.

20.2 DC Characteristics: PIC16LC63/65A-04 (Commercial, Industrial)

DC CHARACTERISTICS		Standard Operating Conditions (unless otherwise stated)						Conditions
Param No.	Characteristic	Sym	Min	Typ†	Max	Units		
Operating temperature $-40^{\circ}\text{C} \leq T_A \leq +85^{\circ}\text{C}$ for industrial and $0^{\circ}\text{C} \leq T_A \leq +70^{\circ}\text{C}$ for commercial								
D001	Supply Voltage	VDD	2.5	-	6.0	V	LP, XT, RC osc configuration (DC - 4 MHz)	
D002*	RAM Data Retention Voltage (Note 1)	VDR	-	1.5	-	V		
D003	VDD start voltage to ensure internal Power-on Reset signal	VPOR	-	VSS	-	V	See section on Power-on Reset for details	
D004*	VDD rise rate to ensure internal Power-on Reset signal	SVDD	0.05	-	-	V/ms	See section on Power-on Reset for details	
D005	Brown-out Reset Voltage	BVDD	3.7	4.0	4.3	V	BODEN configuration bit is enabled	
D010	Supply Current (Note 2, 5)	IDD	-	2.0	3.8	mA	XT, RC osc configuration FOSC = 4 MHz, VDD = 3.0V (Note 4)	
D010A				22.5	48	μA	LP osc configuration FOSC = 32 kHz, VDD = 3.0V, WDT disabled	
D015*				350	425	μA	BOR enabled, VDD = 5.0V	
D020	Power-down Current (Note 3, 5)	IPD	-	7.5	30	μA	VDD = 3.0V, WDT enabled, -40°C to $+85^{\circ}\text{C}$	
D021				0.9	5	μA	VDD = 3.0V, WDT disabled, 0°C to $+70^{\circ}\text{C}$	
D021A				0.9	5	μA	VDD = 3.0V, WDT disabled, -40°C to $+85^{\circ}\text{C}$	
D023*	Brown-out Reset Current (Note 6)	ΔIBOR	-	350	425	μA	BOR enabled, VDD = 5.0V	

* These parameters are characterized but not tested.

† Data in "Typ" column is at 5V, 25°C unless otherwise stated. These parameters are for design guidance only and are not tested.

Note 1: This is the limit to which VDD can be lowered without losing RAM data.

2: The supply current is mainly a function of the operating voltage and frequency. Other factors such as I/O pin loading and switching rate, oscillator type, internal code execution pattern, and temperature also have an impact on the current consumption.

The test conditions for all IDD measurements in active operation mode are:

OSC1 = external square wave, from rail to rail; all I/O pins tristated, pulled to VDD,

MCLR = VDD; WDT enabled/disabled as specified.

3: The power-down current in SLEEP mode does not depend on the oscillator type. Power-down current is measured with the part in SLEEP mode, with all I/O pins in hi-impedance state and tied to VDD and VSS.

4: For RC osc configuration, current through Rext is not included. The current through the resistor can be estimated by the formula $I_r = V_{DD}/2R_{ext}$ (mA) with Rext in kOhm.

5: Timer1 oscillator (when enabled) adds approximately 20 μA to the specification. This value is from characterization and is for design guidance only. This is not tested.

6: The Δ current is the additional current consumed when this peripheral is enabled. This current should be added to the base IDD or IPD measurement.

PIC16C6X

Applicable Devices 61 62 62A R62 63 R63 64 64A R64 65 65A R65 66 67

20.3 DC Characteristics: **PIC16C63/65A-04 (Commercial, Industrial, Extended)**
PIC16C63/65A-10 (Commercial, Industrial, Extended)
PIC16C63/65A-20 (Commercial, Industrial, Extended)
PIC16LC63/65A-04 (Commercial, Industrial)

DC CHARACTERISTICS		Standard Operating Conditions (unless otherwise stated)					
		Operating temperature $-40^{\circ}\text{C} \leq T_A \leq +125^{\circ}\text{C}$ for extended, $-40^{\circ}\text{C} \leq T_A \leq +85^{\circ}\text{C}$ for industrial and $0^{\circ}\text{C} \leq T_A \leq +70^{\circ}\text{C}$ for commercial Operating voltage V_{DD} range as described in DC spec Section 20.1 and Section 20.2					
Param No.	Characteristic	Sym	Min	Typ †	Max	Units	Conditions
D030 D030A D031 D032 D033	Input Low Voltage I/O ports with TTL buffer with Schmitt Trigger buffer MCLR, OSC1 (in RC mode) OSC1 (in XT, HS and LP)	V_{IL}	V_{SS} V_{SS} V_{SS} V_{SS} V_{SS}	- - - - -	$0.15V_{DD}$ $0.8V$ $0.2V_{DD}$ $0.2V_{DD}$ $0.3V_{DD}$	V V V V V	For entire V_{DD} range $4.5V \leq V_{DD} \leq 5.5V$ Note1
D040 D040A D041 D042 D042A D043	Input High Voltage I/O ports with TTL buffer with Schmitt Trigger buffer MCLR OSC1 (XT, HS and LP) OSC1 (in RC mode)	V_{IH}	2.0 $0.25V_{DD} + 0.8V$ $0.8V_{DD}$ $0.7V_{DD}$ $0.9V_{DD}$	- - - - -	V_{DD} V_{DD} V_{DD} V_{DD} V_{DD}	V V V V V	$4.5V \leq V_{DD} \leq 5.5V$ For entire V_{DD} range For entire V_{DD} range Note1
D070	PORTB weak pull-up current	IPURB	50	250	400	μA	$V_{DD} = 5V, V_{PIN} = V_{SS}$
D060 D061 D063	Input Leakage Current (Notes 2, 3) I/O ports MCLR, RA4/T0CKI OSC1	I_{IL}	- - -	- - -	± 1 ± 5 ± 5	μA μA μA	$V_{SS} \leq V_{PIN} \leq V_{DD}$, Pin at hi-impedance $V_{SS} \leq V_{PIN} \leq V_{DD}$ $V_{SS} \leq V_{PIN} \leq V_{DD}$, XT, HS and LP osc configuration
D080 D080A D083 D083A	Output Low Voltage I/O ports OSC2/CLKOUT (RC osc config)	V_{OL}	- - - -	- - - -	0.6 0.6 0.6 0.6	V V V V	$I_{OL} = 8.5\text{ mA}$, $V_{DD} = 4.5V$, -40°C to $+85^{\circ}\text{C}$ $I_{OL} = 7.0\text{ mA}$, $V_{DD} = 4.5V$, -40°C to $+125^{\circ}\text{C}$ $I_{OL} = 1.6\text{ mA}$, $V_{DD} = 4.5V$, -40°C to $+85^{\circ}\text{C}$ $I_{OL} = 1.2\text{ mA}$, $V_{DD} = 4.5V$, -40°C to $+125^{\circ}\text{C}$

* These parameters are characterized but not tested.

† Data in "Typ" column is at 5V, 25°C unless otherwise stated. These parameters are for design guidance only and are not tested.

Note 1: In RC oscillator configuration, the OSC1/CLKIN pin is a Schmitt Trigger input. It is not recommended that the PIC16C6X be driven with external clock in RC mode.

2: The leakage current on the MCLR/VPP pin is strongly dependent on the applied voltage level. The specified levels represent normal operating conditions. Higher leakage current may be measured at different input voltages.

3: Negative current is defined as current sourced by the pin.

PIC16C6X

Applicable Devices 61 62 62A R62 63 R63 64 64A R64 65 65A R65 66 67

DC CHARACTERISTICS							
Standard Operating Conditions (unless otherwise stated)							
Operating temperature -40°C ≤ TA ≤ +125°C for extended, -40°C ≤ TA ≤ +85°C for industrial and 0°C ≤ TA ≤ +70°C for commercial							
Operating voltage VDD range as described in DC spec Section 20.1 and Section 20.2							
Param No.	Characteristic	Sym	Min	Typ †	Max	Units	Conditions
Output High Voltage							
D090	I/O ports (Note 3)	VOH	VDD-0.7	-	-	V	IOH = -3.0 mA, VDD = 4.5V, -40°C to +85°C
D090A			VDD-0.7	-	-	V	IOH = -2.5 mA, VDD = 4.5V, -40°C to +125°C
D092	OSC2/CLKOUT (RC osc config)		VDD-0.7	-	-	V	IOH = -1.3 mA, VDD = 4.5V, -40°C to +85°C
D092A			VDD-0.7	-	-	V	IOH = -1.0 mA, VDD = 4.5V, -40°C to +125°C
D150*	Open-Drain High Voltage	VOD	-	-	14	V	RA4 pin
Capacitive Loading Specs on Output Pins							
D100	OSC2 pin	COsc2	-	-	15	pF	In XT, HS and LP modes when external clock is used to drive OSC1.
D101	All I/O pins and OSC2 (in RC mode)	CIO	-	-	50	pF	
D102	SCL, SDA in I ² C mode	Cb	-	-	400	pF	

* These parameters are characterized but not tested.

† Data in "Typ" column is at 5V, 25°C unless otherwise stated. These parameters are for design guidance only and are not tested.

- Note 1: In RC oscillator configuration, the OSC1/CLKIN pin is a Schmitt Trigger input. It is not recommended that the PIC16C6X be driven with external clock in RC mode.
- 2: The leakage current on the MCLR/VPP pin is strongly dependent on the applied voltage level. The specified levels represent normal operating conditions. Higher leakage current may be measured at different input voltages.
- 3: Negative current is defined as current sourced by the pin.

PIC16C6X

Applicable Devices 61 62 62A R62 63 R63 64 64A R64 65 65A R65 66 67

20.4 Timing Parameter Symbology

The timing parameter symbols have been created following one of the following formats:

1. TppS2ppS
2. TppS
3. TCC:ST (I²C specifications only)
4. Ts (I²C specifications only)

T			
F	Frequency	T	Time

Lowercase letters (pp) and their meanings:

pp			
cc	CCP1	osc	OSC1
ck	CLKOUT	rd	\overline{RD}
cs	\overline{CS}	rw	\overline{RD} or \overline{WR}
di	SDI	sc	SCK
do	SDO	ss	\overline{SS}
dt	Data in	t0	T0CKI
io	I/O port	t1	T1CKI
mc	\overline{MCLR}	wr	\overline{WR}

Uppercase letters and their meanings:

S			
F	Fall	P	Period
H	High	R	Rise
I	Invalid (Hi-impedance)	V	Valid
L	Low	Z	Hi-impedance
I²C only			
AA	output access	High	High
BUF	Bus free	Low	Low

TCC:ST (I²C specifications only)

CC			
HD	Hold	SU	Setup
ST			
DAT	DATA input hold	STO	STOP condition
STA	START condition		

FIGURE 20-1: LOAD CONDITIONS FOR DEVICE TIMING SPECIFICATIONS



20.5 Timing Diagrams and Specifications

FIGURE 20-2: EXTERNAL CLOCK TIMING



TABLE 20-2: EXTERNAL CLOCK TIMING REQUIREMENTS

Param No.	Sym	Characteristic	Min	Typ†	Max	Units	Conditions
	Fosc	External CLKIN Frequency (Note 1)	DC	—	4	MHz	XT and RC osc mode
			DC	—	4	MHz	HS osc mode (-04)
			DC	—	10	MHz	HS osc mode (-10)
			DC	—	20	MHz	HS osc mode (-20)
			DC	—	200	kHz	LP osc mode
		Oscillator Frequency (Note 1)	DC	—	4	MHz	RC osc mode
			0.1	—	4	MHz	XT osc mode
			4	—	20	MHz	HS osc mode
			5	—	200	kHz	LP osc mode
1	Tosc	External CLKIN Period (Note 1)	250	—	—	ns	XT and RC osc mode
			250	—	—	ns	HS osc mode (-04)
			100	—	—	ns	HS osc mode (-10)
			50	—	—	ns	HS osc mode (-20)
			5	—	—	µs	LP osc mode
		Oscillator Period (Note 1)	250	—	—	ns	RC osc mode
			250	—	10,000	ns	XT osc mode
			250	—	250	ns	HS osc mode (-04)
			100	—	250	ns	HS osc mode (-10)
			50	—	250	ns	HS osc mode (-20)
			5	—	—	µs	LP osc mode
2	TcY	Instruction Cycle Time (Note 1)	200	TcY	DC	ns	TcY = 4/Fosc
3*	TosL, TosH	External Clock in (OSC1) High or Low Time	100	—	—	ns	XT oscillator
			2.5	—	—	µs	LP oscillator
			15	—	—	ns	HS oscillator
4*	TosR, TosF	External Clock in (OSC1) Rise or Fall Time	—	—	25	ns	XT oscillator
			—	—	50	ns	LP oscillator
			—	—	15	ns	HS oscillator

* These parameters are characterized but not tested.

† Data in "Typ" column is at 5V, 25°C unless otherwise stated. These parameters are for design guidance only and are not tested.

Note 1: Instruction cycle period (TcY) equals four times the input oscillator time-base period. All specified values are based on characterization data for that particular oscillator type under standard operating conditions with the device executing code. Exceeding these specified limits may result in an unstable oscillator operation and/or higher than expected current consumption. All devices are tested to operate at "min." values with an external clock applied to the OSC1/CLKIN pin. When an external clock input is used, the "Max." cycle time limit is "DC" (no clock) for all devices.

PIC16C6X

Applicable Devices 61 62 62A R62 63 R63 64 64A R64 65 65A R65 66 67

FIGURE 20-3: CLKOUT AND I/O TIMING



TABLE 20-3: CLKOUT AND I/O TIMING REQUIREMENTS

Parameter No.	Sym	Characteristic	Min	Typ†	Max	Units	Conditions
10*	TosH2ckL	OSC1↑ to CLKOUT↓	—	75	200	ns	Note 1
11*	TosH2ckH	OSC1↑ to CLKOUT↑	—	75	200	ns	Note 1
12*	TckR	CLKOUT rise time	—	35	100	ns	Note 1
13*	TckF	CLKOUT fall time	—	35	100	ns	Note 1
14*	TckL2ioV	CLKOUT ↓ to Port out valid	—	—	0.5TCY + 20	ns	Note 1
15*	TioV2ckH	Port in valid before CLKOUT ↑	Tosc + 200	—	—	ns	Note 1
16*	TckH2ioI	Port in hold after CLKOUT ↑	0	—	—	ns	Note 1
17*	TosH2ioV	OSC1↑ (Q1 cycle) to Port out valid	—	50	150	ns	
18*	TosH2ioI	OSC1↑ (Q2 cycle) to Port input invalid (I/O in hold time)	PIC16C63/65A	100	—	—	ns
			PIC16LC63/65A	200	—	—	ns
19*	TioV2osH	Port input valid to OSC1↑ (I/O in setup time)	0	—	—	ns	
20*	TioR	Port output rise time	PIC16C63/65A	—	10	40	ns
			PIC16LC63/65A	—	—	80	ns
21*	TioF	Port output fall time	PIC16C63/65A	—	10	40	ns
			PIC16LC63/65A	—	—	80	ns
22††	Tinp	INT pin high or low time	TCY	—	—	ns	
23††	Trbp	RB7:RB4 change INT high or low time	TCY	—	—	ns	

* These parameters are characterized but not tested.

† Data in "Typ" column is at 5V, 25°C unless otherwise stated. These parameters are for design guidance only and are not tested.

†† These parameters are asynchronous events not related to any internal clock edge.

Note 1: Measurements are taken in RC Mode where CLKOUT output is 4 x Tosc.

FIGURE 20-4: RESET, WATCHDOG TIMER, OSCILLATOR START-UP TIMER AND POWER-UP TIMER TIMING



FIGURE 20-5: BROWN-OUT RESET TIMING



TABLE 20-4: RESET, WATCHDOG TIMER, OSCILLATOR START-UP TIMER, POWER-UP TIMER, AND BROWN-OUT RESET REQUIREMENTS

Parameter No.	Sym	Characteristic	Min	Typ†	Max	Units	Conditions
30	Tmcl	MCLR Pulse Width (low)	2	—	—	μs	VDD = 5V, -40°C to +125°C
31*	Twdt	Watchdog Timer Time-out Period (No Prescaler)	7	18	33	ms	VDD = 5V, -40°C to +125°C
32	Tost	Oscillation Start-up Timer Period	—	1024 Tosc	—	—	TOSC = OSC1 period
33*	Tpwrt	Power-up Timer Period	28	72	132	ms	VDD = 5V, -40°C to +125°C
34	Tioz	I/O Hi-impedance from MCLR Low or WDT reset	—	—	2.1	μs	
35	TBOR	Brown-out Reset Pulse Width	100	—	—	μs	VDD ≤ BVDD (D005)

* These parameters are characterized but not tested.

† Data in "Typ" column is at 5V, 25°C unless otherwise stated. These parameters are for design guidance only and are not tested.

PIC16C6X

Applicable Devices 61 62 62A R62 63 R63 64 64A R64 65 65A R65 66 67

FIGURE 20-6: TIMER0 AND TIMER1 EXTERNAL CLOCK TIMINGS



TABLE 20-5: TIMER0 AND TIMER1 EXTERNAL CLOCK REQUIREMENTS

Param No.	Sym	Characteristic		Min	Typ†	Max	Units	Conditions
40*	Tt0H	T0CKI High Pulse Width	No Prescaler	$0.5T_{CY} + 20$	—	—	ns	Must also meet parameter 42
			With Prescaler	10	—	—	ns	
41*	Tt0L	T0CKI Low Pulse Width	No Prescaler	$0.5T_{CY} + 20$	—	—	ns	Must also meet parameter 42
			With Prescaler	10	—	—	ns	
42*	Tt0P	T0CKI Period	No Prescaler	$T_{CY} + 40$	—	—	ns	
			With Prescaler	Greater of: 20 or $T_{CY} + 40$ N	—	—	ns	N = prescale value (2, 4, ..., 256)
45*	Tt1H	T1CKI High Time	Synchronous, Prescaler = 1	$0.5T_{CY} + 20$	—	—	ns	Must also meet parameter 47
			Synchronous, Prescaler = 2, 4, 8	PIC16C6X 15 PIC16LC6X 25	—	—	ns	
			Asynchronous	PIC16C6X 30 PIC16LC6X 50	—	—	ns	
						—	—	
46*	Tt1L	T1CKI Low Time	Synchronous, Prescaler = 1	$0.5T_{CY} + 20$	—	—	ns	Must also meet parameter 47
			Synchronous, Prescaler = 2, 4, 8	PIC16C6X 15 PIC16LC6X 25	—	—	ns	
			Asynchronous	PIC16C6X 30 PIC16LC6X 50	—	—	ns	
						—	—	
47*	Tt1P	T1CKI input period	Synchronous	PIC16C6X Greater of: 30 OR $T_{CY} + 40$ N PIC16LC6X Greater of: 50 OR $T_{CY} + 40$ N	—	—	ns	N = prescale value (1, 2, 4, 8)
			Asynchronous	PIC16C6X 60 PIC16LC6X 100	—	—	ns	
	Ft1	Timer1 oscillator input frequency range (oscillator enabled by setting bit T1OSCEN)		DC	—	200	kHz	
48	TCKEZtmr1	Delay from external clock edge to timer increment		$2T_{osc}$	—	$7T_{osc}$	—	

* These parameters are characterized but not tested.

† Data in "Typ" column is at 5V, 25°C unless otherwise stated. These parameters are for design guidance only and are not tested.

FIGURE 20-7: CAPTURE/COMPARE/PWM TIMINGS (CCP1 AND CCP2)



TABLE 20-6: CAPTURE/COMPARE/PWM REQUIREMENTS (CCP1 AND CCP2)

Parameter No.	Sym	Characteristic	Min	Typ†	Max	Units	Conditions	
50*	TccL	CCP1 and CCP2 input low time	No Prescaler	$0.5T_{CY} + 20$	—	—	ns	
			With Prescaler	PIC16C63/65A	10	—	—	ns
				PIC16LC63/65A	20	—	—	ns
51*	TccH	CCP1 and CCP2 input high time	No Prescaler	$0.5T_{CY} + 20$	—	—	ns	
			With Prescaler	PIC16C63/65A	10	—	—	ns
				PIC16LC63/65A	20	—	—	ns
52*	TccP	CCP1 and CCP2 input period	$\frac{3T_{CY} + 40}{N}$	—	—	ns	N = prescale value (1, 4, or 16)	
53*	TccR	CCP1 and CCP2 output rise time	PIC16C63/65A	—	10	25	ns	
			PIC16LC63/65A	—	25	45	ns	
54*	TccF	CCP1 and CCP2 output fall time	PIC16C63/65A	—	10	25	ns	
			PIC16LC63/65A	—	25	45	ns	

* These parameters are characterized but not tested.

† Data in "Typ" column is at 5V, 25°C unless otherwise stated. These parameters are for design guidance only and are not tested.

PIC16C6X

Applicable Devices 61 62 62A R62 63 R63 64 64A R64 65 65A R65 66 67

FIGURE 20-8: PARALLEL SLAVE PORT TIMING (PIC16C65A)



TABLE 20-7: PARALLEL SLAVE PORT REQUIREMENTS (PIC16C65A)

Parameter No.	Sym	Characteristic	Min	Typ†	Max	Units	Conditions	
62*	TdtV2wrH	Data in valid before $\overline{WR}\uparrow$ or $\overline{CS}\uparrow$ (setup time)	20	—	—	ns	Extended Range Only	
			25	—	—	ns		
63*	TwrH2dtl	$\overline{WR}\uparrow$ or $\overline{CS}\uparrow$ to data-in invalid (hold time)	PIC16C65A	20	—	—	ns	
			PIC16LC65A	35	—	—	ns	
64	TrdL2dtV	$\overline{RD}\downarrow$ and $\overline{CS}\downarrow$ to data-out valid	—	—	80	ns	Extended Range Only	
			—	—	90	ns		
65*	TrdH2dtl	$\overline{RD}\uparrow$ or $\overline{CS}\uparrow$ to data-out invalid	10	—	30	ns		

* These parameters are characterized but not tested.

† Data in "Typ" column is at 5V, 25°C unless otherwise stated. These parameters are for design guidance only and are not tested.

FIGURE 20-9: SPI MODE TIMING



TABLE 20-8: SPI MODE REQUIREMENTS

Parameter No.	Sym	Characteristic	Min	Typ†	Max	Units	Conditions
70*	TssL2scH, TssL2scL	$\overline{SS}\downarrow$ to SCK \downarrow or SCK \uparrow input	T _{CY}	—	—	ns	
71*	Tsch	SCK input high time (slave mode)	T _{CY} + 20	—	—	ns	
72*	TscL	SCK input low time (slave mode)	T _{CY} + 20	—	—	ns	
73*	TdiV2scH, TdiV2scL	Setup time of SDI data input to SCK edge	50	—	—	ns	
74*	Tsch2diL, TscL2diL	Hold time of SDI data input to SCK edge	50	—	—	ns	
75*	TdoR	SDO data output rise time	—	10	25	ns	
76*	TdoF	SDO data output fall time	—	10	25	ns	
77*	TssH2doZ	$\overline{SS}\uparrow$ to SDO output hi-impedance	10	—	50	ns	
78*	TscR	SCK output rise time (master mode)	—	10	25	ns	
79*	TscF	SCK output fall time (master mode)	—	10	25	ns	
80*	Tsch2doV, TscL2doV	SDO data output valid after SCK edge	—	—	50	ns	

* These parameters are characterized but not tested.

† Data in "Typ" column is at 5V, 25°C unless otherwise stated. These parameters are for design guidance only and are not tested.

PIC16C6X

Applicable Devices 61 62 62A R62 63 R63 64 64A R64 65 65A R65 66 67

FIGURE 20-10: I²C BUS START/STOP BITS TIMING



TABLE 20-9: I²C BUS START/STOP BITS REQUIREMENTS

Parameter No.	Sym	Characteristic	Min	Typ	Max	Units	Conditions	
90*	TSU:STA	START condition Setup time	100 kHz mode	4700	—	—	ns	Only relevant for repeated START condition
			400 kHz mode	600	—	—		
91*	THD:STA	START condition Hold time	100 kHz mode	4000	—	—	ns	After this period the first clock pulse is generated
			400 kHz mode	600	—	—		
92*	TSU:STO	STOP condition Setup time	100 kHz mode	4700	—	—	ns	
			400 kHz mode	600	—	—		
93	THD:STO	STOP condition Hold time	100 kHz mode	4000	—	—	ns	
			400 kHz mode	600	—	—		

* These parameters are characterized but not tested.

FIGURE 20-11: I²C BUS DATA TIMING



TABLE 20-10: I²C BUS DATA REQUIREMENTS

Parameter No.	Sym	Characteristic	Min	Max	Units	Conditions	
100*	THIGH	Clock high time	100 kHz mode	4.0	—	μs	Device must operate at a minimum of 1.5 MHz
			400 kHz mode	0.6	—	μs	Device must operate at a minimum of 10 MHz
			SSP Module	1.5T _{CY}	—		
101*	TLOW	Clock low time	100 kHz mode	4.7	—	μs	Device must operate at a minimum of 1.5 MHz
			400 kHz mode	1.3	—	μs	Device must operate at a minimum of 10 MHz
			SSP Module	1.5T _{CY}	—		
102*	TR	SDA and SCL rise time	100 kHz mode	—	1000	ns	
			400 kHz mode	20 + 0.1C _b	300	ns	C _b is specified to be from 10-400 pF
103*	TF	SDA and SCL fall time	100 kHz mode	—	300	ns	
			400 kHz mode	20 + 0.1C _b	300	ns	C _b is specified to be from 10-400 pF
90*	TSU:STA	START condition setup time	100 kHz mode	4.7	—	μs	Only relevant for repeated START condition
			400 kHz mode	0.6	—	μs	
91*	THD:STA	START condition hold time	100 kHz mode	4.0	—	μs	After this period the first clock pulse is generated
			400 kHz mode	0.6	—	μs	
106*	THD:DAT	Data input hold time	100 kHz mode	0	—	ns	
			400 kHz mode	0	0.9	μs	
107*	TSU:DAT	Data input setup time	100 kHz mode	250	—	ns	Note 2
			400 kHz mode	100	—	ns	
92*	TSU:STO	STOP condition setup time	100 kHz mode	4.7	—	μs	
			400 kHz mode	0.6	—	μs	
109*	TAA	Output valid from clock	100 kHz mode	—	3500	ns	Note 1
			400 kHz mode	—	—	ns	
110*	TBUF	Bus free time	100 kHz mode	4.7	—	μs	Time the bus must be free before a new transmission can start
			400 kHz mode	1.3	—	μs	
	C _b	Bus capacitive loading	—	400	pF		

* These parameters are characterized but not tested.

Note 1: As a transmitter, the device must provide this internal minimum delay time to bridge the undefined region (min. 300 ns) of the falling edge of SCL to avoid unintended generation of START or STOP conditions.

2: A fast-mode (400 kHz) I²C-bus device can be used in a standard-mode (100 kHz) I²C-bus system, but the requirement TSU:DAT ≥ 250 ns must then be met. This will automatically be the case if the device does not stretch the LOW period of the SCL signal. If such a device does stretch the LOW period of the SCL signal, it must output the next data bit to the SDA line TR max.+tsu:DAT = 1000 + 250 = 1250 ns (according to the standard-mode I²C bus specification) before the SCL line is released.

PIC16C6X

Applicable Devices 61 62 62A R62 63 R63 64 64A R64 65 65A R65 66 67

FIGURE 20-12: USART SYNCHRONOUS TRANSMISSION (MASTER/SLAVE) TIMING



TABLE 20-11: USART SYNCHRONOUS TRANSMISSION REQUIREMENTS

Parameter No.	Sym	Characteristic	Min	Typ†	Max	Units	Conditions	
120*	TckH2dtV	SYNC XMIT (MASTER & SLAVE)						
		Clock high to data out valid	PIC16C63/65A	—	—	80	ns	
121*	Tckrf	Clock out rise time and fall time (Master Mode)	PIC16C63/65A	—	—	45	ns	
			PIC16LC63/65A	—	—	50	ns	
122*	Tdtrf	Data out rise time and fall time	PIC16C63/65A	—	—	45	ns	
			PIC16LC63/65A	—	—	50	ns	

* These parameters are characterized but not tested.

†: Data in "Typ" column is at 5V, 25°C unless otherwise stated. These parameters are for design guidance only and are not tested.

FIGURE 20-13: USART SYNCHRONOUS RECEIVE (MASTER/SLAVE) TIMING

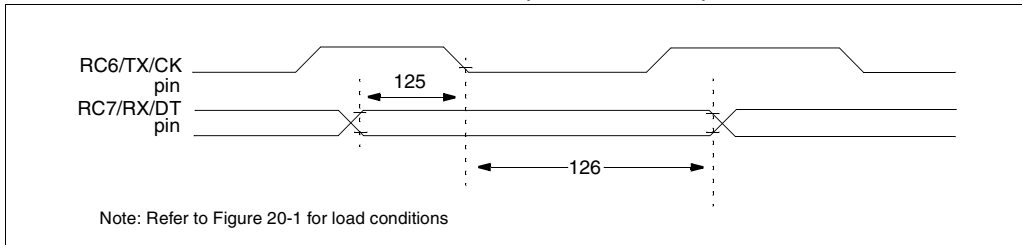

TABLE 20-12: USART SYNCHRONOUS RECEIVE REQUIREMENTS

Parameter No.	Sym	Characteristic	Min	Typ†	Max	Units	Conditions
125*	TdtV2ckL	SYNC RCV (MASTER & SLAVE)					
		Data setup before CK ↓ (DT setup time)	15	—	—	ns	
126*	TckL2dtl	Data hold after CK ↓ (DT hold time)	15	—	—	ns	

* These parameters are characterized but not tested.

†: Data in "Typ" column is at 5V, 25°C unless otherwise stated. These parameters are for design guidance only and are not tested.

21.0 ELECTRICAL CHARACTERISTICS FOR PIC16CR63/R65

Absolute Maximum Ratings (†)

Ambient temperature under bias.....	-55°C to +125°C
Storage temperature	-65°C to +150°C
Voltage on any pin with respect to V _{SS} (except V _{DD} , MCLR, and RA4).....	-0.3V to (V _{DD} + 0.3V)
Voltage on V _{DD} with respect to V _{SS}	-0.3V to +7.5V
Voltage on MCLR with respect to V _{SS} (Note 2).....	0V to +14V
Voltage on RA4 with respect to V _{SS}	0V to +14V
Total power dissipation (Note 1).....	1.0W
Maximum current out of V _{SS} pin	300 mA
Maximum current into V _{DD} pin	250 mA
Input clamp current, I _{IK} (V _I < 0 or V _I > V _{DD}).....	±20 mA
Output clamp current, I _{OK} (V _O < 0 or V _O > V _{DD})	±20 mA
Maximum output current sunk by any I/O pin.....	25 mA
Maximum output current sourced by any I/O pin	25 mA
Maximum current sunk by PORTA, PORTB, and PORTE (Note 3) (combined).....	200 mA
Maximum current sourced by PORTA, PORTB, and PORTE (Note 3) (combined).....	200 mA
Maximum current sunk by PORTC and PORTD (Note 3) (combined).....	200 mA
Maximum current sourced by PORTC and PORTD (Note 3) (combined).....	200 mA

Note 1: Power dissipation is calculated as follows: $P_{dis} = V_{DD} \times (I_{DD} - \sum I_{OH}) + \sum (V_{DD} - V_{OH}) \times I_{OH} + \sum (V_{OL} \times I_{OL})$

Note 2: Voltage spikes below V_{SS} at the MCLR/V_{PP} pin, inducing currents greater than 80 mA, may cause latch-up. Thus, a series resistor of 50-100Ω should be used when applying a “low” level to the MCLR/V_{PP} pin rather than pulling this pin directly to V_{SS}.

Note 3: PORTD and PORTE not available on the PIC16CR63.

† NOTICE: Stresses above those listed under “Absolute Maximum Ratings” may cause permanent damage to the device. This is a stress rating only and functional operation of the device at those or any other conditions above those indicated in the operation listings of this specification is not implied. Exposure to maximum rating conditions for extended periods may affect device reliability.

TABLE 21-1: CROSS REFERENCE OF DEVICE SPECS FOR OSCILLATOR CONFIGURATIONS AND FREQUENCIES OF OPERATION (COMMERCIAL DEVICES)

OSC	PIC16CR63-04 PIC16CR65-04	PIC16CR63-10 PIC16CR65-10	PIC16CR63-20 PIC16CR65-20	PIC16LCR63-04 PIC16LCR65-04	JW Devices
RC	V _{DD} : 4.0V to 5.5V I _{DD} : 5 mA max. at 5.5V I _{PD} : 16 μA max. at 4V Freq: 4 MHz max.	V _{DD} : 4.5V to 5.5V I _{DD} : 2.7 mA typ. at 5.5V I _{PD} : 1.5 μA typ. at 4V Freq: 4 MHz max.	V _{DD} : 4.5V to 5.5V I _{DD} : 2.7 mA typ. at 5.5V I _{PD} : 1.5 μA typ. at 4V Freq: 4 MHz max.	V _{DD} : 3.0V to 5.5V I _{DD} : 3.8 mA max. at 3V I _{PD} : 5 μA max. at 3V Freq: 4 MHz max.	V _{DD} : 4.0V to 5.5V I _{DD} : 5 mA max. at 5.5V I _{PD} : 16 μA max. at 4V Freq: 4 MHz max.
XT	V _{DD} : 4.0V to 5.5V I _{DD} : 5 mA max. at 5.5V I _{PD} : 16 μA max. at 4V Freq: 4 MHz max.	V _{DD} : 4.5V to 5.5V I _{DD} : 2.7 mA typ. at 5.5V I _{PD} : 1.5 μA typ. at 4V Freq: 4 MHz max.	V _{DD} : 4.5V to 5.5V I _{DD} : 2.7 mA typ. at 5.5V I _{PD} : 1.5 μA typ. at 4V Freq: 4 MHz max.	V _{DD} : 3.0V to 5.5V I _{DD} : 3.8 mA max. at 3V I _{PD} : 5 μA max. at 3V Freq: 4 MHz max.	V _{DD} : 4.0V to 5.5V I _{DD} : 5 mA max. at 5.5V I _{PD} : 16 μA max. at 4V Freq: 4 MHz max.
HS	V _{DD} : 4.5V to 5.5V I _{DD} : 13.5 mA typ. at 5.5V I _{PD} : 1.5 μA typ. at 4.5V Freq: 4 MHz max.	V _{DD} : 4.5V to 5.5V I _{DD} : 10 mA max. at 5.5V I _{PD} : 1.5 μA typ. at 4.5V Freq: 10 MHz max.	V _{DD} : 4.5V to 5.5V I _{DD} : 20 mA max. at 5.5V I _{PD} : 1.5 μA typ. at 4.5V Freq: 20 MHz max.	Not recommended for use in HS mode	V _{DD} : 4.5V to 5.5V I _{DD} : 20 mA max. at 5.5V I _{PD} : 1.5 μA typ. at 4.5V Freq: 20 MHz max.
LP	V _{DD} : 4.0V to 5.5V I _{DD} : 52.5 μA typ. at 32 kHz, 4.0V I _{PD} : 0.9 μA typ. at 4.0V Freq: 200 kHz max.	Not recommended for use in LP mode	Not recommended for use in LP mode	V _{DD} : 3.0V to 5.5V I _{DD} : 48 μA max. at 32 kHz, 3.0V I _{PD} : 5 μA max. at 3.0V Freq: 200 kHz max.	V _{DD} : 3.0V to 5.5V I _{DD} : 48 μA max. at 32 kHz, 3.0V I _{PD} : 5 μA max. at 3.0V Freq: 200 kHz max.

The shaded sections indicate oscillator selections which are tested for functionality, but not for MIN/MAX specifications. It is recommended that the user select the device type that ensures the specifications required.

PIC16C6X

Applicable Devices 61 62 62A R62 63 R63 64 64A R64 65 65A R65 66 67

21.1 DC Characteristics: PIC16CR63/R65-04 (Commercial, Industrial) PIC16CR63/R65-10 (Commercial, Industrial) PIC16CR63/R65-20 (Commercial, Industrial)

DC CHARACTERISTICS		Standard Operating Conditions (unless otherwise stated) Operating temperature $-40^{\circ}\text{C} \leq T_A \leq +85^{\circ}\text{C}$ for industrial and $0^{\circ}\text{C} \leq T_A \leq +70^{\circ}\text{C}$ for commercial					
Param No.	Characteristic	Sym	Min	Typ†	Max	Units	Conditions
D001 D001A	Supply Voltage	VDD	4.0 4.5	-	5.5 5.5	V V	XT, RC and LP osc configuration HS osc configuration
D002*	RAM Data Retention Voltage (Note 1)	VDR	-	1.5	-	V	
D003	VDD start voltage to ensure internal Power-on Reset signal	VPOR	-	VSS	-	V	See section on Power-on Reset for details
D004*	VDD rise rate to ensure internal Power-on Reset signal	SVDD	0.05	-	-	V/ms	See section on Power-on Reset for details
D005	Brown-out Reset Voltage	BVDD	3.7	4.0	4.3	V	BODEN configuration bit is enabled
D010	Supply Current (Note 2, 5)	IDD	-	2.7	5	mA	XT, RC, osc config FOSC = 4 MHz, VDD = 5.5V (Note 4)
D013			-	10	20	mA	HS osc config FOSC = 20 MHz, VDD = 5.5V
D015*	Brown-out Reset Current (Note 6)	Δ IBOR	-	350	425	μA	BOR enabled, VDD = 5.0V
D020 D021 D021A	Power-down Current (Note 3, 5)	IPD	-	10.5 1.5 1.5	42 16 19	μA μA μA	VDD = 4.0V, WDT enabled, -40°C to $+85^{\circ}\text{C}$ VDD = 4.0V, WDT disabled, -0°C to $+70^{\circ}\text{C}$ VDD = 4.0V, WDT disabled, -40°C to $+85^{\circ}\text{C}$
D023*	Brown-out Reset Current (Note 6)	Δ IBOR	-	350	425	μA	BOR enabled, VDD = 5.0V

* These parameters are characterized but not tested.

† Data in "Typ" column is at 5V, 25°C unless otherwise stated. These parameters are for design guidance only and are not tested.

Note 1: This is the limit to which VDD can be lowered without losing RAM data.

2: The supply current is mainly a function of the operating voltage and frequency. Other factors such as I/O pin loading and switching rate, oscillator type, internal code execution pattern, and temperature also have an impact on the current consumption.

The test conditions for all IDD measurements in active operation mode are:

OSC1 = external square wave, from rail to rail; all I/O pins tristated, pulled to VDD,

MCLR = VDD; WDT enabled/disabled as specified.

3: The power down current in SLEEP mode does not depend on the oscillator type. Power-down current is measured with the part in SLEEP mode, with all I/O pins in hi-impedance state and tied to VDD and VSS.

4: For RC osc configuration, current through Rext is not included. The current through the resistor can be estimated by the formula $I_r = V_{DD}/2R_{ext}$ (mA) with Rext in kOhm.

5: Timer1 oscillator (when enabled) adds approximately 20 μA to the specification. This value is from characterization and is for design guidance only. This is not tested.

6: The Δ current is the additional current consumed when this peripheral is enabled. This current should be added to the base IDD or IPD measurement.

21.2 DC Characteristics: PIC16LCR63/R65-04 (Commercial, Industrial)

DC CHARACTERISTICS		Standard Operating Conditions (unless otherwise stated)						Conditions
Param No.	Characteristic	Sym	Min	Typ†	Max	Units		
Operating temperature $-40^{\circ}\text{C} \leq T_A \leq +85^{\circ}\text{C}$ for industrial and $0^{\circ}\text{C} \leq T_A \leq +70^{\circ}\text{C}$ for commercial								
D001	Supply Voltage	VDD	3.0	-	5.5	V	LP, XT, RC osc configuration (DC - 4 MHz)	
D002*	RAM Data Retention Voltage (Note 1)	VDR	-	1.5	-	V		
D003	VDD start voltage to ensure internal Power-on Reset signal	VPOR	-	VSS	-	V	See section on Power-on Reset for details	
D004*	VDD rise rate to ensure internal Power-on Reset signal	SVDD	0.05	-	-	V/ms	See section on Power-on Reset for details	
D005	Brown-out Reset Voltage	BVDD	3.7	4.0	4.3	V	BODEN configuration bit is enabled	
D010	Supply Current (Note 2, 5)	IDD	-	2.0	3.8	mA	XT, RC osc configuration FOSC = 4 MHz, VDD = 3.0V (Note 4)	
D010A				22.5	48	μA	LP osc configuration FOSC = 32 kHz, VDD = 3.0V, WDT disabled	
D015*	Brown-out Reset Current (Note 6)	ΔIBOR	-	350	425	μA	BOR enabled, VDD = 5.0V	
D020	Power-down Current (Note 3, 5)	IPD	-	7.5	30	μA	VDD = 3.0V, WDT enabled, -40°C to $+85^{\circ}\text{C}$	
D021				0.9	5	μA	VDD = 3.0V, WDT disabled, 0°C to $+70^{\circ}\text{C}$	
D021A				0.9	5	μA	VDD = 3.0V, WDT disabled, -40°C to $+85^{\circ}\text{C}$	
D023*	Brown-out Reset Current (Note 6)	ΔIBOR	-	350	425	μA	BOR enabled, VDD = 5.0V	

* These parameters are characterized but not tested.

† Data in "Typ" column is at 5V, 25°C unless otherwise stated. These parameters are for design guidance only and are not tested.

Note 1: This is the limit to which VDD can be lowered without losing RAM data.

2: The supply current is mainly a function of the operating voltage and frequency. Other factors such as I/O pin loading and switching rate, oscillator type, internal code execution pattern, and temperature also have an impact on the current consumption.

The test conditions for all IDD measurements in active operation mode are:

OSC1 = external square wave, from rail to rail; all I/O pins tristated, pulled to VDD,

MCLR = VDD; WDT enabled/disabled as specified.

3: The power-down current in SLEEP mode does not depend on the oscillator type. Power-down current is measured with the part in SLEEP mode, with all I/O pins in hi-impedance state and tied to VDD and VSS.

4: For RC osc configuration, current through Rext is not included. The current through the resistor can be estimated by the formula $I_r = V_{DD}/2R_{ext}$ (mA) with Rext in kOhm.

5: Timer1 oscillator (when enabled) adds approximately 20 μA to the specification. This value is from characterization and is for design guidance only. This is not tested.

6: The Δ current is the additional current consumed when this peripheral is enabled. This current should be added to the base IDD or IPD measurement.

PIC16C6X

Applicable Devices 61 62 62A R62 63 R63 64 64A R64 65 65A R65 66 67

21.3 DC Characteristics: **PIC16CR63/R65-04 (Commercial, Industrial)**
PIC16CR63/R65-10 (Commercial, Industrial)
PIC16CR63/R65-20 (Commercial, Industrial)
PIC16LCR63/R65-04 (Commercial, Industrial)

DC CHARACTERISTICS		Standard Operating Conditions (unless otherwise stated)					
		Operating temperature $-40^{\circ}\text{C} \leq T_A \leq +85^{\circ}\text{C}$ for industrial and $0^{\circ}\text{C} \leq T_A \leq +70^{\circ}\text{C}$ for commercial Operating voltage V_{DD} range as described in DC spec Section 21.1 and Section 21.2					
Param No.	Characteristic	Sym	Min	Typ †	Max	Units	Conditions
D030 D030A D031 D032 D033	Input Low Voltage I/O ports with TTL buffer with Schmitt Trigger buffer MCLR, OSC1 (in RC mode) OSC1 (in XT, HS and LP)	VIL	VSS VSS VSS VSS VSS	- - - - -	0.15VDD 0.8V 0.2VDD 0.2VDD 0.3VDD	V V V V V	For entire VDD range $4.5\text{V} \leq V_{DD} \leq 5.5\text{V}$ Note1
D040 D040A D041 D042 D042A D043	Input High Voltage I/O ports with TTL buffer with Schmitt Trigger buffer MCLR OSC1 (XT, HS and LP) OSC1 (in RC mode)	VIH	2.0 0.25VDD + 0.8V 0.8VDD 0.8VDD 0.7VDD 0.9VDD	- - - - - - -	VDD VDD VDD VDD VDD VDD VDD	V V V V V V V	$4.5\text{V} \leq V_{DD} \leq 5.5\text{V}$ For entire VDD range For entire VDD range Note1
D070	PORTB weak pull-up current	IPURB	50	250	400	μA	$V_{DD} = 5\text{V}$, $V_{PIN} = V_{SS}$
D060 D061 D063	Input Leakage Current (Notes 2, 3) I/O ports MCLR, RA4/T0CKI OSC1	IIL	- - -	- - -	±1 ±5 ±5	μA μA μA	$V_{SS} \leq V_{PIN} \leq V_{DD}$, Pin at hi-impedance $V_{SS} \leq V_{PIN} \leq V_{DD}$ $V_{SS} \leq V_{PIN} \leq V_{DD}$, XT, HS and LP osc configuration
D080 D083	Output Low Voltage I/O ports OSC2/CLKOUT (RC osc config)	VOL	- -	- -	0.6 0.6	V V	$I_{OL} = 8.5\text{ mA}$, $V_{DD} = 4.5\text{V}$, -40°C to $+85^{\circ}\text{C}$ $I_{OL} = 1.6\text{ mA}$, $V_{DD} = 4.5\text{V}$, -40°C to $+85^{\circ}\text{C}$
D090 D092	Output High Voltage I/O ports (Note 3) OSC2/CLKOUT (RC osc config)	VOH	$V_{DD}-0.7$ $V_{DD}-0.7$	- -	- -	V V	$I_{OH} = -3.0\text{ mA}$, $V_{DD} = 4.5\text{V}$, -40°C to $+85^{\circ}\text{C}$ $I_{OH} = -1.3\text{ mA}$, $V_{DD} = 4.5\text{V}$, -40°C to $+85^{\circ}\text{C}$
D150*	Open-Drain High Voltage	VOD	-	-	14	V	RA4 pin

* These parameters are characterized but not tested.

† Data in "Typ" column is at 5V, 25°C unless otherwise stated. These parameters are for design guidance only and are not tested.

Note 1: In RC oscillator configuration, the OSC1/CLKIN pin is a Schmitt Trigger input. It is not recommended that the PIC16C6X be driven with external clock in RC mode.

2: The leakage current on the MCLR/VPP pin is strongly dependent on the applied voltage level. The specified levels represent normal operating conditions. Higher leakage current may be measured at different input voltages.

3: Negative current is defined as current sourced by the pin.

PIC16C6X

Applicable Devices 61 62 62A R62 63 R63 64 64A R64 65 65A R65 66 67

DC CHARACTERISTICS		Standard Operating Conditions (unless otherwise stated)						Conditions
		Operating temperature -40°C ≤ TA ≤ +85°C for industrial and 0°C ≤ TA ≤ +70°C for commercial						
		Operating voltage VDD range as described in DC spec Section 21.1 and Section 21.2						
Param No.	Characteristic	Sym	Min	Typ †	Max	Units		
Capacitive Loading Specs on Output Pins								
D100	OSC2 pin	Cosc2	-	-	15	pF	In XT, HS and LP modes when external clock is used to drive OSC1.	
D101	All I/O pins and OSC2 (in RC mode)	CiO	-	-	50	pF		
D102	SCL, SDA in I ² C mode	Cb	-	-	400	pF		

* These parameters are characterized but not tested.

† Data in "Typ" column is at 5V, 25°C unless otherwise stated. These parameters are for design guidance only and are not tested.

Note 1: In RC oscillator configuration, the OSC1/CLKIN pin is a Schmitt Trigger input. It is not recommended that the PIC16C6X be driven with external clock in RC mode.

2: The leakage current on the $\overline{\text{MCLR}}/\text{VPP}$ pin is strongly dependent on the applied voltage level. The specified levels represent normal operating conditions. Higher leakage current may be measured at different input voltages.

3: Negative current is defined as current sourced by the pin.

PIC16C6X

Applicable Devices 61 62 62A R62 63 R63 64 64A R64 65 65A R65 66 67

21.4 Timing Parameter Symbology

The timing parameter symbols have been created following one of the following formats:

1. TppS2ppS
2. TppS
3. TCC:ST (I²C specifications only)
4. Ts (I²C specifications only)

T			
F	Frequency	T	Time

Lowercase letters (pp) and their meanings:

pp			
cc	CCP1	osc	OSC1
ck	CLKOUT	rd	\overline{RD}
cs	\overline{CS}	rw	\overline{RD} or \overline{WR}
di	SDI	sc	SCK
do	SDO	ss	\overline{SS}
dt	Data in	t0	T0CKI
io	I/O port	t1	T1CKI
mc	\overline{MCLR}	wr	\overline{WR}

Uppercase letters and their meanings:

S			
F	Fall	P	Period
H	High	R	Rise
I	Invalid (Hi-impedance)	V	Valid
L	Low	Z	Hi-impedance
I²C only			
AA	output access	High	High
BUF	Bus free	Low	Low

TCC:ST (I²C specifications only)

CC			
HD	Hold	SU	Setup
ST			
DAT	DATA input hold	STO	STOP condition
STA	START condition		

FIGURE 21-1: LOAD CONDITIONS FOR DEVICE TIMING SPECIFICATIONS



21.5 Timing Diagrams and Specifications

FIGURE 21-2: EXTERNAL CLOCK TIMING



TABLE 21-2: EXTERNAL CLOCK TIMING REQUIREMENTS

Param No.	Sym	Characteristic	Min	Typ†	Max	Units	Conditions
	Fosc	External CLKIN Frequency (Note 1)	DC	—	4	MHz	XT and RC osc mode
			DC	—	4	MHz	HS osc mode (-04)
			DC	—	10	MHz	HS osc mode (-10)
			DC	—	20	MHz	HS osc mode (-20)
			DC	—	200	kHz	LP osc mode
		Oscillator Frequency (Note 1)	DC	—	4	MHz	RC osc mode
			0.1	—	4	MHz	XT osc mode
			4	—	20	MHz	HS osc mode
			5	—	200	kHz	LP osc mode
1	Tosc	External CLKIN Period (Note 1)	250	—	—	ns	XT and RC osc mode
			250	—	—	ns	HS osc mode (-04)
			100	—	—	ns	HS osc mode (-10)
			50	—	—	ns	HS osc mode (-20)
			5	—	—	µs	LP osc mode
		Oscillator Period (Note 1)	250	—	—	ns	RC osc mode
			250	—	10,000	ns	XT osc mode
			250	—	250	ns	HS osc mode (-04)
			100	—	250	ns	HS osc mode (-10)
			50	—	250	ns	HS osc mode (-20)
			5	—	—	µs	LP osc mode
2	Tcy	Instruction Cycle Time (Note 1)	200	Tcy	DC	ns	Tcy = 4/Fosc
3*	TosL, TosH	External Clock in (OSC1) High or Low Time	100	—	—	ns	XT oscillator
			2.5	—	—	µs	LP oscillator
			15	—	—	ns	HS oscillator
4*	TosR, TosF	External Clock in (OSC1) Rise or Fall Time	—	—	25	ns	XT oscillator
			—	—	50	ns	LP oscillator
			—	—	15	ns	HS oscillator

* These parameters are characterized but not tested.

† Data in "Typ" column is at 5V, 25°C unless otherwise stated. These parameters are for design guidance only and are not tested.

Note 1: Instruction cycle period (Tcy) equals four times the input oscillator time-base period. All specified values are based on characterization data for that particular oscillator type under standard operating conditions with the device executing code. Exceeding these specified limits may result in an unstable oscillator operation and/or higher than expected current consumption. All devices are tested to operate at "min." values with an external clock applied to the OSC1/CLKIN pin. When an external clock input is used, the "Max." cycle time limit is "DC" (no clock) for all devices.

PIC16C6X

Applicable Devices 61 62 62A R62 63 R63 64 64A R64 65 65A R65 66 67

FIGURE 21-3: CLKOUT AND I/O TIMING



TABLE 21-3: CLKOUT AND I/O TIMING REQUIREMENTS

Param No.	Sym	Characteristic	Min	Typ†	Max	Units	Conditions
10*	TosH2ckL	OSC1↑ to CLKOUT↓	—	75	200	ns	Note 1
11*	TosH2ckH	OSC1↑ to CLKOUT↑	—	75	200	ns	Note 1
12*	TckR	CLKOUT rise time	—	35	100	ns	Note 1
13*	TckF	CLKOUT fall time	—	35	100	ns	Note 1
14*	TckL2ioV	CLKOUT ↓ to Port out valid	—	—	0.5TCY + 20	ns	Note 1
15*	TioV2ckH	Port in valid before CLKOUT ↑	Tosc + 200	—	—	ns	Note 1
16*	TckH2ioI	Port in hold after CLKOUT ↑	0	—	—	ns	Note 1
17*	TosH2ioV	OSC1↑ (Q1 cycle) to Port out valid	—	50	150	ns	
18*	TosH2ioI	OSC1↑ (Q2 cycle) to Port input invalid (I/O in hold time)	PIC16CR63/R65 100 PIC16LCR63/R65 200	—	—	ns	
19*	TioV2osH	Port input valid to OSC1↑ (I/O in setup time)	0	—	—	ns	
20*	TioR	Port output rise time	PIC16CR63/R65 — PIC16LCR63/R65 —	10 —	40 80	ns	
21*	TioF	Port output fall time	PIC16CR63/R65 — PIC16LCR63/R65 —	10 —	40 80	ns	
22††*	Tinp	INT pin high or low time	TCY	—	—	ns	
23††*	Trbp	RB7:RB4 change INT high or low time	TCY	—	—	ns	

* These parameters are characterized but not tested.

† Data in "Typ" column is at 5V, 25°C unless otherwise stated. These parameters are for design guidance only and are not tested.

†† These parameters are asynchronous events not related to any internal clock edge.

Note 1: Measurements are taken in RC Mode where CLKOUT output is 4 x Tosc.

FIGURE 21-4: RESET, WATCHDOG TIMER, OSCILLATOR START-UP TIMER AND POWER-UP TIMER TIMING



FIGURE 21-5: BROWN-OUT RESET TIMING



TABLE 21-4: RESET, WATCHDOG TIMER, OSCILLATOR START-UP TIMER, POWER-UP TIMER, AND BROWN-OUT RESET REQUIREMENTS

Parameter No.	Sym	Characteristic	Min	Typ†	Max	Units	Conditions
30	Tmcl	MCLR Pulse Width (low)	2	—	—	μs	VDD = 5V, -40°C to +125°C
31*	Twdt	Watchdog Timer Time-out Period (No Prescaler)	7	18	33	ms	VDD = 5V, -40°C to +125°C
32	Tost	Oscillation Start-up Timer Period	—	1024 TOSC	—	—	TOSC = OSC1 period
33*	Tpwrt	Power-up Timer Period	28	72	132	ms	VDD = 5V, -40°C to +125°C
34	Tioz	I/O Hi-impedance from MCLR Low or WDT reset	—	—	2.1	μs	
35	TBOR	Brown-out Reset Pulse Width	100	—	—	μs	VDD ≤ BVDD (D005)

* These parameters are characterized but not tested.

† Data in "Typ" column is at 5V, 25°C unless otherwise stated. These parameters are for design guidance only and are not tested.

PIC16C6X

Applicable Devices 61 62 62A R62 63 R63 64 64A R64 65 65A R65 66 67

FIGURE 21-6: TIMER0 AND TIMER1 EXTERNAL CLOCK TIMINGS



TABLE 21-5: TIMER0 AND TIMER1 EXTERNAL CLOCK REQUIREMENTS

Param No.	Sym	Characteristic		Min	Typ†	Max	Units	Conditions
40*	Tt0H	T0CKI High Pulse Width	No Prescaler	$0.5T_{CY} + 20$	—	—	ns	Must also meet parameter 42
			With Prescaler	10	—	—	ns	
41*	Tt0L	T0CKI Low Pulse Width	No Prescaler	$0.5T_{CY} + 20$	—	—	ns	Must also meet parameter 42
			With Prescaler	10	—	—	ns	
42*	Tt0P	T0CKI Period	No Prescaler	$T_{CY} + 40$	—	—	ns	N = prescale value (2, 4, ..., 256)
			With Prescaler	Greater of: 20 or $T_{CY} + 40$ N	—	—	ns	
45*	Tt1H	T1CKI High Time	Synchronous, Prescaler = 1	$0.5T_{CY} + 20$	—	—	ns	Must also meet parameter 47
			Synchronous, Prescaler = 2,4,8	PIC16C6X 15 PIC16LC6X 25	—	—	ns	
			Asynchronous	PIC16C6X 30 PIC16LC6X 50	—	—	ns	
					—	—	ns	
46*	Tt1L	T1CKI Low Time	Synchronous, Prescaler = 1	$0.5T_{CY} + 20$	—	—	ns	Must also meet parameter 47
			Synchronous, Prescaler = 2,4,8	PIC16C6X 15 PIC16LC6X 25	—	—	ns	
			Asynchronous	PIC16C6X 30 PIC16LC6X 50	—	—	ns	
					—	—	ns	
47*	Tt1P	T1CKI input period	Synchronous	PIC16C6X Greater of: 30 OR $T_{CY} + 40$ N PIC16LC6X Greater of: 50 OR $T_{CY} + 40$ N	—	—	ns	N = prescale value (1, 2, 4, 8)
			Asynchronous	PIC16C6X 60 PIC16LC6X 100	—	—	ns	N = prescale value (1, 2, 4, 8)
	Ft1	Timer1 oscillator input frequency range (oscillator enabled by setting bit T1OSCEN)		DC	—	200	kHz	
48	TCKEZtmr1	Delay from external clock edge to timer increment		$2T_{osc}$	—	$7T_{osc}$	—	

* These parameters are characterized but not tested.

† Data in "Typ" column is at 5V, 25°C unless otherwise stated. These parameters are for design guidance only and are not tested.

FIGURE 21-7: CAPTURE/COMPARE/PWM TIMINGS (CCP1 AND CCP2)



TABLE 21-6: CAPTURE/COMPARE/PWM REQUIREMENTS (CCP1 AND CCP2)

Param No.	Sym	Characteristic		Min	Typ†	Max	Units	Conditions	
50*	TccL	CCP1 and CCP2 input low time	No Prescaler	$0.5T_{CY} + 20$	—	—	ns		
			With Prescaler	PIC16CR63/R65	10	—	—		ns
				PIC16LCR63/R65	20	—	—		ns
51*	TccH	CCP1 and CCP2 input high time	No Prescaler	$0.5T_{CY} + 20$	—	—	ns		
			With Prescaler	PIC16CR63/R65	10	—	—		ns
				PIC16LCR63/R65	20	—	—		ns
52*	TccP	CCP1 and CCP2 input period		$\frac{3T_{CY} + 40}{N}$	—	—	ns	N = prescale value (1, 4, or 16)	
53*	TccR	CCP1 and CCP2 output rise time		PIC16CR63/R65	—	10	25	ns	
				PIC16LCR63/R65	—	25	45	ns	
54*	TccF	CCP1 and CCP2 output fall time		PIC16CR63/R65	—	10	25	ns	
				PIC16LCR63/R65	—	25	45	ns	

* These parameters are characterized but not tested.

† Data in "Typ" column is at 5V, 25°C unless otherwise stated. These parameters are for design guidance only and are not tested.

PIC16C6X

Applicable Devices 61 62 62A R62 63 R63 64 64A R64 65 65A R65 66 67

FIGURE 21-8: PARALLEL SLAVE PORT TIMING (PIC16CR65)



TABLE 21-7: PARALLEL SLAVE PORT REQUIREMENTS (PIC16CR65)

Parameter No.	Sym	Characteristic	Min	Typ†	Max	Units	Conditions	
62*	TdtV2wrH	Data in valid before $\overline{WR}\uparrow$ or $\overline{CS}\uparrow$ (setup time)	20	—	—	ns		
63*	TwrH2dtI	$\overline{WR}\uparrow$ or $\overline{CS}\uparrow$ to data-in invalid (hold time)	PIC16CR65	20	—	—	ns	
			PIC16LCR65	35	—	—	ns	
64	TrdL2dtV	$\overline{RD}\downarrow$ and $\overline{CS}\downarrow$ to data-out valid	—	—	80	ns		
65*	TrdH2dtI	$\overline{RD}\uparrow$ or $\overline{CS}\uparrow$ to data-out invalid	10	—	30	ns		

* These parameters are characterized but not tested.

† Data in "Typ" column is at 5V, 25°C unless otherwise stated. These parameters are for design guidance only and are not tested.

FIGURE 21-9: SPI MODE TIMING



TABLE 21-8: SPI MODE REQUIREMENTS

Parameter No.	Sym	Characteristic	Min	Typ†	Max	Units	Conditions
70*	Tssl2scH, Tssl2scL	$\overline{SS}\downarrow$ to SCK \downarrow or SCK \uparrow input	T _{CV}	—	—	ns	
71*	TscH	SCK input high time (slave mode)	T _{CV} + 20	—	—	ns	
72*	TscL	SCK input low time (slave mode)	T _{CV} + 20	—	—	ns	
73*	TdiV2scH, TdiV2scL	Setup time of SDI data input to SCK edge	50	—	—	ns	
74*	Tsch2diL, TscL2diL	Hold time of SDI data input to SCK edge	50	—	—	ns	
75*	TdoR	SDO data output rise time	—	10	25	ns	
76*	TdoF	SDO data output fall time	—	10	25	ns	
77*	TssH2doZ	$\overline{SS}\uparrow$ to SDO output hi-impedance	10	—	50	ns	
78*	TscR	SCK output rise time (master mode)	—	10	25	ns	
79*	TscF	SCK output fall time (master mode)	—	10	25	ns	
80*	Tsch2doV, TscL2doV	SDO data output valid after SCK edge	—	—	50	ns	

* These parameters are characterized but not tested.

† Data in "Typ" column is at 5V, 25°C unless otherwise stated. These parameters are for design guidance only and are not tested.

PIC16C6X

Applicable Devices 61 62 62A R62 63 R63 64 64A R64 65 65A R65 66 67

FIGURE 21-10: I²C BUS START/STOP BITS TIMING



TABLE 21-9: I²C BUS START/STOP BITS REQUIREMENTS

Parameter No.	Sym	Characteristic	Min	Typ	Max	Units	Conditions	
90*	TSU:STA	START condition Setup time	100 kHz mode	4700	—	—	ns	Only relevant for repeated START condition
			400 kHz mode	600	—	—		
91*	THD:STA	START condition Hold time	100 kHz mode	4000	—	—	ns	After this period the first clock pulse is generated
			400 kHz mode	600	—	—		
92*	TSU:STO	STOP condition Setup time	100 kHz mode	4700	—	—	ns	
			400 kHz mode	600	—	—		
93	THD:STO	STOP condition Hold time	100 kHz mode	4000	—	—	ns	
			400 kHz mode	600	—	—		

* These parameters are characterized but not tested.

FIGURE 21-11: I²C BUS DATA TIMING



TABLE 21-10: I²C BUS DATA REQUIREMENTS

Parameter No.	Sym	Characteristic	Min	Max	Units	Conditions	
100*	THIGH	Clock high time	100 kHz mode	4.0	—	μs	Device must operate at a minimum of 1.5 MHz
			400 kHz mode	0.6	—	μs	Device must operate at a minimum of 10 MHz
			SSP Module	1.5T _{CY}	—		
101*	TLOW	Clock low time	100 kHz mode	4.7	—	μs	Device must operate at a minimum of 1.5 MHz
			400 kHz mode	1.3	—	μs	Device must operate at a minimum of 10 MHz
			SSP Module	1.5T _{CY}	—		
102*	TR	SDA and SCL rise time	100 kHz mode	—	1000	ns	
			400 kHz mode	20 + 0.1C _b	300	ns	C _b is specified to be from 10-400 pF
103*	TF	SDA and SCL fall time	100 kHz mode	—	300	ns	
			400 kHz mode	20 + 0.1C _b	300	ns	C _b is specified to be from 10-400 pF
90*	TSU:STA	START condition setup time	100 kHz mode	4.7	—	μs	Only relevant for repeated START condition
			400 kHz mode	0.6	—	μs	
91*	THD:STA	START condition hold time	100 kHz mode	4.0	—	μs	After this period the first clock pulse is generated
			400 kHz mode	0.6	—	μs	
106*	THD:DAT	Data input hold time	100 kHz mode	0	—	ns	
			400 kHz mode	0	0.9	μs	
107*	TSU:DAT	Data input setup time	100 kHz mode	250	—	ns	Note 2
			400 kHz mode	100	—	ns	
92*	TSU:STO	STOP condition setup time	100 kHz mode	4.7	—	μs	
			400 kHz mode	0.6	—	μs	
109*	TAA	Output valid from clock	100 kHz mode	—	3500	ns	Note 1
			400 kHz mode	—	—	ns	
110*	TBUF	Bus free time	100 kHz mode	4.7	—	μs	Time the bus must be free before a new transmission can start
			400 kHz mode	1.3	—	μs	
	C _b	Bus capacitive loading	—	400	pF		

* These parameters are characterized but not tested.

Note 1: As a transmitter, the device must provide this internal minimum delay time to bridge the undefined region (min. 300 ns) of the falling edge of SCL to avoid unintended generation of START or STOP conditions.

2: A fast-mode (400 kHz) I²C-bus device can be used in a standard-mode (100 kHz) I²C-bus system, but the requirement T_{SU:DAT} ≥ 250 ns must then be met. This will automatically be the case if the device does not stretch the LOW period of the SCL signal. If such a device does stretch the LOW period of the SCL signal, it must output the next data bit to the SDA line T_R max. + t_{SU:DAT} = 1000 + 250 = 1250 ns (according to the standard-mode I²C bus specification) before the SCL line is released.

PIC16C6X

Applicable Devices 61 62 62A R62 63 R63 64 64A R64 65 65A R65 66 67

FIGURE 21-12: USART SYNCHRONOUS TRANSMISSION (MASTER/SLAVE) TIMING



TABLE 21-11: USART SYNCHRONOUS TRANSMISSION REQUIREMENTS

Param No.	Sym	Characteristic	Min	Typ†	Max	Units	Conditions
120*	TckH2dtV	SYNC XMIT (MASTER & SLAVE)	—	—	80	ns	
		Clock high to data out valid	—	—	100	ns	
121*	Tckrf	Clock out rise time and fall time (Master Mode)	—	—	45	ns	
			—	—	50	ns	
122*	Tdtrf	Data out rise time and fall time	—	—	45	ns	
			—	—	50	ns	

* These parameters are characterized but not tested.

†: Data in "Typ" column is at 5V, 25°C unless otherwise stated. These parameters are for design guidance only and are not tested.

FIGURE 21-13: USART SYNCHRONOUS RECEIVE (MASTER/SLAVE) TIMING

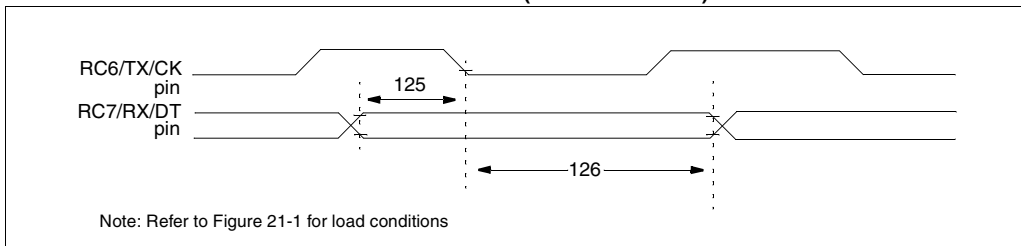

TABLE 21-12: USART SYNCHRONOUS RECEIVE REQUIREMENTS

Parameter No.	Sym	Characteristic	Min	Typ†	Max	Units	Conditions
125*	TdtV2ckL	SYNC RCV (MASTER & SLAVE)					
		Data setup before CK ↓ (DT setup time)	15	—	—	ns	
126*	TckL2dtl	Data hold after CK ↓ (DT hold time)	15	—	—	ns	

* These parameters are characterized but not tested.

†: Data in "Typ" column is at 5V, 25°C unless otherwise stated. These parameters are for design guidance only and are not tested.

22.0 ELECTRICAL CHARACTERISTICS FOR PIC16C66/67

Absolute Maximum Ratings (†)

Ambient temperature under bias.....	-55°C to +125°C
Storage temperature	-65°C to +150°C
Voltage on any pin with respect to V _{SS} (except V _{DD} , MCLR, and RA4).....	-0.3V to (V _{DD} + 0.3V)
Voltage on V _{DD} with respect to V _{SS}	-0.3V to +7.5V
Voltage on MCLR with respect to V _{SS} (Note 2).....	0V to +14V
Voltage on RA4 with respect to V _{SS}	0V to +14V
Total power dissipation (Note 1).....	1.0W
Maximum current out of V _{SS} pin	300 mA
Maximum current into V _{DD} pin	250 mA
Input clamp current, I _{IK} (V _I < 0 or V _I > V _{DD}).....	±20 mA
Output clamp current, I _{OK} (V _O < 0 or V _O > V _{DD})	±20 mA
Maximum output current sunk by any I/O pin.....	25 mA
Maximum output current sourced by any I/O pin	25 mA
Maximum current sunk by PORTA, PORTB, and PORTE (Note 3) (combined).....	200 mA
Maximum current sourced by PORTA, PORTB, and PORTE (Note 3) (combined)	200 mA
Maximum current sunk by PORTC and PORTD (Note 3) (combined)	200 mA
Maximum current sourced by PORTC and PORTD (Note 3) (combined)	200 mA

Note 1: Power dissipation is calculated as follows: $P_{dis} = V_{DD} \times \{I_{DD} - \sum I_{OH}\} + \sum \{(V_{DD} - V_{OH}) \times I_{OH}\} + \sum (V_{OL} \times I_{OL})$

Note 2: Voltage spikes below V_{SS} at the MCLR/VPP pin, inducing currents greater than 80 mA, may cause latch-up. Thus, a series resistor of 50-100Ω should be used when applying a “low” level to the MCLR/VPP pin rather than pulling this pin directly to V_{SS}.

Note 3: PORTD and PORTE not available on the PIC16C66.

† NOTICE: Stresses above those listed under “Absolute Maximum Ratings” may cause permanent damage to the device. This is a stress rating only and functional operation of the device at those or any other conditions above those indicated in the operation listings of this specification is not implied. Exposure to maximum rating conditions for extended periods may affect device reliability.

TABLE 22-1: CROSS REFERENCE OF DEVICE SPECS FOR OSCILLATOR CONFIGURATIONS AND FREQUENCIES OF OPERATION (COMMERCIAL DEVICES)

OSC	PIC16C66-04 PIC16C67-04	PIC16C66-10 PIC16C67-10	PIC16C66-20 PIC16C67-20	PIC16C66-04 PIC16C67-04	JW Devices
RC	V _{DD} : 4.0V to 6.0V I _{DD} : 5 mA max. at 5.5V I _{PD} : 16 μA max. at 4V Freq: 4 MHz max.	V _{DD} : 4.5V to 5.5V I _{DD} : 2.7 mA typ. at 5.5V I _{PD} : 1.5 μA typ. at 4V Freq: 4 MHz max.	V _{DD} : 4.5V to 5.5V I _{DD} : 2.7 mA typ. at 5.5V I _{PD} : 1.5 μA typ. at 4V Freq: 4 MHz max.	V _{DD} : 2.5V to 6.0V I _{DD} : 3.8 mA max. at 3V I _{PD} : 5 μA max. at 3V Freq: 4 MHz max.	V _{DD} : 4.0V to 6.0V I _{DD} : 5 mA max. at 5.5V I _{PD} : 16 μA max. at 4V Freq: 4 MHz max.
XT	V _{DD} : 4.0V to 6.0V I _{DD} : 5 mA max. at 5.5V I _{PD} : 16 μA max. at 4V Freq: 4 MHz max.	V _{DD} : 4.5V to 5.5V I _{DD} : 2.7 mA typ. at 5.5V I _{PD} : 1.5 μA typ. at 4V Freq: 4 MHz max.	V _{DD} : 4.5V to 5.5V I _{DD} : 2.7 mA typ. at 5.5V I _{PD} : 1.5 μA typ. at 4V Freq: 4 MHz max.	V _{DD} : 2.5V to 6.0V I _{DD} : 3.8 mA max. at 3V I _{PD} : 5 μA max. at 3V Freq: 4 MHz max.	V _{DD} : 4.0V to 6.0V I _{DD} : 5 mA max. at 5.5V I _{PD} : 16 μA max. at 4V Freq: 4 MHz max.
HS	V _{DD} : 4.5V to 5.5V I _{DD} : 13.5 mA typ. at 5.5V I _{PD} : 1.5 μA typ. at 4.5V Freq: 4 MHz max.	V _{DD} : 4.5V to 5.5V I _{DD} : 10 mA max. at 5.5V I _{PD} : 1.5 μA typ. at 4.5V Freq: 10 MHz max.	V _{DD} : 4.5V to 5.5V I _{DD} : 20 mA max. at 5.5V I _{PD} : 1.5 μA typ. at 4.5V Freq: 20 MHz max.	Not recommended for use in HS mode	V _{DD} : 4.5V to 5.5V I _{DD} : 20 mA max. at 5.5V I _{PD} : 1.5 μA typ. at 4.5V Freq: 20 MHz max.
LP	V _{DD} : 4.0V to 6.0V I _{DD} : 52.5 μA typ. at 32 kHz, 4.0V I _{PD} : 0.9 μA typ. at 4.0V Freq: 200 kHz max.	Not recommended for use in LP mode	Not recommended for use in LP mode	V _{DD} : 2.5V to 6.0V I _{DD} : 48 μA max. at 32 kHz, 3.0V I _{PD} : 5 μA max. at 3.0V Freq: 200 kHz max.	V _{DD} : 2.5V to 6.0V I _{DD} : 48 μA max. at 32 kHz, 3.0V I _{PD} : 5 μA max. at 3.0V Freq: 200 kHz max.

The shaded sections indicate oscillator selections which are tested for functionality, but not for MIN/MAX specifications. It is recommended that the user select the device type that ensures the specifications required.

PIC16C6X

Applicable Devices 61 62 62A R62 63 R63 64 64A R64 65 65A R65 66 67

22.1 DC Characteristics: PIC16C66/67-04 (Commercial, Industrial, Extended) PIC16C66/67-10 (Commercial, Industrial, Extended) PIC16C66/67-20 (Commercial, Industrial, Extended)

DC CHARACTERISTICS		Standard Operating Conditions (unless otherwise stated)						
		Operating temperature						
		-40°C ≤ TA ≤ +125°C for extended,						
		-40°C ≤ TA ≤ +85°C for industrial and						
		0°C ≤ TA ≤ +70°C for commercial						
Param No.	Characteristic	Sym	Min	Typ†	Max	Units	Conditions	
D001 D001A	Supply Voltage	VDD	4.0 4.5	- -	6.0 5.5	V V	XT, RC and LP osc configuration HS osc configuration	
D002*	RAM Data Retention Voltage (Note 1)	VDR	-	1.5	-	V		
D003	VDD start voltage to ensure internal Power-on Reset signal	VPOR	-	VSS	-	V	See section on Power-on Reset for details	
D004*	VDD rise rate to ensure internal Power-on Reset signal	SVDD	0.05	-	-	V/ms	See section on Power-on Reset for details	
D005	Brown-out Reset Voltage	BVDD	3.7 3.7	4.0 4.0	4.3 4.4	V V	BODEN configuration bit is enabled Extended Range Only	
D010 D013	Supply Current (Note 2, 5)	IDD	- -	2.7 10	5 20	mA mA	XT, RC, osc config FOSC = 4 MHz, VDD = 5.5V (Note 4) HS osc config FOSC = 20 MHz, VDD = 5.5V	
D015*	Brown-out Reset Current (Note 6)	ΔIBOR	-	350	425	μA	BOR enabled, VDD = 5.0V	
D020 D021 D021A D021B	Power-down Current (Note 3, 5)	IPD	- - - -	10.5 1.5 1.5 2.5	42 16 19 19	μA μA μA μA	VDD = 4.0V, WDT enabled, -40°C to +85°C VDD = 4.0V, WDT disabled, -0°C to +70°C VDD = 4.0V, WDT disabled, -40°C to +85°C VDD = 4.0V, WDT disabled, -40°C to +125°C	
D023*	Brown-out Reset Current (Note 6)	ΔIBOR	-	350	425	μA	BOR enabled, VDD = 5.0V	

* These parameters are characterized but not tested.

† Data in "Typ" column is at 5V, 25°C unless otherwise stated. These parameters are for design guidance only and are not tested.

Note 1: This is the limit to which VDD can be lowered without losing RAM data.

2: The supply current is mainly a function of the operating voltage and frequency. Other factors such as I/O pin loading and switching rate, oscillator type, internal code execution pattern, and temperature also have an impact on the current consumption.

The test conditions for all IDD measurements in active operation mode are:

OSC1 = external square wave, from rail to rail; all I/O pins tristated, pulled to VDD,

MCLR = VDD; WDT enabled/disabled as specified.

3: The power down current in SLEEP mode does not depend on the oscillator type. Power-down current is measured with the part in SLEEP mode, with all I/O pins in hi-impedance state and tied to VDD and VSS.

4: For RC osc configuration, current through Rext is not included. The current through the resistor can be estimated by the formula $I_r = V_{DD}/2R_{ext}$ (mA) with Rext in kOhm.

5: Timer1 oscillator (when enabled) adds approximately 20 μA to the specification. This value is from characterization and is for design guidance only. This is not tested.

6: The Δ current is the additional current consumed when this peripheral is enabled. This current should be added to the base IDD or IPD measurement.

22.2 DC Characteristics: PIC16LC66/67-04 (Commercial, Industrial)

DC CHARACTERISTICS		Standard Operating Conditions (unless otherwise stated)						Conditions
Param No.	Characteristic	Sym	Min	Typ†	Max	Units		
Operating temperature $-40^{\circ}\text{C} \leq T_A \leq +85^{\circ}\text{C}$ for industrial and $0^{\circ}\text{C} \leq T_A \leq +70^{\circ}\text{C}$ for commercial								
D001	Supply Voltage	VDD	2.5	-	6.0	V	LP, XT, RC osc configuration (DC - 4 MHz)	
D002*	RAM Data Retention Voltage (Note 1)	VDR	-	1.5	-	V		
D003	VDD start voltage to ensure internal Power-on Reset signal	VPOR	-	VSS	-	V	See section on Power-on Reset for details	
D004*	VDD rise rate to ensure internal Power-on Reset signal	SVDD	0.05	-	-	V/ms	See section on Power-on Reset for details	
D005	Brown-out Reset Voltage	BVDD	3.7	4.0	4.3	V	BODEN configuration bit is enabled	
D010	Supply Current (Note 2, 5)	IDD	-	2.0	3.8	mA	XT, RC osc configuration FOSC = 4 MHz, VDD = 3.0V (Note 4)	
D010A				22.5	48	μA	LP osc configuration FOSC = 32 kHz, VDD = 3.0V, WDT disabled	
D015*	Brown-out Reset Current (Note 6)	ΔIBOR	-	350	425	μA	BOR enabled, VDD = 5.0V	
D020	Power-down Current (Note 3, 5)	IPD	-	7.5	30	μA	VDD = 3.0V, WDT enabled, -40°C to $+85^{\circ}\text{C}$	
D021				0.9	5	μA	VDD = 3.0V, WDT disabled, 0°C to $+70^{\circ}\text{C}$	
D021A				0.9	5	μA	VDD = 3.0V, WDT disabled, -40°C to $+85^{\circ}\text{C}$	
D023*	Brown-out Reset Current (Note 6)	ΔIBOR	-	350	425	μA	BOR enabled, VDD = 5.0V	

* These parameters are characterized but not tested.

† Data in "Typ" column is at 5V, 25°C unless otherwise stated. These parameters are for design guidance only and are not tested.

Note 1: This is the limit to which VDD can be lowered without losing RAM data.

2: The supply current is mainly a function of the operating voltage and frequency. Other factors such as I/O pin loading and switching rate, oscillator type, internal code execution pattern, and temperature also have an impact on the current consumption.

The test conditions for all IDD measurements in active operation mode are:

OSC1 = external square wave, from rail to rail; all I/O pins tristated, pulled to VDD,

MCLR = VDD; WDT enabled/disabled as specified.

3: The power-down current in SLEEP mode does not depend on the oscillator type. Power-down current is measured with the part in SLEEP mode, with all I/O pins in hi-impedance state and tied to VDD and VSS.

4: For RC osc configuration, current through Rext is not included. The current through the resistor can be estimated by the formula $I_r = V_{DD}/2R_{ext}$ (mA) with Rext in kOhm.

5: Timer1 oscillator (when enabled) adds approximately 20 μA to the specification. This value is from characterization and is for design guidance only. This is not tested.

6: The Δ current is the additional current consumed when this peripheral is enabled. This current should be added to the base IDD or IPD measurement.

PIC16C6X

Applicable Devices 61 62 62A R62 63 R63 64 64A R64 65 65A R65 66 67

22.3 DC Characteristics: PIC16C66/67-04 (Commercial, Industrial, Extended) PIC16C66/67-10 (Commercial, Industrial, Extended) PIC16C66/67-20 (Commercial, Industrial, Extended) PIC16LC66/67-04 (Commercial, Industrial)

DC CHARACTERISTICS		Standard Operating Conditions (unless otherwise stated) Operating temperature $-40^{\circ}\text{C} \leq T_A \leq +125^{\circ}\text{C}$ for extended, $-40^{\circ}\text{C} \leq T_A \leq +85^{\circ}\text{C}$ for industrial and $0^{\circ}\text{C} \leq T_A \leq +70^{\circ}\text{C}$ for commercial Operating voltage V_{DD} range as described in DC spec Section 22.1 and Section 22.2					
Param No.	Characteristic	Sym	Min	Typ †	Max	Units	Conditions
D030 D030A	Input Low Voltage I/O ports with TTL buffer	V_{IL}	V_{SS}	-	$0.15V_{DD}$	V	For entire V_{DD} range $4.5V \leq V_{DD} \leq 5.5V$ Note 1
D031	with Schmitt Trigger buffer		V_{SS}	-	$0.2V_{DD}$	V	
D032	\overline{MCLR} , OSC1 (in RC mode)		V_{SS}	-	$0.2V_{DD}$	V	
D033	OSC1 (in XT, HS and LP)		V_{SS}	-	$0.3V_{DD}$	V	
D040 D040A	Input High Voltage I/O ports with TTL buffer	V_{IH}	2.0	-	V_{DD}	V	
D041	with Schmitt Trigger buffer		$0.25V_{DD} + 0.8V$	-	V_{DD}	V	For entire V_{DD} range
D042	\overline{MCLR}		$0.8V_{DD}$	-	V_{DD}	V	For entire V_{DD} range Note 1
D042A	OSC1 (XT, HS and LP)		$0.7V_{DD}$	-	V_{DD}	V	
D043	OSC1 (in RC mode)		$0.9V_{DD}$	-	V_{DD}	V	
D070	PORTB weak pull-up current	I_{PURB}	50	250	400	μA	$V_{DD} = 5V$, $V_{PIN} = V_{SS}$
D060	Input Leakage Current (Notes 2, 3) I/O ports	I_{IL}	-	-	± 1	μA	$V_{SS} \leq V_{PIN} \leq V_{DD}$, Pin at hi-impedance $V_{SS} \leq V_{PIN} \leq V_{DD}$ $V_{SS} \leq V_{PIN} \leq V_{DD}$, XT, HS and LP osc configuration
D061	\overline{MCLR} , RA4/T0CKI		-	-	± 5	μA	
D063	OSC1		-	-	± 5	μA	
D080 D080A	Output Low Voltage I/O ports	V_{OL}	-	-	0.6	V	$I_{OL} = 8.5\text{ mA}$, $V_{DD} = 4.5V$, -40°C to $+85^{\circ}\text{C}$ $I_{OL} = 7.0\text{ mA}$, $V_{DD} = 4.5V$, -40°C to $+125^{\circ}\text{C}$ $I_{OL} = 1.6\text{ mA}$, $V_{DD} = 4.5V$, -40°C to $+85^{\circ}\text{C}$ $I_{OL} = 1.2\text{ mA}$, $V_{DD} = 4.5V$, -40°C to $+125^{\circ}\text{C}$
D083	OSC2/CLKOUT (RC osc config)		-	-	0.6	V	
D083A			-	-	0.6	V	
			-	-	0.6	V	

* These parameters are characterized but not tested.

† Data in "Typ" column is at 5V, 25°C unless otherwise stated. These parameters are for design guidance only and are not tested.

Note 1: In RC oscillator configuration, the OSC1/CLKIN pin is a Schmitt Trigger input. It is not recommended that the PIC16C6X be driven with external clock in RC mode.

2: The leakage current on the \overline{MCLR}/V_{PP} pin is strongly dependent on the applied voltage level. The specified levels represent normal operating conditions. Higher leakage current may be measured at different input voltages.

3: Negative current is defined as current sourced by the pin.

DC CHARACTERISTICS							
Standard Operating Conditions (unless otherwise stated)							
Operating temperature -40°C ≤ TA ≤ +125°C for extended, -40°C ≤ TA ≤ +85°C for industrial and 0°C ≤ TA ≤ +70°C for commercial							
Operating voltage VDD range as described in DC spec Section 22.1 and Section 22.2							
Param No.	Characteristic	Sym	Min	Typ †	Max	Units	Conditions
Output High Voltage							
D090	I/O ports (Note 3)	VOH	VDD-0.7	-	-	V	IOH = -3.0 mA, VDD = 4.5V, -40°C to +85°C
D090A			VDD-0.7	-	-	V	IOH = -2.5 mA, VDD = 4.5V, -40°C to +125°C
D092	OSC2/CLKOUT (RC osc config)		VDD-0.7	-	-	V	IOH = -1.3 mA, VDD = 4.5V, -40°C to +85°C
D092A			VDD-0.7	-	-	V	IOH = -1.0 mA, VDD = 4.5V, -40°C to +125°C
D150*	Open-Drain High Voltage	VOD	-	-	14	V	RA4 pin
Capacitive Loading Specs on Output Pins							
D100	OSC2 pin	Cosc2	-	-	15	pF	In XT, HS and LP modes when external clock is used to drive OSC1.
D101	All I/O pins and OSC2 (in RC mode)	CIO	-	-	50	pF	
D102	SCL, SDA in I ² C mode	Cb	-	-	400	pF	

* These parameters are characterized but not tested.

† Data in "Typ" column is at 5V, 25°C unless otherwise stated. These parameters are for design guidance only and are not tested.

- Note 1: In RC oscillator configuration, the OSC1/CLKIN pin is a Schmitt Trigger input. It is not recommended that the PIC16C6X be driven with external clock in RC mode.
- 2: The leakage current on the MCLR/VPP pin is strongly dependent on the applied voltage level. The specified levels represent normal operating conditions. Higher leakage current may be measured at different input voltages.
- 3: Negative current is defined as current sourced by the pin.

PIC16C6X

Applicable Devices 61 62 62A R62 63 R63 64 64A R64 65 65A R65 66 67

22.4 Timing Parameter Symbology

The timing parameter symbols have been created following one of the following formats:

1. TppS2ppS
2. TppS
3. TCC:ST (I²C specifications only)
4. Ts (I²C specifications only)

T			
F	Frequency	T	Time

Lowercase letters (pp) and their meanings:

pp			
cc	CCP1	osc	OSC1
ck	CLKOUT	rd	\overline{RD}
cs	\overline{CS}	rw	\overline{RD} or \overline{WR}
di	SDI	sc	SCK
do	SDO	ss	\overline{SS}
dt	Data in	t0	T0CKI
io	I/O port	t1	T1CKI
mc	\overline{MCLR}	wr	\overline{WR}

Uppercase letters and their meanings:

S			
F	Fall	P	Period
H	High	R	Rise
I	Invalid (Hi-impedance)	V	Valid
L	Low	Z	Hi-impedance
I²C only			
AA	output access	High	High
BUF	Bus free	Low	Low

TCC:ST (I²C specifications only)

CC			
HD	Hold	SU	Setup
ST			
DAT	DATA input hold	STO	STOP condition
STA	START condition		

FIGURE 22-1: LOAD CONDITIONS FOR DEVICE TIMING SPECIFICATIONS



22.5 Timing Diagrams and Specifications

FIGURE 22-2: EXTERNAL CLOCK TIMING



TABLE 22-2: EXTERNAL CLOCK TIMING REQUIREMENTS

Param No.	Sym	Characteristic	Min	Typ†	Max	Units	Conditions
	Fosc	External CLKIN Frequency (Note 1)	DC	—	4	MHz	XT and RC osc mode
			DC	—	4	MHz	HS osc mode (-04)
			DC	—	10	MHz	HS osc mode (-10)
			DC	—	20	MHz	HS osc mode (-20)
			DC	—	200	kHz	LP osc mode
		Oscillator Frequency (Note 1)	DC	—	4	MHz	RC osc mode
			0.1	—	4	MHz	XT osc mode
			4	—	20	MHz	HS osc mode
			5	—	200	kHz	LP osc mode
1	Tosc	External CLKIN Period (Note 1)	250	—	—	ns	XT and RC osc mode
			250	—	—	ns	HS osc mode (-04)
			100	—	—	ns	HS osc mode (-10)
			50	—	—	ns	HS osc mode (-20)
			5	—	—	µs	LP osc mode
		Oscillator Period (Note 1)	250	—	—	ns	RC osc mode
			250	—	10,000	ns	XT osc mode
			250	—	250	ns	HS osc mode (-04)
			100	—	250	ns	HS osc mode (-10)
			50	—	250	ns	HS osc mode (-20)
			5	—	—	µs	LP osc mode
2	Tcy	Instruction Cycle Time (Note 1)	200	Tcy	DC	ns	Tcy = 4/Fosc
3*	TosL, TosH	External Clock in (OSC1) High or Low Time	100	—	—	ns	XT oscillator
			2.5	—	—	µs	LP oscillator
			15	—	—	ns	HS oscillator
4*	TosR, TosF	External Clock in (OSC1) Rise or Fall Time	—	—	25	ns	XT oscillator
			—	—	50	ns	LP oscillator
			—	—	15	ns	HS oscillator

* These parameters are characterized but not tested.

† Data in "Typ" column is at 5V, 25°C unless otherwise stated. These parameters are for design guidance only and are not tested.

Note 1: Instruction cycle period (Tcy) equals four times the input oscillator time-base period. All specified values are based on characterization data for that particular oscillator type under standard operating conditions with the device executing code. Exceeding these specified limits may result in an unstable oscillator operation and/or higher than expected current consumption. All devices are tested to operate at "min." values with an external clock applied to the OSC1/CLKIN pin. When an external clock input is used, the "Max." cycle time limit is "DC" (no clock) for all devices.

PIC16C6X

Applicable Devices 61 62 62A R62 63 R63 64 64A R64 65 65A R65 66 67

FIGURE 22-3: CLKOUT AND I/O TIMING



TABLE 22-3: CLKOUT AND I/O TIMING REQUIREMENTS

Parameter No.	Sym	Characteristic	Min	Typ†	Max	Units	Conditions
10*	TosH2ckL	OSC1↑ to CLKOUT↓	—	75	200	ns	Note 1
11*	TosH2ckH	OSC1↑ to CLKOUT↑	—	75	200	ns	Note 1
12*	TckR	CLKOUT rise time	—	35	100	ns	Note 1
13*	TckF	CLKOUT fall time	—	35	100	ns	Note 1
14*	TckL2ioV	CLKOUT ↓ to Port out valid	—	—	0.5TCY + 20	ns	Note 1
15*	TioV2ckH	Port in valid before CLKOUT ↑	Tosc + 200	—	—	ns	Note 1
16*	TckH2ioI	Port in hold after CLKOUT ↑	0	—	—	ns	Note 1
17*	TosH2ioV	OSC1↑ (Q1 cycle) to Port out valid	—	50	150	ns	
18*	TosH2ioI	OSC1↑ (Q2 cycle) to Port input invalid (I/O in hold time)	PIC16C66/67	100	—	—	ns
			PIC16LC66/67	200	—	—	ns
19*	TioV2osH	Port input valid to OSC1↑ (I/O in setup time)	0	—	—	ns	
20*	TioR	Port output rise time	PIC16C66/67	—	10	40	ns
			PIC16LC66/67	—	—	80	ns
21*	TioF	Port output fall time	PIC16C66/67	—	10	40	ns
			PIC16LC66/67	—	—	80	ns
22††	Tinp	INT pin high or low time	TCY	—	—	ns	
23††	Trbp	RB7:RB4 change INT high or low time	TCY	—	—	ns	

* These parameters are characterized but not tested.

† Data in "Typ" column is at 5V, 25°C unless otherwise stated. These parameters are for design guidance only and are not tested.

†† These parameters are asynchronous events not related to any internal clock edge.

Note 1: Measurements are taken in RC Mode where CLKOUT output is 4 x Tosc.

FIGURE 22-4: RESET, WATCHDOG TIMER, OSCILLATOR START-UP TIMER AND POWER-UP TIMER TIMING



FIGURE 22-5: BROWN-OUT RESET TIMING



TABLE 22-4: RESET, WATCHDOG TIMER, OSCILLATOR START-UP TIMER, POWER-UP TIMER, AND BROWN-OUT RESET REQUIREMENTS

Parameter No.	Sym	Characteristic	Min	Typ†	Max	Units	Conditions
30	Tmcl	MCLR Pulse Width (low)	2	—	—	μs	VDD = 5V, -40°C to +125°C
31*	Twdt	Watchdog Timer Time-out Period (No Prescaler)	7	18	33	ms	VDD = 5V, -40°C to +125°C
32	Tost	Oscillation Start-up Timer Period	—	1024 TOSC	—	—	TOSC = OSC1 period
33*	Tpwrt	Power-up Timer Period	28	72	132	ms	VDD = 5V, -40°C to +125°C
34	Tioz	I/O Hi-impedance from MCLR Low or WDT reset	—	—	2.1	μs	
35	TBOR	Brown-out Reset Pulse Width	100	—	—	μs	VDD ≤ BVDD (D005)

* These parameters are characterized but not tested.

† Data in "Typ" column is at 5V, 25°C unless otherwise stated. These parameters are for design guidance only and are not tested.

PIC16C6X

Applicable Devices 61 62 62A R62 63 R63 64 64A R64 65 65A R65 66 67

FIGURE 22-6: TIMER0 AND TIMER1 EXTERNAL CLOCK TIMINGS



TABLE 22-5: TIMER0 AND TIMER1 EXTERNAL CLOCK REQUIREMENTS

Param No.	Sym	Characteristic		Min	Typ†	Max	Units	Conditions	
40*	Tt0H	T0CKI High Pulse Width	No Prescaler	0.5Tcy + 20	—	—	ns	Must also meet parameter 42	
			With Prescaler	10	—	—	ns		
41*	Tt0L	T0CKI Low Pulse Width	No Prescaler	0.5Tcy + 20	—	—	ns	Must also meet parameter 42	
			With Prescaler	10	—	—	ns		
42*	Tt0P	T0CKI Period	No Prescaler	Tcy + 40	—	—	ns	N = prescale value (2, 4, ..., 256)	
			With Prescaler	Greater of: 20 or Tcy + 40 N	—	—	ns		
45*	Tt1H	T1CKI High Time	Synchronous, Prescaler = 1	0.5Tcy + 20	—	—	ns	Must also meet parameter 47	
			Synchronous, Prescaler = 2, 4, 8	PIC16C6X	15	—	—		ns
			Asynchronous	PIC16C6X	30	—	—		ns
			PIC16LC6X	50	—	—	ns		
46*	Tt1L	T1CKI Low Time	Synchronous, Prescaler = 1	0.5Tcy + 20	—	—	ns	Must also meet parameter 47	
			Synchronous, Prescaler = 2, 4, 8	PIC16C6X	15	—	—		ns
			Asynchronous	PIC16C6X	30	—	—		ns
			PIC16LC6X	50	—	—	ns		
47*	Tt1P	T1CKI input period	Synchronous	PIC16C6X	Greater of: 30 OR Tcy + 40 N	—	—	ns	N = prescale value (1, 2, 4, 8)
				PIC16LC6X	Greater of: 50 OR Tcy + 40 N				N = prescale value (1, 2, 4, 8)
			Asynchronous	PIC16C6X	60	—	—	ns	
			PIC16LC6X	100	—	—	ns		
	Ft1	Timer1 oscillator input frequency range (oscillator enabled by setting bit T1OSCEN)		DC	—	200	kHz		
48	TCKEZtmr1	Delay from external clock edge to timer increment		2Tosc	—	7Tosc	—		

* These parameters are characterized but not tested.

† Data in "Typ" column is at 5V, 25°C unless otherwise stated. These parameters are for design guidance only and are not tested.

FIGURE 22-7: CAPTURE/COMPARE/PWM TIMINGS (CCP1 AND CCP2)



TABLE 22-6: CAPTURE/COMPARE/PWM REQUIREMENTS (CCP1 AND CCP2)

Parameter No.	Sym	Characteristic	Min	Typ†	Max	Units	Conditions	
50*	TccL	CCP1 and CCP2 input low time	No Prescaler	$0.5T_{CY} + 20$	—	—	ns	
			With Prescaler	PIC16C66/67	10	—	—	ns
				PIC16LC66/67	20	—	—	ns
51*	TccH	CCP1 and CCP2 input high time	No Prescaler	$0.5T_{CY} + 20$	—	—	ns	
			With Prescaler	PIC16C66/67	10	—	—	ns
				PIC16LC66/67	20	—	—	ns
52*	TccP	CCP1 and CCP2 input period	$\frac{3T_{CY} + 40}{N}$	—	—	ns	N = prescale value (1, 4, or 16)	
53*	TccR	CCP1 and CCP2 output rise time	PIC16C66/67	—	10	25	ns	
			PIC16LC66/67	—	25	45	ns	
54*	TccF	CCP1 and CCP2 output fall time	PIC16C66/67	—	10	25	ns	
			PIC16LC66/67	—	25	45	ns	

* These parameters are characterized but not tested.

† Data in "Typ" column is at 5V, 25°C unless otherwise stated. These parameters are for design guidance only and are not tested.

PIC16C6X

Applicable Devices 61 62 62A R62 63 R63 64 64A R64 65 65A R65 66 67

FIGURE 22-8: PARALLEL SLAVE PORT TIMING (PIC16C67)



TABLE 22-7: PARALLEL SLAVE PORT REQUIREMENTS (PIC16C67)

Parameter No.	Sym	Characteristic	Min	Typ†	Max	Units	Conditions	
62*	TdtV2wrH	Data in valid before $\overline{WR}\uparrow$ or $\overline{CS}\uparrow$ (setup time)	20	—	—	ns	Extended Range Only	
			25	—	—	ns		
63*	TwrH2dtl	$\overline{WR}\uparrow$ or $\overline{CS}\uparrow$ to data-in invalid (hold time)	PIC16C67	20	—	—	ns	
			PIC16LC67	35	—	—	ns	
64	TrdL2dtV	$\overline{RD}\downarrow$ and $\overline{CS}\downarrow$ to data-out valid	—	—	80	ns	Extended Range Only	
			—	—	90	ns		
65*	TrdH2dtl	$\overline{RD}\uparrow$ or $\overline{CS}\uparrow$ to data-out invalid	10	—	30	ns		

* These parameters are characterized but not tested.

† Data in "Typ" column is at 5V, 25°C unless otherwise stated. These parameters are for design guidance only and are not tested.

FIGURE 22-9: SPI MASTER MODE TIMING (CKE = 0)



FIGURE 22-10: SPI MASTER MODE TIMING (CKE = 1)



PIC16C6X

Applicable Devices 61 62 62A R62 63 R63 64 64A R64 65 65A R65 66 67

FIGURE 22-11: SPI SLAVE MODE TIMING (CKE = 0)



FIGURE 22-12: SPI SLAVE MODE TIMING (CKE = 1)



TABLE 22-8: SPI MODE REQUIREMENTS

Parameter No.	Sym	Characteristic	Min	Typ†	Max	Units	Conditions
70*	Tssl2scH, Tssl2scL	$\overline{SS}\downarrow$ to SCK \downarrow or SCK \uparrow input	T _{CY}	—	—	ns	
71*	TschH	SCK input high time (slave mode)	T _{CY} + 20	—	—	ns	
72*	TscL	SCK input low time (slave mode)	T _{CY} + 20	—	—	ns	
73*	TdiV2scH, TdiV2scL	Setup time of SDI data input to SCK edge	100	—	—	ns	
74*	Tsch2diL, TscL2diL	Hold time of SDI data input to SCK edge	100	—	—	ns	
75*	TdoR	SDO data output rise time	—	10	25	ns	
76*	TdoF	SDO data output fall time	—	10	25	ns	
77*	TssH2doZ	$\overline{SS}\uparrow$ to SDO output hi-impedance	10	—	50	ns	
78*	TscR	SCK output rise time (master mode)	—	10	25	ns	
79*	TscF	SCK output fall time (master mode)	—	10	25	ns	
80*	Tsch2doV, TscL2doV	SDO data output valid after SCK edge	—	—	50	ns	
81*	TdoV2scH, TdoV2scL	SDO data output setup to SCK edge	T _{CY}	—	—	ns	
82*	Tssl2doV	SDO data output valid after $\overline{SS}\downarrow$ edge	—	—	50	ns	
83*	Tsch2ssH, TscL2ssH	$\overline{SS}\uparrow$ after SCK edge	1.5T _{CY} + 40	—	—	ns	

* These parameters are characterized but not tested.

† Data in "Typ" column is at 5V, 25°C unless otherwise stated. These parameters are for design guidance only and are not tested.

PIC16C6X

Applicable Devices 61 62 62A R62 63 R63 64 64A R64 65 65A R65 66 67

FIGURE 22-13: I²C BUS START/STOP BITS TIMING

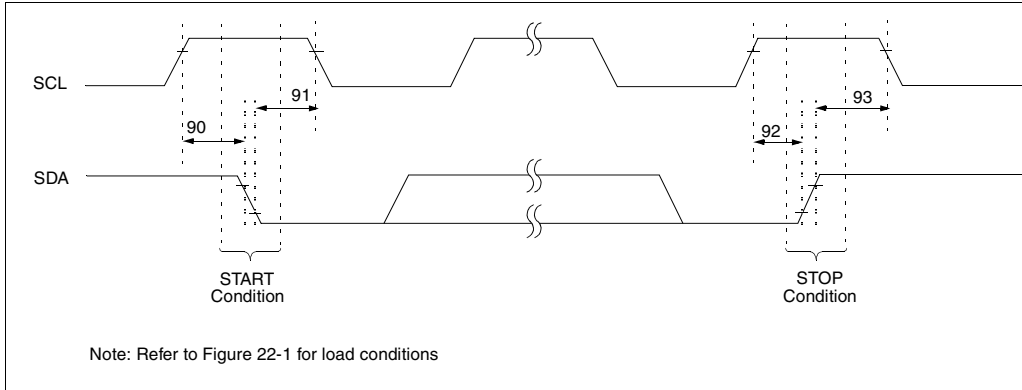

TABLE 22-9: I²C BUS START/STOP BITS REQUIREMENTS

Parameter No.	Sym	Characteristic	Min	Typ	Max	Units	Conditions	
90*	TSU:STA	START condition Setup time	100 kHz mode	4700	—	—	ns	Only relevant for repeated START condition
		400 kHz mode	600	—	—			
91*	THD:STA	START condition Hold time	100 kHz mode	4000	—	—	ns	After this period the first clock pulse is generated
		400 kHz mode	600	—	—			
92*	TSU:STO	STOP condition Setup time	100 kHz mode	4700	—	—	ns	
		400 kHz mode	600	—	—			
93	THD:STO	STOP condition Hold time	100 kHz mode	4000	—	—	ns	
		400 kHz mode	600	—	—			

* These parameters are characterized but not tested.

FIGURE 22-14: I²C BUS DATA TIMING



TABLE 22-10: I²C BUS DATA REQUIREMENTS

Parameter No.	Sym	Characteristic	Min	Max	Units	Conditions	
100*	THIGH	Clock high time	100 kHz mode	4.0	—	μs	Device must operate at a minimum of 1.5 MHz
			400 kHz mode	0.6	—	μs	Device must operate at a minimum of 10 MHz
			SSP Module	1.5T _{CY}	—		
101*	TLOW	Clock low time	100 kHz mode	4.7	—	μs	Device must operate at a minimum of 1.5 MHz
			400 kHz mode	1.3	—	μs	Device must operate at a minimum of 10 MHz
			SSP Module	1.5T _{CY}	—		
102*	TR	SDA and SCL rise time	100 kHz mode	—	1000	ns	
			400 kHz mode	20 + 0.1C _b	300	ns	C _b is specified to be from 10-400 pF
103*	TF	SDA and SCL fall time	100 kHz mode	—	300	ns	
			400 kHz mode	20 + 0.1C _b	300	ns	C _b is specified to be from 10-400 pF
90*	TSU:STA	START condition setup time	100 kHz mode	4.7	—	μs	Only relevant for repeated START condition
			400 kHz mode	0.6	—	μs	
91*	THD:STA	START condition hold time	100 kHz mode	4.0	—	μs	After this period the first clock pulse is generated
			400 kHz mode	0.6	—	μs	
106*	THD:DAT	Data input hold time	100 kHz mode	0	—	ns	
			400 kHz mode	0	0.9	μs	
107*	TSU:DAT	Data input setup time	100 kHz mode	250	—	ns	Note 2
			400 kHz mode	100	—	ns	
92*	TSU:STO	STOP condition setup time	100 kHz mode	4.7	—	μs	
			400 kHz mode	0.6	—	μs	
109*	TAA	Output valid from clock	100 kHz mode	—	3500	ns	Note 1
			400 kHz mode	—	—	ns	
110*	TBUF	Bus free time	100 kHz mode	4.7	—	μs	Time the bus must be free before a new transmission can start
			400 kHz mode	1.3	—	μs	
	C _b	Bus capacitive loading	—	400	pF		

* These parameters are characterized but not tested.

Note 1: As a transmitter, the device must provide this internal minimum delay time to bridge the undefined region (min. 300 ns) of the falling edge of SCL to avoid unintended generation of START or STOP conditions.

2: A fast-mode (400 kHz) I²C-bus device can be used in a standard-mode (100 kHz) I²C-bus system, but the requirement T_{SU:DAT} ≥ 250 ns must then be met. This will automatically be the case if the device does not stretch the LOW period of the SCL signal. If such a device does stretch the LOW period of the SCL signal, it must output the next data bit to the SDA line T_R max. + t_{SU:DAT} = 1000 + 250 = 1250 ns (according to the standard-mode I²C bus specification) before the SCL line is released.

PIC16C6X

Applicable Devices 61 62 62A R62 63 R63 64 64A R64 65 65A R65 66 67

FIGURE 22-15: USART SYNCHRONOUS TRANSMISSION (MASTER/SLAVE) TIMING



TABLE 22-11: USART SYNCHRONOUS TRANSMISSION REQUIREMENTS

Parameter No.	Sym	Characteristic	Min	Typ†	Max	Units	Conditions
120*	TckH2dtV	SYNC XMIT (MASTER & SLAVE)			80	ns	
		Clock high to data out valid			100	ns	
121*	Tckrf	Clock out rise time and fall time (Master Mode)	PIC16C66/67		45	ns	
			PIC16LC66/67		50	ns	
122*	TdtV	Data out rise time and fall time	PIC16C66/67		45	ns	
			PIC16LC66/67		50	ns	

* These parameters are characterized but not tested.

†: Data in "Typ" column is at 5V, 25°C unless otherwise stated. These parameters are for design guidance only and are not tested.

FIGURE 22-16: USART SYNCHRONOUS RECEIVE (MASTER/SLAVE) TIMING



TABLE 22-12: USART SYNCHRONOUS RECEIVE REQUIREMENTS

Parameter No.	Sym	Characteristic	Min	Typ†	Max	Units	Conditions
125*	TdtV2ckL	SYNC RCV (MASTER & SLAVE)					
		Data setup before CK ↓ (DT setup time)	15			ns	
126*	TckL2dtl	Data hold after CK ↓ (DT hold time)	15			ns	

* These parameters are characterized but not tested.

†: Data in "Typ" column is at 5V, 25°C unless otherwise stated. These parameters are for design guidance only and are not tested.

23.0 DC AND AC CHARACTERISTICS GRAPHS AND TABLES FOR: PIC16C62, PIC16C62A, PIC16CR62, PIC16C63, PIC16C64, PIC16C64A, PIC16CR64, PIC16C65A, PIC16C66, PIC16C67

The graphs and tables provided in this section are for design guidance and are not tested or guaranteed.

In some graphs or tables the data presented are outside specified operating range (i.e., outside specified V_{DD} range). This is for information only and devices are guaranteed to operate properly only within the specified range.

Note: The data presented in this section is a statistical summary of data collected on units from different lots over a period of time and matrix samples. 'Typical' represents the mean of the distribution at, 25°C, while 'max' or 'min' represents (mean +3σ) and (mean -3σ) respectively where σ is standard deviation.

FIGURE 23-1: TYPICAL I_{PD} vs. V_{DD} (WDT DISABLED, RC MODE)



FIGURE 23-2: MAXIMUM I_{PD} vs. V_{DD} (WDT DISABLED, RC MODE)



PIC16C6X

Applicable Devices 61 62 62A R62 63 R63 64 64A R64 65 65A R65 66 67

FIGURE 23-3: TYPICAL IPD vs. VDD @ 25°C (WDT ENABLED, RC MODE)



FIGURE 23-4: MAXIMUM IPD vs. VDD (WDT ENABLED, RC MODE)



FIGURE 23-5: TYPICAL RC OSCILLATOR FREQUENCY vs. VDD



FIGURE 23-6: TYPICAL RC OSCILLATOR FREQUENCY vs. VDD



FIGURE 23-7: TYPICAL RC OSCILLATOR FREQUENCY vs. VDD



Data based on matrix samples. See first page of this section for details.

FIGURE 23-8: TYPICAL I_{PD} vs. V_{DD} BROWN-OUT DETECT ENABLED (RC MODE)



FIGURE 23-9: MAXIMUM I_{PD} vs. V_{DD} BROWN-OUT DETECT ENABLED (85°C TO -40°C, RC MODE)



FIGURE 23-10: TYPICAL I_{PD} vs. TIMER1 ENABLED (32 kHz, RC0/RC1 = 33 pF/33 pF, RC MODE)



FIGURE 23-11: MAXIMUM I_{PD} vs. TIMER1 ENABLED (32 kHz, RC0/RC1 = 33 pF/33 pF, 85°C TO -40°C, RC MODE)



Data based on matrix samples. See first page of this section for details.

PIC16C6X

Applicable Devices 61 62 62A R62 63 R63 64 64A R64 65 65A R65 66 67

FIGURE 23-12: TYPICAL I_{DD} vs. FREQUENCY (RC MODE @ 22 pF, 25°C)



FIGURE 23-13: MAXIMUM I_{DD} vs. FREQUENCY (RC MODE @ 22 pF, -40°C TO 85°C)



Data based on matrix samples. See first page of this section for details.

Applicable Devices 61 62 62A R62 63 R63 64 64A R64 65 65A R65 66 67

FIGURE 23-14: TYPICAL I_{DD} vs. FREQUENCY (RC MODE @ 100 pF, 25°C)



FIGURE 23-15: MAXIMUM I_{DD} vs. FREQUENCY (RC MODE @ 100 pF, -40°C TO 85°C)



Data based on matrix samples. See first page of this section for details.

PIC16C6X

Applicable Devices 61 62 62A R62 63 R63 64 64A R64 65 65A R65 66 67

FIGURE 23-16: TYPICAL I_{DD} vs. FREQUENCY (RC MODE @ 300 pF, 25°C)



FIGURE 23-17: MAXIMUM I_{DD} vs. FREQUENCY (RC MODE @ 300 pF, -40°C TO 85°C)



Data based on matrix samples. See first page of this section for details.

FIGURE 23-18: TYPICAL I_{DD} vs. CAPACITANCE @ 500 kHz (RC MODE)



TABLE 23-1: RC OSCILLATOR FREQUENCIES

Cext	Rext	Average Fosc @ 5V, 25°C	
		Fosc (MHz)	Tolerance (%)
22 pF	5k	4.12	± 1.4%
	10k	2.35	± 1.4%
	100k	268	± 1.1%
100 pF	3.3k	1.80	± 1.0%
	5k	1.27	± 1.0%
	10k	688	± 1.2%
	100k	77.2	± 1.0%
300 pF	3.3k	707	± 1.4%
	5k	501	± 1.2%
	10k	269	± 1.6%
	100k	28.3	± 1.1%

The percentage variation indicated here is part to part variation due to normal process distribution. The variation indicated is ±3 standard deviation from average value for V_{DD} = 5V.

FIGURE 23-19: TRANSCONDUCTANCE(g_m) OF HS OSCILLATOR vs. V_{DD}



FIGURE 23-20: TRANSCONDUCTANCE(g_m) OF LP OSCILLATOR vs. V_{DD}



FIGURE 23-21: TRANSCONDUCTANCE(g_m) OF XT OSCILLATOR vs. V_{DD}

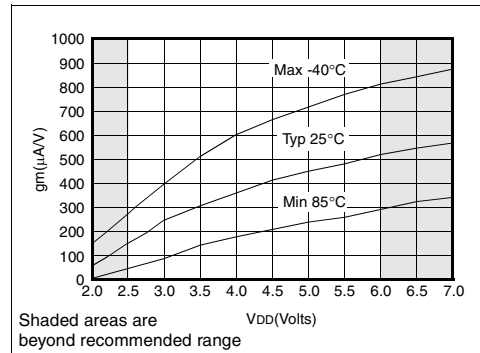

Data based on matrix samples. See first page of this section for details.

PIC16C6X

Applicable Devices 61 62 62A R62 63 R63 64 64A R64 65 65A R65 66 67

FIGURE 23-22: TYPICAL XTAL STARTUP TIME vs. VDD (LP MODE, 25°C)



FIGURE 23-24: TYPICAL XTAL STARTUP TIME vs. VDD (XT MODE, 25°C)



FIGURE 23-23: TYPICAL XTAL STARTUP TIME vs. VDD (HS MODE, 25°C)



TABLE 23-2: CAPACITOR SELECTION FOR CRYSTAL OSCILLATORS

Osc Type	Crystal Freq	Cap. Range C1	Cap. Range C2
LP	32 kHz	33 pF	33 pF
	200 kHz	15 pF	15 pF
XT	200 kHz	47-68 pF	47-68 pF
	1 MHz	15 pF	15 pF
	4 MHz	15 pF	15 pF
HS	4 MHz	15 pF	15 pF
	8 MHz	15-33 pF	15-33 pF
	20 MHz	15-33 pF	15-33 pF
Crystals Used			
32 kHz	Epson C-001R32.768K-A	± 20 PPM	
200 kHz	STD XTL 200.000KHz	± 20 PPM	
1 MHz	ECS ECS-10-13-1	± 50 PPM	
4 MHz	ECS ECS-40-20-1	± 50 PPM	
8 MHz	EPSON CA-301 8.000M-C	± 30 PPM	
20 MHz	EPSON CA-301 20.000M-C	± 30 PPM	

Data based on matrix samples. See first page of this section for details.

**FIGURE 23-25: TYPICAL I_{DD} vs. FREQUENCY
(LP MODE, 25°C)**



**FIGURE 23-26: MAXIMUM I_{DD} vs.
FREQUENCY
(LP MODE, 85°C TO -40°C)**



**FIGURE 23-27: TYPICAL I_{DD} vs. FREQUENCY
(XT MODE, 25°C)**



**FIGURE 23-28: MAXIMUM I_{DD} vs.
FREQUENCY
(XT MODE, -40°C TO 85°C)**



Data based on matrix samples. See first page of this section for details.

PIC16C6X

Applicable Devices [61](#) [62](#) [62A](#) [R62](#) [63](#) [R63](#) [64](#) [64A](#) [R64](#) [65](#) [65A](#) [R65](#) [66](#) [67](#)

**FIGURE 23-29: TYPICAL I_{DD} vs. FREQUENCY
(HS MODE, 25°C)**



**FIGURE 23-30: MAXIMUM I_{DD} vs. FREQUENCY
(HS MODE, -40°C TO 85°C)**



Data based on matrix samples. See first page of this section for details.

24.0 PACKAGING INFORMATION

24.1 18-Lead Plastic Dual In-line (300 mil) (P)

Note: For the most current package drawings, please see the Microchip Packaging Specification located at <http://www.microchip.com/packaging>



Package Group: Plastic Dual In-Line (PLA)						
Symbol	Millimeters			Inches		
	Min	Max	Notes	Min	Max	Notes
α	0°	10°		0°	10°	
A	–	4.064		–	0.160	
A1	0.381	–		0.015	–	
A2	3.048	3.810		0.120	0.150	
B	0.355	0.559		0.014	0.022	
B1	1.524	1.524	Reference	0.060	0.060	Reference
C	0.203	0.381	Typical	0.008	0.015	Typical
D	22.479	23.495		0.885	0.925	
D1	20.320	20.320	Reference	0.800	0.800	Reference
E	7.620	8.255		0.300	0.325	
E1	6.096	7.112		0.240	0.280	
e1	2.489	2.591	Typical	0.098	0.102	Typical
eA	7.620	7.620	Reference	0.300	0.300	Reference
eB	7.874	9.906		0.310	0.390	
L	3.048	3.556		0.120	0.140	
N	18	18		18	18	
S	0.889	–		0.035	–	
S1	0.127	–		0.005	–	

PIC16C6X

24.2 28-Lead Plastic Dual In-line (300 mil) (SP)

Note: For the most current package drawings, please see the Microchip Packaging Specification located at <http://www.microchip.com/packaging>



Package Group: Plastic Dual In-Line (PLA)						
Symbol	Millimeters			Inches		
	Min	Max	Notes	Min	Max	Notes
α	0°	10°		0°	10°	
A	3.632	4.572		0.143	0.180	
A1	0.381	–		0.015	–	
A2	3.175	3.556		0.125	0.140	
B	0.406	0.559		0.016	0.022	
B1	1.016	1.651	Typical	0.040	0.065	Typical
B2	0.762	1.016	4 places	0.030	0.040	4 places
B3	0.203	0.508	4 places	0.008	0.020	4 places
C	0.203	0.331	Typical	0.008	0.013	Typical
D	34.163	35.179		1.385	1.395	
D1	33.020	33.020	Reference	1.300	1.300	Reference
E	7.874	8.382		0.310	0.330	
E1	7.112	7.493		0.280	0.295	
e1	2.540	2.540	Typical	0.100	0.100	Typical
eA	7.874	7.874	Reference	0.310	0.310	Reference
eB	8.128	9.652		0.320	0.380	
L	3.175	3.683		0.125	0.145	
N	28	28		28	28	
S	0.584	1.220		0.023	0.048	

24.3 40-Lead Plastic Dual In-line (600 mil) (P)

Note: For the most current package drawings, please see the Microchip Packaging Specification located at <http://www.microchip.com/packaging>



Package Group: Plastic Dual In-Line (PLA)						
Symbol	Millimeters			Inches		
	Min	Max	Notes	Min	Max	Notes
α	0°	10°		0°	10°	
A	–	5.080		–	0.200	
A1	0.381	–		0.015	–	
A2	3.175	4.064		0.125	0.160	
B	0.355	0.559		0.014	0.022	
B1	1.270	1.778	Typical	0.050	0.070	Typical
C	0.203	0.381	Typical	0.008	0.015	Typical
D	51.181	52.197		2.015	2.055	
D1	48.260	48.260	Reference	1.900	1.900	Reference
E	15.240	15.875		0.600	0.625	
E1	13.462	13.970		0.530	0.550	
e1	2.489	2.591	Typical	0.098	0.102	Typical
eA	15.240	15.240	Reference	0.600	0.600	Reference
eB	15.240	17.272		0.600	0.680	
L	2.921	3.683		0.115	0.145	
N	40	40		40	40	
S	1.270	–		0.050	–	
S1	0.508	–		0.020	–	

PIC16C6X

24.4 18-Lead Plastic Surface Mount (SOIC - Wide, 300 mil Body) (SO)

Note: For the most current package drawings, please see the Microchip Packaging Specification located at <http://www.microchip.com/packaging>



Package Group: Plastic SOIC (SO)						
Symbol	Millimeters			Inches		
	Min	Max	Notes	Min	Max	Notes
α	0°	8°		0°	8°	
A	2.362	2.642		0.093	0.104	
A1	0.101	0.300		0.004	0.012	
B	0.355	0.483		0.014	0.019	
C	0.241	0.318		0.009	0.013	
D	11.353	11.735		0.447	0.462	
E	7.416	7.595		0.292	0.299	
e	1.270	1.270	Reference	0.050	0.050	Reference
H	10.007	10.643		0.394	0.419	
h	0.381	0.762		0.015	0.030	
L	0.406	1.143		0.016	0.045	
N	18	18		18	18	
CP	-	0.102		-	0.004	

24.5 28-Lead Plastic Surface Mount (SOIC - Wide, 300 mil Body) (SO)

Note: For the most current package drawings, please see the Microchip Packaging Specification located at <http://www.microchip.com/packaging>



Package Group: Plastic SOIC (SO)						
Symbol	Millimeters			Inches		
	Min	Max	Notes	Min	Max	Notes
α	0°	8°		0°	8°	
A	2.362	2.642		0.093	0.104	
A1	0.101	0.300		0.004	0.012	
B	0.355	0.483		0.014	0.019	
C	0.241	0.318		0.009	0.013	
D	17.703	18.085		0.697	0.712	
E	7.416	7.595		0.292	0.299	
e	1.270	1.270	Typical	0.050	0.050	Typical
H	10.007	10.643		0.394	0.419	
h	0.381	0.762		0.015	0.030	
L	0.406	1.143		0.016	0.045	
N	28	28		28	28	
CP	–	0.102		–	0.004	

PIC16C6X

24.6 18-Lead Ceramic Cerdip Dual In-line with Window (300 mil) (JW)

Note: For the most current package drawings, please see the Microchip Packaging Specification located at <http://www.microchip.com/packaging>



Package Group: Ceramic Cerdip Dual In-Line (CDP)

Symbol	Millimeters			Inches		
	Min	Max	Notes	Min	Max	Notes
α	0°	10°		0°	10°	
A	—	5.080		—	0.200	
A1	0.381	1.778		0.015	0.070	
A2	3.810	4.699		0.150	0.185	
A3	3.810	4.445		0.150	0.175	
B	0.355	0.585		0.014	0.023	
B1	1.270	1.651	Typical	0.050	0.065	Typical
C	0.203	0.381	Typical	0.008	0.015	Typical
D	22.352	23.622		0.880	0.930	
D1	20.320	20.320	Reference	0.800	0.800	Reference
E	7.620	8.382		0.300	0.330	
E1	5.588	7.874		0.220	0.310	
e1	2.540	2.540	Reference	0.100	0.100	Reference
eA	7.366	8.128	Typical	0.290	0.320	Typical
eB	7.620	10.160		0.300	0.400	
L	3.175	3.810		0.125	0.150	
N	18	18		18	18	
S	0.508	1.397		0.020	0.055	
S1	0.381	1.270		0.015	0.050	

24.7 28-Lead Ceramic CERDIP Dual In-line with Window (300 mil) (JW)

Note: For the most current package drawings, please see the Microchip Packaging Specification located at <http://www.microchip.com/packaging>



Package Group: Ceramic CERDIP Dual In-Line (CDP)

Symbol	Millimeters			Inches		
	Min	Max	Notes	Min	Max	Notes
α	0°	10°		0°	10°	
A	3.30	5.84		.130	0.230	
A1	0.38	—		0.015	—	
A2	2.92	4.95		0.115	0.195	
B	0.35	0.58		0.014	0.023	
B1	1.14	1.78	Typical	0.045	0.070	Typical
C	0.20	0.38	Typical	0.008	0.015	Typical
D	34.54	37.72		1.360	1.485	
D2	32.97	33.07	Reference	1.298	1.302	Reference
E	7.62	8.25		0.300	0.325	
E1	6.10	7.87		0.240	0.310	
e	2.54	2.54	Typical	0.100	0.100	Typical
eA	7.62	7.62	Reference	0.300	0.300	Reference
eB	—	11.43		—	0.450	
L	2.92	5.08		0.115	0.200	
N	28	28		28	28	
D1	0.13	—		0.005	—	

PIC16C6X

24.8 40-Lead Ceramic Cerdip Dual In-line with Window (600 mil) (JW)

Note: For the most current package drawings, please see the Microchip Packaging Specification located at <http://www.microchip.com/packaging>



Package Group: Ceramic Cerdip Dual In-Line (CDP)

Symbol	Millimeters			Inches		
	Min	Max	Notes	Min	Max	Notes
α	0°	10°		0°	10°	
A	4.318	5.715		0.170	0.225	
A1	0.381	1.778		0.015	0.070	
A2	3.810	4.699		0.150	0.185	
A3	3.810	4.445		0.150	0.175	
B	0.355	0.585		0.014	0.023	
B1	1.270	1.651	Typical	0.050	0.065	Typical
C	0.203	0.381	Typical	0.008	0.015	Typical
D	51.435	52.705		2.025	2.075	
D1	48.260	48.260	Reference	1.900	1.900	Reference
E	15.240	15.875		0.600	0.625	
E1	12.954	15.240		0.510	0.600	
e1	2.540	2.540	Reference	0.100	0.100	Reference
eA	14.986	16.002	Typical	0.590	0.630	Typical
eB	15.240	18.034		0.600	0.710	
L	3.175	3.810		0.125	0.150	
N	40	40		40	40	
S	1.016	2.286		0.040	0.090	
S1	0.381	1.778		0.015	0.070	

24.9 28-Lead Ceramic Side Brazed Dual In-Line with Window (300 mil) (JW)

Note: For the most current package drawings, please see the Microchip Packaging Specification located at <http://www.microchip.com/packaging>



Package Group: Ceramic Side Brazed Dual In-Line (CER)						
Symbol	Millimeters			Inches		
	Min	Max	Notes	Min	Max	Notes
α	0°	10°		0°	10°	
A	3.937	5.030		0.155	0.198	
A1	1.016	1.524		0.040	0.060	
A2	2.921	3.506		0.115	0.138	
A3	1.930	2.388		0.076	0.094	
B	0.406	0.508		0.016	0.020	
B1	1.219	1.321	Typical	0.048	0.052	
C	0.228	0.305	Typical	0.009	0.012	
D	35.204	35.916		1.386	1.414	
D1	32.893	33.147	Reference	1.295	1.305	
E	7.620	8.128		0.300	0.320	
E1	7.366	7.620		0.290	0.300	
e1	2.413	2.667	Typical	0.095	0.105	
eA	7.366	7.874	Reference	0.290	0.310	
eB	7.594	8.179		0.299	0.322	
L	3.302	4.064		0.130	0.160	
N	28	28		28	28	
S	1.143	1.397		0.045	0.055	
S1	0.533	0.737		0.021	0.029	

PIC16C6X

24.10 28-Lead Plastic Surface Mount (SSOP - 209 mil Body 5.30 mm) (SS)

Note: For the most current package drawings, please see the Microchip Packaging Specification located at <http://www.microchip.com/packaging>



Package Group: Plastic SSOP						
Symbol	Millimeters			Inches		
	Min	Max	Notes	Min	Max	Notes
α	0°	8°		0°	8°	
A	1.730	1.990		0.068	0.078	
A1	0.050	0.210		0.002	0.008	
B	0.250	0.380		0.010	0.015	
C	0.130	0.220		0.005	0.009	
D	10.070	10.330		0.396	0.407	
E	5.200	5.380		0.205	0.212	
e	0.650	0.650	Reference	0.026	0.026	Reference
H	7.650	7.900		0.301	0.311	
L	0.550	0.950		0.022	0.037	
N	28	28		28	28	
CP	-	0.102		-	0.004	

24.11 44-Lead Plastic Leaded Chip Carrier (Square) (PLCC)

Note: For the most current package drawings, please see the Microchip Packaging Specification located at <http://www.microchip.com/packaging>



Package Group: Plastic Leaded Chip Carrier (PLCC)

Symbol	Millimeters			Inches		
	Min	Max	Notes	Min	Max	Notes
A	4.191	4.572		0.165	0.180	
A1	2.413	2.921		0.095	0.115	
D	17.399	17.653		0.685	0.695	
D1	16.510	16.663		0.650	0.656	
D2	15.494	16.002		0.610	0.630	
D3	12.700	12.700	Reference	0.500	0.500	Reference
E	17.399	17.653		0.685	0.695	
E1	16.510	16.663		0.650	0.656	
E2	15.494	16.002		0.610	0.630	
E3	12.700	12.700	Reference	0.500	0.500	Reference
N	44	44		44	44	
CP	-	0.102		-	0.004	
LT	0.203	0.381		0.008	0.015	

PIC16C6X

24.12 44-Lead Plastic Surface Mount (MQFP 10x10 mm Body 1.6/0.15 mm Lead Form) (PQ)

Note: For the most current package drawings, please see the Microchip Packaging Specification located at <http://www.microchip.com/packaging>



Package Group: Plastic MQFP						
Symbol	Millimeters			Inches		
	Min	Max	Notes	Min	Max	Notes
α	0°	7°		0°	7°	
A	2.000	2.350		0.078	0.093	
A1	0.050	0.250		0.002	0.010	
A2	1.950	2.100		0.768	0.083	
b	0.300	0.450	Typical	0.011	0.018	Typical
C	0.150	0.180		0.006	0.007	
D	12.950	13.450		0.510	0.530	
D1	9.900	10.100		0.390	0.398	
D3	8.000	8.000	Reference	0.315	0.315	Reference
E	12.950	13.450		0.510	0.530	
E1	9.900	10.100		0.390	0.398	
E3	8.000	8.000	Reference	0.315	0.315	Reference
e	0.800	0.800		0.031	0.032	
L	0.730	1.030		0.028	0.041	
N	44	44		44	44	
CP	0.102	-		0.004	-	

24.13 44-Lead Plastic Surface Mount (TQFP 10x10 mm Body 1.0/0.10 mm Lead Form) (TQ)

Note: For the most current package drawings, please see the Microchip Packaging Specification located at <http://www.microchip.com/packaging>



Package Group: Plastic TQFP						
Symbol	Millimeters			Inches		
	Min	Max	Notes	Min	Max	Notes
A	1.00	1.20		0.039	0.047	
A1	0.05	0.15		0.002	0.006	
A2	0.95	1.05		0.037	0.041	
D	11.75	12.25		0.463	0.482	
D1	9.90	10.10		0.390	0.398	
E	11.75	12.25		0.463	0.482	
E1	9.90	10.10		0.390	0.398	
L	0.45	0.75		0.018	0.030	
e	0.80 BSC			0.031 BSC		
b	0.30	0.45		0.012	0.018	
b1	0.30	0.40		0.012	0.016	
c	0.09	0.20		0.004	0.008	
c1	0.09	0.16		0.004	0.006	
N	44	44		44	44	
⊖	0°	7°		0°	7°	

Note 1: Dimensions D1 and E1 do not include mold protrusion. Allowable mold protrusion is 0.25mm (0.010") per side. D1 and E1 dimensions including mold mismatch.

2: Dimension "b" does not include Dambar protrusion, allowable Dambar protrusion shall be 0.08mm (0.003")max.

3: This outline conforms to JEDEC MS-026.

PIC16C6X

24.14 Package Marking Information

18-Lead PDIP



Example



18-Lead SOIC



Example



18-Lead CERDIP Windowed



Example

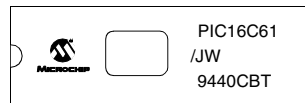

28-Lead PDIP (.300 MIL)



Example



Legend:	MM...M	Microchip part number information
	XX...X	Customer specific information*
	AA	Year code (last 2 digits of calendar year)
	BB	Week code (week of January 1 is week '01')
	C	Facility code of the plant at which wafer is manufactured. C = Chandler, Arizona, U.S.A. S = Tempe, Arizona, U.S.A.
	D ₁	Mask revision number for microcontroller
	D ₂	Mask revision number for EEPROM
	E	Assembly code of the plant or country of origin in which part was assembled.
Note:	In the event the full Microchip part number cannot be marked on one line, it will be carried over to the next line thus limiting the number of available characters for customer specific information.	

* Standard OTP marking consists of Microchip part number, year code, week code, facility code, mask revision number, and assembly code. For OTP marking beyond this, certain price adders apply. Please check with your Microchip Sales Office. For QTP devices, any special marking adders are included in QTP price.

Package Marking Information (Cont'd)

28-Lead SOIC



Example



28-Lead CERDIP Skinny Windowed

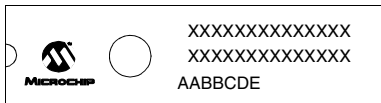

Example



28-Lead Side Brazed Skinny Windowed

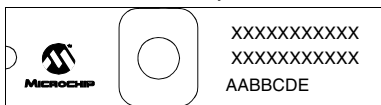

Example



28-Lead SSOP



Example



40-Lead PDIP



Example



Legend:	MM...M	Microchip part number information
	XX...X	Customer specific information*
	AA	Year code (last 2 digits of calendar year)
	BB	Week code (week of January 1 is week '01')
	C	Facility code of the plant at which wafer is manufactured. C = Chandler, Arizona, U.S.A. S = Tempe, Arizona, U.S.A.
	D ₁	Mask revision number for microcontroller
	E	Assembly code of the plant or country of origin in which part was assembled.

Note: In the event the full Microchip part number cannot be marked on one line, it will be carried over to the next line thus limiting the number of available characters for customer specific information.

* Standard OTP marking consists of Microchip part number, year code, week code, facility code, mask revision number, and assembly code. For OTP marking beyond this, certain price adders apply. Please check with your Microchip Sales Office. For QTP devices, any special marking adders are included in QTP price.

PIC16C6X

Package Marking Information (Cont'd)

40-Lead CERDIP Windowed



Example



44-Lead PLCC



Example



44-Lead MQFP



Example



44-Lead TQFP



Example



Legend:	MM...M	Microchip part number information
	XX...X	Customer specific information*
	AA	Year code (last 2 digits of calendar year)
	BB	Week code (week of January 1 is week '01')
	C	Facility code of the plant at which wafer is manufactured. C = Chandler, Arizona, U.S.A. S = Tempe, Arizona, U.S.A.
	D ₁	Mask revision number for microcontroller
	E	Assembly code of the plant or country of origin in which part was assembled.
Note:	In the event the full Microchip part number cannot be marked on one line, it will be carried over to the next line thus limiting the number of available characters for customer specific information.	

* Standard OTP marking consists of Microchip part number, year code, week code, facility code, mask revision number, and assembly code. For OTP marking beyond this, certain price adders apply. Please check with your Microchip Sales Office. For QTP devices, any special marking adders are included in QTP price.

APPENDIX A: MODIFICATIONS

The following are the list of modifications over the PIC16C5X microcontroller family:

1. Instruction word length is increased to 14-bits. This allows larger page sizes both in program memory (2K now as opposed to 512 before) and register file (128 bytes now versus 32 bytes before).
2. A PC high latch register (PCLATH) is added to handle program memory paging. PA2, PA1, PA0 bits are removed from STATUS register.
3. Data memory paging is redefined slightly. STATUS register is modified.
4. Four new instructions have been added: RETURN, RETFIE, ADDLW, and SUBLW. Two instructions TRIS and OPTION are being phased out although they are kept for compatibility with PIC16C5X.
5. OPTION and TRIS registers are made addressable.
6. Interrupt capability is added. Interrupt vector is at 0004h.
7. Stack size is increased to 8 deep.
8. Reset vector is changed to 0000h.
9. Reset of all registers is revisited. Five different reset (and wake-up) types are recognized. Registers are reset differently.
10. Wake-up from SLEEP through interrupt is added.
11. Two separate timers, Oscillator Start-up Timer (OST) and Power-up Timer (PWRT), are included for more reliable power-up. These timers are invoked selectively to avoid unnecessary delays on power-up and wake-up.
12. PORTB has weak pull-ups and interrupt on change feature.
13. Timer0 pin is also a port pin (RA4/T0CKI) now.
14. FSR is made a full 8-bit register.
15. "In-circuit programming" is made possible. The user can program PIC16CXX devices using only five pins: VDD, VSS, VPP, RB6 (clock) and RB7 (data in/out).
16. Power Control register (PCON) is added with a Power-on Reset status bit ($\overline{\text{POR}}$). (Not on the PIC16C61).
17. Brown-out Reset has been added to the following devices:
PIC16C62A/R62/63/R63/64A/R64/65A/R65/66/67.

APPENDIX B: COMPATIBILITY

To convert code written for PIC16C5X to PIC16CXX, the user should take the following steps:

1. Remove any program memory page select operations (PA2, PA1, PA0 bits) for CALL, GOTO.
2. Revisit any computed jump operations (write to PC or add to PC, etc.) to make sure page bits are set properly under the new scheme.
3. Eliminate any data memory page switching. Redefine data variables to reallocate them.
4. Verify all writes to STATUS, OPTION, and FSR registers since these have changed.
5. Change reset vector to 0000h.

PIC16C6X

APPENDIX C: WHAT'S NEW

Added PIC16CR63 and PIC16CR65 devices.

Added PIC16C66 and PIC16C67 devices. The PIC16C66/67 devices have 368 bytes of data memory distributed in 4 banks and 8K of program memory in 4 pages. These two devices have an enhanced SPI that supports both clock phase and polarity. The USART has been enhanced.

When upgrading to the PIC16C66/67 please note that the upper 16 bytes of data memory in banks 1,2, and 3 are mapped into bank 0. This may require relocation of data memory usage in the user application code.

Q-cycles for instruction execution were added to Section 14.0 Instruction Set Summary.

APPENDIX D: WHAT'S CHANGED

Minor changes, spelling and grammatical changes.

Divided SPI section into SPI for the PIC16C66/67 (Section 11.3) and SPI for all other devices (Section 11.2).

Added the following note for the USART. This applies to all devices except the PIC16C66 and PIC16C67.

For the PIC16C63/R63/65/65A/R65 the asynchronous high speed mode (BRGH = 1) may experience a high rate of receive errors. It is recommended that BRGH = 0. If you desire a higher baud rate than BRGH = 0 can support, refer to the device errata for additional information or use the PIC16C66/67.

APPENDIX E: REVISION E

January 2013 - Added a note to each package drawing.

APPENDIX F: PIC16/17 MICROCONTROLLERS

F.1 PIC12CXXX Family of Devices

		PIC12C508	PIC12C509	PIC12C671	PIC12C672
Clock	Maximum Frequency of Operation (MHz)	4	4	4	4
	Memory	EPROM Program Memory	512 x 12	1024 x 12	1024 x 14
	Data Memory (bytes)	25	41	128	128
Peripherals	Timer Module(s)	TMR0	TMR0	TMR0	TMR0
	A/D Converter (8-bit) Channels	—	—	4	4
Features	Wake-up from SLEEP on pin change	Yes	Yes	Yes	Yes
	I/O Pins	5	5	5	5
	Input Pins	1	1	1	1
	Internal Pull-ups	Yes	Yes	Yes	Yes
	Voltage Range (Volts)	2.5-5.5	2.5-5.5	2.5-5.5	2.5-5.5
	In-Circuit Serial Programming	Yes	Yes	Yes	Yes
	Number of Instructions	33	33	35	35
Packages	8-pin DIP, SOIC	8-pin DIP, SOIC	8-pin DIP, SOIC	8-pin DIP, SOIC	

All PIC12C5XX devices have Power-on Reset, selectable Watchdog Timer, selectable code protect and high I/O current capability. All PIC12C5XX devices use serial programming with data pin GP1 and clock pin GP0.

F.2 PIC14C000 Family of Devices

		PIC14C000
Clock	Maximum Frequency of Operation (MHz)	20
Memory	EPROM Program Memory (x14 words)	4K
	Data Memory (bytes)	192
	Timer Module(s)	TMR0 ADTMR
Peripherals	Serial Port(s) (SPI/I ² C, USART)	I ² C with SMBus Support
Features	Slope A/D Converter Channels	8 External; 6 Internal
	Interrupt Sources	11
	I/O Pins	22
	Voltage Range (Volts)	2.7-6.0
	In-Circuit Serial Programming	Yes
	Additional On-chip Features	Internal 4MHz Oscillator, Bandgap Reference, Temperature Sensor, Calibration Factors, Low Voltage Detector, SLEEP, HIBERNATE, Comparators with Programmable References (2)
Packages	28-pin DIP (.300 mil), SOIC, SSOP	

PIC16C6X

F.3 PIC16C15X Family of Devices

		PIC16C154	PIC16CR154	PIC16C156	PIC16CR156	PIC16C158	PIC16CR158
Clock	Maximum Frequency of Operation (MHz)	20	20	20	20	20	20
Memory	EPROM Program Memory (x12 words)	512	—	1K	—	2K	—
	ROM Program Memory (x12 words)	—	512	—	1K	—	2K
	RAM Data Memory (bytes)	25	25	25	25	73	73
Peripherals	Timer Module(s)	TMR0	TMR0	TMR0	TMR0	TMR0	TMR0
Features	I/O Pins	12	12	12	12	12	12
	Voltage Range (Volts)	3.0-5.5	2.5-5.5	3.0-5.5	2.5-5.5	3.0-5.5	2.5-5.5
	Number of Instructions	33	33	33	33	33	33
	Packages	18-pin DIP, SOIC; 20-pin SSOP	18-pin DIP, SOIC; 20-pin SSOP	18-pin DIP, SOIC; 20-pin SSOP	18-pin DIP, SOIC; 20-pin SSOP	18-pin DIP, SOIC; 20-pin SSOP	18-pin DIP, SOIC; 20-pin SSOP

All PIC16/17 Family devices have Power-on Reset, selectable Watchdog Timer, selectable code protect and high I/O current capability.

F.4 PIC16C5X Family of Devices

		PIC16C52	PIC16C54	PIC16C54A	PIC16CR54A	PIC16C55	PIC16C56
Clock	Maximum Frequency of Operation (MHz)	4	20	20	20	20	20
Memory	EPROM Program Memory (x12 words)	384	512	512	—	512	1K
	ROM Program Memory (x12 words)	—	—	—	512	—	—
	RAM Data Memory (bytes)	25	25	25	25	24	25
Peripherals	Timer Module(s)	TMR0	TMR0	TMR0	TMR0	TMR0	TMR0
Features	I/O Pins	12	12	12	12	20	12
	Voltage Range (Volts)	2.5-6.25	2.5-6.25	2.0-6.25	2.0-6.25	2.5-6.25	2.5-6.25
	Number of Instructions	33	33	33	33	33	33
	Packages	18-pin DIP, SOIC	18-pin DIP, SOIC; 20-pin SSOP	18-pin DIP, SOIC; 20-pin SSOP	18-pin DIP, SOIC; 20-pin SSOP	28-pin DIP, SOIC, SSOP	18-pin DIP, SOIC; 20-pin SSOP

		PIC16C57	PIC16CR57B	PIC16C58A	PIC16CR58A
Clock	Maximum Frequency of Operation (MHz)	20	20	20	20
Memory	EPROM Program Memory (x12 words)	2K	—	2K	—
	ROM Program Memory (x12 words)	—	2K	—	2K
	RAM Data Memory (bytes)	72	72	73	73
Peripherals	Timer Module(s)	TMR0	TMR0	TMR0	TMR0
Features	I/O Pins	20	20	12	12
	Voltage Range (Volts)	2.5-6.25	2.5-6.25	2.0-6.25	2.5-6.25
	Number of Instructions	33	33	33	33
	Packages	28-pin DIP, SOIC, SSOP	28-pin DIP, SOIC, SSOP	18-pin DIP, SOIC; 20-pin SSOP	18-pin DIP, SOIC; 20-pin SSOP

All PIC16/17 Family devices have Power-on Reset, selectable Watchdog Timer (except PIC16C52), selectable code protect and high I/O current capability.

F.5 PIC16C55X Family of Devices

		PIC16C554	PIC16C556 ⁽¹⁾	PIC16C558
Clock	Maximum Frequency of Operation (MHz)	20	20	20
Memory	EPROM Program Memory (x14 words)	512	1K	2K
	Data Memory (bytes)	80	80	128
Peripherals	Timer Module(s)	TMR0	TMR0	TMR0
	Comparators(s)	—	—	—
	Internal Reference Voltage	—	—	—
Features	Interrupt Sources	3	3	3
	I/O Pins	13	13	13
	Voltage Range (Volts)	2.5-6.0	2.5-6.0	2.5-6.0
	Brown-out Reset	—	—	—
	Packages	18-pin DIP, SOIC; 20-pin SSOP	18-pin DIP, SOIC; 20-pin SSOP	18-pin DIP, SOIC; 20-pin SSOP

All PIC16/17 Family devices have Power-on Reset, selectable Watchdog Timer, selectable code protect and high I/O current capability. All PIC16C5XX Family devices use serial programming with clock pin RB6 and data pin RB7.
 Note 1: Please contact your local Microchip sales office for availability of these devices.

F.6 PIC16C62X and PIC16C64X Family of Devices

		PIC16C620	PIC16C621	PIC16C622	PIC16C642	PIC16C662
Clock	Maximum Frequency of Operation (MHz)	20	20	20	20	20
Memory	EPROM Program Memory (x14 words)	512	1K	2K	4K	4K
	Data Memory (bytes)	80	80	128	176	176
Peripherals	Timer Module(s)	TMR0	TMR0	TMR0	TMR0	TMR0
	Comparators(s)	2	2	2	2	2
	Internal Reference Voltage	Yes	Yes	Yes	Yes	Yes
Features	Interrupt Sources	4	4	4	4	5
	I/O Pins	13	13	13	22	33
	Voltage Range (Volts)	2.5-6.0	2.5-6.0	2.5-6.0	3.0-6.0	3.0-6.0
	Brown-out Reset	Yes	Yes	Yes	Yes	Yes
	Packages	18-pin DIP, SOIC; 20-pin SSOP	18-pin DIP, SOIC; 20-pin SSOP	18-pin DIP, SOIC; 20-pin SSOP	28-pin PDIP, SOIC, Windowed CDIP	40-pin PDIP, Windowed CDIP; 44-pin PLCC, MQFP

All PIC16/17 Family devices have Power-on Reset, selectable Watchdog Timer, selectable code protect and high I/O current capability. All PIC16C62X and PIC16C64X Family devices use serial programming with clock pin RB6 and data pin RB7.

PIC16C6X

F.7 PIC16C7XX Family of Devices

		PIC16C710	PIC16C71	PIC16C711	PIC16C715	PIC16C72	PIC16CR72 ⁽¹⁾
Clock	Maximum Frequency of Operation (MHz)	20	20	20	20	20	20
	Memory						
	EPROM Program Memory (x14 words)	512	1K	1K	2K	2K	—
	ROM Program Memory (14K words)	—	—	—	—	—	2K
	Data Memory (bytes)	36	36	68	128	128	128
Peripherals	Timer Module(s)	TMR0	TMR0	TMR0	TMR0	TMR0, TMR1, TMR2	TMR0, TMR1, TMR2
	Capture/Compare/PWM Module(s)	—	—	—	—	1	1
	Serial Port(s) (SPI/I ² C, USART)	—	—	—	—	SPI/I ² C	SPI/I ² C
	Parallel Slave Port	—	—	—	—	—	—
	A/D Converter (8-bit) Channels	4	4	4	4	5	5
Features	Interrupt Sources	4	4	4	4	8	8
	I/O Pins	13	13	13	13	22	22
	Voltage Range (Volts)	3.0-6.0	3.0-6.0	3.0-6.0	3.0-5.5	2.5-6.0	3.0-5.5
	In-Circuit Serial Programming	Yes	Yes	Yes	Yes	Yes	Yes
	Brown-out Reset	Yes	—	Yes	Yes	Yes	Yes
	Packages	18-pin DIP, SOIC, 20-pin SSOP	18-pin DIP, SOIC	18-pin DIP, SOIC, 20-pin SSOP	18-pin DIP, SOIC, 20-pin SSOP	28-pin SDIP, SOIC, SSOP	28-pin SDIP, SOIC, SSOP

		PIC16C73A	PIC16C74A	PIC16C76	PIC16C77
Clock	Maximum Frequency of Operation (MHz)	20	20	20	20
	Memory				
	EPROM Program Memory (x14 words)	4K	4K	8K	8K
	Data Memory (bytes)	192	192	368	368
Peripherals	Timer Module(s)	TMR0, TMR1, TMR2	TMR0, TMR1, TMR2	TMR0, TMR1, TMR2	TMR0, TMR1, TMR2
	Capture/Compare/PWM Module(s)	2	2	2	2
	Serial Port(s) (SPI/I ² C, USART)	SPI/I ² C, USART	SPI/I ² C, USART	SPI/I ² C, USART	SPI/I ² C, USART
	Parallel Slave Port	—	Yes	—	Yes
	A/D Converter (8-bit) Channels	5	8	5	8
Features	Interrupt Sources	11	12	11	12
	I/O Pins	22	33	22	33
	Voltage Range (Volts)	2.5-6.0	2.5-6.0	2.5-6.0	2.5-6.0
	In-Circuit Serial Programming	Yes	Yes	Yes	Yes
	Brown-out Reset	Yes	Yes	Yes	Yes
	Packages	28-pin SDIP, SOIC	40-pin DIP, 44-pin PLCC, MQFP, TQFP	28-pin SDIP, SOIC	40-pin DIP, 44-pin PLCC, MQFP, TQFP

All PIC16/17 Family devices have Power-on Reset, selectable Watchdog Timer, selectable code protect and high I/O current capability. All PIC16C7XX Family devices use serial programming with clock pin RB6 and data pin RB7.

Note 1: Please contact your local Microchip sales office for availability of these devices.

F.8 PIC16C8X Family of Devices

		PIC16F83	PIC16CR83	PIC16F84	PIC16CR84
Clock	Maximum Frequency of Operation (MHz)	10	10	10	10
	Memory	Flash Program Memory	512	—	1K
Memory	EEPROM Program Memory	—	—	—	—
	ROM Program Memory	—	512	—	1K
	Data Memory (bytes)	36	36	68	68
	Data EEPROM (bytes)	64	64	64	64
Peripherals	Timer Module(s)	TMR0	TMR0	TMR0	TMR0
	Features	Interrupt Sources	4	4	4
Features	I/O Pins	13	13	13	13
	Voltage Range (Volts)	2.0-6.0	2.0-6.0	2.0-6.0	2.0-6.0
	Packages	18-pin DIP, SOIC	18-pin DIP, SOIC	18-pin DIP, SOIC	18-pin DIP, SOIC

All PIC16/17 Family devices have Power-on Reset, selectable Watchdog Timer, selectable code protect and high I/O current capability. All PIC16C8X Family devices use serial programming with clock pin RB6 and data pin RB7.

F.9 PIC16C9XX Family Of Devices

		PIC16C923	PIC16C924
Clock	Maximum Frequency of Operation (MHz)	8	8
	Memory	EPROM Program Memory	4K
Data Memory (bytes)		176	176
Peripherals	Timer Module(s)	TMR0, TMR1, TMR2	TMR0, TMR1, TMR2
	Capture/Compare/PWM Module(s)	1	1
	Serial Port(s) (SPI/I ² C, USART)	SPI/I ² C	SPI/I ² C
	Parallel Slave Port	—	—
	A/D Converter (8-bit) Channels	—	5
	LCD Module	4 Com, 32 Seg	4 Com, 32 Seg
Features	Interrupt Sources	8	9
	I/O Pins	25	25
	Input Pins	27	27
	Voltage Range (Volts)	3.0-6.0	3.0-6.0
	In-Circuit Serial Programming	Yes	Yes
	Brown-out Reset	—	—
	Packages	64-pin SDIP ⁽¹⁾ , TQFP; 68-pin PLCC, Die	64-pin SDIP ⁽¹⁾ , TQFP; 68-pin PLCC, Die

All PIC16/17 Family devices have Power-on Reset, selectable Watchdog Timer, selectable code protect and high I/O current capability. All PIC16C9XX Family devices use serial programming with clock pin RB6 and data pin RB7.

PIC16C6X

F.10 PIC17CXXX Family of Devices

		PIC17C42A	PIC17CR42	PIC17C43	PIC17CR43	PIC17C44
Clock	Maximum Frequency of Operation (MHz)	33	33	33	33	33
Memory	EPROM Program Memory (words)	2K	—	4K	—	8K
	ROM Program Memory (words)	—	2K	—	4K	—
	RAM Data Memory (bytes)	232	232	454	454	454
Peripherals	Timer Module(s)	TMR0, TMR1, TMR2, TMR3	TMR0, TMR1, TMR2, TMR3	TMR0, TMR1, TMR2, TMR3	TMR0, TMR1, TMR2, TMR3	TMR0, TMR1, TMR2, TMR3
	Captures/PWM Module(s)	2	2	2	2	2
	Serial Port(s) (USART)	Yes	Yes	Yes	Yes	Yes
Features	Hardware Multiply	Yes	Yes	Yes	Yes	Yes
	External Interrupts	Yes	Yes	Yes	Yes	Yes
	Interrupt Sources	11	11	11	11	11
	I/O Pins	33	33	33	33	33
	Voltage Range (Volts)	2.5-6.0	2.5-6.0	2.5-6.0	2.5-6.0	2.5-6.0
	Number of Instructions	58	58	58	58	58
	Packages	40-pin DIP; 44-pin PLCC, MQFP, TQFP	40-pin DIP; 44-pin PLCC, MQFP, TQFP	40-pin DIP; 44-pin PLCC, MQFP, TQFP	40-pin DIP; 44-pin PLCC, MQFP, TQFP	40-pin DIP; 44-pin PLCC, MQFP, TQFP

		PIC17C752	PIC17C756
Clock	Maximum Frequency of Operation (MHz)	33	33
Memory	EPROM Program Memory (words)	8K	16K
	ROM Program Memory (words)	—	—
	RAM Data Memory (bytes)	454	902
Peripherals	Timer Module(s)	TMR0, TMR1, TMR2, TMR3	TMR0, TMR1, TMR2, TMR3
	Captures/PWM Module(s)	4/3	4/3
	Serial Port(s) (USART)	2	2
Features	Hardware Multiply	Yes	Yes
	External Interrupts	Yes	Yes
	Interrupt Sources	18	18
	I/O Pins	50	50
	Voltage Range (Volts)	3.0-6.0	3.0-6.0
	Number of Instructions	58	58
	Packages	64-pin DIP; 68-pin LCC, 68-pin TQFP	64-pin DIP; 68-pin LCC, 68-pin TQFP

All PIC16/17 Family devices have Power-on Reset, selectable Watchdog Timer, selectable code protect and high I/O current capability.

PIN COMPATIBILITY

Devices that have the same package type and VDD, Vss and MCLR pin locations are said to be pin compatible. This allows these different devices to operate in the same socket. Compatible devices may only requires minor software modification to allow proper operation in the application socket (ex., PIC16C56 and PIC16C61 devices). Not all devices in the same package size are pin compatible; for example, the PIC16C62 is compatible with the PIC16C63, but not the PIC16C55.

Pin compatibility does not mean that the devices offer the same features. As an example, the PIC16C54 is pin compatible with the PIC16C71, but does not have an A/D converter, weak pull-ups on PORTB, or interrupts.

TABLE F-1: PIN COMPATIBLE DEVICES

Pin Compatible Devices	Package
PIC12C508, PIC12C509, PIC12C671, PIC12C672	8-pin
PIC16C154, PIC16CR154, PIC16C156, PIC16CR156, PIC16C158, PIC16CR158, PIC16C52, PIC16C54, PIC16C54A, PIC16CR54A, PIC16C56, PIC16C58A, PIC16CR58A, PIC16C61, PIC16C554, PIC16C556, PIC16C558 PIC16C620, PIC16C621, PIC16C622 PIC16C641, PIC16C642, PIC16C661, PIC16C662 PIC16C710, PIC16C711, PIC16C715 PIC16F83, PIC16CR83, PIC16F84A, PIC16CR84	18-pin, 20-pin
PIC16C55, PIC16C57, PIC16CR57B	28-pin
PIC16CR62, PIC16C62A, PIC16C63, PIC16CR63, PIC16C66, PIC16C72, PIC16C73A, PIC16C76	28-pin
PIC16CR64, PIC16C64A, PIC16C65A, PIC16CR65, PIC16C67, PIC16C74A, PIC16C77	40-pin
PIC17CR42, PIC17C42A, PIC17C43, PIC17CR43, PIC17C44	40-pin
PIC16C923, PIC16C924	64/68-pin
PIC17C756, PIC17C752	64/68-pin

PIC16C6X

NOTES:

INDEX

Numerics

9-bit Receive Enable bit, RX9	106
9-bit Transmit Enable bit, TX9	105
9th bit of received data, RX9D	106
9th bit of transmit data, TX9D	105

A

Absolute Maximum	
Ratings	163, 183, 199, 215, 231, 247, 263
ACK	96, 100, 101
ALU	9
Application Notes	
AN552 (Implementing Wake-up on Key Stroke)	53
AN556 (Implementing a Table Read)	48
AN594 (Using the CCP Modules)	77
Architectural Overview	9

B

Baud Rate Formula	107
Baud Rate Generator	107
Baud Rates	
Asynchronous Mode	108
Error, Calculating	107
RX Pin Sampling, Timing Diagrams	110, 111
Sampling	110
Synchronous Mode	108
BF	84, 89, 100

Block Diagrams

Capture Mode Operation	78
Compare Mode	79
Crystal Oscillator, Ceramic Resonator	125
External Brown-out Protection	135
External Parallel Resonant Crystal Circuit	127
External Power-on Reset	135
External Series Resonant Crystal Circuit	127
I ² C Mode	99
In-circuit Programming Connections	142
Interrupt Logic	137
On-chip Reset Circuit	128
Parallel Slave Port, PORTD-PORTE	61
PIC16C61	10
PIC16C62	11
PIC16C62A	11
PIC16C63	12
PIC16C64	11
PIC16C64A	11
PIC16C65	12
PIC16C65A	12
PIC16C66	13
PIC16C67	13
PIC16CR62	11
PIC16CR63	12
PIC16CR64	11
PIC16CR65	12
PORTC	55
PORTD (I/O Mode)	57
PORTE (I/O Mode)	58
PWM	80
RA3:RA0 pins	51
RA4/T0CK1 pin	51
RA5 pin	51
RB3:RB0 pins	54
RB7:RB4 pins	53, 54
RC Oscillator Mode	127

SPI Master/Slave Connection	87
SSP in I ² C Mode	99
SSP in SPI Mode	86, 91
Timer0	65
Timer0/WDT Prescaler	68
Timer1	72
Timer2	75
USART Receive	114
USART Transmit	112
Watchdog Timer	140
BOR	129
$\overline{\text{BOR}}$	47, 131
BRGH	105
Brown-out Reset (BOR)	129
Brown-out Reset Status bit, $\overline{\text{BOR}}$	47
Buffer Full Status bit, BF	84, 89

C

C	35
C Compiler	161
Capture	
Block Diagram	78
Mode	78
Pin Configuration	78
Prescaler	79
Software Interrupt	78
Capture Interrupt	78
Capture/Compare/PWM (CCP)	
Capture Mode	78
Capture Mode Block Diagram	78
CCP1	77
CCP2	77
Compare Mode	79
Compare Mode Block Diagram	79
Overview	63
Prescaler	79
PWM Block Diagram	80
PWM Mode	80
PWM, Example Frequencies/Resolutions	81
Section	77
Carry	9
Carry bit	35
CCP Module Interaction	77
CCP pin Configuration	78
CCP to Timer Resource Use	77
CCP1 Interrupt Enable bit, CCP1IE	38
CCP1 Interrupt Flag bit, CCP1IF	41
CCP1 Mode Select bits	78
CCP1CON	24, 26, 28, 30, 32, 34
CCP1IE	38
CCP1IF	41
CCP1M3:CCM1M0	78
CCP1X:CCP1Y	78
CCP2 Interrupt Enable bit, CCP2IE	45
CCP2 Interrupt Flag bit, CCP2IF	46
CCP2 Mode Select bits	78
CCP2CON	24, 26, 28, 30, 32, 34
CCP2IE	45
CCP2IF	46
CCP2M3:CCP2M0	78
CCP2X:CCP2Y	78
CCPR1H	24, 26, 28, 30, 32, 34
CCPR1L	24, 26, 28, 30, 32, 34
CCPR2H	24, 26, 28, 30, 32, 34
CCPR2L	24, 26, 28, 30, 32, 34
CKE	89
CKP	85, 90

PIC16C6X

Clearing Interrupts.....	53
Clock Polarity Select bit, CKP	85, 90
Clock Polarity, SPI Mode	87
Clock Source Select bit, CSRC	105
Clocking Scheme	18
Code Examples	
Changing Between Capture Prescalers	79
Ensuring Interrupts are Globally Disabled	136
Indirect Addressing	49
Initializing PORTA	51
Initializing PORTB	53
Initializing PORTC	55
Loading the SSPBUF Register	86
Loading the SSPBUF register	91
Reading a 16-bit Free-running Timer	73
Read-Modify-Write on an I/O Port	60
Saving Status, W, and PCLATH Registers	139
Subroutine Call, Page0 to Page1	49
Code Protection	142
Compare	
Block Diagram	79
Mode	79
Pin Configuration	79
Software Interrupt	79
Special Event Trigger	79
Computed GOTO	48
Configuration Bits	123
Configuration Word, Diagram	124
Connecting Two Microcontrollers	87
Continuous Receive Enable bit, CREN	106
CREN	106
CSRC	105
D	
D/ \bar{A}	84, 89
Data/Address bit, D/ \bar{A}	84, 89
Data Memory	
Organization	20
Section	20
Data Sheet	
Compatibility	307
Modifications	307
What's New	308
DC	35
DC CHARACTERISTICS .. 164, 184, 200, 216, 232, 248, 264	
Development Support	159
Development Tools	159
Device Drawings	
18-Lead Ceramic CERDIP Dual In-line with Window (300 mil)	296
18-Lead Plastic Dual In-line (300 mil)	291
18-Lead Plastic Surface Mount (SOIC - Wide, 300 mil Body)	294
28-Lead Ceramic CERDIP Dual In-line with Window (300 mil)	297
28-Lead Ceramic Side Brazed Dual In-Line with Window (300 mil)	299
28-Lead Plastic Dual In-line (300 mil)	292
28-Lead Plastic Surface Mount (SOIC - Wide, 300 mil Body)	295
28-Lead Plastic Surface Mount (SSOP - 209 mil Body 5.30 mm)	300
40-Lead Ceramic CERDIP Dual In-line with Window (600 mil)	298
40-Lead Plastic Dual In-line (600 mil)	293
44-Lead Plastic Leaded Chip Carrier (Square)	301
44-Lead Plastic Surface Mount (MQFP 10x10 mm Body 1.6/0.15 mm Lead Form)	302, 303
Device Varieties	7
Digit Carry	9
Digit Carry bit	35
Direct Addressing	49
E	
Electrical Characteristics .. 163, 183, 199, 215, 231, 247, 263	
External Clock Synchronization, TMR0	67
F	
Family of Devices	
PIC12CXXX	309
PIC14C000	309
PIC16C15X	310
PIC16C55X	311
PIC16C5X	310
PIC16C62X and PIC16C64X	311
PIC16C6X	6
PIC16C7XX	312
PIC16C8X	313
PIC16C9XX	313
PIC17CXX	314
FERR	106
Framing Error bit, FERR	106
FSR	24, 25, 26, 27, 28, 29, 30, 31, 32, 33, 34
Fuzzy Logic Dev. System (<i>fuzzyTECH</i> [®] -MP)	159, 161
G	
General Description	5
General Purpose Registers	20
GIE	37
Global Interrupt Enable bit, GIE	37
Graphs	
PIC16C6X	281
PIC16C61	173
H	
High Baud Rate Select bit, BRGH	105
I	
I/O Ports, Section	51
I ² C	
Addressing	100
Addressing I ² C Devices	96
Arbitration	98
Block Diagram	99
Clock Synchronization	98
Combined Format	97
I ² C Operation	99
I ² C Overview	95
Initiating and Terminating Data Transfer	95
Master Mode	103
Master-Receiver Sequence	97
Master-Transmitter Sequence	97
Mode	99
Mode Selection	99
Multi-master	98
Multi-Master Mode	103
Reception	101
Reception Timing Diagram	101
SCL and SDA pins	100
Slave Mode	100
START	95
STOP	95, 96

Transfer Acknowledge	96	RBO/INT Timing Diagram	138
Transmission	102	Receive Flag bit	42
ID Locations	142	Timer0	65
IDLE_MODE	104	Timer0, Timing	66
In-circuit Serial Programming	142	Timing Diagram, Wake-up from SLEEP	142
INDF	24, 26, 28, 30, 32, 34	TMR0	138
Indirect Addressing	49	USART Receive Enable bit	39
Instruction Cycle	18	USART Transmit Enable bit	39
Instruction Flow/Pipelining	18	USART Transmit Flag bit	42
Instruction Format	143	Wake-up	141
Instruction Set		Wake-up from SLEEP	141
ADDLW	145	INTF	37
ADDWF	145	IRP	35
ANDLW	145	L	
ANDWF	145	Loading the Program Counter	48
BCF	146	M	
BSF	146	MPASM Assembler	159, 160
BTFSC	146	MPLAB-C	161
BTFSS	147	MPSIM Software Simulator	159, 161
CALL	147	O	
CLRF	148	OERR	106
CLRW	148	One-Time-Programmable Devices	7
CLRWDT	148	OPCODE	143
COMF	149	Open-Drain	51
DECF	149	OPTION	25, 27, 29, 31, 33, 34
DECFSZ	149	Oscillator Start-up Timer (OST)	123, 129
GOTO	150	Oscillators	
INCF	150	Block Diagram, External Parallel Resonant Crystal	127
INCFSZ	151	Capacitor Selection	73
IORLW	151	Configuration	125
IORWF	152	External Crystal Circuit	127
MOVF	152	HS	125, 130
MOVLW	152	LP	125, 130
MOVWF	152	RC, Block Diagram	127
NOP	153	RC, Section	127
OPTION	153	XT	125
RETFIE	153	Overrun Error bit, OERR	106
RETLW	154	P	
RETURN	154	P	84, 89
RLF	155	Packaging Information	291
RRF	155	Parallel Slave Port	
SLEEP	156	PORTD	57
SUBLW	156	Section	61
SUBWF	157	Parallel Slave Port Interrupt Flag bit, PSPIF	43
SWAPF	157	Parallel Slave Port Read/Write Interrupt Enable bit, PSPIE	39
TRIS	157	PCL	24, 25, 26, 27, 28, 29, 30, 31, 32, 33, 34
XORLW	158	PCLATH	24, 25, 26, 27, 28, 29, 30, 31, 32, 33, 34, 48
XORWF	158	PCON	25, 27, 29, 31, 33, 34, 130
Section	143	PD	35, 131
Summary Table	144	PEIE	37
INTCON	24, 25, 26, 27, 28, 29, 30, 31, 32, 33, 34	Peripheral Interrupt Enable bit, PEIE	37
INTE	37	PICDEM-1 Low-Cost PIC16/17 Demo Board	159, 160
INTEDG	36	PICDEM-2 Low-Cost PIC16CXX Demo Board	159, 160
Interrupt Edge Select bit, INTEDG	36	PICDEM-3 Low-Cost PIC16C9XXX Demo Board	160
Interrupt on Change Feature	53	PICMASTER In-Circuit Emulator	159
Interrupts		PICSTART Low-Cost Development System	159
Section	136	PIE1	25, 27, 29, 31, 33, 34
CCP	78	PIE2	25, 27, 29, 31, 33, 34
CCP1	38	Pin Compatible Devices	315
CCP1 Flag bit	41	Pin Functions	
CCP2 Enable bit	45	MCLR/VPP	16
CCP2 Flag bit	46		
Context Saving	139		
Parallel Slave Port Flag bit	43		
Parallel Slave Prot Read/Write Enable bit	39		
Port RB	53		
RBO/INT	54, 138		

PIC16C6X

OSC1/CLKIN.....	16	Map.....	19, 20
OSC2/CLKOUT.....	16	Organization.....	19
PORTA.....	52	Paging.....	48
PORTB.....	54	Section.....	19
PORTC.....	55	Programming While In-circuit.....	142
PORTD.....	57	PS2:PS0.....	36
PORTE.....	59	PSA.....	36
RA4/T0CKI.....	16, 52	PSPIE.....	39
RA5/SS.....	16, 52	PSPIF.....	43
RB0/INT.....	16, 54	Pull-ups.....	53
RB6.....	142	PUSH.....	48
RB7.....	142	PWM	
RC0/T1OSI/T1CKI.....	55	Block Diagram.....	80
RC0/T1OSO/T1CKI.....	16, 55	Calculations.....	81
RC1/T1OSI.....	55	Mode.....	80
RC1/T1OSI/CCP2.....	16, 55	Output Timing.....	80
RC1/T1OSO.....	55	PWM Least Significant bits.....	78
RC2/CCP1.....	16, 55, 56		
RC3/SCK/SCL.....	16, 55, 56	Q	
RC4/SDI/SDA.....	16, 55, 56	Quadrature Clocks.....	18
RC5/SDO.....	16, 55, 56	Quick-Turnaround-Production.....	7
RC6/TX/CK.....	16, 55, 56, 105–120		
RC7/RX/DT.....	16, 55, 56, 105–120	R	
RD7/PSP7:RD0/PSP0.....	17, 57	R/W bit.....	84, 89, 96, 100, 101, 102
RE0/RD.....	17, 59, 61	RA0 pin.....	51
RE1/WR.....	17, 59, 61	RA1 pin.....	51
RE2/CS.....	17, 59, 61	RA2 pin.....	51
SCK.....	86–88	RA3 pin.....	51
SDI.....	86–88	RA4/T0CKI pin.....	51
SDO.....	86–88	RA5 pin.....	51
SS.....	86–88	RB Port Change Interrupt Enable bit, RBIE.....	37
VDD.....	17	RB Port Change Interrupt Flag bit, RBIF.....	37
VSS.....	17	RB0.....	54
PIR1.....	24, 26, 28, 30, 32, 34	RB0/INT.....	138
PIR2.....	24, 26, 28, 30, 32, 34	RB0/INT External Interrupt Enable bit, INTE.....	37
POP.....	48	RB0/INT External Interrupt Flag bit, INTF.....	37
POR.....	47, 131	RB1.....	54
POR Time-Out Sequence on Power-Up.....	134	RB2.....	54
Port RB Interrupt.....	53	RB3.....	54
PORTA.....	24, 26, 28, 30, 32, 34, 51	RB4.....	53
PORTB.....	24, 26, 28, 30, 32, 34, 53	RB5.....	53
PORTB Interrupt on Change.....	138	RB6.....	53
PORTB Pull-up Enable bit, RBPU.....	36	RB7.....	53
PORTC.....	24, 26, 28, 30, 32, 34, 55	RBIE.....	37
PORTD.....	24, 26, 28, 30, 32, 34, 57	RBIF.....	37
PORTE.....	24, 26, 28, 30, 32, 34, 58	RBPU.....	36, 53
Ports		RC Oscillator.....	130
Bi-directional.....	60	RCIE.....	39
I/O Programming Considerations.....	60	RCIF.....	42
PORTA.....	16	RCREG.....	24, 26, 28, 30, 32, 34
PORTB.....	16	RCSTA.....	24, 26, 28, 30, 32, 34, 106
PORTC.....	16	RCV_MODE.....	104
PORTD.....	17	Read Only Memory.....	7
PORTE.....	17	Read/Write bit Information, R/W.....	84, 89
Successive Operations on an I/O Port.....	60	Receive and Control Register.....	106
Power/Control Status Register, PCON.....	130	Receive Overflow Detect bit, SSPOV.....	85
Power-down bit.....	35	Receive Overflow Indicator bit, SSPOV.....	90
Power-down Mode.....	141	Register Bank Select bit, Indirect.....	35
Power-on Reset (POR).....	129	Register Bank Select bits. Direct.....	35
Power-on Reset Status bit, POR.....	47		
Power-up Timer (PWRT).....	123, 129		
PR2.....	25, 27, 29, 31, 33, 34		
Prescaler.....	68		
Prescaler Assignment bit, PSA.....	36		
Prescaler Rate Select bits, PS2:PS0.....	36		
PRO MATE Universal Programmer.....	159		
Program Memory			

Registers

CCP1CON		PORTD	
Diagram	78	Section	57
Section	78	Summary	28, 30, 32
Summary	24, 26, 28, 30, 32	PORTE	
CCP2CON		Section	58
Diagram	78	Summary	28, 30, 32
Section	78	PR2	
Summary	26, 30, 32	Summary	25, 27, 29, 31, 33
CCPR1H		RCREG	
Summary	24, 26, 28, 30, 32	Summary	26, 30, 32
CCPR1L		RCSTA	
Summary	24, 26, 28, 30, 32	Diagram	106
CCPR2H		Summary	26, 30, 32
Summary	26, 30, 32	SPBRG	
CCPR2L		Summary	27, 31, 33
Summary	26, 30, 32	SSPBUF	
FSR		Section	86
Indirect Addressing	49	Summary	24, 26, 28, 30, 32
Summary	24, 26, 28, 30, 32, 34	SPPCON	
INDF		Diagram	85
Indirect Addressing	49	Summary	24, 26, 28, 30, 32
Summary	24, 26, 28, 30, 32, 34	SSPSR	
INTCON		Section	86
Diagram	37	SSPSTAT	
Section	37	Diagram	84
Summary	24, 26, 28, 30, 32, 34	Section	84
OPTION		Summary	25, 27, 29, 31, 33
Diagram	36	STATUS	
Section	36	Diagram	35
Summary	25, 27, 29, 31, 33, 34	Section	35
PCL		Summary	24, 26, 28, 30, 32, 34
Section	48	T1CON	
Summary	24, 26, 28, 30, 32, 34	Diagram	71
PCLATH		Section	71
Section	48	Summary	24, 26, 28, 30, 32
Summary	24, 26, 28, 30, 32, 34	T2CON	
PCON		Diagram	75
Diagram	47	Section	75
Section	47	Summary	24, 26, 28, 30, 32
Summary	25, 27, 29, 31, 33	TMR0	
PIE1		Summary	24, 26, 28, 30, 32, 34
Diagram	40	TMR1H	
Section	38	Summary	24, 26, 28, 30, 32
Summary	25, 27, 29, 31, 33	TMR1L	
PIE2		Summary	24, 26, 28, 30, 32
Diagram	45	TMR2	
Section	45	Summary	24, 26, 28, 30, 32
Summary	27, 31, 33	TRISA	
PIR1		Section	51
Diagram	44	Summary	25, 27, 29, 31, 33
Section	41	TRISB	
Summary	24, 26, 28, 30, 32	Section	53
PIR2		Summary	25, 27, 29, 31, 33, 34
Diagram	46	TRISC	
Section	46	Section	55
Summary	26, 30, 32	Summary	25, 27, 29, 31, 33
PORTA		TRISD	
Section	51	Section	57
Summary	24, 26, 28, 30, 32	Summary	29, 31, 33
PORTB		TRISE	
Section	53	Diagram	58
Summary	24, 26, 28, 30, 32, 34	Section	58
PORTC		Summary	29, 31, 33
Section	55	TXREG	
Summary	24, 26, 28, 30, 32	Summary	26, 30, 32

PIC16C6X

TXSTA	
Diagram	105
Section	105
Summary	31, 33
W	9
Special Function Registers, Initialization	
Conditions	132
Special Function Registers, Reset Conditions	131
Special Function Register Summary ...	24, 26, 28, 30, 32
File Maps	21
Resets	128
ROM	7
RP0 bit	20, 35
RP1	35
RX9	106
RX9D	106
S	
S	84, 89
SCI - See Universal Synchronous Asynchronous Receiver Transmitter (USART)	
SCK	86
SCL	100
SDI	86
SDO	86
Serial Port Enable bit, SPEN	106
Serial Programming	142
Serial Programming, Block Diagram	142
Serialized Quick-Turnaround-Production	7
Single Receive Enable bit, SREN	106
Slave Mode	
SCL	100
SDA	100
SLEEP Mode	123, 141
SMP	89
Software Simulator (MPSIM)	161
SPBRG	25, 27, 29, 31, 33, 34
Special Features, Section	123
SPEN	106
SPI	
Block Diagram	86, 91
Master Mode	92
Master Mode Timing	93
Mode	86
Serial Clock	91
Serial Data In	91
Serial Data Out	91
Slave Mode Timing	94
Slave Mode Timing Diagram	93
Slave Select	91
SPI clock	92
SPI Mode	91
SSPCON	90
SSPSTAT	89
SPI Clock Edge Select bit, CKE	89
SPI Data Input Sample Phase Select bit, SMP	89
SPI Mode	86
SREN	106
SS	86
SSP	
Module Overview	83
Section	83
SSPBUF	92
SSPCON	90
SSPSR	92
SSPSTAT	89
SSP in I ² C Mode - See I ² C	
SSPADD	25, 27, 29, 31, 33, 34, 99
SSPBUF	24, 26, 28, 30, 32, 34, 99
SSPCON	24, 26, 28, 30, 32, 34, 85, 90
SSPEN	85, 90
SSPIE	38
SSPIF	41
SSPM3:SSPM0	85, 90
SSPOV	85, 90, 100
SSPSTAT	25, 27, 29, 31, 33, 34, 84, 99
SSPSTAT Register	89
Stack	48
Start bit, S	84, 89
STATUS	24, 25, 26, 27, 28, 29, 30, 31, 32, 33, 34
Status bits	130, 131
Status Bits During Various Resets	131
Stop bit, P	84, 89
Switching Prescalers	69
SYNC, USART Mode Select bit, SYNC	105
Synchronizing Clocks, TMR0	67
Synchronous Serial Port (SSP)	
Block Diagram, SPI Mode	86
SPI Master/Slave Diagram	87
SPI Mode	86
Synchronous Serial Port Enable bit, SSPEN	85, 90
Synchronous Serial Port Interrupt Enable bit, SSPIE	38
Synchronous Serial Port Interrupt Flag bit, SSPIF	41
Synchronous Serial Port Mode Select bits,	
SSPM3:SSPM0	85, 90
Synchronous Serial Port Module	83
Synchronous Serial Port Status Register	89
T	
T0CS	36
TOIE	37
TOIF	37
T0SE	36
T1CKPS1:T1CKPS0	71
T1CON	24, 26, 28, 30, 32, 34
T1OSCEN	71
T1SYNC	71
T2CKPS1:T2CKPS0	75
T2CON	24, 26, 28, 30, 32, 34, 75
Time-out	130
Time-out bit	35
Time-out Sequence	130
Timer Modules	
Overview, all	63
Timer0	
Block Diagram	65
Counter Mode	65
External Clock	67
Interrupt	65
Overview	63
Prescaler	68
Section	65
Timer Mode	65
Timing Diagram/Timing Diagrams	
Timer0	65
TMR0 register	65
Timer1	
Block Diagram	72
Capacitor Selection	73
Counter Mode, Asynchronous	73
Counter Mode, Synchronous	72
External Clock	73
Oscillator	73

Overview	63	Watchdog Timer	207
Prescaler.....	72	PIC16C63	
Read/Write in Asynchronous Counter Mode	73	Brown-out Reset.....	239
Section.....	71	Capture/Compare/PWM	241
Synchronizing with External Clock.....	72	CLKOUT and I/O	238
Timer Mode.....	72	External Clock	237
TMR1 Register Pair	71	I ² C Bus Data.....	245
Timer2		I ² C Bus Start/Stop Bits	244
Block Diagram	75	Oscillator Start-up Timer.....	239
Overview.....	63	Power-up Timer.....	239
Postscaler	75	Reset.....	239
Prescaler.....	75	SPI Mode.....	243
Timer0 Clock Synchronization, Delay	67	Timer0	240
Timer0 Interrupt	138	Timer1	240
Timer1 Clock Source Select bit, TMR1CS.....	71	USART Synchronous Receive	
Timer1 External Clock Input Synchronization		(Master/Slave)	246
Control bit, T1SYNC	71	Watchdog Timer	239
Timer1 Input Clock Prescale Select bits	71	PIC16C64	
Timer1 Mode Selection	78	Capture/Compare/PWM	193
Timer1 On bit, TMR1ON	71	CLKOUT and I/O	190
Timer1 Oscillator Enable Control bit, T1OSCN	71	External Clock	189
Timer2 Clock Prescale Select bits,		I ² C Bus Data.....	197
T2CKPS1:T2CKPS0	75	I ² C Bus Start/Stop Bits	196
Timer2 Module	75	Oscillator Start-up Timer.....	191
Timer2 On bit, TMR2ON	75	Parallel Slave Port.....	194
Timer2 Output Postscale Select bits,		Power-up Timer.....	191
TOUTPS3:TOUTPS0	75	Reset.....	191
Timing Diagrams		SPI Mode.....	195
Brown-out Reset	129	Timer0	192
I ² C Clock Synchronization	98	Timer1	192
I ² C Data Transfer Wait State	96	Watchdog Timer	191
I ² C Multi-Master Arbitration.....	98	PIC16C64A	
I ² C Reception (7-bit Address).....	101	Brown-out Reset.....	207
PIC16C61		Capture/Compare/PWM	209
CLKOUT and I/O	170	CLKOUT and I/O	206
External Clock	169	External Clock	205
Oscillator Start-up Timer.....	171	I ² C Bus Data.....	213
Power-up Timer	171	I ² C Bus Start/Stop Bits	212
Reset	171	Oscillator Start-up Timer.....	207
Timer0.....	172	Parallel Slave Port.....	210
Watchdog Timer	171	Power-up Timer.....	207
PIC16C62		Reset.....	207
Capture/Compare/PWM	193	SPI Mode.....	211
CLKOUT and I/O	190	Timer0	208
External Clock	189	Timer1	208
I ² C Bus Data	197	Watchdog Timer	207
I ² C Bus Start/Stop Bits	196	PIC16C65	
Oscillator Start-up Timer.....	191	Capture/Compare/PWM	225
Power-up Timer	191	CLKOUT and I/O	222
Reset	191	External Clock	221
SPI Mode	195	I ² C Bus Data.....	229
Timer0.....	192	I ² C Bus Start/Stop Bits	228
Timer1.....	192	Oscillator Start-up Timer.....	223
Watchdog Timer	191	Parallel Slave Port.....	226
PIC16C62A		Reset	223
Brown-out Reset	207	SPI Mode.....	227
Capture/Compare/PWM	209	Timer0	224
CLKOUT and I/O	206	Timer1	224
External Clock	205	USART Synchronous Receive	
I ² C Bus Data.....	213	(Master/Slave)	230
I ² C Bus Start/Stop Bits	212	Watchdog Timer	223
Oscillator Start-up Timer.....	207	PIC16C65A	
Power-up Timer	207	Brown-out Reset.....	239
Reset	207	Capture/Compare/PWM	241
SPI Mode	211	CLKOUT and I/O	238
Timer0.....	208	External Clock	237
Timer1.....	208	I ² C Bus Data.....	245

PIC16C6X

I ² C Bus Start/Stop Bits.....	244	PIC16CR63	
Oscillator Start-up Timer.....	239	Brown-out Reset.....	255
Parallel Slave Port	242	Capture/Compare/PWM	257
Power-up Timer	239	CLKOUT and I/O	254
Reset.....	239	External Clock	253
SPI Mode	243	I ² C Bus Data.....	261
Timer0.....	240	I ² C Bus Start/Stop Bits	260
Timer1.....	240	Oscillator Start-up Timer.....	255
USART Synchronous Receive		Power-up Timer	255
(Master/Slave).....	246	Reset	255
Watchdog Timer.....	239	SPI Mode	259
PIC16C66		Timer0	256
Brown-out Reset	271	Timer1	256
Capture/Compare/PWM.....	273	USART Synchronous Receive	
CLKOUT and I/O.....	270	(Master/Slave)	262
External Clock.....	269	Watchdog Timer	255
I ² C Bus Data.....	279	PIC16CR64	
I ² C Bus Start/Stop Bits.....	278	Capture/Compare/PWM	209
Oscillator Start-up Timer.....	271	CLKOUT and I/O	206
Power-up Timer	271	External Clock	205
Reset.....	271	I ² C Bus Data.....	213
Timer0.....	272	I ² C Bus Start/Stop Bits	212
Timer1.....	272	Oscillator Start-up Timer.....	207
USART Synchronous Receive		Parallel Slave Port	210
(Master/Slave).....	280	Power-up Timer	207
Watchdog Timer.....	271	Reset	207
PIC16C67		SPI Mode	211
Brown-out Reset	271	Timer0	208
Capture/Compare/PWM.....	273	Timer1	208
CLKOUT and I/O.....	270	Watchdog Timer	207
External Clock.....	269	PIC16CR65	
I ² C Bus Data.....	279	Brown-out Reset.....	255
I ² C Bus Start/Stop Bits.....	278	Capture/Compare/PWM	257
Oscillator Start-up Timer.....	271	CLKOUT and I/O	254
Parallel Slave Port	274	External Clock	253
Power-up Timer	271	I ² C Bus Data.....	261
Reset.....	271	I ² C Bus Start/Stop Bits	260
Timer0.....	272	Oscillator Start-up Timer.....	255
Timer1.....	272	Parallel Slave Port	258
USART Synchronous Receive		Power-up Timer	255
(Master/Slave).....	280	Reset	255
Watchdog Timer.....	271	SPI Mode.....	259
PIC16CR62		Timer0	256
Capture/Compare/PWM.....	209	Timer1	256
CLKOUT and I/O.....	206	USART Synchronous Receive	
External Clock.....	205	(Master/Slave)	262
I ² C Bus Data.....	213	Watchdog Timer	255
I ² C Bus Start/Stop Bits.....	212	Power-up Timer.....	223
Oscillator Start-up Timer.....	207	PWM Output	80
Power-up Timer	207	RB0/INT Interrupt.....	138
Reset.....	207	RX Pin Sampling.....	110, 111
SPI Mode	211	SPI Master Mode	93
Timer0.....	208	SPI Mode, Master/Slave Mode,	
Timer1.....	208	No \overline{SS} Control.....	88
Watchdog Timer.....	207	SPI Mode, Slave Mode With \overline{SS} Control	88
		SPI Slave Mode (CKE = 1)	94
		SPI Slave Mode Timing (CKE = 0)	93
		Timer0 with External Clock	67
		TMR0 Interrupt Timing.....	66
		USART Asynchronous Master Transmission	113
		USART Asynchronous Master Transmission	
		(Back to Back)	113
		USART Asynchronous Reception.....	114
		USART Synchronous Reception in	
		Master Mode.....	119
		USART Synchronous Transmission.....	117
		Wake-up from SLEEP Through Interrupts	142

TMR0	24, 26, 28, 30, 32, 34
TMR0 Clock Source Select bit, TOCS	36
TMR0 Interrupt	65
TMR0 Overflow Interrupt Enable bit, T0IE	37
TMR0 Overflow Interrupt Flag bit, T0IF	37
TMR0 Prescale Selection Table	36
TMR0 Source Edge Select bit, T0SE	36
TMR1 Overflow Interrupt Enable bit, TMR1IE	38
TMR1 Overflow Interrupt Flag bit, TMR1IF	41
TMR1CS	71
TMR1H	24, 26, 28, 30, 32, 34
TMR1IE	38
TMR1IF	41
TMR1L	24, 26, 28, 30, 32, 34
TMR1ON	71
TMR2	24, 26, 28, 30, 32, 34
TMR2 Register	75
TMR2 to PR2 Match Interrupt Enable bit, TMR2IE	38
TMR2 to PR2 Match Interrupt Flag bit, TMR2IF	41
TMR2IE	38
TMR2IF	41
TMR2ON	75
TO	35, 131
TOUPTS3:TOUTPS0	75
Transmit Enable bit, TXEN	105
Transmit Shift Register Status bit, TRMT	105
Transmit Status and Control Register	105
TRISA	25, 27, 29, 31, 33, 34, 51
TRISB	25, 27, 29, 31, 33, 34, 53
TRISC	25, 27, 29, 31, 33, 34, 55, 94
TRISD	25, 27, 29, 31, 33, 34, 57
TRISE	25, 27, 29, 31, 33, 34, 58
TRMT	105
TX9	105
TX9D	105
TXEN	105
TXIE	39
TXIF	42
TXREG	24, 26, 28, 30, 32, 34
TXSTA	25, 27, 29, 31, 33, 34, 105

U

UA	84, 89
Universal Synchronous Asynchronous Receiver Transmitter (USART)	
Asynchronous Mode	
Setting Up Transmission	113
Timing Diagram, Master Transmission	113
Transmitter	112
Asynchronous Receiver	
Setting Up Reception	115
Timing Diagram	114
Asynchronous Receiver Mode	
Block Diagram	114
Section	114
Section	105
Synchronous Master Mode	
Reception	118
Section	116
Setting Up Reception	118
Setting Up Transmission	116
Timing Diagram, Reception	119
Timing Diagram, Transmission	117
Transmission	116

Synchronous Slave Mode

Reception	120
Section	120
Setting Up Reception	120
Setting Up Transmission	120
Transmit	120
Transmit Block Diagram	112
Update Address bit, UA	84, 89
USART Receive Interrupt Enable bit, RCIE	39
USART Receive Interrupt Flag bit, RCIF	42
USART Transmit Interrupt Enable bit, TXIE	39
USART Transmit Interrupt Flag bit, TXIF	42
UV Erasable Devices	7

W

Wake-up from Sleep	141
Wake-up on Key Depression	53
Wake-up Using Interrupts	141
Watchdog Timer (WDT)	
Block Diagram	140
Period	140
Programming Considerations	140
Section	140
WCOL	85, 90
Weak Internal Pull-ups	53
Write Collision Detect bit, WCOL	85, 90

X

XMIT_MODE	104
XT	130

Z

Z	35
Zero bit	9, 35

PIC16C6X

LIST OF EQUATION AND EXAMPLES

Example 3-1: Instruction Pipeline Flow	18
Example 4-1: Call of a Subroutine in Page 1 from Page 0	49
Example 4-2: Indirect Addressing	49
Example 5-1: Initializing PORTA	51
Example 5-2: Initializing PORTB	53
Example 5-3: Initializing PORTC	55
Example 5-4: Read-Modify-Write Instructions on an I/O Port	60
Example 7-1: Changing Prescaler (Timer0→WDT)	69
Example 7-2: Changing Prescaler (WDT→Timer0)	69
Example 8-1: Reading a 16-bit Free-running Timer	73
Example 10-1: Changing Between Capture Prescalers	79
Example 10-2: PWM Period and Duty Cycle Calculation	81
Example 11-1: Loading the SSPBUF (SSPSR) Register	86
Example 11-2: Loading the SSPBUF (SSPSR) Register (PIC16C66/67)	91
Example 12-1: Calculating Baud Rate Error	107
Example 13-1: Saving Status and W Registers in RAM	139
Example 13-2: Saving Status, W, and PCLATH Registers in RAM (All other PIC16C6X devices)	139

LIST OF FIGURES

Figure 3-1: PIC16C61 Block Diagram	10
Figure 3-2: PIC16C62/62A/R62/64/64A/R64 Block Diagram	11
Figure 3-3: PIC16C63/R63/65/65A/R65 Block Diagram	12
Figure 3-4: PIC16C66/67 Block Diagram	13
Figure 3-5: Clock/Instruction Cycle	18
Figure 4-1: PIC16C61 Program Memory Map and Stack	19
Figure 4-2: PIC16C62/62A/R62/64/64A/ R64 Program Memory Map and Stack	19
Figure 4-3: PIC16C63/R63/65/65A/R65 Program Memory Map and Stack	19
Figure 4-4: PIC16C66/67 Program Memory Map and Stack	20
Figure 4-5: PIC16C61 Register File Map	20
Figure 4-6: PIC16C62/62A/R62/64/64A/ R64 Register File Map	21
Figure 4-7: PIC16C63/R63/65/65A/R65 Register File Map	21
Figure 4-8: PIC16C66/67 Data Memory Map	22
Figure 4-9: STATUS Register (Address 03h, 83h, 103h, 183h)	35
Figure 4-10: OPTION Register (Address 81h, 181h)	36
Figure 4-11: INTCON Register (Address 0Bh, 8Bh, 10Bh, 18Bh)	37
Figure 4-12: PIE1 Register for PIC16C62/62A/R62 (Address 8Ch)	38
Figure 4-13: PIE1 Register for PIC16C63/R63/66 (Address 8Ch)	39
Figure 4-14: PIE1 Register for PIC16C64/64A/R64 (Address 8Ch)	39

Figure 4-15: PIE1 Register for PIC16C65/65A/R65/67 (Address 8Ch)	40
Figure 4-16: PIR1 Register for PIC16C62/62A/R62 (Address 0Ch)	41
Figure 4-17: PIR1 Register for PIC16C63/R63/66 Address 0Ch	42
Figure 4-18: PIR1 Register for PIC16C64/64A/R64 (Address 0Ch)	43
Figure 4-19: PIR1 Register for PIC16C65/65A/R65/67 (Address 0Ch)	44
Figure 4-20: PIE2 Register (Address 8Dh)	45
Figure 4-21: PIR2 Register (Address 0Dh)	46
Figure 4-22: PCON Register for PIC16C62/64/65 (Address 8Eh)	47
Figure 4-23: PCON Register for PIC16C62A/R62/63/ R63/64A/R64/65A/R65/66/67 (Address 8Eh)	47
Figure 4-24: Loading of PC in Different Situations	48
Figure 4-25: Direct/Indirect Addressing	49
Figure 5-1: Block Diagram of the RA3:RA0 Pins and the RA5 Pin	51
Figure 5-2: Block Diagram of the RA4/T0CKI Pin	51
Figure 5-3: Block Diagram of the RB7:RB4 Pins for PIC16C61/62/64/65	53
Figure 5-4: Block Diagram of the RB7:RB4 Pins for PIC16C62A/63/R63/ 64A/65A/R65/66/67	54
Figure 5-5: Block Diagram of the RB3:RB0 Pins	54
Figure 5-6: PORTC Block Diagram	55
Figure 5-7: PORTD Block Diagram (In I/O Port Mode)	57
Figure 5-8: PORTE Block Diagram (In I/O Port Mode)	58
Figure 5-9: TRISE Register (Address 89h)	58
Figure 5-10: Successive I/O Operation	60
Figure 5-11: PORTD and PORTE as a Parallel Slave Port	61
Figure 5-12: Parallel Slave Port Write Waveforms	62
Figure 5-13: Parallel Slave Port Read Waveforms	62
Figure 7-1: Timer0 Block Diagram	65
Figure 7-2: Timer0 Timing: Internal Clock/No Prescaler	65
Figure 7-3: Timer0 Timing: Internal Clock/Prescale 1:2	66
Figure 7-4: TMR0 Interrupt Timing	66
Figure 7-5: Timer0 Timing With External Clock	67
Figure 7-6: Block Diagram of the Timer0/WDT Prescaler	68
Figure 8-1: T1CON: Timer1 Control Register (Address 10h)	71
Figure 8-2: Timer1 Block Diagram	72
Figure 9-1: Timer2 Block Diagram	75
Figure 9-2: T2CON: Timer2 Control Register (Address 12h)	75
Figure 10-1: CCP1CON Register (Address 17h) / CCP2CON Register (Address 1Dh)	78
Figure 10-2: Capture Mode Operation Block Diagram	78
Figure 10-3: Compare Mode Operation Block Diagram	79
Figure 10-4: Simplified PWM Block Diagram	80
Figure 10-5: PWM Output	80
Figure 11-1: SSPSTAT: Sync Serial Port Status Register (Address 94h)	84

Figure 11-2:	SSPCON: Sync Serial Port Control Register (Address 14h)	85	Figure 13-2:	Configuration Word for PIC16C62/64/65	124
Figure 11-3:	SSP Block Diagram (SPI Mode)	86	Figure 13-3:	Configuration Word for PIC16C62A/R62/63/R63/64A/R64/65A/R65/66/67	124
Figure 11-4:	SPI Master/Slave Connection	87	Figure 13-4:	Crystal/Ceramic Resonator Operation (HS, XT or LP OSC Configuration)	125
Figure 11-5:	SPI Mode Timing, Master Mode or Slave Mode w/o \overline{SS} Control	88	Figure 13-5:	External Clock Input Operation (HS, XT or LP OSC Configuration)	125
Figure 11-6:	SPI Mode Timing, Slave Mode with \overline{SS} Control	88	Figure 13-6:	External Parallel Resonant Crystal Oscillator Circuit	127
Figure 11-7:	SSPSTAT: Sync Serial Port Status Register (Address 94h)(PIC16C66/67)	89	Figure 13-7:	External Series Resonant Crystal Oscillator Circuit	127
Figure 11-8:	SSPCON: Sync Serial Port Control Register (Address 14h)(PIC16C66/67)	90	Figure 13-8:	RC Oscillator Mode	127
Figure 11-9:	SSP Block Diagram (SPI Mode) (PIC16C66/67)	91	Figure 13-9:	Simplified Block Diagram of On-chip Reset Circuit	128
Figure 11-10:	SPI Master/Slave Connection (PIC16C66/67)	92	Figure 13-10:	Brown-out Situations	129
Figure 11-11:	SPI Mode Timing, Master Mode (PIC16C66/67)	93	Figure 13-11:	Time-out Sequence on Power-up (MCLR Not Tied to VDD): Case 1	134
Figure 11-12:	SPI Mode Timing (Slave Mode With CKE = 0) (PIC16C66/67)	93	Figure 13-12:	Time-out Sequence on Power-up (MCLR Not Tied To VDD): Case 2	134
Figure 11-13:	SPI Mode Timing (Slave Mode With CKE = 1) (PIC16C66/67)	94	Figure 13-13:	Time-out Sequence on Power-up (MCLR Tied to VDD)	134
Figure 11-14:	Start and Stop Conditions	95	Figure 13-14:	External Power-on Reset Circuit (For Slow VDD Power-up)	135
Figure 11-15:	7-bit Address Format	96	Figure 13-15:	External Brown-out Protection Circuit 1	135
Figure 11-16:	I ² C 10-bit Address Format	96	Figure 13-16:	External Brown-out Protection Circuit 2	135
Figure 11-17:	Slave-receiver Acknowledge	96	Figure 13-17:	Interrupt Logic for PIC16C61	137
Figure 11-18:	Data Transfer Wait State	96	Figure 13-18:	Interrupt Logic for PIC16C6X	137
Figure 11-19:	Master-transmitter Sequence	97	Figure 13-19:	INT Pin Interrupt Timing	138
Figure 11-20:	Master-receiver Sequence	97	Figure 13-20:	Watchdog Timer Block Diagram	140
Figure 11-21:	Combined Format	97	Figure 13-21:	Summary of Watchdog Timer Registers	140
Figure 11-22:	Multi-master Arbitration (Two Masters)	98	Figure 13-22:	Wake-up from Sleep Through Interrupt	142
Figure 11-23:	Clock Synchronization	98	Figure 13-23:	Typical In-circuit Serial Programming Connection	142
Figure 11-24:	SSP Block Diagram (I ² C Mode)	99	Figure 14-1:	General Format for Instructions	143
Figure 11-25:	I ² C Waveforms for Reception (7-bit Address)	101	Figure 16-1:	Load Conditions for Device Timing Specifications	168
Figure 11-26:	I ² C Waveforms for Transmission (7-bit Address)	102	Figure 16-2:	External Clock Timing	169
Figure 11-27:	Operation of the I ² C Module in IDLE_MODE, RCV_MODE or XMIT_MODE	104	Figure 16-3:	CLKOUT and I/O Timing	170
Figure 12-1:	TXSTA: Transmit Status and Control Register (Address 98h)	105	Figure 16-4:	Reset, Watchdog Timer, Oscillator Start-up Timer and Power-up Timer Timing	171
Figure 12-2:	RCSTA: Receive Status and Control Register (Address 18h)	106	Figure 16-5:	Timer0 External Clock Timings	172
Figure 12-3:	RX Pin Sampling Scheme (BRGH = 0) (PIC16C63/R63/65/65A/R65)	110	Figure 17-1:	Typical RC Oscillator Frequency vs. Temperature	173
Figure 12-4:	RX Pin Sampling Scheme (BRGH = 1) (PIC16C63/R63/65/65A/R65)	110	Figure 17-2:	Typical RC Oscillator Frequency vs. VDD	174
Figure 12-5:	RX Pin Sampling Scheme (BRGH = 1) (PIC16C63/R63/65/65A/R65)	110	Figure 17-3:	Typical RC Oscillator Frequency vs. VDD	174
Figure 12-6:	RX Pin Sampling Scheme (BRGH = 0 or = 1) (PIC16C66/67)	111	Figure 17-4:	Typical RC Oscillator Frequency vs. VDD	174
Figure 12-7:	USART Transmit Block Diagram	112	Figure 17-5:	Typical IPD vs. VDD Watchdog Timer Disabled 25°C	174
Figure 12-8:	Asynchronous Master Transmission	113	Figure 17-6:	Typical IPD vs. VDD Watchdog Timer Enabled 25°C	175
Figure 12-9:	Asynchronous Master Transmission (Back to Back)	113	Figure 17-7:	Maximum IPD vs. VDD Watchdog Disabled	175
Figure 12-10:	USART Receive Block Diagram	114	Figure 17-8:	Maximum IPD vs. VDD Watchdog Enabled*	176
Figure 12-11:	Asynchronous Reception	114	Figure 17-9:	VTH (Input Threshold Voltage) of I/O Pins vs. VDD	176
Figure 12-12:	Synchronous Transmission	117			
Figure 12-13:	Synchronous Transmission through TXEN	117			
Figure 12-14:	Synchronous Reception (Master Mode, SREN)	119			
Figure 13-1:	Configuration Word for PIC16C61	123			

PIC16C6X

Figure 17-10: VIH, VIL of \overline{MCLR} , T0CKI and OSC1 (in RC Mode) vs. VDD	177	Figure 20-7: Parallel Slave Port Timing	226
Figure 17-11: VTH (Input Threshold Voltage) of OSC1 Input (in XT, HS, and LP Modes) vs. VDD	177	Figure 20-8: SPI Mode Timing	227
Figure 17-12: Typical IDD vs. Frequency (External Clock, 25°C)	178	Figure 20-9: I ² C Bus Start/Stop Bits Timing	228
Figure 17-13: Maximum IDD vs. Frequency (External Clock, -40° to +85°C).....	178	Figure 20-10: I ² C Bus Data Timing.....	229
Figure 17-14: Maximum IDD vs. Frequency (External Clock, -55° to +125°C).....	179	Figure 20-11: USART Synchronous Transmission (Master/Slave) Timing	230
Figure 17-15: WDT Timer Time-out Period vs. VDD	179	Figure 20-12: USART Synchronous Receive (Master/Slave) Timing	230
Figure 17-16: Transconductance (gm) of HS Oscillator vs. VDD.....	179	Figure 21-1: Load Conditions for Device Timing Specifications	236
Figure 17-17: Transconductance (gm) of LP Oscillator vs. VDD.....	180	Figure 21-2: External Clock Timing.....	237
Figure 17-18: Transconductance (gm) of XT Oscillator vs. VDD.....	180	Figure 21-3: CLKOUT and I/O Timing	238
Figure 17-19: IOH vs. VOH, VDD = 3V	180	Figure 21-4: Reset, Watchdog Timer, Oscillator Start-up Timer and Power-up Timer Timing.....	239
Figure 17-20: IOH vs. VOH, VDD = 5V	180	Figure 21-5: Brown-out Reset Timing	239
Figure 17-21: IOL vs. VOL, VDD = 3V	181	Figure 21-6: Timer0 and Timer1 External Clock Timings	240
Figure 17-22: IOL vs. VOL, VDD = 5V	181	Figure 21-7: Capture/Compare/PWM Timings (CCP1 and CCP2)	241
Figure 18-1: Load Conditions for Device Timing Specifications	188	Figure 21-8: Parallel Slave Port Timing (PIC16C65A)	242
Figure 18-2: External Clock Timing	189	Figure 21-9: SPI Mode Timing	243
Figure 18-3: CLKOUT and I/O Timing.....	190	Figure 21-10: I ² C Bus Start/Stop Bits Timing	244
Figure 18-4: Reset, Watchdog Timer, Oscillator Start-up Timer and Power-up Timer Timing	191	Figure 21-11: I ² C Bus Data Timing.....	245
Figure 18-5: Timer0 and Timer1 External Clock Timings	192	Figure 21-12: USART Synchronous Transmission (Master/Slave) Timing	246
Figure 18-6: Capture/Compare/PWM Timings (CCP1)	193	Figure 21-13: USART Synchronous Receive (Master/Slave) Timing	246
Figure 18-7: Parallel Slave Port Timing (PIC16C64)	194	Figure 22-1: Load Conditions for Device Timing Specifications	252
Figure 18-8: SPI Mode Timing	195	Figure 22-2: External Clock Timing.....	253
Figure 18-9: I ² C Bus Start/Stop Bits Timing.....	196	Figure 22-3: CLKOUT and I/O Timing	254
Figure 18-10: I ² C Bus Data Timing	197	Figure 22-4: Reset, Watchdog Timer, Oscillator Start-up Timer and Power-up Timer Timing	255
Figure 19-1: Load Conditions for Device Timing Specifications	204	Figure 22-5: Brown-out Reset Timing.....	255
Figure 19-2: External Clock Timing.....	205	Figure 22-6: Timer0 and Timer1 External Clock Timings	256
Figure 19-3: CLKOUT and I/O Timing.....	206	Figure 22-7: Capture/Compare/PWM Timings (CCP1 and CCP2).....	257
Figure 19-4: Reset, Watchdog Timer, Oscillator Start-up Timer and Power-up Timer Timing	207	Figure 22-8: Parallel Slave Port Timing (PIC16CR65)	258
Figure 19-5: Brown-out Reset Timing	207	Figure 22-9: SPI Mode Timing	259
Figure 19-6: Timer0 and Timer1 External Clock Timings	208	Figure 22-10: I ² C Bus Start/Stop Bits Timing	260
Figure 19-7: Capture/Compare/PWM Timings (CCP1)	209	Figure 22-11: I ² C Bus Data Timing.....	261
Figure 19-8: Parallel Slave Port Timing (PIC16C64A/R64)	210	Figure 22-12: USART Synchronous Transmission (Master/Slave) Timing	262
Figure 19-9: SPI Mode Timing	211	Figure 22-13: USART Synchronous Receive (Master/Slave) Timing	262
Figure 19-10: I ² C Bus Start/Stop Bits Timing.....	212	Figure 23-1: Load Conditions for Device Timing Specifications	268
Figure 19-11: I ² C Bus Data Timing	213	Figure 23-2: External Clock Timing.....	269
Figure 20-1: Load Conditions for Device Timing Specifications.....	220	Figure 23-3: CLKOUT and I/O Timing	270
Figure 20-2: External Clock Timing.....	221	Figure 23-4: Reset, Watchdog Timer, Oscillator Start-up Timer and Power-up Timer Timing	271
Figure 20-3: CLKOUT and I/O Timing.....	222	Figure 23-5: Brown-out Reset Timing.....	271
Figure 20-4: Reset, Watchdog Timer, Oscillator Start-up Timer and Power-up Timer Timing	223	Figure 23-6: Timer0 and Timer1 External Clock Timings	272
Figure 20-5: Timer0 and Timer1 External Clock Timings	224	Figure 23-7: Capture/Compare/PWM Timings (CCP1 and CCP2).....	273
Figure 20-6: Capture/Compare/PWM Timings (CCP1 and CCP2)	225	Figure 23-8: Parallel Slave Port Timing (PIC16C67)	274
		Figure 23-9: SPI Master Mode Timing (CKE = 0)	275
		Figure 23-10: SPI Master Mode Timing (CKE = 1)	275
		Figure 23-11: SPI Slave Mode Timing (CKE = 0)	276

Figure 23-12: SPI Slave Mode Timing (CKE = 1)	276	Figure 24-29: Typical IDD vs. Frequency (HS Mode, 25°C).....	290
Figure 23-13: I ² C Bus Start/Stop Bits Timing.....	278	Figure 24-30: Maximum IDD vs. Frequency (HS Mode, -40°C to 85°C).....	290
Figure 23-14: I ² C Bus Data Timing	279		
Figure 23-15: USART Synchronous Transmission (Master/Slave) Timing.....	280		
Figure 23-16: USART Synchronous Receive (Master/Slave) Timing.....	280		
Figure 24-1: Typical IPD vs. VDD (WDT Disabled, RC Mode).....	281		
Figure 24-2: Maximum IPD vs. VDD (WDT Disabled, RC Mode).....	281		
Figure 24-3: Typical IPD vs. VDD @ 25°C (WDT Enabled, RC Mode).....	282		
Figure 24-4: Maximum IPD vs. VDD (WDT Enabled, RC Mode).....	282		
Figure 24-5: Typical RC Oscillator Frequency vs. VDD.....	282		
Figure 24-6: Typical RC Oscillator Frequency vs. VDD.....	282		
Figure 24-7: Typical RC Oscillator Frequency vs. VDD.....	282		
Figure 24-8: Typical IPD vs. VDD Brown-out Detect Enabled (RC Mode).....	283		
Figure 24-9: Maximum IPD vs. VDD Brown-out Detect Enabled (85°C to -40°C, RC Mode).....	283		
Figure 24-10: Typical IPD vs. Timer1 Enabled (32 kHz, RC0/RC1 = 33 pF/33 pF, RC Mode)	283		
Figure 24-11: Maximum IPD vs. Timer1 Enabled (32 kHz, RC0/RC1 = 33 pF/33 pF, 85°C to -40°C, RC Mode)	283		
Figure 24-12: Typical IDD vs. Frequency (RC Mode @ 22 pF, 25°C)	284		
Figure 24-13: Maximum IDD vs. Frequency (RC Mode @ 22 pF, -40°C to 85°C).....	284		
Figure 24-14: Typical IDD vs. Frequency (RC Mode @ 100 pF, 25°C)	285		
Figure 24-15: Maximum IDD vs. Frequency (RC Mode @ 100 pF, -40°C to 85°C)	285		
Figure 24-16: Typical IDD vs. Frequency (RC Mode @ 300 pF, 25°C)	286		
Figure 24-17: Maximum IDD vs. Frequency (RC Mode @ 300 pF, -40°C to 85°C).....	286		
Figure 24-18: Typical IDD vs. Capacitance @ 500 kHz (RC Mode)	287		
Figure 24-19: Transconductance(gm) of HS Oscillator vs. VDD.....	287		
Figure 24-20: Transconductance(gm) of LP Oscillator vs. VDD.....	287		
Figure 24-21: Transconductance(gm) of XT Oscillator vs. VDD.....	287		
Figure 24-22: Typical XTAL Startup Time vs. VDD (LP Mode, 25°C)	288		
Figure 24-23: Typical XTAL Startup Time vs. VDD (HS Mode, 25°C)	288		
Figure 24-24: Typical XTAL Startup Time vs. VDD (XT Mode, 25°C).....	288		
Figure 24-25: Typical Idd vs. Frequency (LP Mode, 25°C).....	289		
Figure 24-26: Maximum IDD vs. Frequency (LP Mode, 85°C to -40°C).....	289		
Figure 24-27: Typical IDD vs. Frequency (XT Mode, 25°C).....	289		
Figure 24-28: Maximum IDD vs. Frequency (XT Mode, -40°C to 85°C).....	289		

PIC16C6X

LIST OF TABLES

Table 1-1:	PIC16C6X Family of Devices	6	Table 12-2:	Registers Associated with Baud Rate Generator.....	107
Table 3-1:	PIC16C61 Pinout Description	14	Table 12-3:	Baud Rates for Synchronous Mode.....	108
Table 3-2:	PIC16C62/62A/R62/63/R63/66 Pinout Description.....	15	Table 12-4:	Baud Rates for Asynchronous Mode (BRGH = 0).....	108
Table 3-3:	PIC16C64/64A/R64/65/65A/R65/67 Pinout Description.....	16	Table 12-5:	Baud Rates for Asynchronous Mode (BRGH = 1).....	109
Table 4-1:	Special Function Registers for the PIC16C61	23	Table 12-6:	Registers Associated with Asynchronous Transmission	113
Table 4-2:	Special Function Registers for the PIC16C62/62A/R62	24	Table 12-7:	Registers Associated with Asynchronous Reception.....	115
Table 4-3:	Special Function Registers for the PIC16C63/R63.....	26	Table 12-8:	Registers Associated with Synchronous Master Transmission.....	117
Table 4-4:	Special Function Registers for the PIC16C64/64A/R64	28	Table 12-9:	Registers Associated with Synchronous Master Reception	118
Table 4-5:	Special Function Registers for the PIC16C65/65A/R65	30	Table 12-10:	Registers Associated with Synchronous Slave Transmission	121
Table 4-6:	Special Function Registers for the PIC16C66/67	32	Table 12-11:	Registers Associated with Synchronous Slave Reception	121
Table 5-1:	PORTA Functions	52	Table 13-1:	Ceramic Resonators PIC16C61	126
Table 5-2:	Registers/Bits Associated with PORTA	52	Table 13-2:	Ceramic Resonators PIC16C62/62A/R62/63/R63/ 64/64A/R64/65/65A/R65/66/67	126
Table 5-3:	PORTB Functions	54	Table 13-3:	Capacitor Selection for Crystal Oscillator for PIC16C61	126
Table 5-4:	Summary of Registers Associated with PORTB	54	Table 13-4:	Capacitor Selection for Crystal Oscillator for PIC16C62/62A/R62/63/R63/ 64/64A/R64/65/65A/R65/66/67	126
Table 5-5:	PORTC Functions for PIC16C62/64	55	Table 13-5:	Time-out in Various Situations, PIC16C61/62/64/65.....	130
Table 5-6:	PORTC Functions for PIC16C62A/R62/64A/R64	56	Table 13-6:	Time-out in Various Situations, PIC16C62A/R62/63/R63/ 64A/R64/65A/R65/66/67	130
Table 5-7:	PORTC Functions for PIC16C63/R63/65/65A/R65/66/67.....	56	Table 13-7:	Status Bits and Their Significance, PIC16C61	130
Table 5-8:	Summary of Registers Associated with PORTC	56	Table 13-8:	Status bits and Their Significance, PIC16C62/64/65	130
Table 5-9:	PORTD Functions.....	57	Table 13-9:	Status Bits and Their Significance for PIC16C62A/R62/63/R63/ 64A/R64/65A/R65/66/67	131
Table 5-10:	Summary of Registers Associated with PORTD	57	Table 13-10:	Reset Condition for Special Registers on PIC16C61/62/64/65.....	131
Table 5-11:	PORTE Functions	59	Table 13-11:	Reset Condition for Special Registers on PIC16C62A/R62/63/R63/ 64A/R64/65A/R65/66/67	131
Table 5-12:	Summary of Registers Associated with PORTE	59	Table 13-12:	Initialization Conditions for all Registers.....	132
Table 5-13:	Registers Associated with Parallel Slave Port	62	Table 14-1:	Opcode Field Descriptions	143
Table 7-1:	Registers Associated with Timer0	69	Table 14-2:	PIC16CXX Instruction Set	144
Table 8-1:	Capacitor Selection for the Timer1 Oscillator.....	73	Table 15-1:	Development Tools from Microchip.....	162
Table 8-2:	Registers Associated with Timer1 as a Timer/Counter	74	Table 16-1:	Cross Reference of Device Specs for Oscillator Configurations and Frequencies of Operation (Commercial Devices).....	163
Table 9-1:	Registers Associated with Timer2 as a Timer/Counter.....	76	Table 16-2:	External Clock Timing Requirements	169
Table 10-1:	CCP Mode - Timer Resource	77	Table 16-3:	CLKOUT and I/O Timing Requirements	170
Table 10-2:	Interaction of Two CCP Modules	77	Table 16-4:	Reset, Watchdog Timer, Oscillator Start-up Timer and Power-up Timer Requirements.....	171
Table 10-3:	Example PWM Frequencies and Resolutions at 20 MHz.....	81	Table 16-5:	Timer0 External Clock Requirements.....	172
Table 10-4:	Registers Associated with Timer1, Capture and Compare	81	Table 17-1:	RC Oscillator Frequencies.....	173
Table 10-5:	Registers Associated with PWM and Timer2.....	82	Table 17-2:	Input Capacitance*	181
Table 11-1:	Registers Associated with SPI Operation	88			
Table 11-2:	Registers Associated with SPI Operation (PIC16C66/67)	94			
Table 11-3:	I ² C Bus Terminology.....	95			
Table 11-4:	Data Transfer Received Byte Actions	100			
Table 11-5:	Registers Associated with I ² C Operation	103			
Table 12-1:	Baud Rate Formula.....	107			

Table 18-1: Cross Reference of Device Specs for Oscillator Configurations and Frequencies of Operation (Commercial Devices)	183	Table 20-12: USART Synchronous Receive Requirements	230
Table 18-2: External Clock Timing Requirements	189	Table 21-1: Cross Reference of Device Specs for Oscillator Configurations and Frequencies of Operation (Commercial Devices)	231
Table 18-3: CLKOUT and I/O Timing Requirements	190	Table 21-2: External Clock Timing Requirements	237
Table 18-4: Reset, Watchdog Timer, Oscillator Start-up Timer and Power-up Timer Requirements	191	Table 21-3: CLKOUT and I/O Timing Requirements	238
Table 18-5: Timer0 and Timer1 External Clock Requirements	192	Table 21-4: Reset, Watchdog Timer, Oscillator Start-up Timer, Power-up Timer, and Brown-out Reset Requirements	239
Table 18-6: Capture/Compare/PWM Requirements (CCP1)	193	Table 21-5: Timer0 and Timer1 External Clock Requirements	240
Table 18-7: Parallel Slave Port Requirements (PIC16C64) 194		Table 21-6: Capture/Compare/PWM Requirements (CCP1 and CCP2)	241
Table 18-8: SPI Mode Requirements	195	Table 21-7: Parallel Slave Port Requirements (PIC16C65A)	242
Table 18-9: I ² C Bus Start/Stop Bits Requirements	196	Table 21-8: SPI Mode Requirements	243
Table 18-10: I ² C Bus Data Requirements	197	Table 21-9: I ² C Bus Start/Stop Bits Requirements	244
Table 19-1: Cross Reference of Device Specs for Oscillator Configurations and Frequencies of Operation (Commercial Devices)	199	Table 21-10: I ² C Bus Data Requirements	245
Table 19-2: External Clock Timing Requirements	205	Table 21-11: USART Synchronous Transmission Requirements	246
Table 19-3: CLKOUT and I/O Timing Requirements	206	Table 21-12: USART Synchronous Receive Requirements	246
Table 19-4: Reset, Watchdog Timer, Oscillator Start-up Timer, Power-up Timer, and Brown-out Reset Requirements	207	Table 22-1: Cross Reference of Device Specs for Oscillator Configurations and Frequencies of Operation (Commercial Devices)	247
Table 19-5: Timer0 and Timer1 External Clock Requirements	208	Table 22-2: External Clock Timing Requirements	253
Table 19-6: Capture/Compare/PWM Requirements (CCP1)	209	Table 22-3: CLKOUT and I/O Timing Requirements	254
Table 19-7: Parallel Slave Port Requirements (PIC16C64A/R64)	210	Table 22-4: Reset, Watchdog Timer, Oscillator Start-up Timer, Power-up Timer, and Brown-out Reset Requirements	255
Table 19-8: SPI Mode Requirements	211	Table 22-5: Timer0 and Timer1 External Clock Requirements	256
Table 19-9: I ² C Bus Start/Stop Bits Requirements	212	Table 22-6: Capture/Compare/PWM Requirements (CCP1 and CCP2)	257
Table 19-10: I ² C Bus Data Requirements	213	Table 22-7: Parallel Slave Port Requirements (PIC16CR65)	258
Table 20-1: Cross Reference of Device Specs for Oscillator Configurations and Frequencies of Operation (Commercial Devices)	215	Table 22-8: SPI Mode Requirements	259
Table 20-2: External Clock Timing Requirements	221	Table 22-9: I ² C Bus Start/Stop Bits Requirements	260
Table 20-3: CLKOUT and I/O Timing Requirements	222	Table 22-10: I ² C Bus Data Requirements	261
Table 20-4: Reset, Watchdog Timer, Oscillator Start-up Timer and Power-up Timer Requirements	223	Table 22-11: USART Synchronous Transmission Requirements	262
Table 20-5: Timer0 and Timer1 External Clock Requirements	224	Table 22-12: USART Synchronous Receive Requirements	262
Table 20-6: Capture/Compare/PWM Requirements (CCP1 and CCP2)	225	Table 23-1: Cross Reference of Device Specs for Oscillator Configurations and Frequencies of Operation (Commercial Devices)	263
Table 20-7: Parallel Slave Port Requirements	226	Table 23-2: External Clock Timing Requirements	269
Table 20-8: SPI Mode Requirements	227	Table 23-3: CLKOUT and I/O Timing Requirements	270
Table 20-9: I ² C Bus Start/Stop Bits Requirements	228	Table 23-4: Reset, Watchdog Timer, Oscillator Start-up Timer, Power-up Timer, and Brown-out Reset Requirements	271
Table 20-10: I ² C Bus Data Requirements	229		
Table 20-11: USART Synchronous Transmission Requirements	230		

PIC16C6X

Table 23-5:	Timer0 and Timer1 External Clock Requirements	272
Table 23-6:	Capture/Compare/PWM Requirements (CCP1 and CCP2)	273
Table 23-7:	Parallel Slave Port Requirements (PIC16C67) 274	
Table 23-8:	SPI Mode Requirements.....	277
Table 23-9:	I ² C Bus Start/Stop Bits Requirements	278
Table 23-10:	I ² C Bus Data Requirements	279
Table 23-11:	USART Synchronous Transmission Requirements	280
Table 23-12:	USART Synchronous Receive Requirements	280
Table 24-1:	RC Oscillator Frequencies	287
Table 24-2:	Capacitor Selection for Crystal Oscillators	288
Table E-1:	Pin Compatible Devices.....	315

ON-LINE SUPPORT

Microchip provides two methods of on-line support. These are the Microchip BBS and the Microchip World Wide Web (WWW) site.

Use Microchip's Bulletin Board Service (BBS) to get current information and help about Microchip products. Microchip provides the BBS communication channel for you to use in extending your technical staff with microcontroller and memory experts.

To provide you with the most responsive service possible, the Microchip systems team monitors the BBS, posts the latest component data and software tool updates, provides technical help and embedded systems insights, and discusses how Microchip products provide project solutions.

The web site, like the BBS, is used by Microchip as a means to make files and information easily available to customers. To view the site, the user must have access to the Internet and a web browser, such as Netscape or Microsoft Explorer. Files are also available for FTP download from our FTP site.

Connecting to the Microchip Internet Web Site

The Microchip web site is available by using your favorite Internet browser to attach to:

www.microchip.com

The file transfer site is available by using an FTP service to connect to:

<ftp://ftp.futureone.com/pub/microchip>

The web site and file transfer site provide a variety of services. Users may download files for the latest Development Tools, Data Sheets, Application Notes, User's Guides, Articles and Sample Programs. A variety of Microchip specific business information is also available, including listings of Microchip sales offices, distributors and factory representatives. Other data available for consideration is:

- Latest Microchip Press Releases
- Technical Support Section with Frequently Asked Questions
- Design Tips
- Device Errata
- Job Postings
- Microchip Consultant Program Member Listing
- Links to other useful web sites related to Microchip Products

Connecting to the Microchip BBS

Connect worldwide to the Microchip BBS using either the Internet or the CompuServe® communications network.

Internet:

You can telnet or ftp to the Microchip BBS at the address: **[mchipbbs.microchip.com](telnet://mchipbbs.microchip.com)**

CompuServe Communications Network:

When using the BBS via the Compuserve Network, in most cases, a local call is your only expense. The Microchip BBS connection does not use CompuServe membership services, therefore you do not need CompuServe membership to join Microchip's BBS. There is no charge for connecting to the Microchip BBS.

The procedure to connect will vary slightly from country to country. Please check with your local CompuServe agent for details if you have a problem. CompuServe service allow multiple users various baud rates depending on the local point of access.

The following connect procedure applies in most locations.

1. Set your modem to 8-bit, No parity, and One stop (8N1). This is not the normal CompuServe setting which is 7E1.
2. Dial your local CompuServe access number.
3. Depress the <Enter> key and a garbage string will appear because CompuServe is expecting a 7E1 setting.
4. Type +, depress the <Enter> key and "Host Name:" will appear.
5. Type MCHIPBBS, depress the <Enter> key and you will be connected to the Microchip BBS.

In the United States, to find the CompuServe phone number closest to you, set your modem to 7E1 and dial (800) 848-4480 for 300-2400 baud or (800) 331-7166 for 9600-14400 baud connection. After the system responds with "Host Name:", type NETWORK, depress the <Enter> key and follow CompuServe's directions.

For voice information (or calling from overseas), you may call (614) 723-1550 for your local CompuServe number.

Microchip regularly uses the Microchip BBS to distribute technical information, application notes, source code, errata sheets, bug reports, and interim patches for Microchip systems software products. For each SIG, a moderator monitors, scans, and approves or disapproves files submitted to the SIG. No executable files are accepted from the user community in general to limit the spread of computer viruses.

Systems Information and Upgrade Hot Line

The Systems Information and Upgrade Line provides system users a listing of the latest versions of all of Microchip's development systems software products. Plus, this line provides information on how customers can receive any currently available upgrade kits. The Hot Line Numbers are:

1-800-755-2345 for U.S. and most of Canada, and

1-602-786-7302 for the rest of the world.

970301

Trademarks: The Microchip name, logo, PIC, PICSTART, PICMASTER and PRO MATE are registered trademarks of Microchip Technology Incorporated in the U.S.A. and other countries. *FlexROM*, *MPLAB* and *fuzzyLAB*, are trademarks and SQTP is a service mark of Microchip in the U.S.A.

fuzzyTECH is a registered trademark of Inform Software Corporation. IBM, IBM PC-AT are registered trademarks of International Business Machines Corp. Pentium is a trademark of Intel Corporation. Windows is a trademark and MS-DOS, Microsoft Windows are registered trademarks of Microsoft Corporation. CompuServe is a registered trademark of CompuServe Incorporated.

All other trademarks mentioned herein are the property of their respective companies.

PIC16C6X Product Identification System

To order or to obtain information, e.g., on pricing or delivery, please use the listed part numbers, and refer to the factory or the listed sales offices.

PART NO.	-XX	X	/XX	XXX	
					Pattern: 3-Digit Pattern Code for QTP (blank otherwise)
					Package:
					L = PLCC
					SP = Skinny DIP
					P = PDIP
					SO = SOIC (Gull Wing, 300 mil body)
					PQ = MQFP (Metric PQFP)
					TQ = TQFP
					JW* = Windowed Cerdip
					SS = Shrink SOIC (Gull Wing, 300 mil body)
					Temperature Range:
					- = 0°C to +70°C (T for tape/reel)
					I = -40°C to +85°C (S for tape/reel)
					E = -40°C to +125°C
					Frequency Range:
					04 = 200 kHz (PIC16C6X-04)
					04 = 4 MHz
					10 = 10 MHz
					20 = 20 MHz
					Device:
					PIC16C6X :V _{DD} range 4.0V to 6.0V
					PIC16C6XT :V _{DD} range 4.0V to 6.0V (Tape and Reel)
					PIC16LC6X :V _{DD} range 2.5V to 6.0V
					PIC16LC6XT :V _{DD} range 2.5V to 6.0V (Tape and Reel)
					PIC16CR6X :V _{DD} range 4.0V to 6.0V
					PIC16CR6XT :V _{DD} range 4.0V to 6.0V (Tape and Reel)
					PIC16LCR6X :V _{DD} range 2.5V to 6.0V
					PIC16LCR6XT :V _{DD} range 2.5V to 6.0V
Examples:					
a) PIC16C62A - 04/P 301 = Commercial temp., PDIP package, 4 MHz, normal V _{DD} limits, QTP pattern #301					
b) PIC16LC65A - 04I/PQ = Industrial temp., MQFP package, 4 MHz, extended V _{DD} limits					
c) PIC16C67 - 10E/P = Extended temp., PDIP package, 10 MHz, normal V _{DD} limits					

* JW Devices are UV erasable and can be programmed to any device configuration. JW Devices meet the electrical requirement of each oscillator type (including LC devices).

Sales and Support

Products supported by a preliminary Data Sheet may possibly have an errata sheet describing minor operational differences and recommended workarounds. To determine if an errata sheet exists for a particular device, please contact one of the following:

1. The Microchip Website at www.microchip.com
2. Your local Microchip sales office (see following page)

PIC16C6X

Note the following details of the code protection feature on Microchip devices:

- Microchip products meet the specification contained in their particular Microchip Data Sheet.
- Microchip believes that its family of products is one of the most secure families of its kind on the market today, when used in the intended manner and under normal conditions.
- There are dishonest and possibly illegal methods used to breach the code protection feature. All of these methods, to our knowledge, require using the Microchip products in a manner outside the operating specifications contained in Microchip's Data Sheets. Most likely, the person doing so is engaged in theft of intellectual property.
- Microchip is willing to work with the customer who is concerned about the integrity of their code.
- Neither Microchip nor any other semiconductor manufacturer can guarantee the security of their code. Code protection does not mean that we are guaranteeing the product as "unbreakable."

Code protection is constantly evolving. We at Microchip are committed to continuously improving the code protection features of our products. Attempts to break Microchip's code protection feature may be a violation of the Digital Millennium Copyright Act. If such acts allow unauthorized access to your software or other copyrighted work, you may have a right to sue for relief under that Act.

Information contained in this publication regarding device applications and the like is provided only for your convenience and may be superseded by updates. It is your responsibility to ensure that your application meets with your specifications. MICROCHIP MAKES NO REPRESENTATIONS OR WARRANTIES OF ANY KIND WHETHER EXPRESS OR IMPLIED, WRITTEN OR ORAL, STATUTORY OR OTHERWISE, RELATED TO THE INFORMATION, INCLUDING BUT NOT LIMITED TO ITS CONDITION, QUALITY, PERFORMANCE, MERCHANTABILITY OR FITNESS FOR PURPOSE. Microchip disclaims all liability arising from this information and its use. Use of Microchip devices in life support and/or safety applications is entirely at the buyer's risk, and the buyer agrees to defend, indemnify and hold harmless Microchip from any and all damages, claims, suits, or expenses resulting from such use. No licenses are conveyed, implicitly or otherwise, under any Microchip intellectual property rights.

Trademarks

The Microchip name and logo, the Microchip logo, dsPIC, FlashFlex, KEELOQ, KEELOQ logo, MPLAB, PIC, PICmicro, PICSTART, PIC³² logo, rPIC, SST, SST Logo, SuperFlash and UNI/O are registered trademarks of Microchip Technology Incorporated in the U.S.A. and other countries.

FilterLab, Hampshire, HI-TECH C, Linear Active Thermistor, MTP, SEEVAL and The Embedded Control Solutions Company are registered trademarks of Microchip Technology Incorporated in the U.S.A.

Silicon Storage Technology is a registered trademark of Microchip Technology Inc. in other countries.

Analog-for-the-Digital Age, Application Maestro, BodyCom, chipKIT, chipKIT logo, CodeGuard, dsPICDEM, dsPICDEM.net, dsPICworks, dsSPEAK, ECAN, ECONOMONITOR, FanSense, HI-TIDE, In-Circuit Serial Programming, ICSP, MINDI, MiWi, MPASM, MPF, MPLAB Certified logo, MPLIB, MPLINK, mTouch, Omniclient Code Generation, PICC, PICC-18, PICDEM, PICDEM.net, PICkit, PICtail, REAL ICE, rFLAB, Select Mode, SQI, Serial Quad I/O, Total Endurance, TSHARC, UniWinDriver, WiperLock, ZENA and Z-Scale are trademarks of Microchip Technology Incorporated in the U.S.A. and other countries.

SQTP is a service mark of Microchip Technology Incorporated in the U.S.A.

GestIC and ULPP are registered trademarks of Microchip Technology Germany II GmbH & Co. & KG, a subsidiary of Microchip Technology Inc., in other countries.

All other trademarks mentioned herein are property of their respective companies.

© 1997-2013, Microchip Technology Incorporated, Printed in the U.S.A., All Rights Reserved.

 Printed on recycled paper.

ISBN: 9781620769652

**QUALITY MANAGEMENT SYSTEM
CERTIFIED BY DNV
= ISO/TS 16949 =**

Microchip received ISO/TS-16949:2009 certification for its worldwide headquarters, design and wafer fabrication facilities in Chandler and Tempe, Arizona; Gresham, Oregon and design centers in California and India. The Company's quality system processes and procedures are for its PIC® MCUs and dsPIC® DSCs, KEELOQ® code hopping devices, Serial EEPROMs, microperipherals, nonvolatile memory and analog products. In addition, Microchip's quality system for the design and manufacture of development systems is ISO 9001:2000 certified.

Worldwide Sales and Service

AMERICAS

Corporate Office
 2355 West Chandler Blvd.
 Chandler, AZ 85224-6199
 Tel: 480-792-7200
 Fax: 480-792-7277
 Technical Support:
<http://www.microchip.com/support>
 Web Address:
www.microchip.com

Atlanta
 Duluth, GA
 Tel: 678-957-9614
 Fax: 678-957-1455

Boston
 Westborough, MA
 Tel: 774-760-0087
 Fax: 774-760-0088

Chicago
 Itasca, IL
 Tel: 630-285-0071
 Fax: 630-285-0075

Cleveland
 Independence, OH
 Tel: 216-447-0464
 Fax: 216-447-0643

Dallas
 Addison, TX
 Tel: 972-818-7423
 Fax: 972-818-2924

Detroit
 Farmington Hills, MI
 Tel: 248-538-2250
 Fax: 248-538-2260

Indianapolis
 Noblesville, IN
 Tel: 317-773-8323
 Fax: 317-773-5453

Los Angeles
 Mission Viejo, CA
 Tel: 949-462-9523
 Fax: 949-462-9608

Santa Clara
 Santa Clara, CA
 Tel: 408-961-6444
 Fax: 408-961-6445

Toronto
 Mississauga, Ontario,
 Canada
 Tel: 905-673-0699
 Fax: 905-673-6509

ASIA/PACIFIC

Asia Pacific Office
 Suites 3707-14, 37th Floor
 Tower 6, The Gateway
 Harbour City, Kowloon
 Hong Kong
 Tel: 852-2401-1200
 Fax: 852-2401-3431
Australia - Sydney
 Tel: 61-2-9868-6733
 Fax: 61-2-9868-6755

China - Beijing
 Tel: 86-10-8569-7000
 Fax: 86-10-8528-2104

China - Chengdu
 Tel: 86-28-8665-5511
 Fax: 86-28-8665-7889

China - Chongqing
 Tel: 86-23-8980-9588
 Fax: 86-23-8980-9500

China - Hangzhou
 Tel: 86-571-2819-3187
 Fax: 86-571-2819-3189

China - Hong Kong SAR
 Tel: 852-2943-5100
 Fax: 852-2401-3431

China - Nanjing
 Tel: 86-25-8473-2460
 Fax: 86-25-8473-2470

China - Qingdao
 Tel: 86-532-8502-7355
 Fax: 86-532-8502-7205

China - Shanghai
 Tel: 86-21-5407-5533
 Fax: 86-21-5407-5066

China - Shenyang
 Tel: 86-24-2334-2829
 Fax: 86-24-2334-2393

China - Shenzhen
 Tel: 86-755-8864-2200
 Fax: 86-755-8203-1760

China - Wuhan
 Tel: 86-27-5980-5300
 Fax: 86-27-5980-5118

China - Xian
 Tel: 86-29-8833-7252
 Fax: 86-29-8833-7256

China - Xiamen
 Tel: 86-592-2388138
 Fax: 86-592-2388130

China - Zhuhai
 Tel: 86-756-3210040
 Fax: 86-756-3210049

ASIA/PACIFIC

India - Bangalore
 Tel: 91-80-3090-4444
 Fax: 91-80-3090-4123

India - New Delhi
 Tel: 91-11-4160-8631
 Fax: 91-11-4160-8632

India - Pune
 Tel: 91-20-2566-1512
 Fax: 91-20-2566-1513

Japan - Osaka
 Tel: 81-6-6152-7160
 Fax: 81-6-6152-9310

Japan - Tokyo
 Tel: 81-3-6880-3770
 Fax: 81-3-6880-3771

Korea - Daegu
 Tel: 82-53-744-4301
 Fax: 82-53-744-4302

Korea - Seoul
 Tel: 82-2-554-7200
 Fax: 82-2-558-5932 or
 82-2-558-5934

Malaysia - Kuala Lumpur
 Tel: 60-3-6201-9857
 Fax: 60-3-6201-9859

Malaysia - Penang
 Tel: 60-4-227-8870
 Fax: 60-4-227-4068

Philippines - Manila
 Tel: 63-2-634-9065
 Fax: 63-2-634-9069

Singapore
 Tel: 65-6334-8870
 Fax: 65-6334-8850

Taiwan - Hsin Chu
 Tel: 886-3-5778-3666
 Fax: 886-3-5770-955

Taiwan - Kaohsiung
 Tel: 886-7-213-7828
 Fax: 886-7-330-9305

Taiwan - Taipei
 Tel: 886-2-2508-8600
 Fax: 886-2-2508-0102

Thailand - Bangkok
 Tel: 66-2-694-1351
 Fax: 66-2-694-1350

EUROPE

Austria - Wels
 Tel: 43-7242-2244-39
 Fax: 43-7242-2244-393

Denmark - Copenhagen
 Tel: 45-4450-2828
 Fax: 45-4485-2829

France - Paris
 Tel: 33-1-69-53-63-20
 Fax: 33-1-69-30-90-79

Germany - Munich
 Tel: 49-89-627-144-0
 Fax: 49-89-627-144-44

Italy - Milan
 Tel: 39-0331-742611
 Fax: 39-0331-466781

Netherlands - Druenen
 Tel: 31-416-690399
 Fax: 31-416-690340

Spain - Madrid
 Tel: 34-91-708-08-90
 Fax: 34-91-708-08-91

UK - Wokingham
 Tel: 44-118-921-5869
 Fax: 44-118-921-5820



Компания «ЭлектроПласт» предлагает заключение долгосрочных отношений при поставках импортных электронных компонентов на взаимовыгодных условиях!

Наши преимущества:

- Оперативные поставки широкого спектра электронных компонентов отечественного и импортного производства напрямую от производителей и с крупнейших мировых складов;
- Поставка более 17-ти миллионов наименований электронных компонентов;
- Поставка сложных, дефицитных, либо снятых с производства позиций;
- Оперативные сроки поставки под заказ (от 5 рабочих дней);
- Экспресс доставка в любую точку России;
- Техническая поддержка проекта, помощь в подборе аналогов, поставка прототипов;
- Система менеджмента качества сертифицирована по Международному стандарту ISO 9001;
- Лицензия ФСБ на осуществление работ с использованием сведений, составляющих государственную тайну;
- Поставка специализированных компонентов (Xilinx, Altera, Analog Devices, Intersil, Interpoint, Microsemi, Aeroflex, Peregrine, Syfer, Eurofarad, Texas Instrument, Miteq, Cobham, E2V, MA-COM, Hittite, Mini-Circuits, General Dynamics и др.);

Помимо этого, одним из направлений компании «ЭлектроПласт» является направление «Источники питания». Мы предлагаем Вам помощь Конструкторского отдела:

- Подбор оптимального решения, техническое обоснование при выборе компонента;
- Подбор аналогов;
- Консультации по применению компонента;
- Поставка образцов и прототипов;
- Техническая поддержка проекта;
- Защита от снятия компонента с производства.



Как с нами связаться

Телефон: 8 (812) 309 58 32 (многоканальный)

Факс: 8 (812) 320-02-42

Электронная почта: org@eplast1.ru

Адрес: 198099, г. Санкт-Петербург, ул. Калинина, дом 2, корпус 4, литера А.