

BMD-300 Series Module for Bluetooth 5 LE

The **BMD-300 Series** from Rigado is a line of powerful, highly flexible, ultra-low power *Bluetooth* Smart modules based on the nRF52832 SoC from Nordic Semiconductor. With an ARM® Cortex™ M4F CPU, embedded 2.4GHz transceiver, and integrated antenna, they provide a complete RF solution with no additional RF design, allowing faster time to market. Providing full use of the nRF52832's capabilities and peripherals, the **BMD-300 Series** can power the most demanding applications, all while simplifying designs and reducing BOM costs. With an internal DC-DC converter and intelligent power control, the **BMD-300 Series** provide class-leading power efficiency, enabling ultra-low power sensitive applications. Regulatory pre-approvals reduce the burden to enter the market, and the included **BMD Software Suite** provides access to great features like a secure BLE & UART bootloader, iOS & Android Bluetooth libraries, and more. Available in three variants: internal antenna (**BMD-300**), U.FL connector (**BMD-301**), and ultra-miniature (**BMD-350**).

Bluetooth
 SMART

1. Features

- Based on the Nordic nRF52832 SoC
- Bluetooth 5 2M LE + Advertisement Extensions
- Complete RF solution with integrated antenna (**BMD-300 & BMD-350**) or U.FL connector (**BMD-301**)
- Integrated DC-DC converter
- No external components required
- ARM® Cortex™-M4F 32-bit processor
- Serial Wire Debug (SWD)
- Nordic SoftDevice ready
- Over-the-Air (OTA) firmware updates
- 512kB embedded flash memory
- 64kB RAM
- 32 General Purpose I/O Pins
- 12-bit/200KSPS ADC
- -40C to +85C Temperature Range
- BMD Software Suite included
- FCC: **2AA9B04** (BMD-300/BMD-301) **2AA9B05** (BMD-350)
- Three SPI Master/Slave (8 Mbps)
- Low power comparator
- Temperature sensor
- Random Number Generator
- Two 2-wire Master/Slave (I2C compatible)
- I2S audio interface
- UART (w/ CTS/RTS and DMA)
- 20 channel CPU independent Programmable Peripheral Interconnect (PPI)
- Quadrature Demodulator (QDEC)
- 128-bit AES HW encryption
- 5 x 32bit, 3 x 24bit Real Timer Counters (RTC)
- NFC-A tag interface for OOB pairing
- **BMD-300/301** Dimensions: 14 x 9.8 x 1.9mm
- **BMD-350** Dimensions: 8.7 x 6.4 x 1.5mm
- IC: **12208A-04** (BMD-300/BMD-301) **12208A-05** (BMD-350)
- Japan: **210-106799** (BMD-300) **210-107153** (BMD-301) **210-108944** (BMD-350)

2. Applications

- App-cessories
- Beacons – iBeacon™, AltBeacon, Eddystone, etc.
- Low-Power Sensors
- Lighting Products
- Fitness devices
- Wearables



3. Ordering Information

Email modules@rigado.com for quotes and ordering or visit www.rigado.com/BMD-300

Part Number	Description
BMD-300-A-R	BMD-300 module, Rev A, Tape & Reel, 1000 piece multiples
BMD-301-A-R	BMD-301 module, Rev A, Tape & Reel, 1000 piece multiples
BMD-350-A-R	BMD-350 module, Rev A, Tape & Reel, 1000 piece multiples
BMD-300-EVAL	BMD-300 Evaluation Kit with Segger J-Link programmer
BMD-301-EVAL	BMD-301 Evaluation Kit with Segger J-Link programmer w/antennas
BMD-350-EVAL	BMD-350 Evaluation Kit with Segger J-Link programmer

Table 1 – Ordering Part Numbers

4. Block Diagram

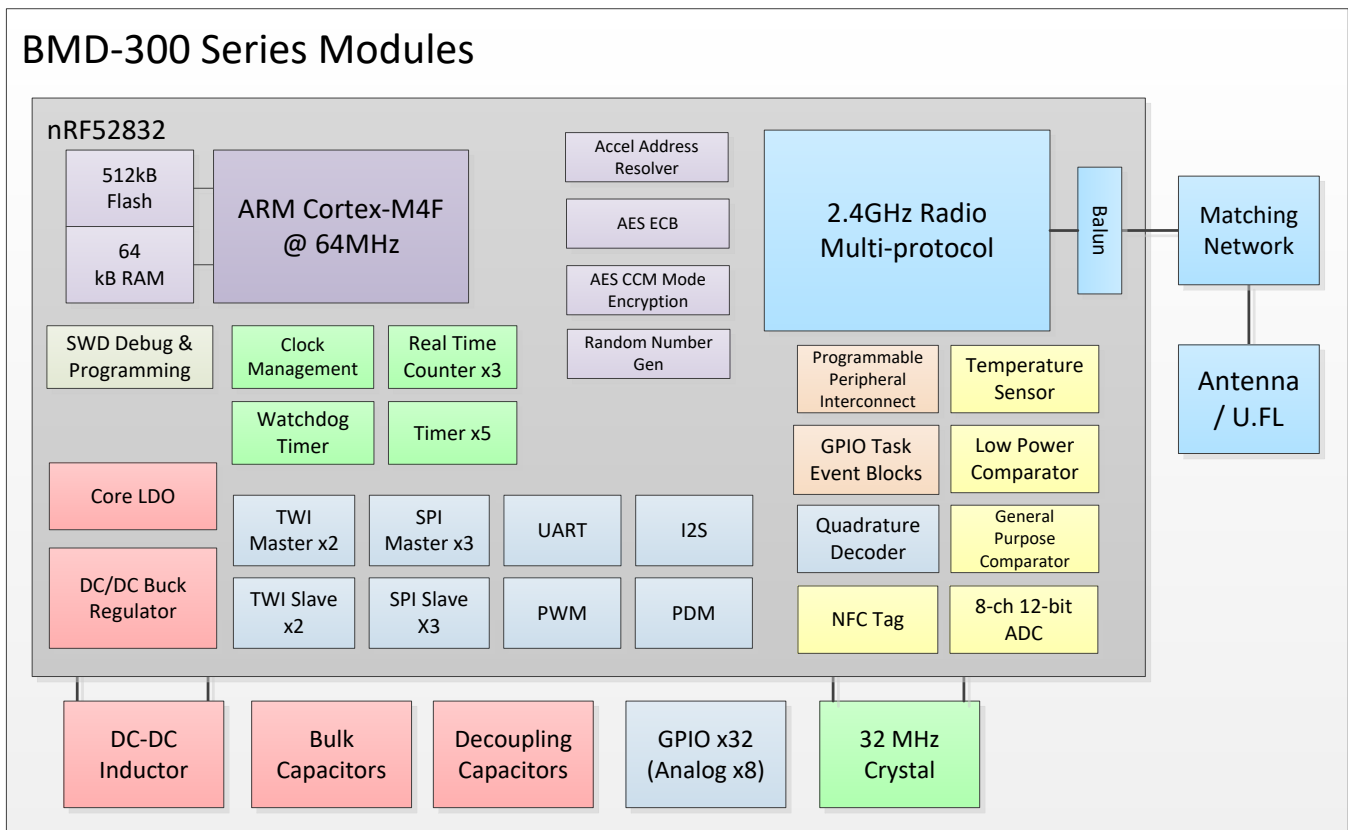

Figure 1 – Block Diagram

Table of Contents

1.	FEATURES.....	1
2.	APPLICATIONS.....	1
3.	ORDERING INFORMATION.....	2
4.	BLOCK DIAGRAM.....	2
5.	QUICK SPECIFICATIONS.....	5
6.	PIN DESCRIPTIONS.....	6
6.1	BMD-300 / BMD-301.....	6
6.2	BMD-350.....	7
6.3	RIGDFU PIN FUNCTIONS.....	9
6.4	BMDWARE PIN FUNCTIONS.....	9
7.	ELECTRICAL SPECIFICATIONS.....	10
7.1	ABSOLUTE MAXIMUM RATINGS.....	10
7.2	OPERATING CONDITIONS.....	10
7.3	GENERAL PURPOSE I/O.....	10
7.4	MODULE RESET.....	11
7.5	DEBUG & PROGRAMMING.....	11
7.6	CLOCKS.....	11
8.	FIRMWARE.....	14
8.1	FACTORY IMAGE.....	14
8.1.1	Firmware Version 'AA'.....	14
8.1.2	Firmware Version 'AB'.....	14
8.1.3	Firmware Version 'AC'.....	14
8.1.4	Firmware Version 'AD'.....	14
8.1.5	Firmware Version 'AE'.....	15
8.1.6	Module Programming and Read-Back Protection.....	15
8.2	SOFTDEVICES.....	16
8.2.1	S132.....	16
8.2.2	S212.....	16
8.2.3	S332.....	17
8.3	MAC ADDRESS INFO.....	17
9.	MECHANICAL DATA.....	18
9.1	MECHANICAL DIMENSIONS.....	18
9.1.1	BMD-300 Dimensions.....	18
9.1.2	BMD-301 Dimensions.....	18
9.1.3	BMD-350 Dimensions.....	19
9.2	RECOMMENDED PCB LAND PADS.....	19
9.2.1	BMD-300/301.....	19
9.2.2	BMD-350.....	20
10.	MODULE MARKING.....	20
10.1	BMD-300 MODULE MARKING.....	20
10.2	BMD-301 MODULE MARKING.....	21
10.3	BMD-350 MODULE MARKING.....	21
11.	RF DESIGN NOTES.....	22
11.1	RECOMMENDED RF LAYOUT & GROUND PLANE.....	22
11.1.1	BMD-300.....	22
11.1.2	BMD-301.....	22
11.1.3	BMD-350.....	22
11.2	MECHANICAL ENCLOSURE.....	23
11.3	ANTENNA PATTERNS.....	24
11.3.1	BMD-300.....	24
11.3.2	BMD-350.....	26
12.	EVALUATION BOARDS.....	27
13.	CUSTOM DEVELOPMENT.....	27
14.	BLUETOOTH QUALIFICATION.....	28
15.	REGULATORY STATEMENTS.....	28
15.1	FCC STATEMENT.....	28
15.2	FCC IMPORTANT NOTES.....	28
15.3	IC STATEMENT.....	30
15.4	IC IMPORTANT NOTES.....	30
15.5	CE REGULATORY.....	31
15.6	JAPAN (MIC).....	31

15.7	AUSTRALIA / NEW ZEALAND	32
15.8	APPROVED EXTERNAL ANTENNAS.....	32
15.9	BMD-350 MODULE LABELING.....	32
16.	SOLDER REFLOW TEMPERATURE-TIME PROFILE	33
16.1	MOISTURE SENSITIVITY LEVEL	33
17.	PACKAGING AND LABELING.....	33
17.1	CARRIER TAPE DIMENSIONS.....	33
17.1.1	BMD-300 & BMD-301	33
17.1.2	BMD-350	34
17.2	REEL PACKAGING.....	34
17.3	PACKAGING LABEL	35
18.	CAUTIONS.....	35
19.	LIFE SUPPORT POLICY	35
20.	DOCUMENT HISTORY	36
21.	RELATED DOCUMENTS.....	36

5. Quick Specifications

Bluetooth		
Version	5.0 Concurrent Central & Peripheral (S132), 2M LE + Advertisement Extensions	
Security	AES-128	
LE connections	Concurrent central, observer, peripheral, and broadcaster roles with up to twenty concurrent connections along with one Observer and one Broadcaster (S132)	
Radio		
Frequency	2.360GHz to 2.500GHz	
Modulations	GFSK at 1 Mbps, 2 Mbps data rates	
Transmit power	+4 dBm	
Receiver sensitivity	BMD-300/301: -96 dBm (BLE mode) BMD-350: -94 dBm (BLE mode)	
Antenna	BMD-300: Integrated BMD-301: U.FL Connector BMD-350: Ceramic Chip	
Current Consumption		
TX only @ +4 dBm, 0 dBm @ 3V, DCDC enabled	7.5 mA, 5.3 mA	
TX only @ +4 dBm, 0 dBm	16.6 mA, 11.6 mA	
RX only @ 1 Mbps @ 3V, DCDC enabled	5.4 mA	
RX only @ 1 Mbps	11.7 mA	
CPU @ 64MHz from flash, from RAM	7.4 mA, 6.7 mA	
CPU @ 64MHz from flash, from RAM @ 3V, DCDC	3.7 mA, 3.3 mA	
System Off, On	0.3 μ A, 1.2 μ A	
Additional current for RAM retention	30 nA / 4KB block	
Dimensions		
BMD-300 BMD-301	Length Width Height	14.0 mm \pm 0.3mm 9.8 mm \pm 0.3mm 1.9 mm \pm 0.1mm
BMD-350	Length Width Height	8.7 mm \pm 0.2mm 6.4 mm \pm 0.2mm 1.5 mm \pm 0.1mm
Hardware		
Interfaces	SPI Master/Slave x 3 UART Two-Wire Master/Slave (I2C) x 2 GPIO x 32	I2S PWM PDM
Power supply	1.7V to 3.6V	
Temperature Range	-40C to +85°C	
Certifications		
FCC	FCC part 15 modular certification BMD-300/BMD-301 FCC ID: 2AA9B04 BMD-350 FCC ID: 2AA9B05	
IC	Industry Canada RSS-210 modular certification BMD-300/BMD-301 IC: 12208A-04 BMD-350 IC: 12208A-05	
CE	EN 60950-1: A2:2013 3.1 (a): Health and Safety of the User EN 301 489-1 V2.1.1 & 3.1 (b): Electromagnetic Compatibility EN 301 489-17 V3.1.1 EN 300 328 V2.1.1 3.2: Effective use of spectrum allocated	
Japan (MIC)	Ministry of Internal Affairs and Communications (MIC) of Japan pursuant to the Radio Act of Japan BMD-300: 210-106799 BMD-301: 210-107153 BMD-350: 210-108944	
Australia / New Zealand	AS/NZS 4268 :2012+AMDT 1:2013, Radio equipment and systems – Short range devices	
Bluetooth	BMD-300/301 BT4.2 RF-PHY Component (Tested) – DID: D030629; QDID: 81876 BMD-300/301 BT5 RF-PHY Component (Tested) – DID: D037298; QDID: 101625 BMD-350 BT4.2 RF-PHY Component (Tested) – DID: D036284; QDID: 98865 BMD-350 BT5 RF-PHY Component (Tested) – DID: D037181; QDID: 101018	
Export		
BMD-300 BMD-301 BMD-350	ECCN: 5A992.C, Exception 742.15(b)(1) HTS: 8473.30.1180	

Table 2 – Quick Specifications

6. Pin Descriptions

6.1 BMD-300 / BMD-301

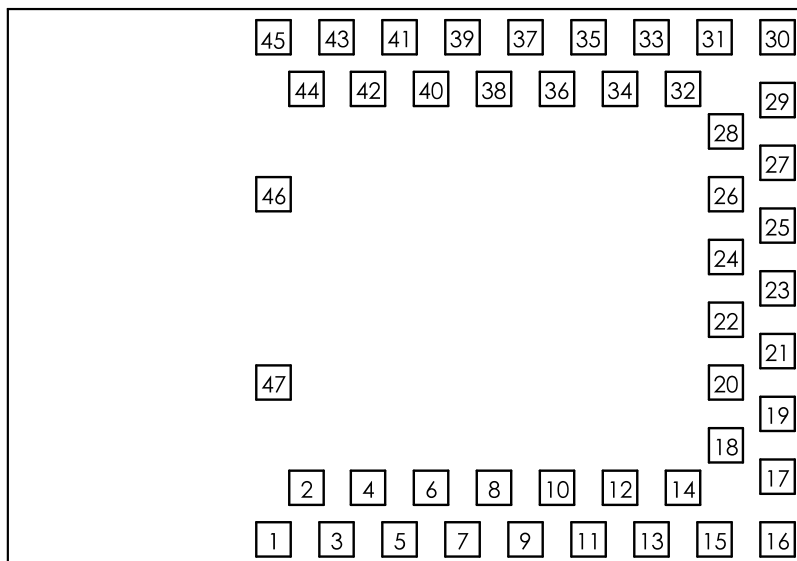

Figure 2 – BMD-300/301 Pin out (Top View)

Pin description

Pin	Name	Direction	Description
6	P0.25	In/Out	GPIO ²
7	P0.26	In/Out	GPIO ²
8	P0.27	In/Out	GPIO ²
9	P0.28	In/Out	GPIO/AIN4 ²
10	P0.29	In/Out	GPIO/AIN5 ²
11	P0.30	In/Out	GPIO/AIN6 ²
12	P0.31	In/Out	GPIO/AIN7 ²
13	P0.00	In/Out	GPIO/XTAL1 (32.768kHz)
14	P0.01	In/Out	GPIO/XTAL2 (32.768kHz)
15	P0.02	In/Out	GPIO/AIN0
19	P0.03	In/Out	GPIO/AIN1
20	P0.04	In/Out	GPIO/AIN2
21	P0.05	In/Out	GPIO/AIN3
22	P0.06	In/Out	GPIO
23	P0.07	In/Out	GPIO
24	P0.08	In/Out	GPIO
25	P0.09	In/Out	GPIO/NFC1
26	P0.10	In/Out	GPIO/NFC2
27	P0.11	In/Out	GPIO
28	P0.12	In/Out	GPIO
31	P0.13	In/Out	GPIO
32	P0.14	In/Out	GPIO/TRACEDATA[3]
33	P0.15	In/Out	GPIO/TRACEDATA[2]

Pin	Name	Direction	Description
34	P0.16	In/Out	GPIO/TRACEDATA[1]
35	P0.17	In/Out	GPIO
36	P0.18	In/Out	GPIO/TRACEDATA[0]/SWO
37	P0.19	In/Out	GPIO
38	P0.20	In/Out	GPIO/TRACECLK
39	P0.21	In/Out	GPIO/RESET
40	P0.22	In/Out	GPIO ²
41	P0.23	In/Out	GPIO ²
42	P0.24	In/Out	GPIO ²
43	SWCLK	In	SWD Clock
44	SWDIO	In/Out	SWD IO
17	VCC	Power	+1.7V to +3.6V ¹
1, 2, 3, 4, 5, 16, 18, 29, 30, 45, 46, 47	GND	Power	Electrical Ground

Note 1: An internal 4.7μF bulk capacitor is included on the module. However, it is good design practice to add additional bulk capacitance as required for your application, i.e. those with heavy GPIO usage and/or current draw.

Note 2: These pins are in close proximity to the nRF52 radio power supply and antenna pins. Radio performance parameters, such as sensitivity, may be affected by high frequency digital I/O with large sink/source current on these pins. Nordic recommends using only low frequency, low-drive functions when possible.

Table 3 – BMD-300/301 Pin Descriptions

6.2 BMD-350

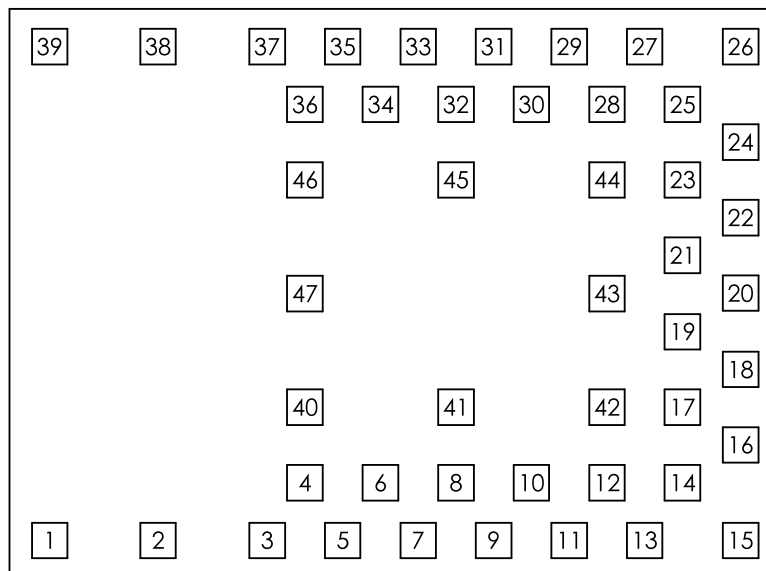
Figure 3 – BMD-350 Pin out (Top View)

Pin description

Pin	Name	Direction	Description
4	SWCLK	In	SWD Clock
5	SWDIO	In/Out	SWD IO
6	P0.20	In/Out	GPIO/TRACECLK
7	P0.21	In/Out	GPIO/RESET

Pin	Name	Direction	Description
8	P0.18	In/Out	GPIO/TRACEDATA[0]/SWO
9	P0.16	In/Out	GPIO/TRACEDATA[1]
10	P0.17	In/Out	GPIO
11	P0.15	In/Out	GPIO/TRACEDATA[2]
12	P0.13	In/Out	GPIO
13	P0.12	In/Out	GPIO
14	P0.14	In/Out	GPIO/TRACEDATA[3]
16	P0.09	In/Out	GPIO/NFC1
17	P0.10	In/Out	GPIO/NFC2
18	P0.11	In/Out	GPIO
19	P0.06	In/Out	GPIO
20	P0.08	In/Out	GPIO
21	P0.05	In/Out	GPIO/AIN3
22	P0.07	In/Out	GPIO
23	P0.01	In/Out	GPIO/XTAL2 (32.768kHz)
24	P0.00	In/Out	GPIO/XTAL1 (32.768kHz)
27	P0.04	In/Out	GPIO/AIN2
28	P0.02	In/Out	GPIO/AIN0
29	P0.30	In/Out	GPIO/AIN6 ²
30	P0.31	In/Out	GPIO/AIN7 ²
31	P0.29	In/Out	GPIO/AIN5 ²
32	P0.27	In/Out	GPIO ²
33	P0.25	In/Out	GPIO ²
34	P0.26	In/Out	GPIO ²
35	P0.23	In/Out	GPIO ²
36	P0.24	In/Out	GPIO ²
41	P0.22	In/Out	GPIO ²
42	P0.19	In/Out	GPIO
44	P0.03	In/Out	GPIO/AIN1
45	P0.28	In/Out	GPIO/AIN4 ²
25	VCC	Power	+1.7V to +3.6V ¹
1, 2, 3, 15, 26, 37, 38, 39, 40, 43, 46, 47	GND	Power	Electrical Ground

Note 1: An internal 4.7 μ F bulk capacitor is included on the module. However, it is good design practice to add additional bulk capacitance as required for your application, i.e. those with heavy GPIO usage and/or current draw.

Note 2: These pins are in close proximity to the nRF52 radio power supply and antenna pins. Radio performance parameters, such as sensitivity, may be affected by high frequency digital I/O with large sink/source current on these pins. Nordic recommends using only low frequency, low-drive functions when possible.

Table 4 – BMD-350 Pin Descriptions

6.3 RigDFU Pin Functions

NOTICE: Rigado now provides source code through our GitHub repositories for RigDFU, BMDware, Rigablue developer tools and mobile apps for customers to customize and extend on their own. We recommend that projects for the BMD-300, BMD-301 and BMD-350 target Nordic's tools for any new development. This will allow access to the very latest tools from Nordic and provide an ongoing path as new features are released. Please refer to [this article](#).

Rigado RigDFU is programmed on the BMD-300 Series at the factory. Two GPIO pins are configured as UART pins for transferring new firmware images to the BMD-300. Pins are configured only when bootloader is running, and are fully available to the application firmware. RigDFU can be removed from the BMD-300 by performing a full-chip erase.

BMD-300/1 Pin	BMD-350 Pin	Name	Direction	RigDFU Functions
22	19	P0.06	Out	UART TX for bootloader <i>Hi-Z until bootloader activation message received on UART RX.</i>
24	20	P0.08	In	UART RX for bootloader <i>Internal 13kΩ pull-down enabled</i>

Table 5 – RigDFU Functions

6.4 BMDware Pin Functions

NOTICE: Rigado now provides source code through our GitHub repositories for RigDFU, BMDware, Rigablue developer tools and mobile apps for customers to customize and extend on their own. We recommend that projects for the BMD-300, BMD-301 and BMD-350 target Nordic's tools for any new development. This will allow access to the very latest tools from Nordic and provide an ongoing path as new features are released. Please refer to [this article](#).

Rigado BMDware is programmed on the BMD-300 Series at the factory. BMDware provides UART-to-BLE Bridge, beaconing, and Direct Test Mode (DTM) functionality. The pins in Table 6 below describe the pin functionality in BMDware. DTM Mode, Beacon-Only Mode, and AT Command Mode pin states are checked at BMDware start-up to configure BMDware as required by the user, and are then set to Hi-Z to conserve power. For further details on BMDware operation, please see the BMDware Datasheet that can be found at www.rigado.com. BMDware can be overwritten by RigDFU with custom application firmware, or removed along with RigDFU by a full chip erase.

BMD-300/1 Pin	BMD-350 Pin	Name	Direction	BMDware Functions
21	21	P0.05	Out	Bridge UART RTS Disabled in Beacon-Only & DTM modes, N/C if not used.
22	19	P0.06	Out	Bridge UART TX Disabled in Beacon-Only & DTM modes, N/C if not used.
23	22	P0.07	In	Bridge UART CTS Disabled in Beacon-Only & DTM modes, N/C if not used.
24	20	P0.08	In	Bridge UART RX Disabled in Beacon-Only & DTM modes, N/C if not used.
27	18	P0.11	Out	DTM UART TX Only enabled in DTM mode; N/C if not used.

BMD-300/1 Pin	BMD-350 Pin	Name	Direction	BMDware Functions
28	13	P0.12	In	DTM UART RX / DTM Mode Only enabled in DTM mode; N/C if not used. On BMDware Start-up: High = Enter DTM mode; Low = Enter Normal Operation <i>Internal 13kΩ pull-down during BMDware start-up, then Hi-Z</i>
31	12	P0.13	In	Beacon Only Mode On BMDware Start-up: High = Bridge UART enabled; Low = Bridge UART disabled <i>Internal 13kΩ pull-up during BMDware start-up, then Hi-Z</i>
32	14	P0.14	In	UART AT Command Mode On BMDware Start-up: High = Full pass-through mode; Low = AT command mode <i>Internal 13kΩ pull-up during BMDware start-up, then Hi-Z</i>

Table 6 – BMDware Functions at Start-up

7. Electrical Specifications

7.1 Absolute Maximum Ratings

Symbol	Parameter	Min.	Max.	Unit
V_{CC_MAX}	Voltage on supply pin	-0.3	3.9	V
V_{IO_MAX}	Voltage on GPIO pins ($V_{CC} > 3.6V$)	-0.3	3.9	V
V_{IO_MAX}	Voltage on GPIO pins ($V_{CC} \leq 3.6V$)	-0.3	$V_{CC} + 0.3V$	V
T_S	Storage Temperature Range	-40	125	°C

Table 7 – Absolute Maximum Ratings

7.2 Operating Conditions

Symbol	Parameter	Min.	Typ.	Max.	Unit
V_{CC}	Operating supply voltage	1.7	3.0	3.6	V
T_{R_VCC}	Supply rise time (0V to 1.7V)	-	-	60	ms
T_A	Operating Ambient Temperature Range	-40	25	85	°C

Table 8 – Operating Conditions

7.3 General Purpose I/O

The general purpose I/O is organized as one port enabling access and control of the 32 available GPIO pins through one port. Each GPIO can be accessed individually with the following user configurable features:

- Input/output direction
- Output drive strength
- Internal pull-up and pull-down resistors
- Wake-up from high or low level triggers on all pins
- Trigger interrupt on all pins
- All pins can be used by the PPI task/event system; the maximum number of pins that can be interfaced through the PPI at the same time is limited by the number of GPIOTE channels
- All pins can be individually configured to carry serial interface or quadrature demodulator signals

Symbol	Parameter	Min.	Typ.	Max.	Unit
V _{IH}	Input High Voltage	0.7 x V _{CC}	-	V _{CC}	V
V _{IL}	Input Low Voltage	V _{SS}	-	0.3 x V _{CC}	V
V _{OH}	Output High Voltage	V _{CC} - 0.4	-	V _{CC}	V
V _{OL}	Output Low Voltage	V _{SS}	-	V _{SS} + 0.4	V
R _{PU}	Pull-up Resistance	11	13	16	kΩ
R _{PD}	Pull-down Resistance	11	13	16	kΩ

Table 9 – GPIO

7.4 Module RESET

GPIO pin P0.21 may be used for a hardware reset. In order to utilize P0.21 as a hardware reset, the UICR registers PSELRESET[0] and PSELRESET[1] must be set alike, to the value of 0x7FFFFFFF. When P0.21 is programmed as $\overline{\text{RESET}}$, the internal pull-up is automatically enabled. Rigado and Nordic example applications and development kits program P0.21 as $\overline{\text{RESET}}$.

7.5 Debug & Programming

The BMD-300 Series supports the two pin Serial Wire Debug (SWD) interface and offers flexible and powerful mechanism for non-intrusive debugging of program code. Breakpoints, single stepping, and instruction trace capture of code execution flow are part of this support.

The BMD-300 also supports ETM and ITM trace. Trace data from the ETM and the ITM is sent to an external debugger via a 4-bit wide parallel trace port. In addition to parallel trace, the TPIU supports serial trace via the Serial Wire Output (SWO) trace protocol.

7.6 Clocks

The BMD-300 Series requires two clocks, a high frequency clock and a low frequency clock.

The high frequency clock is provided on-module by a high-accuracy 32-MHz crystal as required by the nRF52832 for radio operation.

The low frequency clock can be provided internally by an RC oscillator or synthesized from the fast clock; or externally by a 32.768 kHz crystal. An external crystal provides the lowest power consumption and greatest accuracy. Using the internal RC oscillator with calibration provides acceptable performance for BLE applications at a reduced cost and slight increase in power consumption. Note: the ANT protocol requires the use of an external crystal.

32.768 kHz Crystal (LFXO)

Symbol	Parameter	Typ.	Max.	Unit
F _{NOM_LFXO}	Crystal frequency	32.768	-	kHz
F _{TOL_LFXO_BLE}	Frequency tolerance, BLE applications	-	±250	ppm
C _{L_LFXO}	Load Capacitance	-	12.5	pF
C _{O_LFXO}	Shunt Capacitance	-	2	pF
R _{S_LFXO}	Equivalent series resistance	-	100	kΩ

C_{pin}	Input Capacitance on XL1 & XL2 pads	4	-	pF
-----------	-------------------------------------	---	---	----

Table 10 – 32.768 kHz Crystal

32.768 kHz Oscillator Comparison

Symbol	Parameter	Min.	Typ.	Max.	Unit
I_{LFXO}	Current for 32.768kHz Crystal Oscillator	-	0.25	-	μA
I_{LFRC}	Current for 32.768kHz RC Oscillator	-	0.6	1	μA
I_{LFSYNT}	Current for 32.768kHz Synthesized Oscillator	-	100	-	μA
$f_{TOL_LFXO_BLE}$	Frequency Tolerance, 32.768kHz Crystal Oscillator (BLE Stack) ¹	-	-	± 250	ppm
$f_{TOL_LFXO_ANT}$	Frequency Tolerance, 32.768kHz Crystal Oscillator (ANT Stack) ¹	-	-	± 50	ppm
f_{TOL_LFRC}	Frequency Tolerance, 32.768kHz RC Oscillator	-	-	± 2	%
$f_{TOL_CAL_LFRC}$	Frequency tolerance, 32.768kHz RC after calibration	-	-	± 250	ppm
f_{TOL_LFSYNT}	Frequency Tolerance, 32.768kHz Synthesized Oscillator	-	-	± 48	ppm

Note 1: $f_{TOL_LFXO_BLE}$ and $f_{TOL_LFXO_ANT}$ are the max allowed for BLE and ANT applications. Actual tolerance depends on the crystal used.

Table 11 – 32.768 kHz Oscillator

8. Firmware

NOTICE: Rigado now provides source code through our GitHub repositories for RigDFU, BMDware, Rigablue developer tools and mobile apps for customers to customize and extend on their own. We recommend that projects for the BMD-300, BMD-301 and BMD-350 target Nordic's tools for any new development. This will allow access to the very latest tools from Nordic and provide an ongoing path as new features are released. Please refer to [this article](#).

8.1 Factory Image

All modules are shipped with factory programmed firmware. The factory programmed firmware version is indicated on the label.

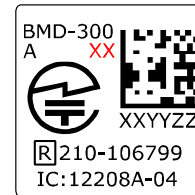

Factory Firmware
Version Code: **XX**

8.1.1 Firmware Version 'AA'

Factory firmware version 'AA' contains the Rigado RigDFU OTA and Serial bootloader v3.2.0 (42), Nordic S132 SoftDevice v2.0.0, and Rigado BMDware v3.1.0 (50). Modules can be programmed with customer code via BLE and UART interfaces using the bootloader and Rigado provided tools, or with a full-chip erase via the SWD interface. Examples apps for iOS and Android are provided that utilize the Rigablue Library for easy OTA updates. Visit the BMD Software Suite page at www.rigado.com for more information.

Note: A full chip erase will clear the Rigado assigned MAC address from memory; see section 8.3 "MAC Address Info" on how to retain it.

8.1.2 Firmware Version 'AB'

Factory firmware version 'AB' contains the Rigado RigDFU OTA and Serial bootloader v3.2.1 (43), Nordic S132 SoftDevice v2.0.0, and Rigado BMDware v3.1.1 (51). Modules can be programmed with customer code via BLE and UART interfaces using the bootloader and Rigado provided tools, or with a full-chip erase via the SWD interface. Examples apps for iOS and Android are provided that utilize the Rigablue Library for easy OTA updates. Visit the BMD Software Suite page at www.rigado.com for more information.

Note: A full chip erase will clear the Rigado assigned MAC address from memory; see section 8.3 "MAC Address Info" on how to retain it.

8.1.3 Firmware Version 'AC'

Factory firmware version 'AC' contains the Rigado RigDFU OTA and Serial bootloader v3.2.2 (44), Nordic S132 SoftDevice v2.0.0, and Rigado BMDware v3.1.1 (51). Modules can be programmed with customer code via BLE and UART interfaces using the bootloader and Rigado provided tools, or with a full-chip erase via the SWD interface. Examples apps for iOS and Android are provided that utilize the Rigablue Library for easy OTA updates. Visit the BMD Software Suite page at www.rigado.com for more information.

Note: A full chip erase will clear the Rigado assigned MAC address from memory; see section 8.3 "MAC Address Info" on how to retain it. **Note: Readback protection is not enabled by default.**

8.1.4 Firmware Version 'AD'

Factory firmware version 'AD' contains the Rigado RigDFU OTA and Serial bootloader v3.3.1 (46), Nordic S132 SoftDevice v3.1.0, and Rigado BMDware v3.2.1 (60). Modules can be programmed with customer code via BLE and UART interfaces using the bootloader and Rigado provided tools, or with a full-chip erase via the SWD interface. Examples apps for iOS and Android are provided that utilize the Rigablue Library for easy OTA updates. Visit the BMD Software Suite page at www.rigado.com for more information.

Note: A full chip erase will clear the Rigado assigned MAC address from memory; see section 8.3 "MAC Address Info" on how to retain it. **Note: Readback protection is not enabled by default.**

8.1.5 Firmware Version 'AE'

Factory firmware version 'AD' contains the Rigado RigDFU OTA and Serial bootloader v3.4.0 (47), Nordic S132 SoftDevice v3.1.0, and Rigado BMDware v3.2.1 (60). Modules can be programmed with customer code via BLE and UART interfaces using the bootloader and Rigado provided tools, or with a full-chip erase via the SWD interface. Examples apps for iOS and Android are provided that utilize the Rigablue Library for easy OTA updates. Visit the BMD Software Suite page at www.rigado.com for more information.

Note: A full chip erase will clear the Rigado assigned MAC address from memory; see section 8.3 "MAC Address Info" on how to retain it. **Note: Readback protection is not enabled by default. 'AE' marked units should not be loaded with previous factory firmware due to Nordic nRF52832 Errata #108.**

8.1.6 Module Programming and Read-Back Protection

RigDFU allows for UART and OTA updates to RigDFU, the SoftDevice and application firmware. Read-back protection of the BMD-300 Series modules is enabled which prevents unauthorized access to the firmware and optional encryption keys through the SWD debug port.

If the SWD port is required, for example when developing custom firmware, the nRF52 must be erased and recovered. **Note: Without this step, the module will not be recognized by most programmers.** This is accomplished with the Rigado BMD-300 Eraser and Recovery Utility at www.rigado.com, or with nrfjprog, which is provided with the Nordic Semiconductor command line utilities:

```
nrfjprog -f NRF52 --recover
```

A full chip erase is performed, so all components will need to be re-loaded (RigDFU Bootloader, SoftDevice and application Firmware). The [rigado/bootloader-tools](https://github.com/rigado/bootloader-tools) repository on GitHub contains the utilities to load these items. Procedures are described in the RigDFU Datasheet at www.rigado.com for programming, firmware preparation, and update procedures.

The BMD-300 Series modules may also be restored to the factory firmware versions noted above with the utilities available at the [rigado/programming](https://github.com/rigado/programming) repository on GitHub.

Access to the Rigado BMD Software Suite may be requested on the [Rigado Website](http://www.rigado.com).

8.1.6.1 With Factory Firmware 'AC' and later

Modules with factory firmware code 'AC' and later no longer ship with read-back protection enabled from the factory. Rigado RigDFU bootloader v3.2.2 and later enable read-back protection when an encryption key is loaded onto the module. This allows the modules to be recognized more easily by programmers, and allows the factory MAC address to be read directly through the SWD interface.

8.2 SoftDevices

Nordic Semiconductor protocol stacks are known as SoftDevices. SoftDevices are pre-compiled, pre-linked binary files. SoftDevices can be programmed in nRF52 series SoCs and are downloadable from the Nordic website. The BMD-300 with the nRF52832 SoC supports the S132 (BLE Central & Peripheral), S212 (ANT) and S312 (ANT and BLE) SoftDevices.

8.2.1 S132

The S132 SoftDevice is a Bluetooth® low energy (BLE) Central and Peripheral protocol stack solution supporting up to twenty connections with an additional Observer and a Broadcaster role all running concurrently. The S132 SoftDevice integrates a BLE Controller and Host, and provides a full and flexible API for building Bluetooth Smart nRF52 System on Chip (SoC) solutions.

Key Features

- *Bluetooth 5.0 compliant low energy single-mode protocol stack suitable for Bluetooth Smart products*
 - *Concurrent central, observer, peripheral, and broadcaster roles with up to twenty concurrent connections along with one Observer and one Broadcaster*
 - *Configurable number of connections and connection properties*
 - *Configurable attribute table size*
 - *Custom UUID support*
 - *Link layer supporting LE 1M PHY and LE 2M PHY*
 - *LL Privacy*
 - *LE Data Packet Length Extension*
 - *ATT and SM protocols*
 - *L2CAP with LE Credit-based Flow Control*
 - *LE Secure Connections pairing model*
 - *GATT and GAP APIs*
 - *GATT Client and Server*
 - *Configurable ATT MTU*
- *Complementary nRF5 SDK including Bluetooth profiles and example applications*
- *Master Boot Record for over-the-air device firmware update*
 - *SoftDevice, application, and bootloader can be updated separately*
- *Memory isolation between the application and the protocol stack for robustness and security*
- *Thread-safe supervisor-call based API*
- *Asynchronous, event-driven behavior*
- *No RTOS dependency*
 - *Any RTOS can be used*
- *No link-time dependencies*
 - *Standard ARM® Cortex®-M4 project configuration for application development*
- *Support for concurrent and non-concurrent multiprotocol operation*
 - *Concurrent with the Bluetooth stack using Radio Timeslot API*
 - *Alternate protocol stack in application space*
- *Support for control of external Power Amplifiers and Low Noise Amplifiers*

8.2.2 S212

The S212 SoftDevice is an ANT™ protocol stack solution that provides a full and flexible Application Programming Interface (API) for building ANT System on Chip (SoC) solutions for the nRF52832 chip. The S212 SoftDevice simplifies combining the ANT protocol stack and an application on the same CPU.

Key Features

- **Advanced ANT stack**
 - *Simple to complex network topologies:*
 - *Peer-to-peer, Star, Tree, Star-to-star and more*
 - *Up to 15 logical channels, each with configurable:*
 - *Channel type, ID and period*
 - *RF frequency*
 - *Networks*
 - *Broadcast, Acknowledged, and Burst Data modes*
 - *Device search, pairing and proximity support*
 - *Enhanced ANT features:*
 - *Advanced Burst Transfer mode (up to 60 kbps)*
 - *Up to 15 channels encryption (AES-128) support*
 - *Additional networks – up to 8*
 - *Event Filtering and Selective Data Updates*
 - *Asynchronous Transmission*
 - *Fast Channel Initiation*

SoftDevice features

- Built-in NVM access and radio coexistence management
 - Master Boot Record for over-the air device firmware update
 - Memory isolation between application and protocol stack for robustness and security
 - Thread-safe supervisor-call based API
 - Asynchronous, event-driven behavior
 - No RTOS dependency
- Any RTOS can be used
 - No link-time dependencies
 - Standard ARM® Cortex™ -M4F project configuration for application development
- Support for concurrent and non-concurrent multiprotocol operation
 - Concurrent multiprotocol timeslot API
 - Alternate protocol stack running in application space

8.2.3 S332

The S332 SoftDevice is a combined ANT and Bluetooth low energy (BLE) protocol stack solution. It supports all four Bluetooth low energy roles (central, peripheral, observer, broadcaster) and ANT.

The S332 SoftDevice provides a full and flexible Application Programming Interface (API) for building concurrent ANT and BLE System on Chip (SoC) solutions. It simplifies combining an ANT and BLE protocol stack and an application on the same CPU, therefore eliminating the need for an added device to support concurrent multiprotocol.

8.3 MAC Address Info

The BMD-300 Series modules comes preprogrammed with a unique MAC address from the factory. The MAC address is also printed on a 2D barcode on the top of the module.

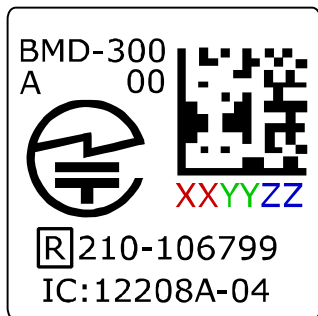

Figure 4 – BMD-300/301 MAC Address on Label

MAC Address:
94:54:93:XX:YY:ZZ

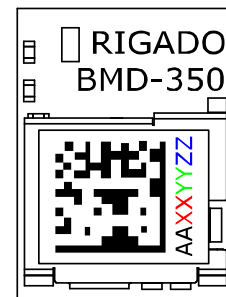

Figure 5 – BMD-350 MAC Address on Label

The 6-byte BLE Radio MAC address is stored in the nRF52832 UICR at NRF_UICR_BASE+0x80 LSB first. Please read the MAC Address Provisioning application note if you are not using the built-in bootloader to avoid erasing/overwriting the MAC address during programming. **Important:** The BMD-300 comes with full memory protection enabled, not allowing the UICR to be read via the SWD interface. If performing a full-erase, the MAC can then only be recovered from the 2D barcode and human-readable text. **Note:** Modules with factory firmware code 'AC' and later no longer enable read-back protection from the factory, allowing the MAC address to be read with an SWD programmer.

UICR Register:

- NRF_UICR + 0x80 (0x10001080): MAC_Addr [0] (0xZZ)
- NRF_UICR + 0x81 (0x10001081): MAC_Addr [1] (0xYY)
- NRF_UICR + 0x82 (0x10001082): MAC_Addr [2] (0xXX)
- NRF_UICR + 0x83 (0x10001083): MAC_Addr [3] (0x93)
- NRF_UICR + 0x84 (0x10001084): MAC_Addr [4] (0x54)
- NRF_UICR + 0x85 (0x10001085): MAC_Addr [5] (0x94)

9. Mechanical Data

9.1 Mechanical Dimensions

9.1.1 BMD-300 Dimensions

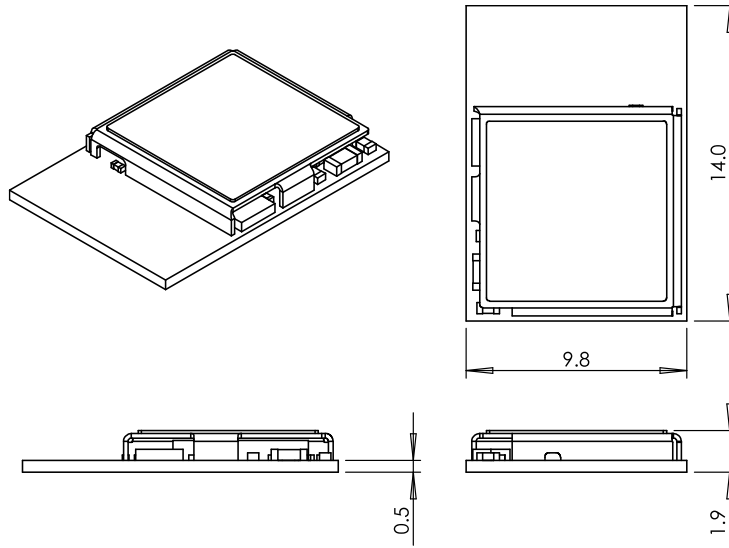

Figure 6 – BMD-300 Module Dimensions

(All dimensions are in mm)

9.1.2 BMD-301 Dimensions

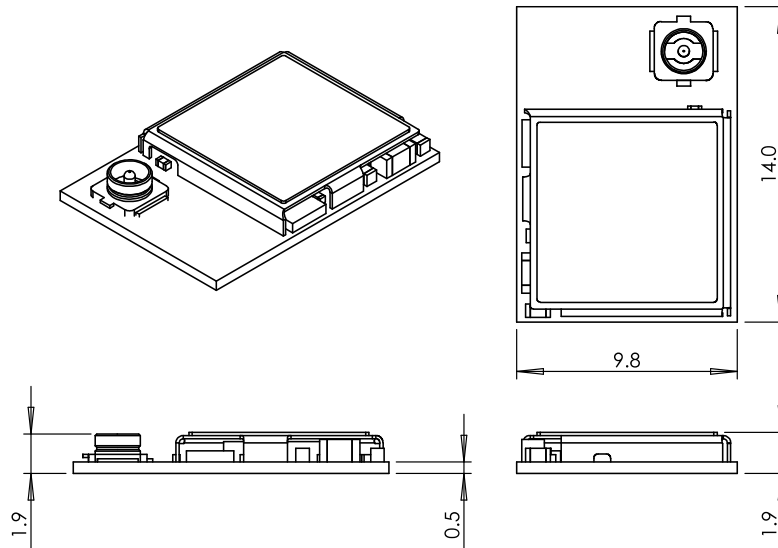

Figure 7 – BMD-301 Module Dimensions

(All dimensions are in mm)

9.1.3 BMD-350 Dimensions

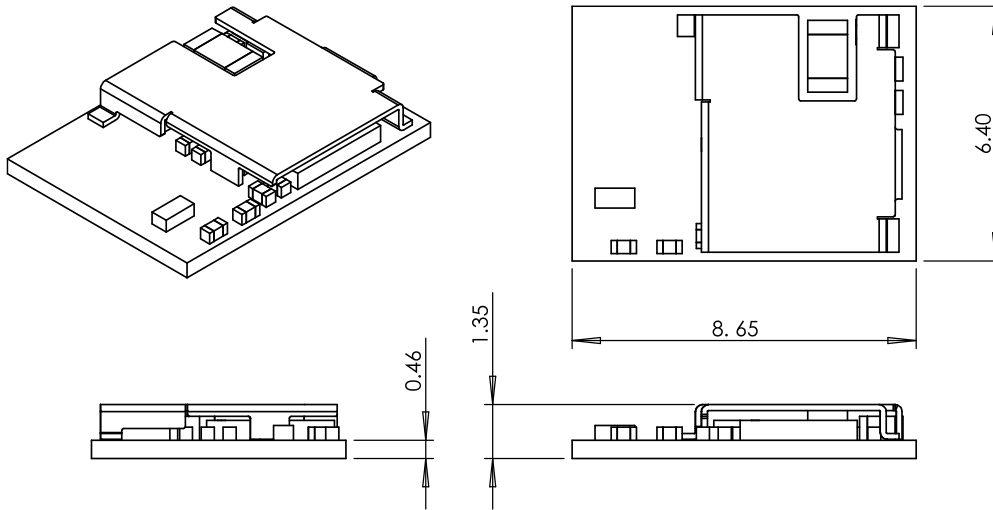

Figure 8 – BMD-350 Module Dimensions

(All dimensions are in mm)

9.2 Recommended PCB Land Pads

9.2.1 BMD-300/301

The BMD-300 and BMD-301 have identical PCB layout footprints. **Note:** RF keep-out not required when using the BMD-301.

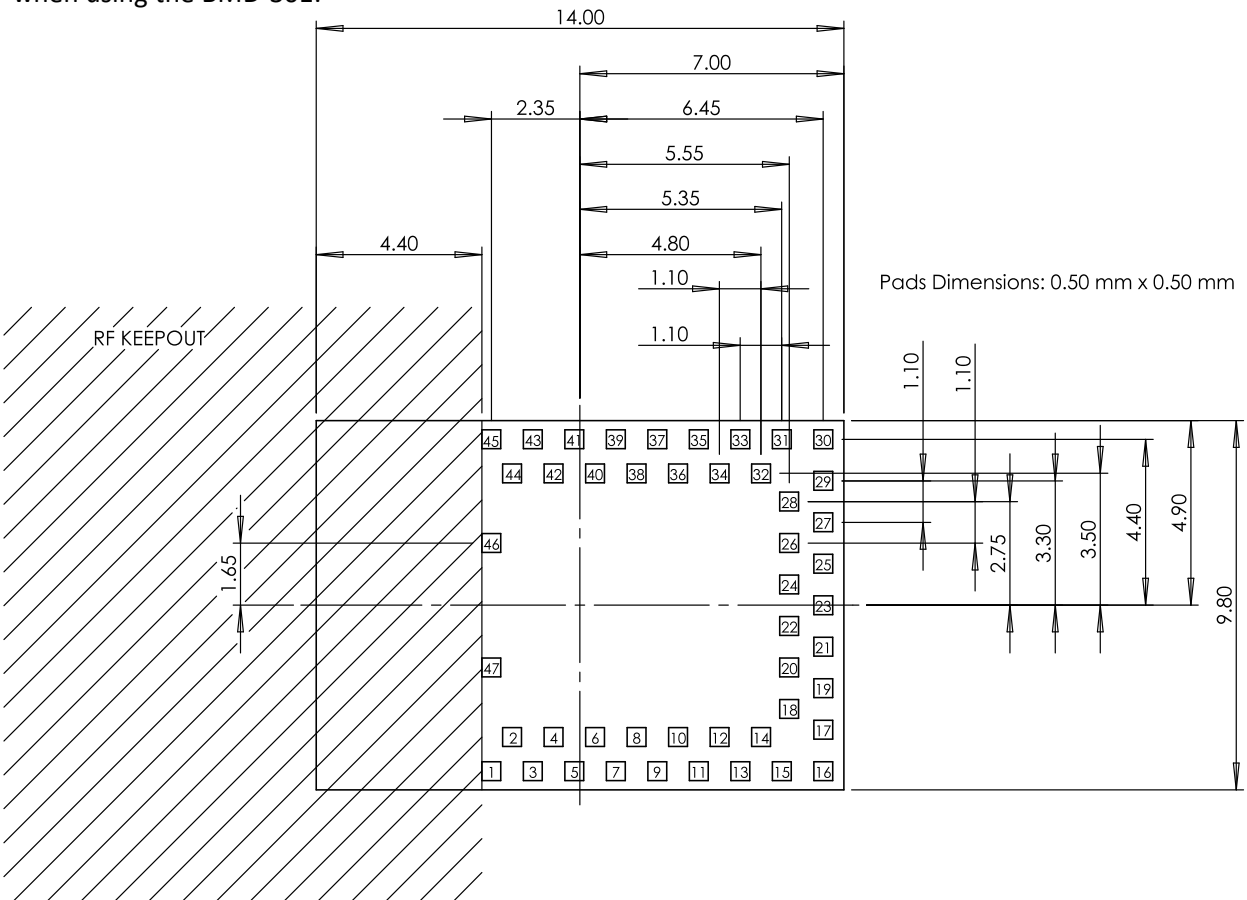

Figure 9 – BMD-300/301 Dimensions (Top View)

(All dimensions are in mm)

9.2.2 BMD-350

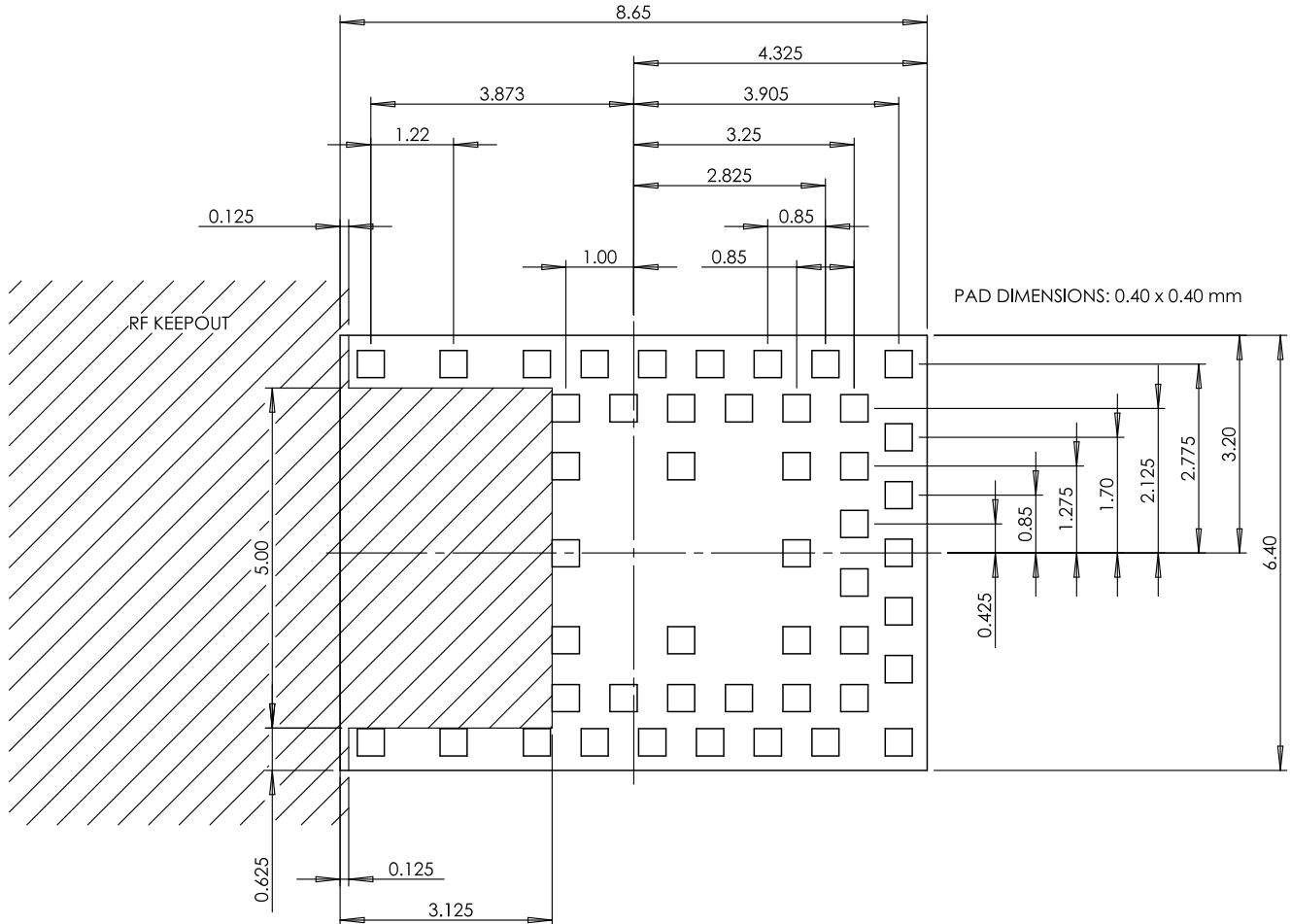

Figure 10 – BMD-350 Dimensions (Top View)
(All dimensions are in mm)

10. Module Marking

10.1 BMD-300 Module Marking

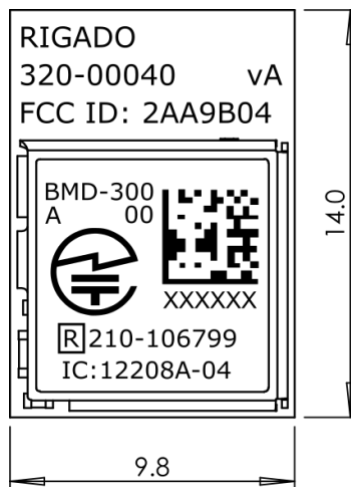

Figure 11 – BMD-300 Module Marking – Rev A

11. RF Design Notes

11.1 Recommended RF Layout & Ground Plane

11.1.1 BMD-300

For the BMD-300, the integrated antenna requires a suitable ground plane to radiate effectively. The area under and extending out from the antenna portion of the module should be kept clear of copper and other metal. The module should be placed at the edge of the PCB with the antenna edge facing out. Reducing the ground plane from that shown in Figure 14 will reduce the effective radiated power. For example, a 27mm x 29mm board (about the size of a coin cell) has approximately 3dB lower output than the BMD-300 Evaluation Board.

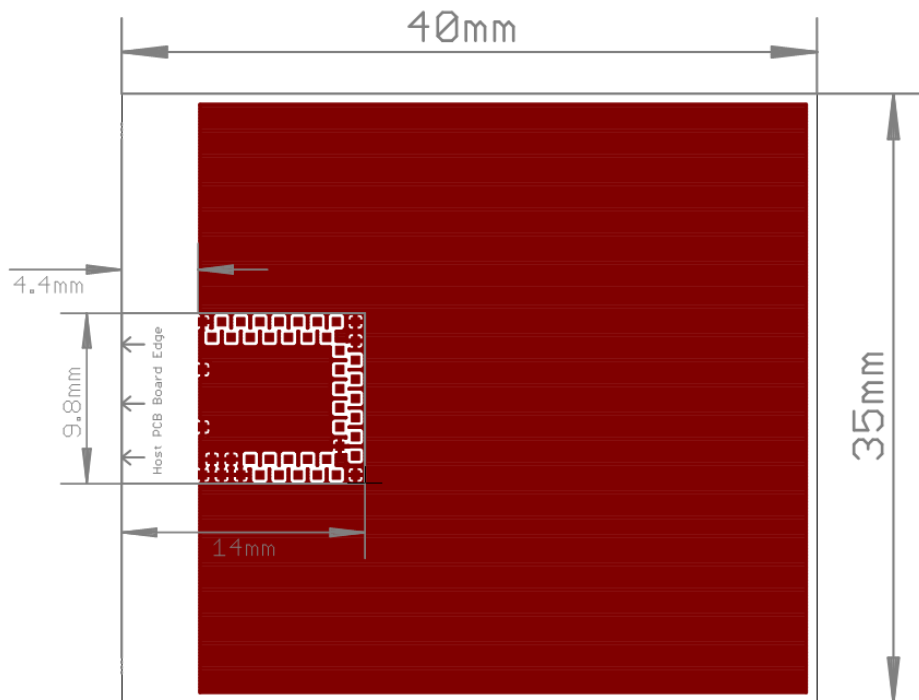

Figure 14 – BMD-300 Recommended RF Layout

11.1.2 BMD-301

For the BMD-301, refer to the external antenna datasheet for antenna placement and grounding recommendations.

11.1.3 BMD-350

For the BMD-350, the integrated chip antenna requires a suitable ground plane to radiate effectively. The area under and extending out from the antenna portion of the module should be kept clear of copper and other metal. The module should be placed at the edge of the PCB with the antenna edge facing out.

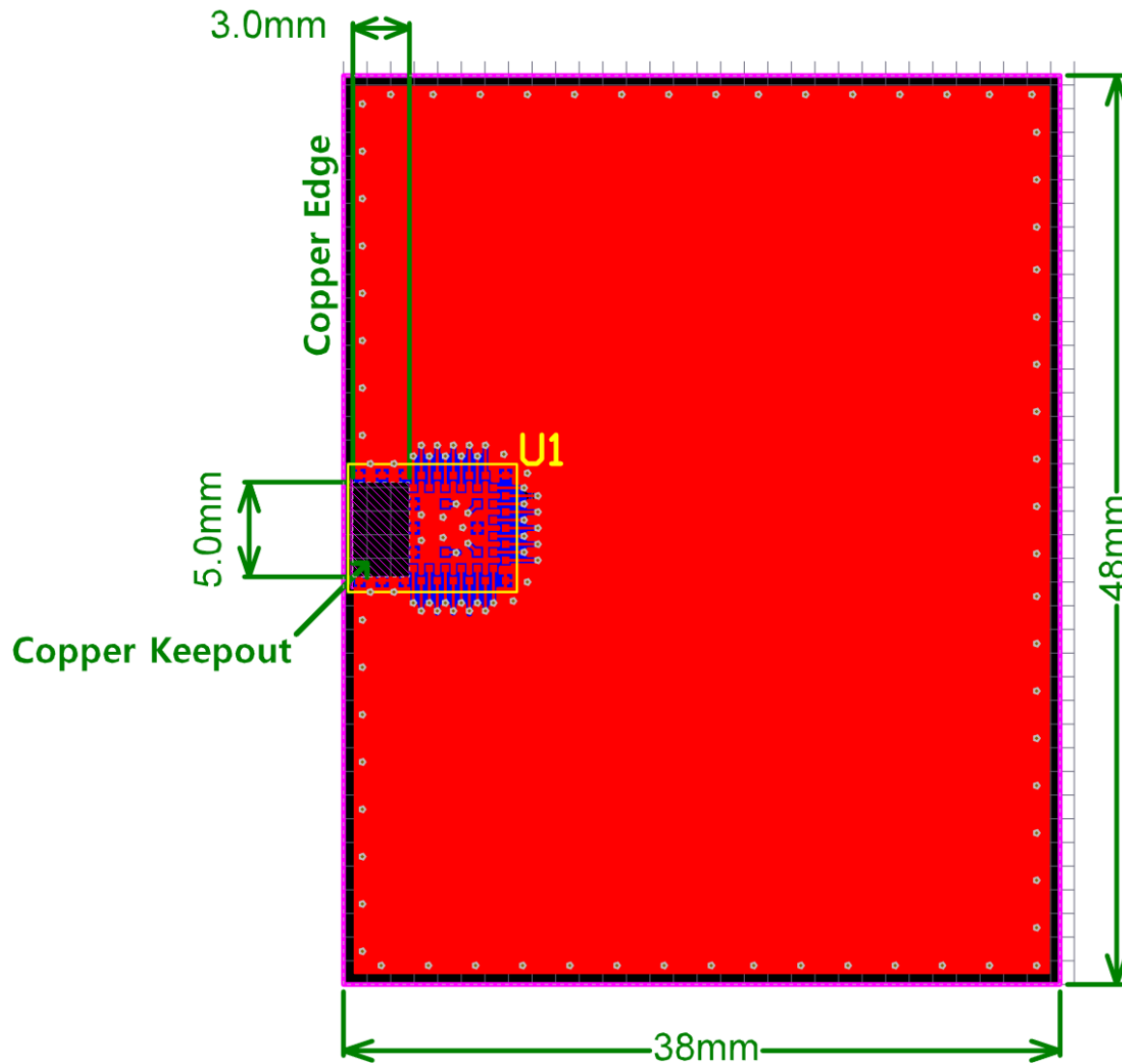

Figure 15 – BMD-350 Recommended RF Layout

11.2 Mechanical Enclosure

For the BMD-300 and BMD-350, care should be taken when designing and placing the module into an enclosure. Metal should be kept clear from the antenna area, both above and below. Any metal around the module can negatively impact RF performance.

The module is designed and tuned for the antenna and RF components to be in free air. Any potting, epoxy fill, plastic over-molding, or conformal coating can negatively impact RF performance and must be evaluated by the customer.

For the BMD-301, refer to the external antenna datasheet for placement in or on a mechanical enclosure.

11.3 Antenna Patterns

11.3.1 BMD-300

Antenna patterns are based on the BMD-300 Evaluation Kit vA with a ground plane size of 82mm x 56mm. X-Y-Z orientation is shown in Figure 16:

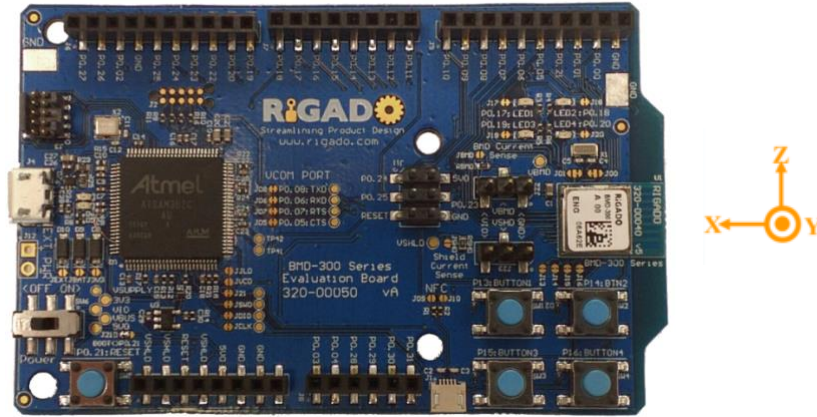

Figure 16 – X-Y-Z Antenna Orientation

11.3.1.1 X-Y Plane

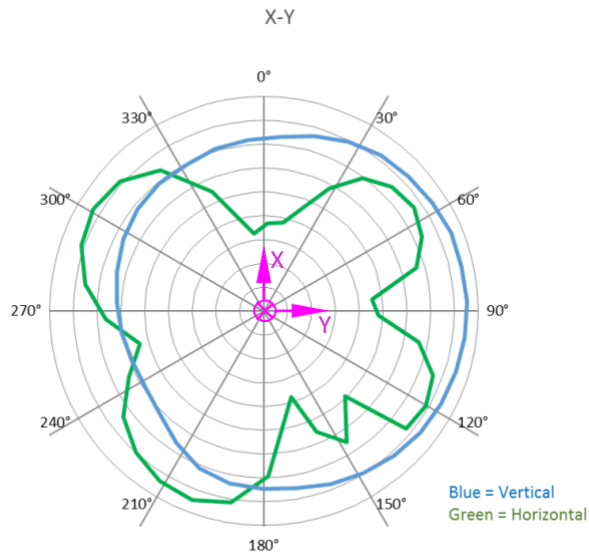
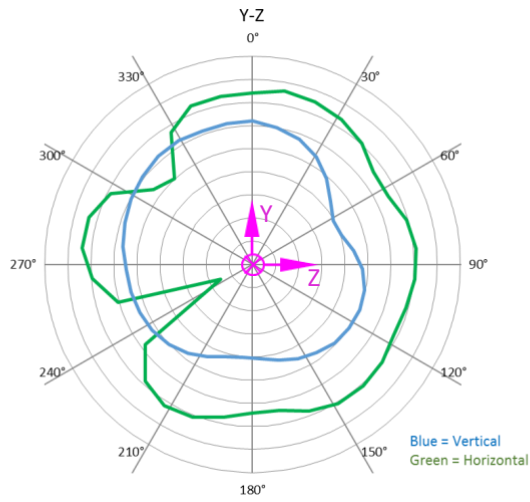
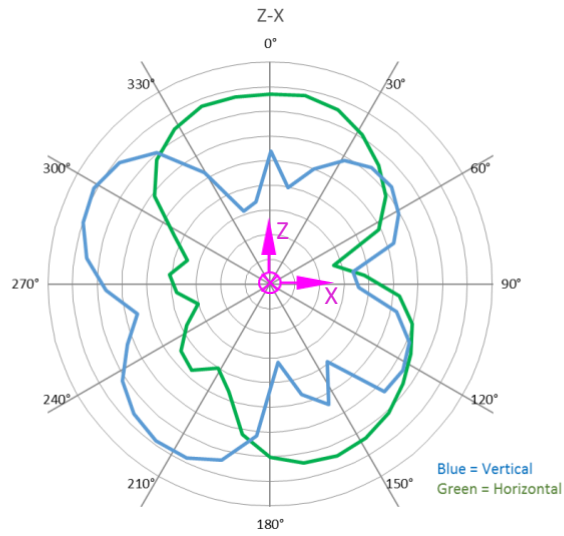
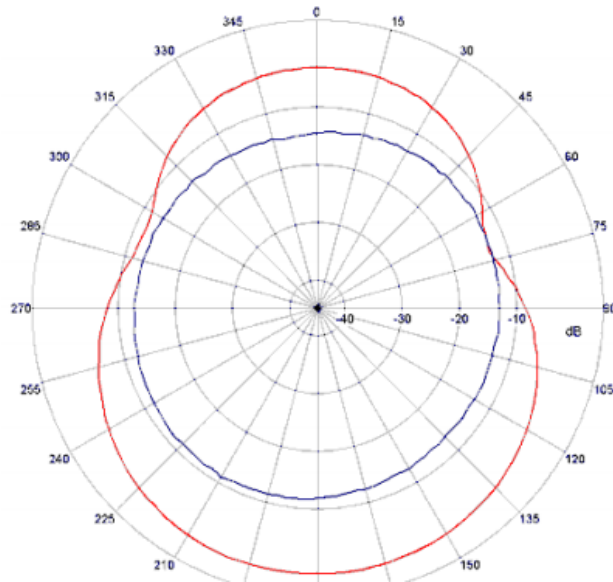
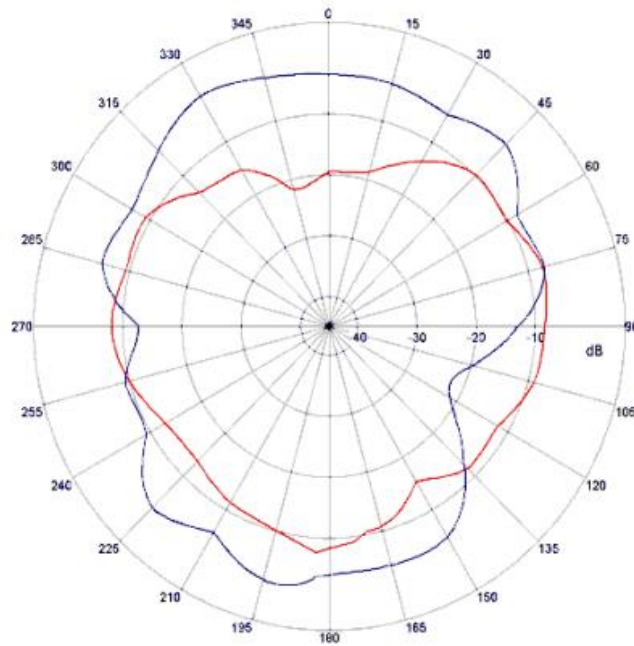

Figure 17 – X-Y Plane Antenna Pattern

11.3.1.2 Y-Z Plane

Figure 18 – Y-Z Plane Antenna Pattern
11.3.1.3 Z-X Plane

Figure 19 – Z-X Plane Antenna Pattern

11.3.2 BMD-350**11.3.2.1 X-Y Plane***Figure 20 – X-Y Plane Antenna Pattern***11.3.2.2 Y-Z Plane***Figure 21 – Y-Z Plane Antenna Pattern*

11.3.2.3 Z-X Plane

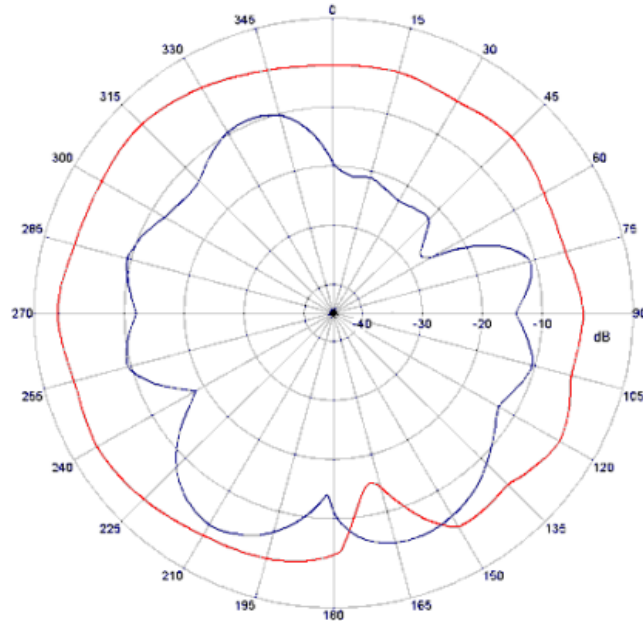

Figure 22 – Z-X Plane Antenna Pattern

12. Evaluation Boards

Rigado has developed full featured evaluation boards that provide a complete I/O pin out to headers, on-board programming and debug, 32.768 kHz crystal, power & virtual COM port over USB, 4 user LEDs, and 4 user buttons. The evaluation boards also provide the option to be powered from a CR2032 coin cell battery, and have current sense resistors and headers to allow for convenient current measurements. An Arduino Uno R3 style header is provided for easy prototyping of additional functions. The evaluation boards also support programming off-board BMD-300 Series modules.

13. Custom Development

Rigado is a full-service design house offering end-to-end product development from concept to manufacturing. We can provide custom modules and do electrical and mechanical design, end product manufacturing, firmware and mobile development, and web and cloud integration. Please contact Rigado at info@rigado.com or 1-866-6-RIGADO for custom engineering options and fees.

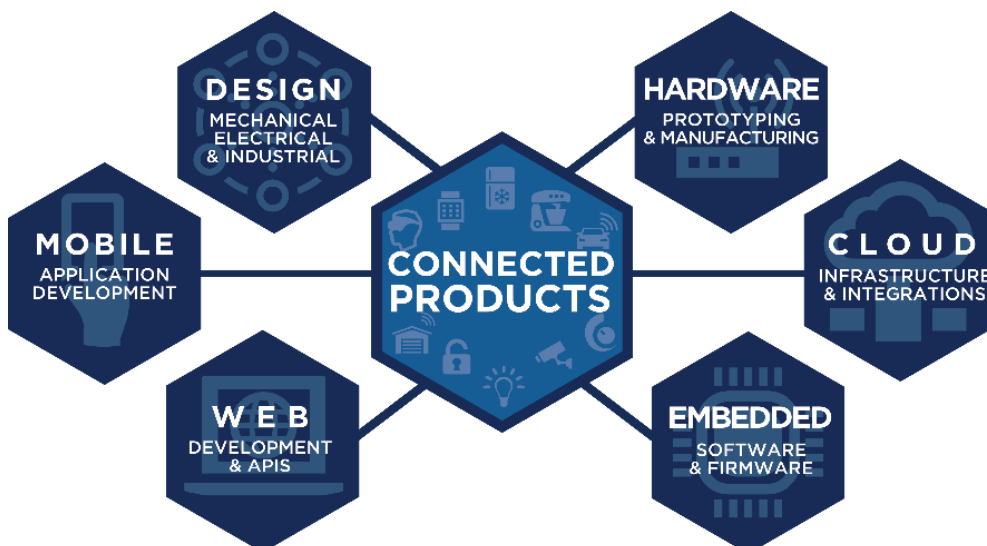

14. Bluetooth Qualification

The BMD-300 Series modules are qualified as a Bluetooth Component (tested) for RF-PHY. This allows customers to use different SoftDevices that have been qualified by Nordic without the need to complete additional RF-PHY testing. To achieve Bluetooth End Product qualification, the Rigado RF-PHY QDID can be combined with Nordic QDIDs for the SoftDevice used when filing on the Bluetooth SIG website. The only testing required is for the Bluetooth profiles supported by the customer's product. Products with only custom profiles do not require any additional testing.

- BMD-300/BMD-301: RF-PHY v4.2 Component(Tested) Declaration ID **D030629** / QDID **81876**
- BMD-300/BMD-301: RF-PHY v5.0 Component(Tested) Declaration ID **D037298** / QDID **101625**
- BMD-350: RF-PHY v4.2 Declaration ID **D036284** / QDID **98865**
- BMD-350: RF-PHY v5.0 Declaration ID **D037181**/ QDID **101018**

15. Regulatory Statements

15.1 FCC Statement:

This device has been tested and found to comply with part 15 of the FCC rules. These limits are designed to provide reasonable protection against harmful interference in a residential installation. This equipment generates, uses and can radiate radio frequency energy and, if not installed and used in accordance with the instructions, may cause harmful interference to radio communications. However, there is no guarantee that interference will not occur in a particular installation. If this equipment does cause harmful interference to radio or television reception, which can be determined by turning the equipment off and on, the user is encouraged to try to correct the interference by one or more of the following measures:

- Reorient or relocate the receiving antenna.
- Increase the separation between the equipment and the receiver
- Connect the equipment into an outlet on a circuit different from that to which the receiver is connected.
- Consult the dealer or an experienced radio/TV technician for help.

Operation is subjected to the following two conditions: (1) This device may no cause harmful interference, and (2) this device must accept any interference received, including interference that may cause undesired operation. Note: Modification to this product will void the user's authority to operate this equipment.

Note: Modification to this product will void the users' authority to operate this equipment.

15.2 FCC Important Notes

(1) FCC Radiation Exposure Statement

This equipment complies with FCC RF radiation exposure limits set forth for an uncontrolled environment. This transmitter must not be co-located or operating in conjunction with any other antenna or transmitter.

This equipment complies with Part 15 of the FCC Rules. Operation is subject the following two conditions:

- (1) This device may not cause harmful interference, and
- (2) This device must accept any interference received, including interference that may cause undesired operation.

The devices must be installed and used in strict accordance with the manufacturer's instructions as described in this document.

Caution!

The manufacturer is not responsible for any radio or TV interference caused by unauthorized modifications to this equipment. Such modification could void the user authority to operate the equipment.

(2) Co-location Warning:

This device and its antenna(s) must not be co-located or operating in conjunction with any other transmitter antenna.

(3) OEM integration instructions :

This device is intended only for OEM integrators under the following conditions:

The antenna and transmitter must not be co-located with any other transmitter or antenna. The module shall be only used with the integral antenna(s) that has been originally tested and certified with this module.

As long as the two (2) conditions above are met, further transmitter testing will not be required. However, the OEM integrator is still responsible for testing their end-product for any additional compliance requirements with this module installed (for example, digital device emission, PC peripheral requirements, etc.)

In the event that these conditions cannot be met (for example certain laptop configuration or co-location with another transmitter), then the FCC authorization for this module in combination with the host equipment is no longer considered valid and the FCC ID of the module cannot be used on the final product. In these and circumstance, the OEM integrator will be responsible for re-evaluating the end product (including the transmitter) and obtaining a separate FCC authorization.

Caution!

The OEM is still responsible for verifying end product compliance with FCC Part 15, subpart B limits for unintentional radiators through an accredited test facility.

(4) End product labeling :

The final end product must be labeled in a visible area with the following:

- BMD-300: "Contains **FCC ID: 2AA9B04**"
- BMD-301: "Contains **FCC ID: 2AA9B04**"
- BMD-350: "Contains **FCC ID: 2AA9B05**"
- Any similar wording that expresses the same meaning may be used.

The FCC Statement below should also be included on the label. When not possible, the FCC Statement should be included in the User Manual of the host device.

"This device complies with part 15 of the FCC rules.

Operation is subject to the following two conditions. (1) This device may not cause harmful interference. (2) This device must accept any interference received, including interference that may cause undesired operation."

(5) Information regarding the end user manual :

The OEM integrator has to be aware not to provide information to the end user regarding how to install or remove this RF module in the user's manual of the end product which integrates this module. The end user manual shall include all required regulatory information/warning as show in this manual (Section 15.2(4)).

15.3 IC (ISED) Statement:

This device complies with Industry Canada license-exempt RSS standard(s). Operation is subject to the following two conditions: (1) this device may not cause interference, and (2) this device must accept any interference, including interference that may cause undesired operation of the device.

Le présent appareil est conforme aux CNR d'Industrie Canada applicables aux appareils radio exempts de licence. L'exploitation est autorisée aux deux conditions suivantes : (1) l'appareil ne doit pas produire de brouillage, et (2) l'utilisateur de l'appareil doit accepter tout brouillage radioélectrique subi, même si le brouillage est susceptible d'en compromettre le fonctionnement.

RF exposure warning: The equipment complies with RF exposure limits set forth for an uncontrolled environment. The antenna(s) used for this transmitter must not be co-located or operating in conjunction with any other antenna or transmitter.

Avertissement d'exposition RF: L'équipement est conforme aux limites d'exposition aux RF établies pour un incontrôlé environnement. L'antenne (s) utilisée pour ce transmetteur ne doit pas être co-localisés ou fonctionner en conjonction avec toute autre antenne ou transmetteur .

15.4 IC (ISED) Important Notes

1. The OEM integrator must be aware not to provide information to the end user regarding how to install or remove this RF module in the user manual of the end product.

The user manual which is provided by OEM integrators for end users must include the following information in a prominent location.

2. To comply with IC RF exposure compliance requirements, the antenna used for this transmitter must not be co-located or operating in conjunction with any other antenna or transmitter, except in accordance with IC multi-transmitter product procedures.

3. The final system integrator must ensure there is no instruction provided in the user manual or customer documentation indicating how to install or remove the transmitter module except such device has implemented two-ways authentication between module and the host system.

4. The host device shall be properly labelled to identify the module within the host device. The end product must be labeled in a visible area with the following:

- BMD-300: "Contains IC: **12208A-04**"
- BMD-301: "Contains IC: **12208A-04**"
- BMD-350: "Contains IC: **12208A-05**"

Any similar wording that expresses the same meaning may be used.

The IC Statement below should also be included on the label. When not possible, the IC Statement should be included in the User Manual of the host device.

"This device complies with Industry Canada license-exempt RSS standard(s). Operation is subject to the following two conditions: (1) this device may not cause interference, and (2) this device must accept any interference, including interference that may cause undesired operation of the device.

Le présent appareil est conforme aux CNR d'Industrie Canada applicables aux appareils radio exempts de licence. L'exploitation est autorisée aux deux conditions suivantes : (1) l'appareil ne doit pas produire de brouillage, et (2) l'utilisateur de l'appareil doit accepter tout brouillage radioélectrique subi, même si le brouillage est susceptible d'en compromettre le fonctionnement."

15.5 CE Regulatory

The BMD-300 Series modules are tested and compliant against the following standards. OEM integrators should consult with qualified test house to verify all regulatory requirements have been met for their complete device.

From Radio Equipment Directive 2014/53/EU:

- EN 60950-1: 2006 + A11: 2009 + A1: 2010 + A12: 2011
- ETSI EN 300 328 V 2.1.1
- ETSI EN 301 489-1 V2.1.1
- ETSI EN 301 489-17 V3.1.1

Declarations of Conformity and supporting test reports are available at www.rigado.com.

15.6 Japan (MIC)

The BMD-300 Series modules have received type certification and is labeled with its own technical conformity mark and certification number as required to conform to the technical standards regulated by the Ministry of Internal Affairs and Communications (MIC) of Japan pursuant to the Radio Act of Japan. Integration of this module into a final end product does not require additional radio certification provided installation instructions are followed and no modifications of the module are allowed. Additional testing may be required:

- If the host product is subject to electrical appliance safety (for example, powered from an AC mains), the host product may require Product Safety Electrical Appliance and Material (PSE) testing. The integrator should contact their conformance laboratory to determine if this testing is required.
- There is a voluntary Electromagnetic Compatibility (EMC) test for the host product administered by VCCI: http://www.vcci.jp/vcci_e/index.html

The label on the end product which contains a BMD-300 Series module must follow the MIC marking requirements. Labeling requirements for Japan available at the Ministry of Internal Affairs and Communications (MIC) website: <http://www.tele.soumu.go.jp/e/index.htm>.

The BMD-300 module is labeled with its assigned technical conformity mark and certification number. The end product in which this module is being used must have an external label referring to the type certified module inside:

Contains transmitter module with certificate number:

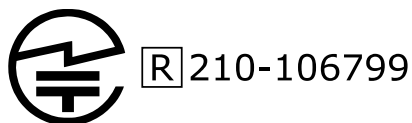

The BMD-301 module is labeled with its assigned technical conformity mark and certification number. The end product in which this module is being used must have an external label referring to the type certified module inside:

Contains transmitter module with certificate number:

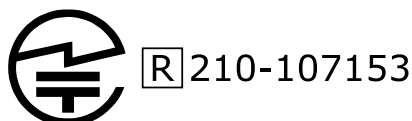

The BMD-350 module is assigned a technical conformity mark and certification number. The end product in which this module is being used must have an external label referring to the type certified module inside:

Contains transmitter module with certificate number:

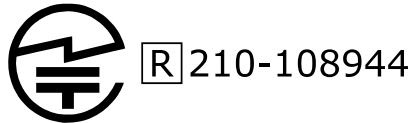

15.7 Australia / New Zealand

The BMD-300 Series modules have been tested to comply with the AS/NZS 4268 :2012+AMDT 1:2013, Radio equipment and systems – Short range devices – Limits and methods of measurement. The report may be downloaded from www.rigado.com, and may be used as evidence in obtaining permission to use the RCM. Information on registration as a Responsible Party, license and labeling requirements may be found at the following websites:

Australia: <http://www.acma.gov.au/theACMA/radiocommunications-short-range-devices-standard-2004>

New Zealand: <http://www.rsm.govt.nz/compliance>

The A-Tick and C-Tick marks are being migrated to the Regulatory Compliance Mark (RCM). Only Australian-based and New Zealand-based companies who are registered may be granted permission to use the RCM. An Australian-based or New Zealand-based agent or importer may also register as a Responsible Party to use the RCM on behalf of a company not in Australia or New Zealand.

15.8 Approved External Antennas

The antennas listed below were tested for use with the BMD-301.

#	Manufacturer	Part Number	Max Gain	Type	Size	Approvals
1	Pulse	W1030	2 dBi	1/4 Wave Dipole – Whip	Length: 108.3mm	FCC, IC, MIC
2	Taoglas	FXP73.07.0100A	2.5dBi	1/4 Wave Dipole – Flex	7mm x 47mm x 0.1mm	FCC, IC, MIC
3	Pulse	W1027	3.2 dBi	1/4 Wave Dipole – Whip	Length: 136.8mm	FCC, IC, MIC
4	Kinsun	6670113050-145	2.0 dBi	1/4 Wave Dipole – PCB	12mm x 65mm x 0.46mm	FCC, IC, MIC
5	Kinsun	6610103081	5.0 dBi	1/2 Wave Dipole – Whip	Length: 196.6mm	FCC, IC, MIC

Table 12 - Approved External Antennas

15.9 BMD-350 Module Labeling

Due to the extreme size constraints, the FCC, IC, and MIC have granted an exemption for the BMD-350 module from requiring the FCC ID, IC number, and Japan Certification number and mark to be physically located on the module. However, the host product is still required to affix the FCC ID: 2AA9B05, IC: 12208A-05, and Japan Certificate 210-108944 (as applicable) to the outside of the host product and in the host product user manual. See Section 5.2 FCC Important Notes, Section 5.4 IC Important Notes, and Section 5.6 Japan (MIC) for host product and user manual labeling instructions.

16. Solder Reflow Temperature-Time Profile

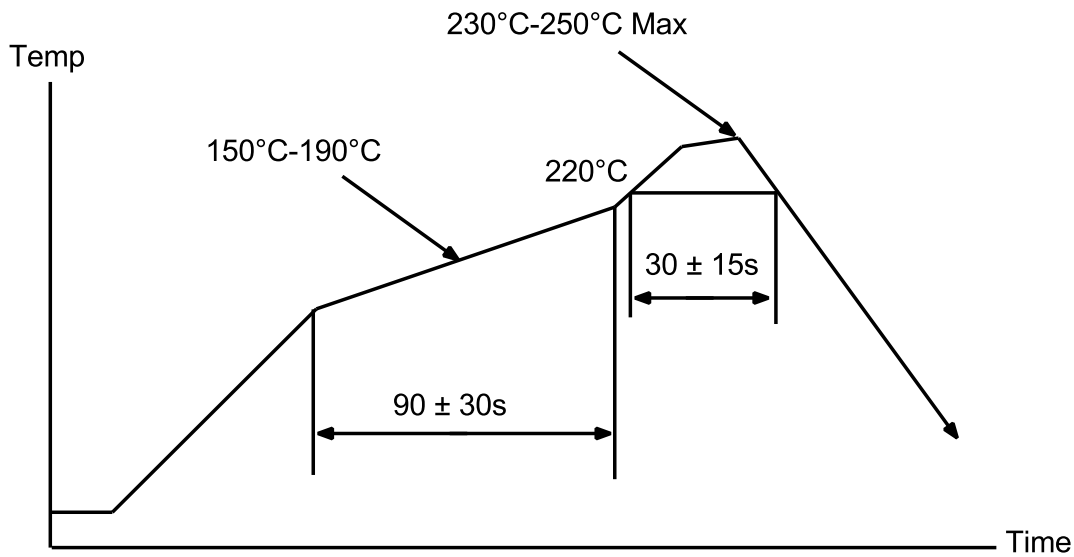

Figure 23 – Reflow Profile for Lead Free Solder

16.1 Moisture Sensitivity Level

The BMD-300 Series is rated for MSL 3, 168-hour floor life after opening.

17. Packaging and Labeling

17.1 Carrier Tape Dimensions

17.1.1 BMD-300 & BMD-301

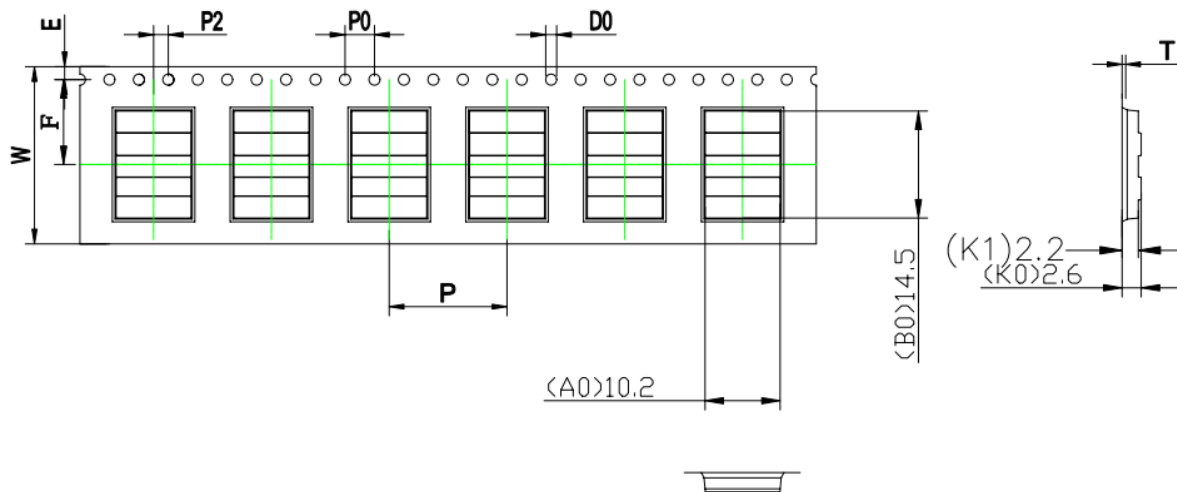

ITEM	W	A ₀	B ₀	K ₀	K ₁	P	F	E	D ₀	D ₁	P ₀	P ₂	T
DIM	24.0 ^{+0.30} _{-0.30}	10.2 ^{+0.10} _{-0.10}	14.5 ^{+0.10} _{-0.10}	2.6 ^{+0.10} _{-0.10}	2.2 ^{+0.00} _{-0.00}	16.0 ^{+0.10} _{-0.10}	11.5 ^{+0.10} _{-0.10}	1.75 ^{+0.10} _{-0.10}	1.50 ^{+0.10} _{-0.00}	0.00 ^{+0.10} _{-0.00}	4.00 ^{+0.10} _{-0.10}	2.00 ^{+0.10} _{-0.10}	0.30 ^{+0.05} _{-0.05}
ALTERNATE													

Figure 24 – BMD-300/301 Carrier Tape Dimensions

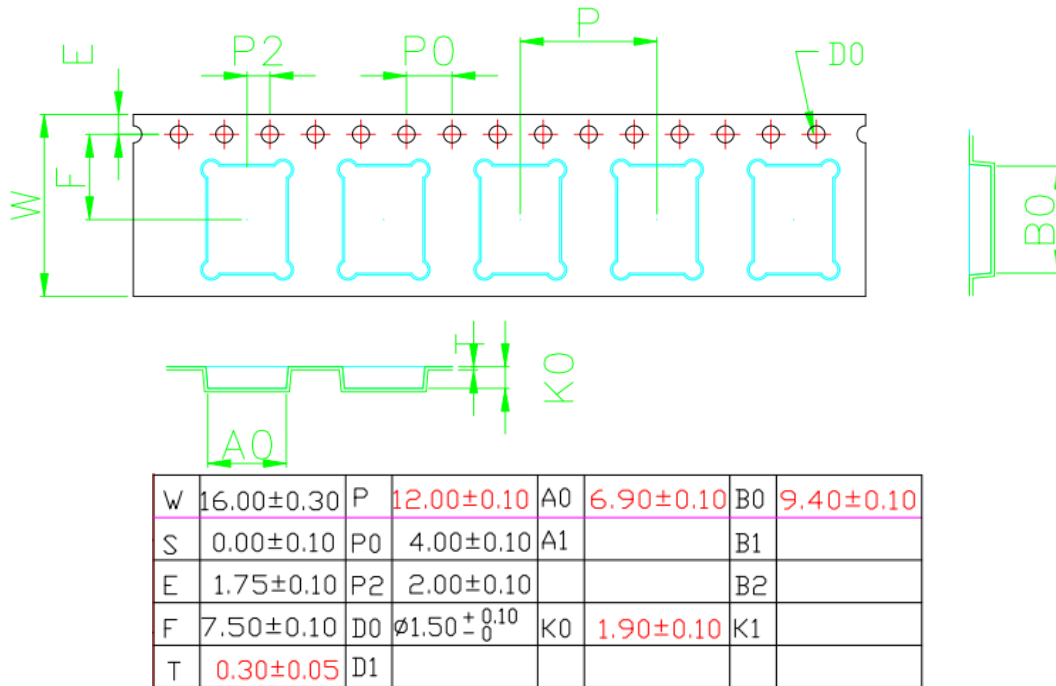
17.1.2 BMD-350

Figure 25 – BMD-350 Carrier Tape Dimensions
17.2 Reel Packaging

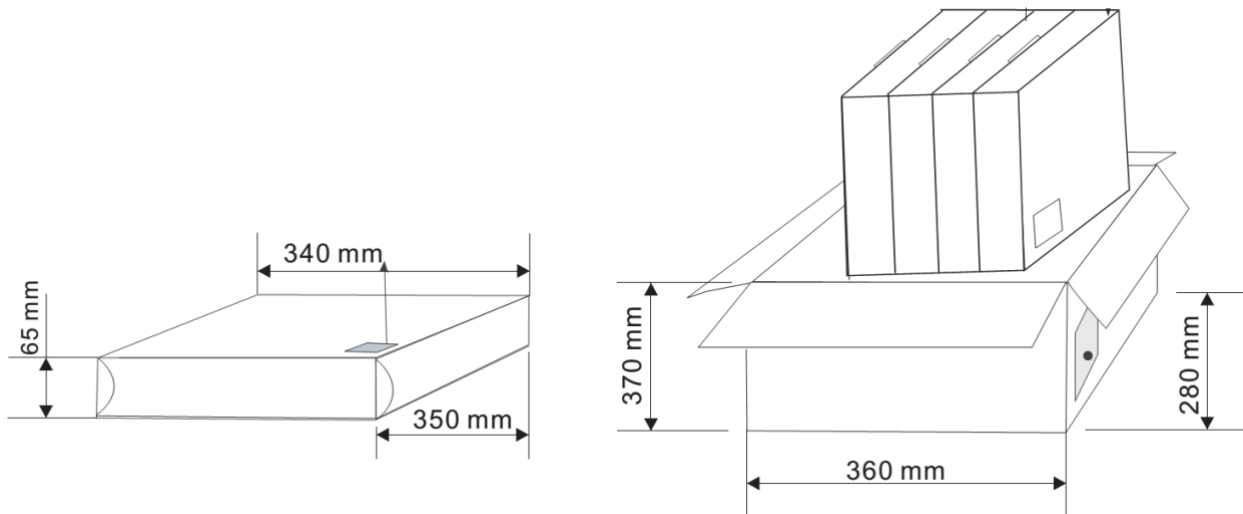
Modules come on 330mm reels loaded with 1000 modules. Each reel is placed in an antistatic bag with a desiccant pack and humidity card and placed in a 340x350x65mm box. On the outside of the bag an antistatic warning and reel label are adhered.

Figure 26 – Reel Cartons

17.3 Packaging Label

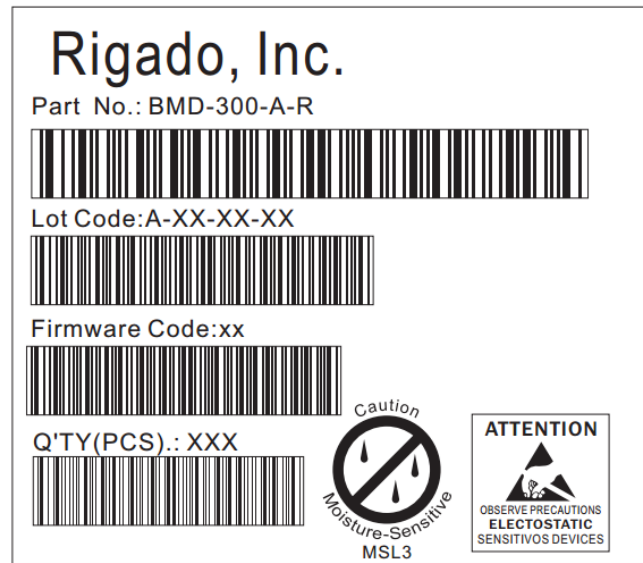

Figure 27 – Packaging Label

18. Cautions

- 1) The guidelines of this document should be followed in order to assure proper performance of the module.
- 2) This product is for use in office, business, and residential applications, but not medical devices.
- 3) This module may short-circuit. If a short circuit can result in serious damage or injury then failsafe precautions should be used. This could be accomplished by redundant systems and protection circuits.
- 4) Supply voltage to the module should not be higher than the specified inputs or reversed. Additionally, it should not contain noise, spikes, or AC ripple voltage.
- 5) Avoid use with other high frequency circuits.
- 6) Use methods to eliminate static electricity when working with the module as it can damage the components.
- 7) Contact with wires, the enclosure, or any other objects should be avoided.
- 8) Refer to the recommended pattern when designing for this module.
- 9) If hand soldering is used, be sure to use the precautions outlined in this document.
- 10) This module should be kept away from heat, both during storage and after installation.
- 11) Do not drop or physically shock the module.
- 12) Do not damage the interface surfaces of the module.
- 13) The module should not be mechanically stressed at any time (storage, handling, installation).
- 14) Do not store or expose this module to:
 - Humid or salty air conditions
 - High concentrations of corrosive gasses.
 - Long durations of direct sunlight.
 - Temperatures lower than -40°C or higher than 125°C.

19. Life Support Policy

This product is not designed to be used in a life support device or system, or in applications where there is potential for a failure or malfunction to, directly or indirectly, cause significant injury. By using this product in an application that poses these risks, such as described above, the customer is agreeing to indemnify Rigado for any damages that result.

20. Document History

Revision	Date	Changes / Notes
0.8	11/06/2015	Initial preliminary release
0.8.1	11/10/2015	Updated Table 5, Figure 5, Section 7.5. Corrected antenna references
0.8.2	11/11/2015	Updated Figure 1
0.8.3	11/20/2015	Updated current ratings from nRF52832 OPC v0.6.3. Corrected Table 3
0.9	3/17/2016	Added BMD-301, GPIO notes, MSL, updated certifications, updated electrical specifications
0.9.4	3/23/2016	Added BMD-301 antennas
1.0	5/04/2016	Production Release; removed pending for FCC, Japan (MIC), & Bluetooth
1.1	5/20/2016	Removed pending for IC, MIC (BMD-301)
1.2	6/03/2016	Added Factory Firmware Version AB information
1.3	6/06/2016	Updated Module Programming and Read-Back Protection section
1.4	7/07/2016	Added preliminary information for the BMD-350
1.5	7/28/2016	Added RigDFU and BMDware pin numbers, corrected nRF52832 PS link
1.6	8/10/2016	Corrected RESET pin number on BMD-350
1.7	11/10/2016	Updated layout drawings, added more BMD-350 data + certs
1.8	12/2/2016	Added BMD-350 Japan certificate number
1.9	8/10/2017	Add RED for BMD-300, BMD-301, BMD-350; BT DID for BMD-350, Factory Firmware AD
1.10	9/29/2017	Added Bluetooth 5 QDIDs, Factory Firmware AE
1.11	1/24/2018	Added firmware notices in Firmware, RigDFU pin-out and BMDware pin-out sections

21. Related Documents

Rigado Documents:

- BMD-300-Series-EVAL-UG: Evaluation Kit User Guide
- RIGDFU-DS: RigDFU Secure Bootloader Datasheet
- BMDWARE-DS: BMDware Datasheet

Nordic Documents:

Visit infocenter.nordicsemi.com for a comprehensive library of Nordic technical documentation.

- nRF52832 – [nRF52832 Product Specification](#)
- S132-SDS – [nRF52832 S132 Soft Device Specification](#)
- S212-SDS – [nRF52832 S212 Soft Device Specification](#)
- S332-SDS – [nRF52832 S332 Soft Device Specification](#)



Компания «ЭлектроПласт» предлагает заключение долгосрочных отношений при поставках импортных электронных компонентов на взаимовыгодных условиях!

Наши преимущества:

- Оперативные поставки широкого спектра электронных компонентов отечественного и импортного производства напрямую от производителей и с крупнейших мировых складов;
- Поставка более 17-ти миллионов наименований электронных компонентов;
- Поставка сложных, дефицитных, либо снятых с производства позиций;
- Оперативные сроки поставки под заказ (от 5 рабочих дней);
- Экспресс доставка в любую точку России;
- Техническая поддержка проекта, помощь в подборе аналогов, поставка прототипов;
- Система менеджмента качества сертифицирована по Международному стандарту ISO 9001;
- Лицензия ФСБ на осуществление работ с использованием сведений, составляющих государственную тайну;
- Поставка специализированных компонентов (Xilinx, Altera, Analog Devices, Intersil, Interpoint, Microsemi, Aeroflex, Peregrine, Syfer, Eurofarad, Texas Instrument, Miteq, Cobham, E2V, MA-COM, Hittite, Mini-Circuits, General Dynamics и др.);

Помимо этого, одним из направлений компании «ЭлектроПласт» является направление «Источники питания». Мы предлагаем Вам помощь Конструкторского отдела:

- Подбор оптимального решения, техническое обоснование при выборе компонента;
- Подбор аналогов;
- Консультации по применению компонента;
- Поставка образцов и прототипов;
- Техническая поддержка проекта;
- Защита от снятия компонента с производства.



Как с нами связаться

Телефон: 8 (812) 309 58 32 (многоканальный)

Факс: 8 (812) 320-02-42

Электронная почта: org@eplast1.ru

Адрес: 198099, г. Санкт-Петербург, ул. Калинина, дом 2, корпус 4, литера А.