

1 - Cathode
2 - Anode
Back of Case - Cathode

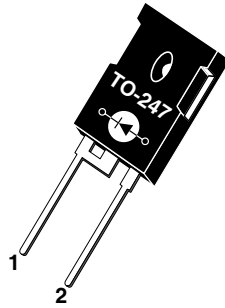

APT100S20B(G) 200V 120A

*G Denotes RoHS Compliant, Pb Free Terminal Finish.

HIGH VOLTAGE SCHOTTKY DIODE

PRODUCT APPLICATIONS	PRODUCT FEATURES	PRODUCT BENEFITS
<ul style="list-style-type: none"> • Parallel Diode <ul style="list-style-type: none"> -Switchmode Power Supply -Inverters • Free Wheeling Diode <ul style="list-style-type: none"> -Motor Controllers -Converters • Snubber Diode • Uninterruptible Power Supply (UPS) • 48 Volt Output Rectifiers • High Speed Rectifiers 	<ul style="list-style-type: none"> • Ultrafast Recovery Times • Soft Recovery Characteristics • Popular TO-247 Package or Surface Mount D²PAK Package • Low Forward Voltage • High Blocking Voltage • Low Leakage Current 	<ul style="list-style-type: none"> • Low Losses • Low Noise Switching • Cooler Operation • Higher Reliability Systems • Increased System Power Density

MAXIMUM RATINGS

All Ratings: $T_C = 25^\circ\text{C}$ unless otherwise specified.

Symbol	Characteristic / Test Conditions	APT100S20B(G)	UNIT
V_R	Maximum D.C. Reverse Voltage	200	Volts
V_{RRM}	Maximum Peak Repetitive Reverse Voltage		
V_{RWM}	Maximum Working Peak Reverse Voltage		
$I_{F(AV)}$	Maximum Average Forward Current ^① ($T_C = 125^\circ\text{C}$, Duty Cycle = 0.5)	120	Amps
$I_{F(RMS)}$	RMS Forward Current (Square wave, 50% duty) ^①	318	
I_{FSM}	Non-Repetitive Forward Surge Current ($T_J = 45^\circ\text{C}$, 8.3ms)	1000	
T_J, T_{STG}	Operating and Storage Temperature Range	-55 to 150	$^\circ\text{C}$
T_L	Lead Temperature for 10 Sec.	300	
E_{VAL}	Avalanche Energy (2A, 50mH)	100	

STATIC ELECTRICAL CHARACTERISTICS

Symbol		MIN	TYP	MAX	UNIT
V_F	Forward Voltage	$I_F = 100\text{A}$.89	.95	Volts
		$I_F = 200\text{A}$	1.06		
		$I_F = 100\text{A}, T_J = 125^\circ\text{C}$.76		
I_{RM}	Maximum Reverse Leakage Current	$V_R = 200\text{V}$		2	mA
		$V_R = 200\text{V}, T_J = 125^\circ\text{C}$		40	
C_T	Junction Capacitance, $V_R = 200\text{V}$		470		pF

Symbol	Characteristic	Test Conditions	MIN	TYP	MAX	UNIT
t_{rr}	Reverse Recovery Time	$I_F = 100A, di_F/dt = -200A/\mu s$ $V_R = 133V, T_C = 25^\circ C$	-	70		ns
Q_{rr}	Reverse Recovery Charge		-	230		nC
I_{RRM}	Maximum Reverse Recovery Current		-	6	-	Amps
t_{rr}	Reverse Recovery Time	$I_F = 100A, di_F/dt = -200A/\mu s$ $V_R = 133V, T_C = 125^\circ C$	-	110		ns
Q_{rr}	Reverse Recovery Charge		-	690		nC
I_{RRM}	Maximum Reverse Recovery Current		-	11	-	Amps
t_{rr}	Reverse Recovery Time	$I_F = 100A, di_F/dt = -700A/\mu s$ $V_R = 133V, T_C = 125^\circ C$	-	95		ns
Q_{rr}	Reverse Recovery Charge		-	1750		nC
I_{RRM}	Maximum Reverse Recovery Current		-	32		Amps

THERMAL AND MECHANICAL CHARACTERISTICS

Symbol	Characteristic / Test Conditions	MIN	TYP	MAX	UNIT
$R_{\theta JC}$	Junction-to-Case Thermal Resistance			.18	$^\circ C/W$
W_T	Package Weight		0.22		oz
			5.9		g
Torque	Maximum Mounting Torque			10	lb•in
				1.1	N•m

Microsemi reserves the right to change, without notice, the specifications and information contained herein.

① Continuous current limited by package lead temperature.

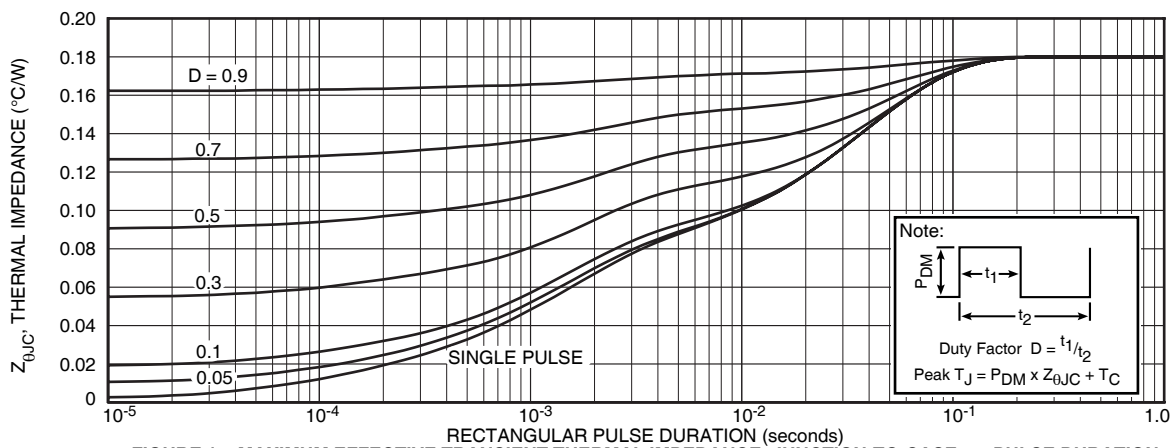

FIGURE 1a. MAXIMUM EFFECTIVE TRANSIENT THERMAL IMPEDANCE, JUNCTION-TO-CASE vs. PULSE DURATION

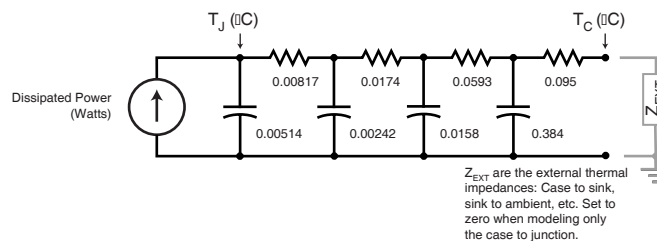

FIGURE 1b. TRANSIENT THERMAL IMPEDANCE MODEL

TYPICAL PERFORMANCE CURVES

APT100S20B(G)

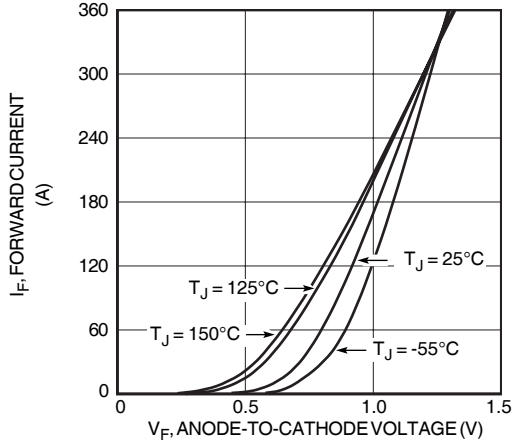

Figure 2. Forward Current vs. Forward Voltage

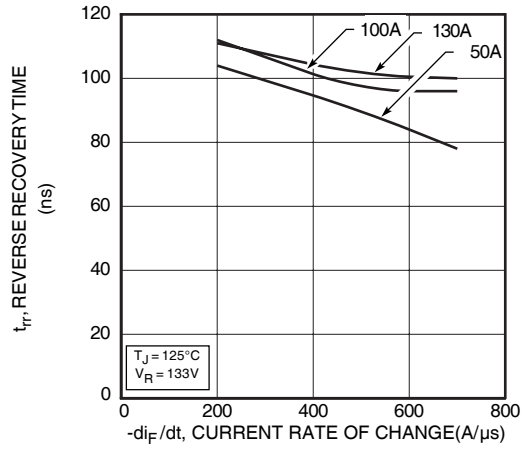

Figure 3. Reverse Recovery Time vs. Current Rate of Change

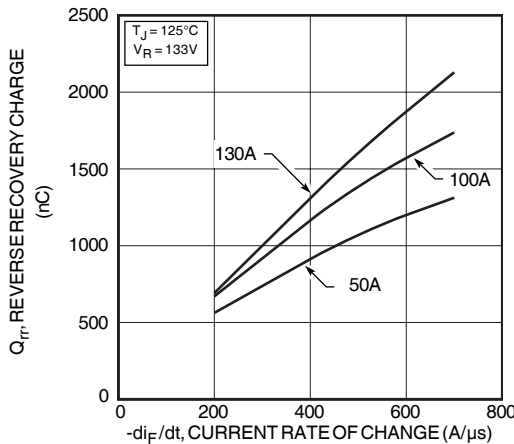

Figure 4. Reverse Recovery Charge vs. Current Rate of Change

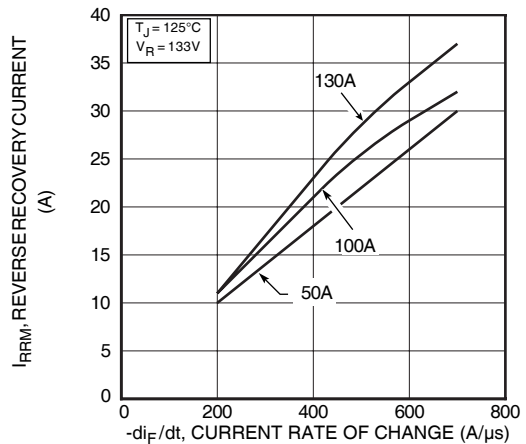

Figure 5. Reverse Recovery Current vs. Current Rate of Change

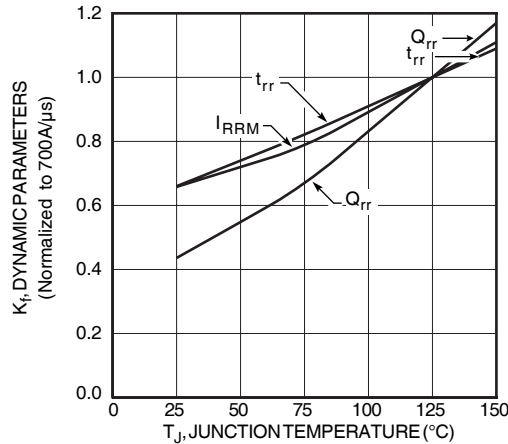

Figure 6. Dynamic Parameters vs. Junction Temperature

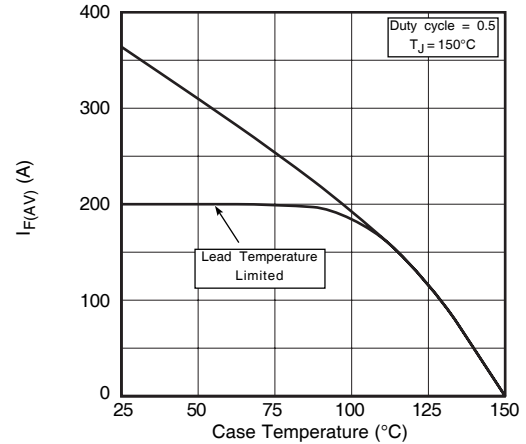

Figure 7. Maximum Average Forward Current vs. Case Temperature

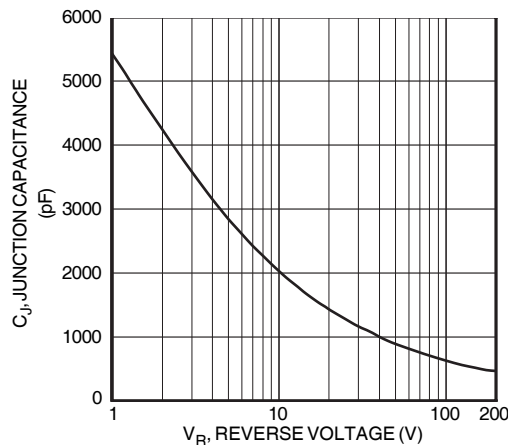

Figure 8. Junction Capacitance vs. Reverse Voltage

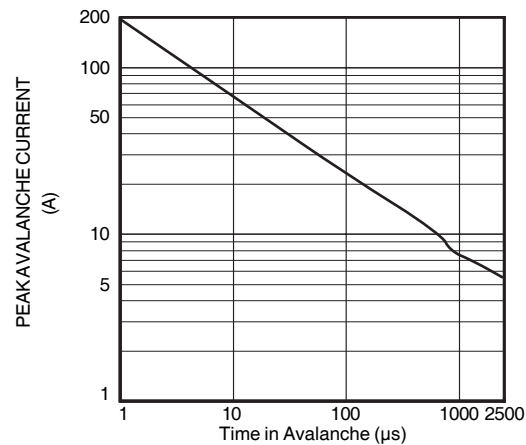

Figure 9. Single Pulse UIS SOA

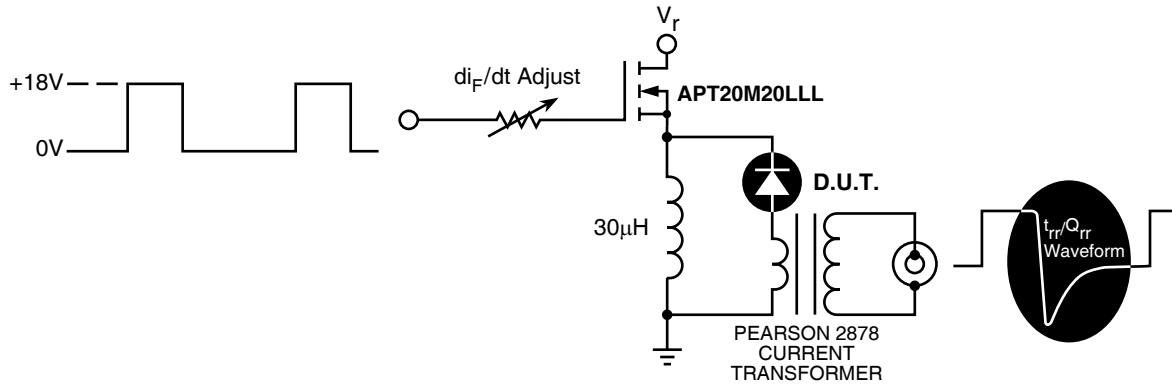

Figure 9. Diode Test Circuit

- 1 I_F - Forward Conduction Current
- 2 di_F/dt - Rate of Diode Current Change Through Zero Crossing.
- 3 I_{RRM} - Maximum Reverse Recovery Current.
- 4 t_{rr} - Reverse Recovery Time, measured from zero crossing where diode current goes from positive to negative, to the point at which the straight line through I_{RRM} and $0.25 \cdot I_{RRM}$ passes through zero.
- 5 Q_{rr} - Area Under the Curve Defined by I_{RRM} and t_{rr} .

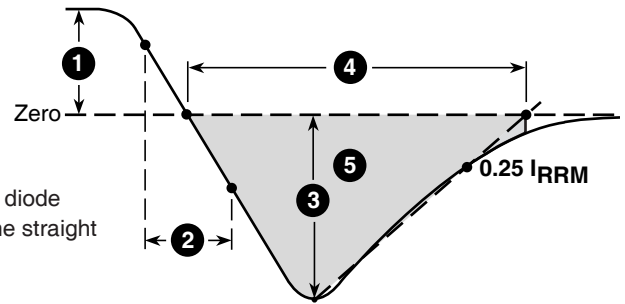
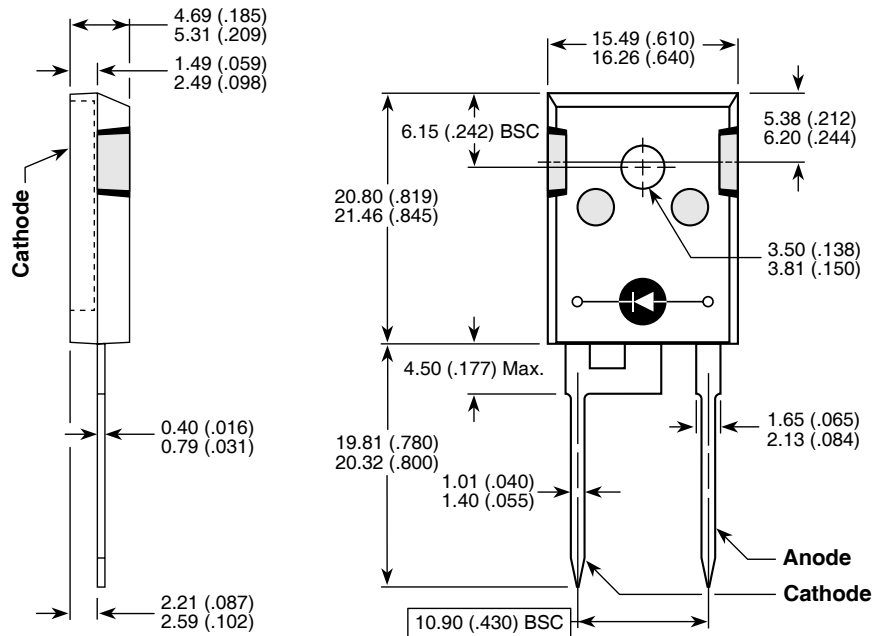

Figure 10, Diode Reverse Recovery Waveform and Definitions

TO-247 Package Outline

e1 SAC: Tin, Silver, Copper



Dimensions in Millimeters and (Inches)



Компания «ЭлектроПласт» предлагает заключение долгосрочных отношений при поставках импортных электронных компонентов на взаимовыгодных условиях!

Наши преимущества:

- Оперативные поставки широкого спектра электронных компонентов отечественного и импортного производства напрямую от производителей и с крупнейших мировых складов;
- Поставка более 17-ти миллионов наименований электронных компонентов;
- Поставка сложных, дефицитных, либо снятых с производства позиций;
- Оперативные сроки поставки под заказ (от 5 рабочих дней);
- Экспресс доставка в любую точку России;
- Техническая поддержка проекта, помощь в подборе аналогов, поставка прототипов;
- Система менеджмента качества сертифицирована по Международному стандарту ISO 9001;
- Лицензия ФСБ на осуществление работ с использованием сведений, составляющих государственную тайну;
- Поставка специализированных компонентов (Xilinx, Altera, Analog Devices, Intersil, Interpoint, Microsemi, Aeroflex, Peregrine, Syfer, Eurofarad, Texas Instrument, Miteq, Cobham, E2V, MA-COM, Hittite, Mini-Circuits, General Dynamics и др.);

Помимо этого, одним из направлений компании «ЭлектроПласт» является направление «Источники питания». Мы предлагаем Вам помощь Конструкторского отдела:

- Подбор оптимального решения, техническое обоснование при выборе компонента;
- Подбор аналогов;
- Консультации по применению компонента;
- Поставка образцов и прототипов;
- Техническая поддержка проекта;
- Защита от снятия компонента с производства.



Как с нами связаться

Телефон: 8 (812) 309 58 32 (многоканальный)

Факс: 8 (812) 320-02-42

Электронная почта: org@eplast1.ru

Адрес: 198099, г. Санкт-Петербург, ул. Калинина, дом 2, корпус 4, литера А.