

## Thyristor/Diode Modules M## 501

### Absolute Maximum Ratings

$V_{RRM}$ $V_{DRM}$ [V]	 MCC	 MCD	 MDC
1200	501-12io2	501-12io2	501-12io2
1400	501-14io2	501-14io2	501-14io2
1600	501-16io2	501-16io2	501-16io2
1800	501-18io2	501-18io2	501-18io2

	VOLTAGE RATINGS	MAXIMUM LIMITS	UNITS
$V_{DRM}$	Repetitive peak off-state voltage <sup>1)</sup>	1200-1800	V
$V_{DSM}$	Non-repetitive peak off-state voltage <sup>1)</sup>	1300-1900	V
$V_{RRM}$	Repetitive peak reverse voltage <sup>1)</sup>	1200-1800	V
$V_{RSM}$	Non-repetitive peak reverse voltage <sup>1)</sup>	1300-1900	V

	OTHER RATINGS	MAXIMUM LIMITS	UNITS
$I_{T(AV)M}$	Maximum average on-state current, $T_C = 85^\circ\text{C}$ <sup>2)</sup>	503	A
$I_{T(AV)M}$	Maximum average on-state current, $T_C = 100^\circ\text{C}$ <sup>2)</sup>	347	A
$I_{T(RMS)M}$	Nominal RMS on-state current, $T_C = 55^\circ\text{C}$ <sup>2)</sup>	1195	A
$I_{T(d.c.)}$	D.C. on-state current, $T_C = 55^\circ\text{C}$	985	A
$I_{TSM}$	Peak non-repetitive surge $t_p = 10$ ms, $V_{RM} = 60\%V_{RRM}$ <sup>3)</sup>	14.5	kA
$I_{TSM2}$	Peak non-repetitive surge $t_p = 10$ ms, $V_{RM} \leq 10\text{V}$ <sup>3)</sup>	16.0	kA
$I^2t$	$I^2t$ capacity for fusing $t_p = 10$ ms, $V_{RM} = 60\%V_{RRM}$ <sup>3)</sup>	$1.05 \times 10^6$	$\text{A}^2\text{s}$
$I^2t$	$I^2t$ capacity for fusing $t_p = 10$ ms, $V_{RM} \leq 10\text{V}$ <sup>3)</sup>	$1.28 \times 10^6$	$\text{A}^2\text{s}$
$(di/dt)_{cr}$	Critical rate of rise of on-state current (repetitive) <sup>4)</sup>	200	$\text{A}/\mu\text{s}$
$(di/dt)_{cr}$	Critical rate of rise of on-state current (non-repetitive) <sup>4)</sup>	400	$\text{A}/\mu\text{s}$
$V_{RGM}$	Peak reverse gate voltage	5	V
$P_{G(AV)}$	Mean forward gate power	4	W
$P_{GM}$	Peak forward gate power	30	W
$V_{ISOL}$	Isolation Voltage <sup>5)</sup>	3000	V
$T_{vj\text{ op}}$	Operating temperature range	-40 to +125	$^\circ\text{C}$
$T_{stg}$	Storage temperature range	-40 to +125	$^\circ\text{C}$

#### Notes:

- De-rating factor of 0.13% per  $^\circ\text{C}$  is applicable for  $T_{vj}$  below  $25^\circ\text{C}$ .
- Single phase; 50 Hz,  $180^\circ$  half-sinewave.
- Half-sinewave,  $125^\circ\text{C}$   $T_{vj}$  initial.
- $V_D = 67\% V_{DRM}$ ,  $I_{FG} = 2$  A,  $t_r \leq 0.5\mu\text{s}$ ,  $T_C = 125^\circ\text{C}$ .
- AC RMS voltage, 50 Hz, 1min test

**Characteristics**

	PARAMETER	MIN.	TYP.	MAX.	TEST CONDITIONS <sup>1)</sup>	UNITS
$V_{TM}$	Maximum peak on-state voltage	-	-	1.50	$I_{TM} = 1700$ A	V
$V_{TM}$	Maximum peak on-state voltage	-	-	1.43	$I_{TM} = 1500$ A	V
$V_{T0}$	Threshold voltage	-	-	0.85		V
$r_T$	Slope resistance	-	-	0.30		m $\Omega$
$(dv/dt)_{cr}$	Critical rate of rise of off-state voltage	1000	-	-	$V_D = 80\% V_{DRM}$ , linear ramp, Gate o/c	V/ $\mu$ s
$I_{DRM}$	Peak off-state current	-	-	70	Rated $V_{DRM}$	mA
$I_{RRM}$	Peak reverse current	-	-	70	Rated $V_{RRM}$	mA
$V_{GT}$	Gate trigger voltage	-	-	2.5	$T_{vj} = 25^\circ\text{C}$ , $V_D = 12$ V, $I_T = 3$ A	V
$I_{GT}$	Gate trigger current	-	-	250		mA
$V_{GD}$	Gate non-trigger voltage	0.25	-	-	$67\% V_{DRM}$	V
$I_L$	Latching current	-	-	1000	$V_D = 12$ V, $T_{vj} = 25^\circ\text{C}$	mA
$I_H$	Holding current	-	-	300	$V_D = 12$ V, $T_{vj} = 25^\circ\text{C}$	mA
$t_{gd}$	Gate controlled turn-on delay time	-	-	2.0	$I_{FG} = 2$ A, $t_r = 1$ $\mu$ s, $V_D = 40\% V_{DRM}$ , $I_{TM} = 1500$ A, $di/dt = 10$ A/ $\mu$ s, $T_{vj} = 25^\circ\text{C}$	$\mu$ s
$t_{gt}$	Turn-on time	-	-	8.0		$\mu$ s
$Q_{rr}$	Recovered Charge	-	1350	1550	$I_{TM} = 1000$ A, $t_p = 1$ ms, $di/dt = 10$ A/ $\mu$ s, $V_R = 100$ V	$\mu$ C
$Q_{ra}$	Recovered Charge, 50% chord	-	1150	-		$\mu$ C
$I_{rm}$	Reverse recovery current	-	120	-		A
$t_{rr}$	Reverse recovery time, 50% chord	-	19	-		$\mu$ s
$t_q$	Turn-off time	-	-	200	$I_{TM} = 1500$ A, $t_p = 1$ ms, $di/dt = 10$ A/ $\mu$ s, $V_R = 100$ V, $V_{DR} = 67\% V_{DRM}$ , $dv_{DR}/dt = 50$ V/ $\mu$ s	$\mu$ s
$R_{thJC}$	Thermal resistance, junction to case	-	-	0.062	Single Thyristor	K/W
		-	-	0.031	Whole Module	K/W
$R_{thCH}$	Thermal resistance, case to heatsink	-	-	0.02	Single Thyristor	K/W
		-	-	0.01	Whole Module	K/W
$F_1$	Mounting force (to heatsink)	4.25	-	5.75	<sup>2)</sup>	Nm
$F_2$	Mounting force (to terminals)	10.2	-	13.8		Nm
$W_t$	Weight	-	1.5	-		kg

**Notes:**

- 1) Unless otherwise indicated  $T_{vj} = 125^\circ\text{C}$ .
- 2) Screws must be lubricated.

## Notes on Ratings and Characteristics

### 1.0 Voltage Grade Table

Voltage Grade	$V_{DRM}$ $V_{RRM}$ V	$V_{DSM}$ $V_{RSM}$ V	$V_D$ $V_R$ DC V
12	1200	1300	900
14	1400	1500	1050
16	1600	1700	1200
18	1800	1900	1350

### 2.0 Extension of Voltage Grades

This report is applicable to other voltage grades when supply has been agreed by Sales/Production.

### 3.0 De-rating Factor

A blocking voltage de-rating factor of 0.13%/°C is applicable to this device for  $T_{vj}$  below 25°C.

### 4.0 Repetitive dv/dt

Standard dv/dt is 1000V/μs.

### 5.0 Snubber Components

When selecting snubber components, care must be taken not to use excessively large values of snubber capacitor or excessively small values of snubber resistor. Such excessive component values may lead to device damage due to the large resultant values of snubber discharge current. If required, please consult the factory for assistance.

### 6.0 Rate of rise of on-state current

The maximum un-primed rate of rise of on-state current must not exceed 400A/μs at any time during turn-on on a non-repetitive basis. For repetitive performance, the on-state rate of rise of current must not exceed 200A/μs at any time during turn-on. Note that these values of rate of rise of current apply to the total device current including that from any local snubber network.

### 7.0 Gate Drive

The nominal requirement for a typical gate drive is illustrated below. An open circuit voltage of at least 30V is assumed. This gate drive must be applied when using the full di/dt capability of the device.

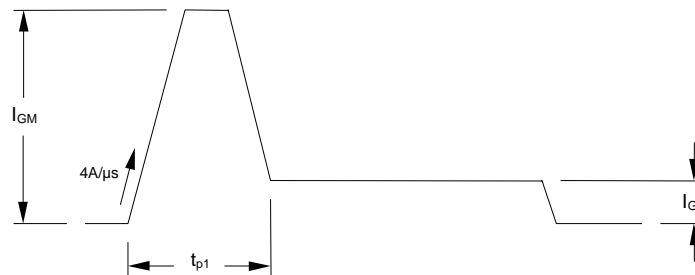

The magnitude of  $I_{GM}$  should be between five and ten times  $I_{GT}$ , which is shown on page 2. Its duration ( $t_{p1}$ ) should be 20μs or sufficient to allow the anode current to reach ten times  $I_L$ , whichever is greater. Otherwise, an increase in pulse current would be needed to supply the necessary charge to trigger. The 'back-porch' current  $I_G$  should remain flowing for the same duration as the anode current and have a magnitude in the order of 1.5 times  $I_{GT}$ .

## 8.0 Computer Modelling Parameters

### 8.1 Thyristor Dissipation Calculations

$$I_{AV} = \frac{-V_{T0} + \sqrt{V_{T0}^2 + 4 \cdot ff^2 \cdot r_T \cdot W_{AV}}}{2 \cdot ff^2 \cdot r_T} \quad \text{and:} \quad W_{AV} = \frac{\Delta T}{R_{th}}$$

$$\Delta T = T_{j \max} - T_K$$

Where  $V_{T0} = 0.85 \text{ V}$ ,  $r_T = 0.30 \text{ m}\Omega$ .

$R_{th}$  = Supplementary thermal impedance, see table below and

$ff$  = Form factor, see table below.

Supplementary Thermal Impedance							
Conduction Angle	30°	60°	90°	120°	180°	270°	d.c.
Square wave	0.0702	0.0685	0.0679	0.0668	0.0658	0.0637	0.0620
Sine wave	0.0677	0.0673	0.0664	0.0655	0.0650		

Form Factors							
Conduction Angle	30°	60°	90°	120°	180°	270°	d.c.
Square wave	3.464	2.449	2	1.732	1.414	1.149	1
Sine wave	3.98	2.778	2.22	1.879	1.57		

### 8.2 Calculating thyristor $V_T$ using ABCD Coefficients

The on-state characteristic  $I_T$  vs.  $V_T$ , on page 6 is represented by a set of constants A, B, C, D, forming the coefficients of the representative equation for  $V_T$  in terms of  $I_T$  given below:

$$V_T = A + B \cdot \ln(I_T) + C \cdot I_T + D \cdot \sqrt{I_T}$$

The constants, derived by curve fitting software, are given below for both hot and cold characteristics. The resulting values for  $V_T$  agree with the true device characteristic over a current range, which is limited to that plotted.

25°C Coefficients		125°C Coefficients	
A	1.27624207	A	1.1481301
B	$5.582967 \times 10^{-4}$	B	-0.07739233
C	$2.407706 \times 10^{-4}$	C	$1.873999 \times 10^{-4}$
D	$-4.020685 \times 10^{-3}$	D	0.01475625

## 8.3 D.C. Thermal Impedance Calculation

$$r_t = \sum_{p=1}^{p=n} r_p \cdot \left( 1 - e^{-\frac{t}{\tau_p}} \right)$$

Where  $p = 1$  to  $n$  and:

- $n$  = number of terms in the series
- $t$  = Duration of heating pulse in seconds
- $r_t$  = Thermal resistance at time  $t$
- $r_p$  = Amplitude of  $p_{th}$  term
- $\tau_p$  = Time Constant of  $r_{th}$  term

The coefficients for this device are shown in the table below:

D.C.					
Term	1	2	3	4	5
$r_p$	$1.37 \times 10^{-3}$	$4.86 \times 10^{-3}$	0.0114	0.0223	0.0221
$\tau_p$	$7.6 \times 10^{-4}$	$8.6 \times 10^{-3}$	0.101	0.56	3.12

## 9.0 Reverse recovery ratings

(i)  $Q_{ra}$  is based on 50%  $I_{RM}$  chord as shown in Fig. 1

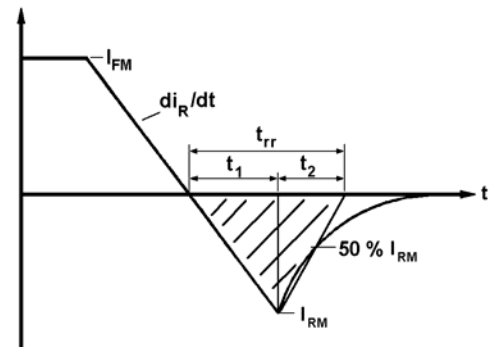

Fig. 1

(ii)  $Q_{rr}$  is based on a  $150 \mu s$  integration time i.e.

$$Q_{rr} = \int_0^{150 \mu s} i_{rr} \cdot dt$$

(iii)

$$K \text{ Factor} = \frac{t_1}{t_2}$$

**Curves**

Figure 1 – On-state characteristics of Limit device

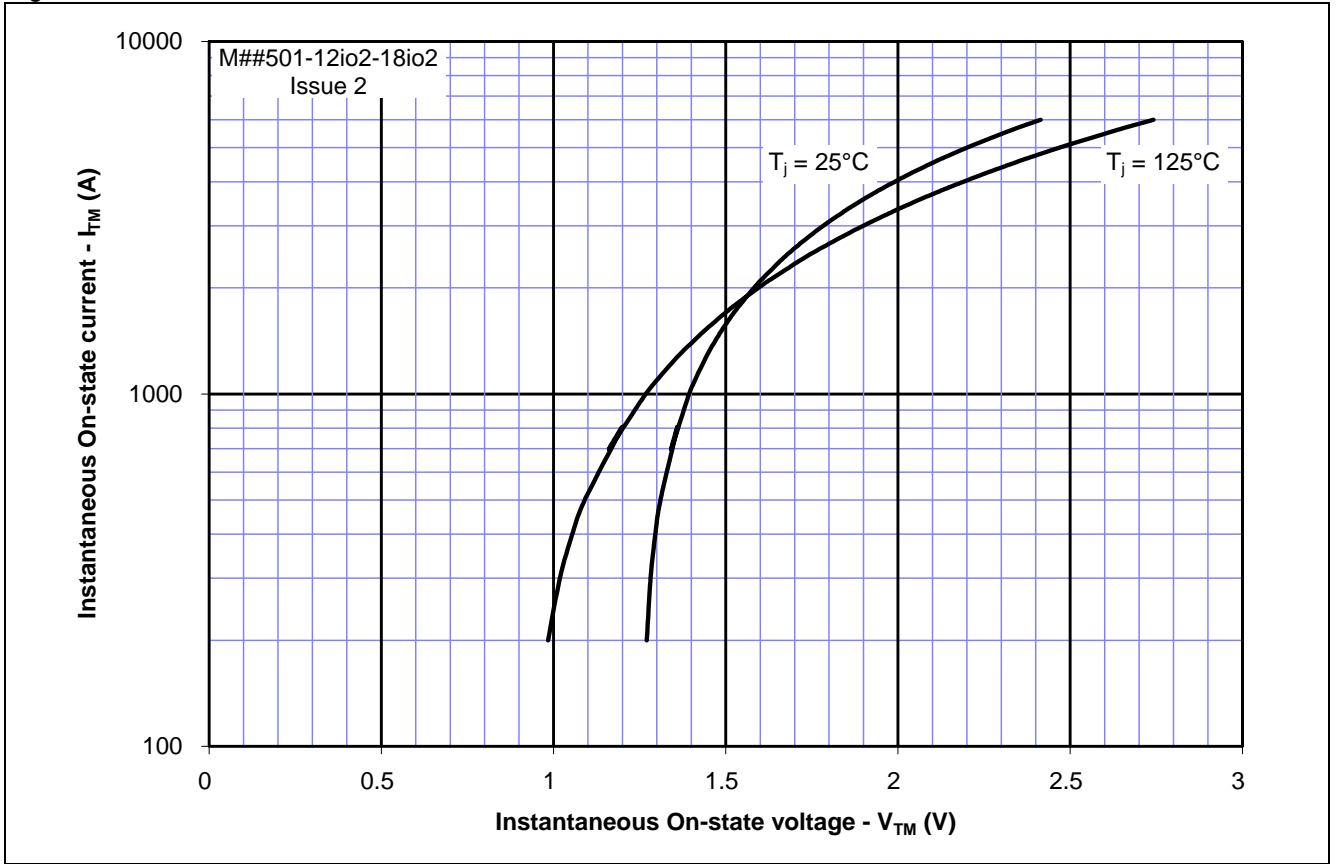

Figure 2 – Gate characteristics – Trigger limits

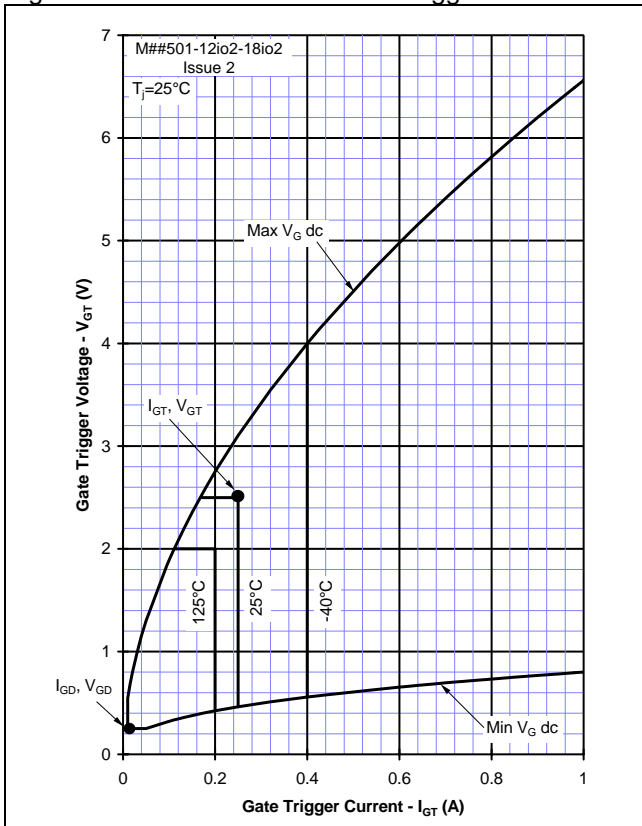

Figure 3 – Gate characteristics – Power curves

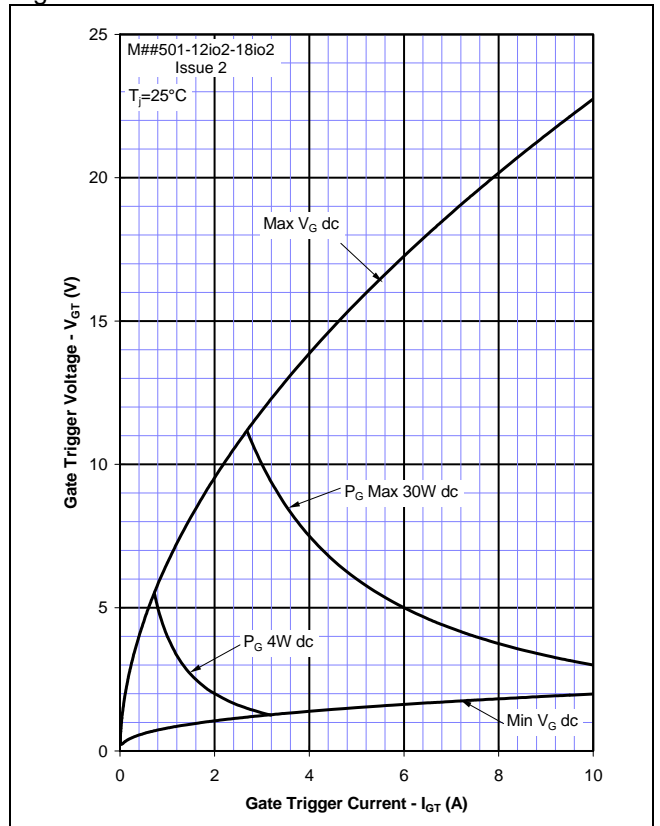

Figure 4 - Total recovered charge,  $Q_{rr}$

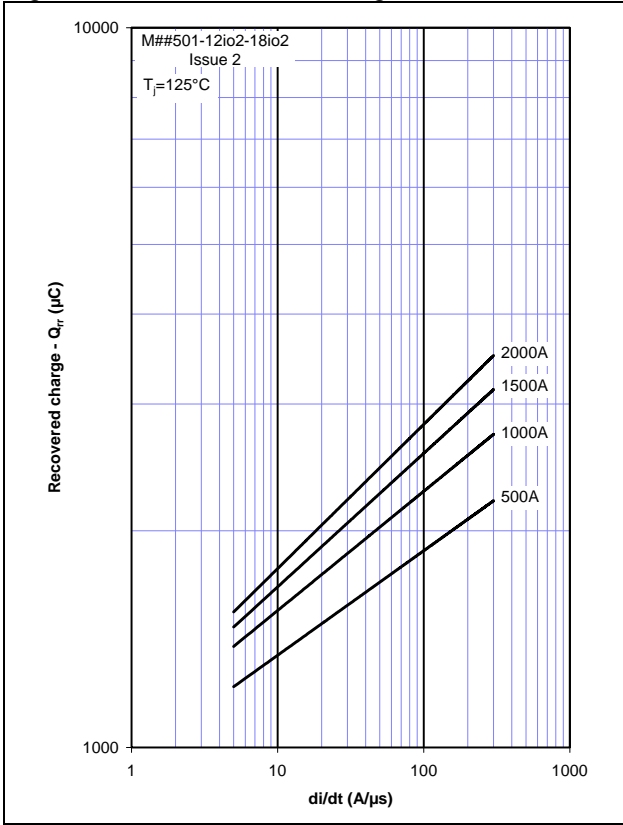

Figure 5 - Recovered charge,  $Q_{ra}$  (50% chord)

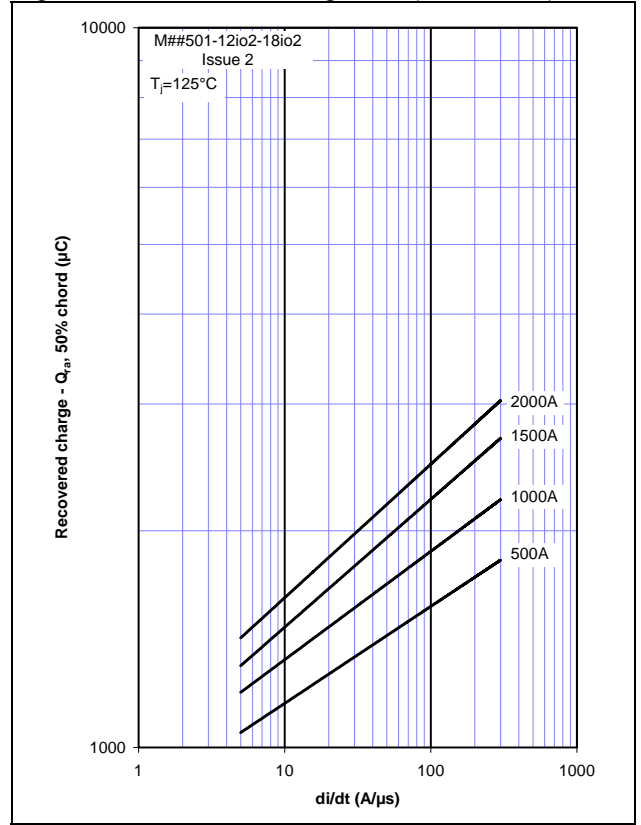

Figure 6 - Peak reverse recovery current,  $I_{rm}$

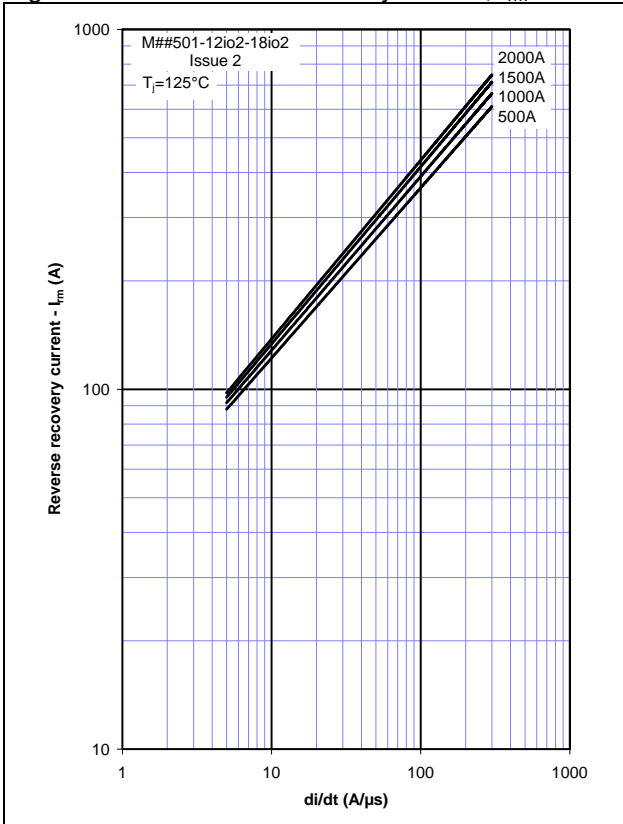

Figure 7 - Maximum recovery time,  $t_{rr}$  (50% chord)

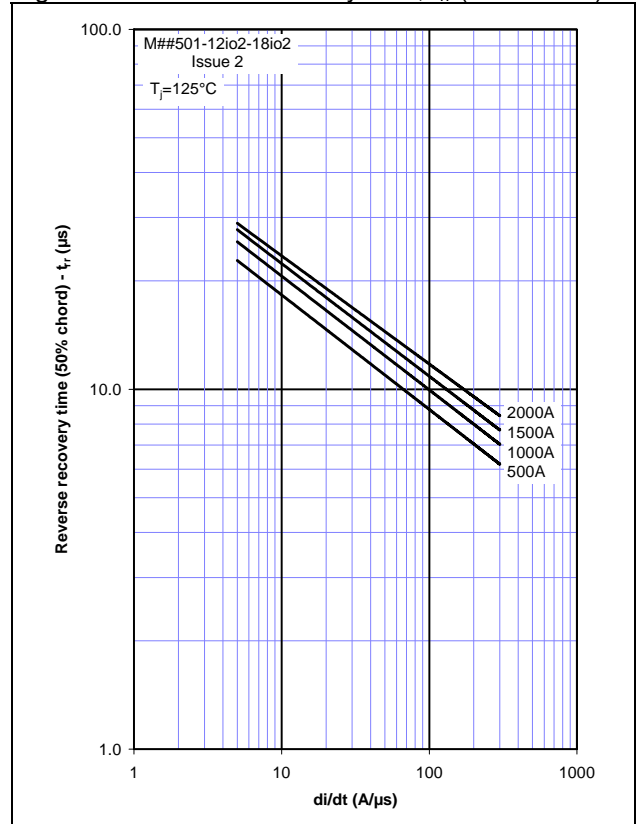

Figure 8 – On-state current vs. Power dissipation – Sine wave

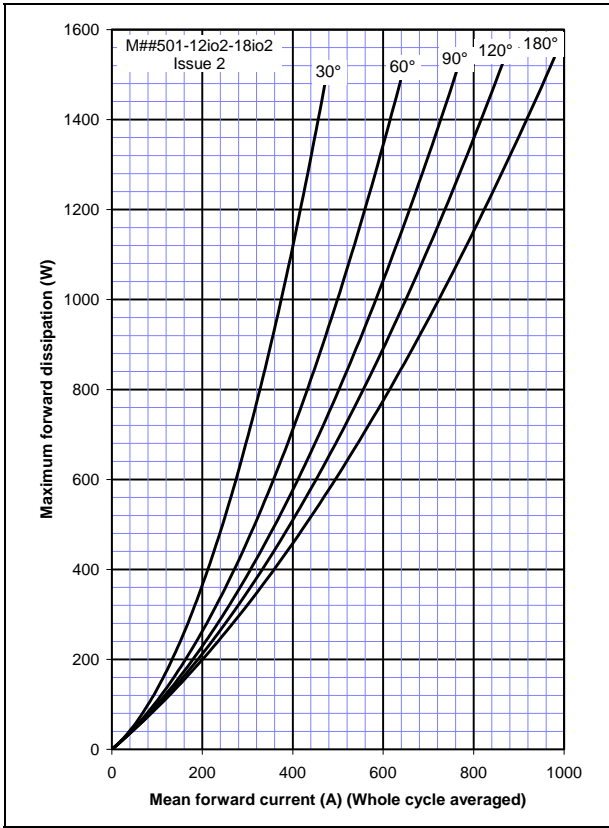

Figure 9 – On-state current vs. Heatsink temperature – Sine wave

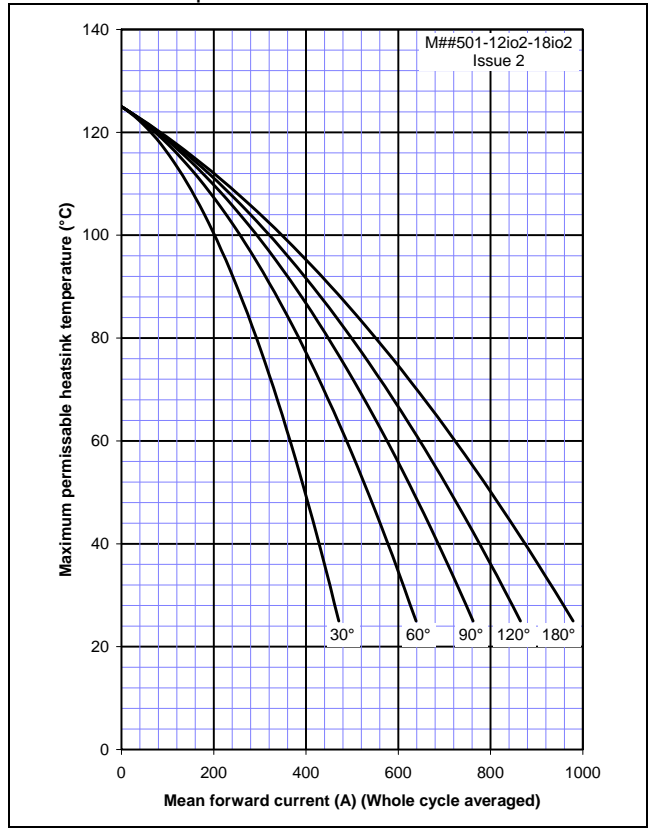

Figure 10 – On-state current vs. Power dissipation – Square wave

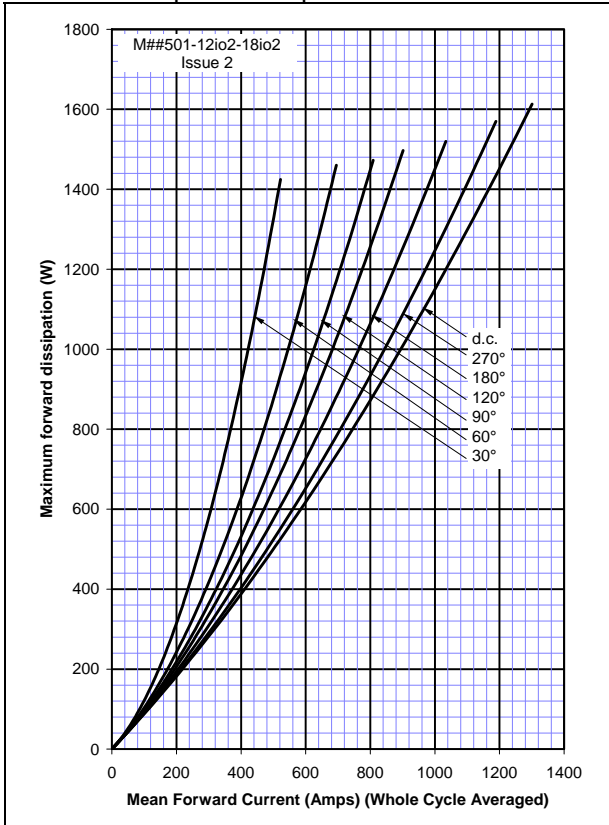

Figure 11 – On-state current vs. Heatsink temperature – Square wave

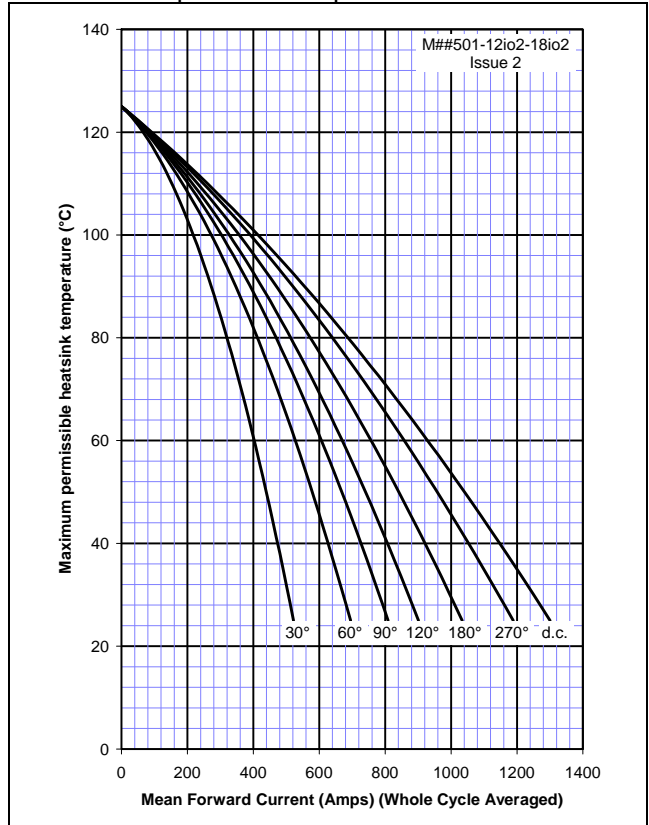



Figure 12 – Maximum surge and  $I^2t$  Ratings

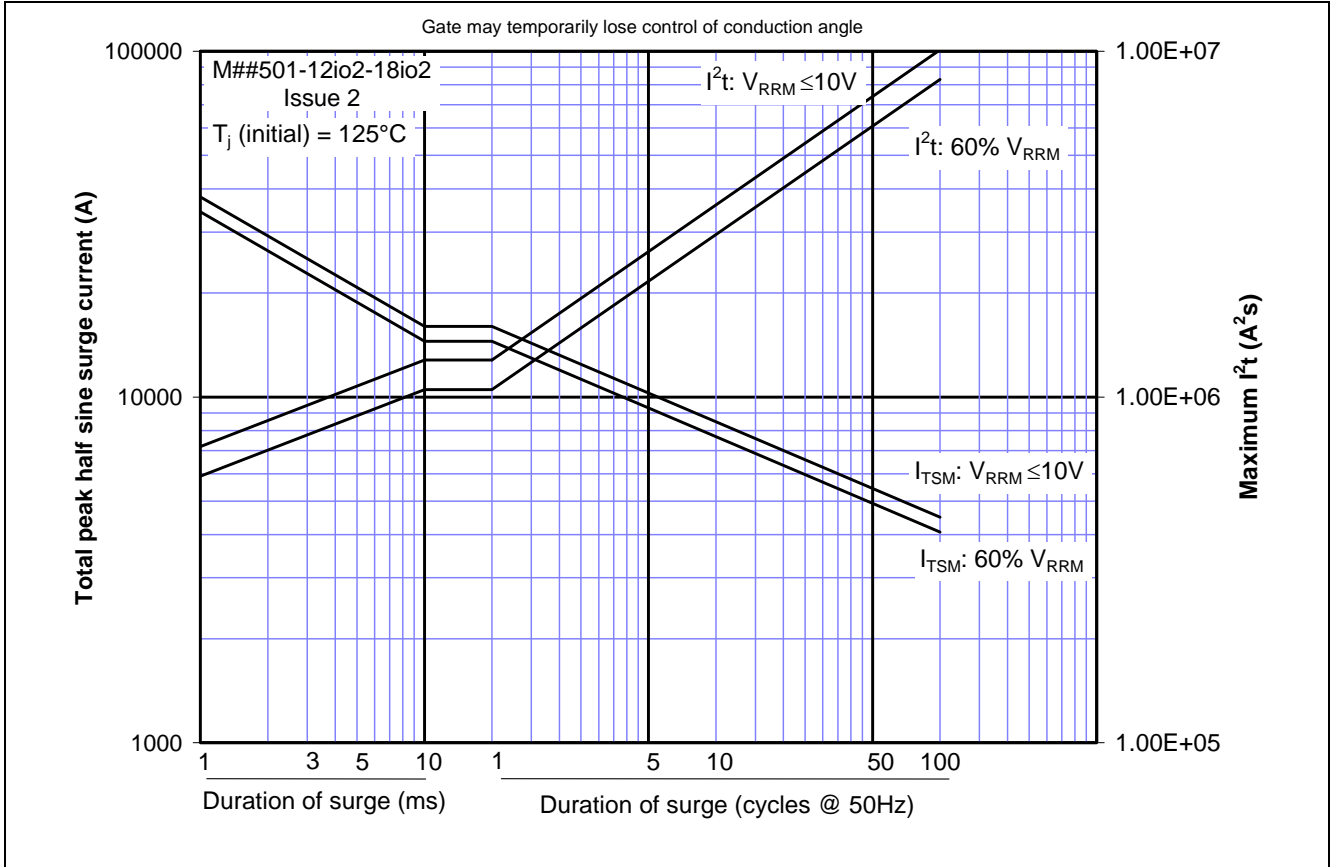
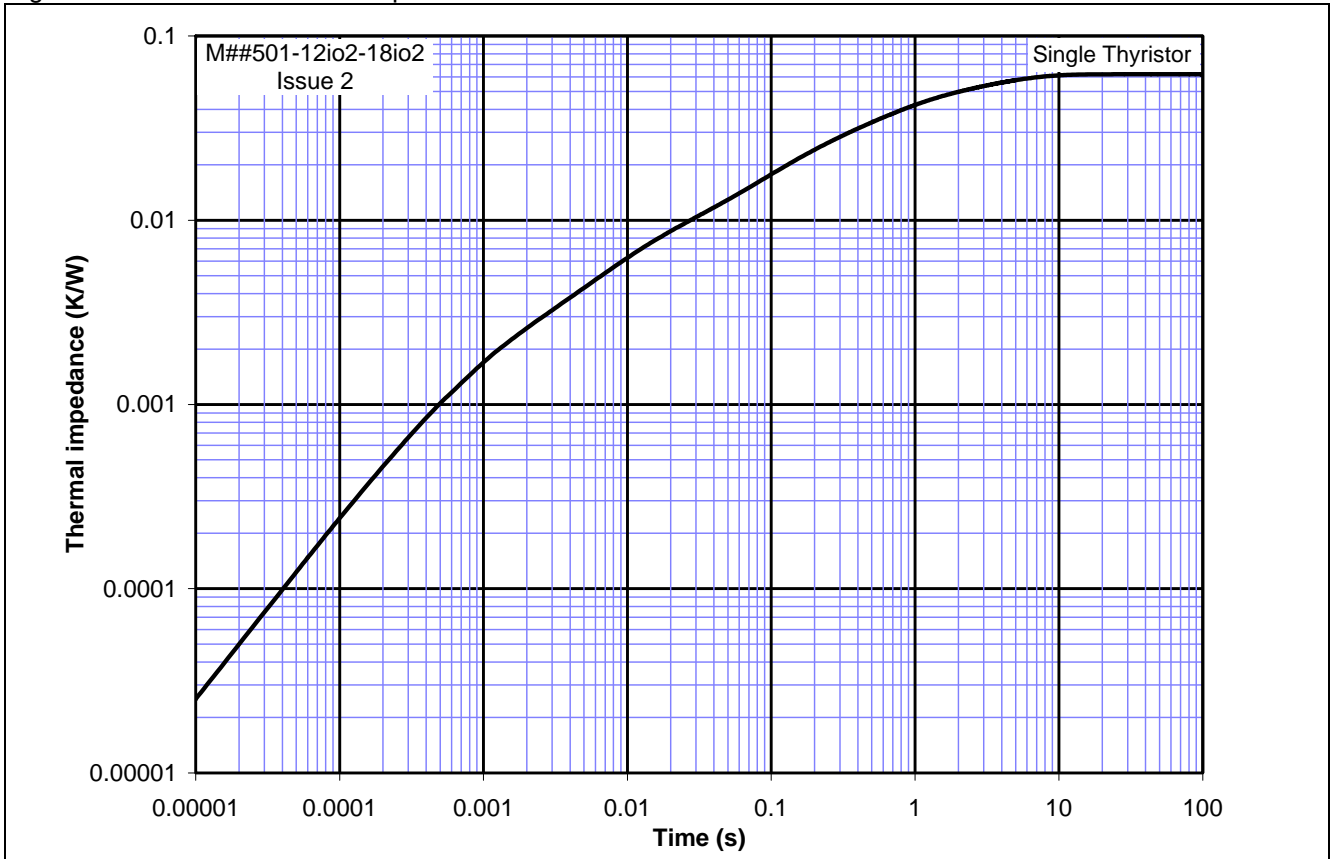
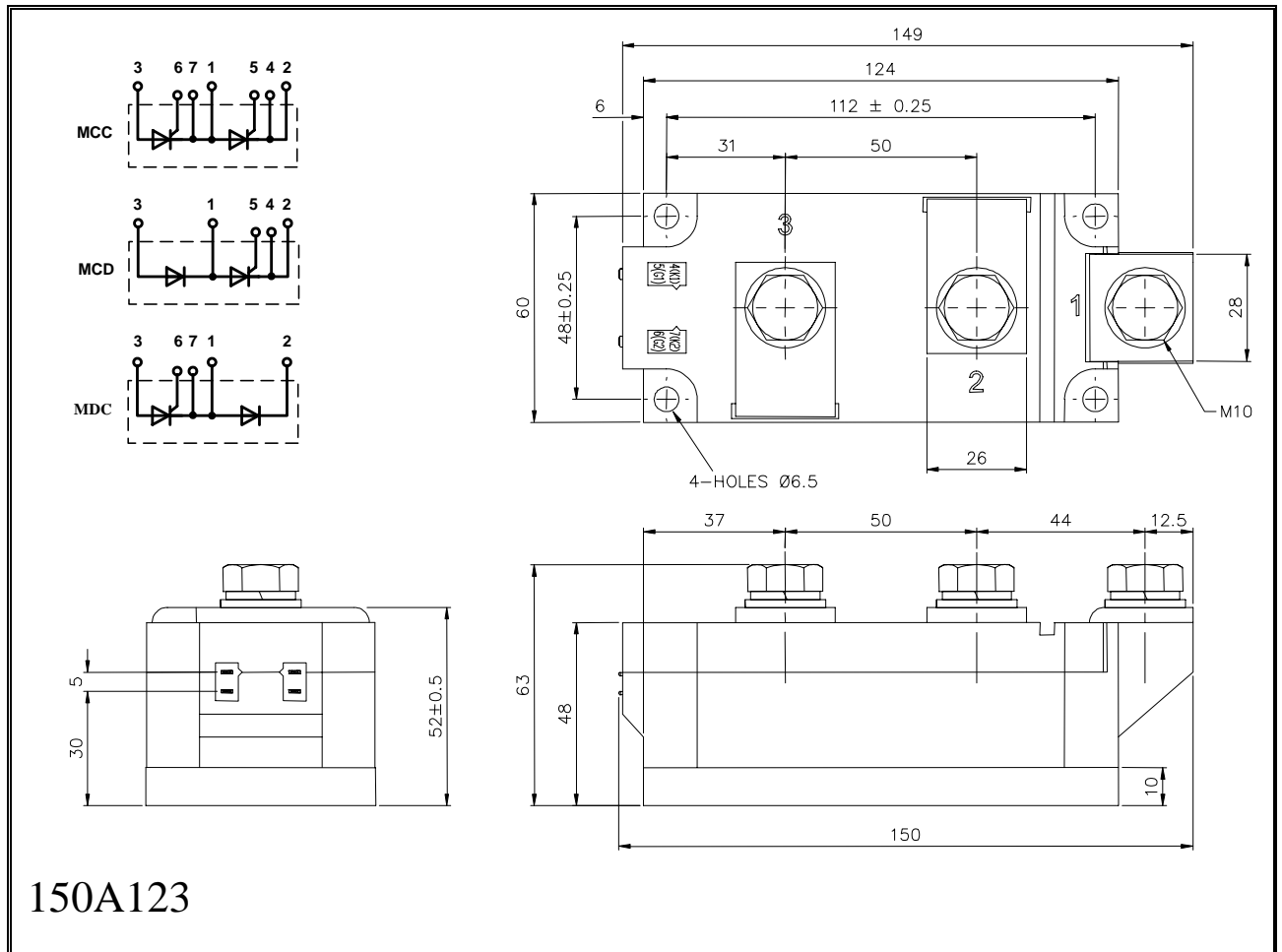

Figure 13 – Transient thermal impedance



Outline Drawing & Ordering Information



150A123

ORDERING INFORMATION

(Please quote 11 digit code as below)

<b>M</b>	<b>##</b>	<b>501</b>	<b>◆◆</b>	<b>io</b>	<b>2</b>
Fixed Type Code	Configuration code CC, CD or DC	Fixed Type Code	Voltage code $V_{RRM}/100$ 12-18	i = Critical dv/dt 1000 V/μs o = Typical turn-off time	Fixed Version Code

Typical order code: MCD501-14io2– MCD configuration, 1400V  $V_{RRM}$

**IXYS Semiconductor GmbH**  
Edisonstraße 15  
D-68623 Lampertheim  
Tel: +49 6206 503-0  
Fax: +49 6206 503-627  
E-mail: [marcom@ixys.de](mailto:marcom@ixys.de)



[www.ixys.com](http://www.ixys.com)

**IXYS Corporation**  
1590 Buckeye Drive  
Milpitas CA 95035 7418 USA  
Tel: +1 (408) 547 9000  
Fax: +1 (408) 496 0670  
E-mail: [sales@ixys.net](mailto:sales@ixys.net)

**WESTCODE**

An IXYS Company

[www.westcode.com](http://www.westcode.com)

**Westcode Semiconductors Ltd**  
Langley Park Way, Langley Park,  
Chippenham, Wiltshire, SN15 1GE.  
Tel: +44 (0)1249 444524  
Fax: +44 (0)1249 659448  
E-mail: [WSL.sales@westcode.com](mailto:WSL.sales@westcode.com)

**IXYS Long Beach, Inc**  
2500 Mira Mar Ave, Long Beach  
CA 90815  
Tel: +1 (562) 296 6584  
Fax: +1 (562) 296 6585  
E-mail: [service@ixyslongbeach.com](mailto:service@ixyslongbeach.com)

The information contained herein is confidential and is protected by Copyright. The information may not be used or disclosed except with the written permission of and in the manner permitted by the proprietors IXYS Semiconductors GmbH.  
In the interest of product improvement, IXYS reserves the right to change specifications at any time without prior notice.

© IXYS Semiconductor GmbH.



Компания «ЭлектроПласт» предлагает заключение долгосрочных отношений при поставках импортных электронных компонентов на взаимовыгодных условиях!

Наши преимущества:

- Оперативные поставки широкого спектра электронных компонентов отечественного и импортного производства напрямую от производителей и с крупнейших мировых складов;
- Поставка более 17-ти миллионов наименований электронных компонентов;
- Поставка сложных, дефицитных, либо снятых с производства позиций;
- Оперативные сроки поставки под заказ (от 5 рабочих дней);
- Экспресс доставка в любую точку России;
- Техническая поддержка проекта, помощь в подборе аналогов, поставка прототипов;
- Система менеджмента качества сертифицирована по Международному стандарту ISO 9001;
- Лицензия ФСБ на осуществление работ с использованием сведений, составляющих государственную тайну;
- Поставка специализированных компонентов (Xilinx, Altera, Analog Devices, Intersil, Interpoint, Microsemi, Aeroflex, Peregrine, Syfer, Eurofarad, Texas Instrument, Miteq, Cobham, E2V, MA-COM, Hittite, Mini-Circuits, General Dynamics и др.);

Помимо этого, одним из направлений компании «ЭлектроПласт» является направление «Источники питания». Мы предлагаем Вам помощь Конструкторского отдела:

- Подбор оптимального решения, техническое обоснование при выборе компонента;
- Подбор аналогов;
- Консультации по применению компонента;
- Поставка образцов и прототипов;
- Техническая поддержка проекта;
- Защита от снятия компонента с производства.



#### Как с нами связаться

**Телефон:** 8 (812) 309 58 32 (многоканальный)

**Факс:** 8 (812) 320-02-42

**Электронная почта:** [org@eplast1.ru](mailto:org@eplast1.ru)

**Адрес:** 198099, г. Санкт-Петербург, ул. Калинина, дом 2, корпус 4, литера А.