

ISL1557

xDSL Differential Line Driver

FN7522  
Rev.5.00  
Nov 7, 2019

The [ISL1557](#) is a dual operational amplifier designed for VDSL2 and ADSL line driving in DMT based solutions. This device features a high drive capability of 750mA while consuming only 6mA of supply current per amplifier and operating from a single 4.5V to 12V supply. The driver achieves a typical distortion of -80dBc at 150kHz into a 25Ω load.

The ISL1557 is available in the thermally-enhanced 16 Ld QFN and 10 Ld HMSOP package and is specified for operation across -40°C to +85°C (IRZ, IUEZ) or -40°C to +125°C (FRZ) temperature ranges. The ISL1557 has control pins C0 and C1 for controlling the bias and enable/disable of the outputs. These controls allow for lowering the power to fit the performance/power ratio for the application.

The ISL1557 is ideal for ADSL2+, SDSL, HDSL2, and VDSL line driving applications, including both 14.5dBm and 21dBm applications.

**Related Literature**

For a full list of related documents, visit our website

- [ISL1557](#) product page

**Features**

- Full-range industrial temperature (FRZ only): -40°C to +125°C
- 21dBm output power capability
- Drives up to 750mA from a +12V supply
- 20V<sub>P-P</sub> differential output drive into 21Ω
- -80dBc typical driver output distortion at full output at 150kHz
- -75dBc typical driver output distortion at 4MHz
- -71dBc typical driver output distortion at 10MHz
- -75dBc typical driver output distortion at 17MHz
- Low quiescent current of 6mA per amplifier
- Supply range
  - ISL1557IRZ, ISL1557FRZ . . . ±2.25V to ±6V, 4.5V to 12V
  - ISL1557IUEZ . . . . . 4.5V to 12V
- 300MHz bandwidth
- Thermal shutdown
- Pb-free (RoHS compliant)

**Applications**

- VDSL2 line drivers
- Power line communications line drivers
- ADSL2+ CPE line driving
- G.SHDSL and HDSL2 line drivers

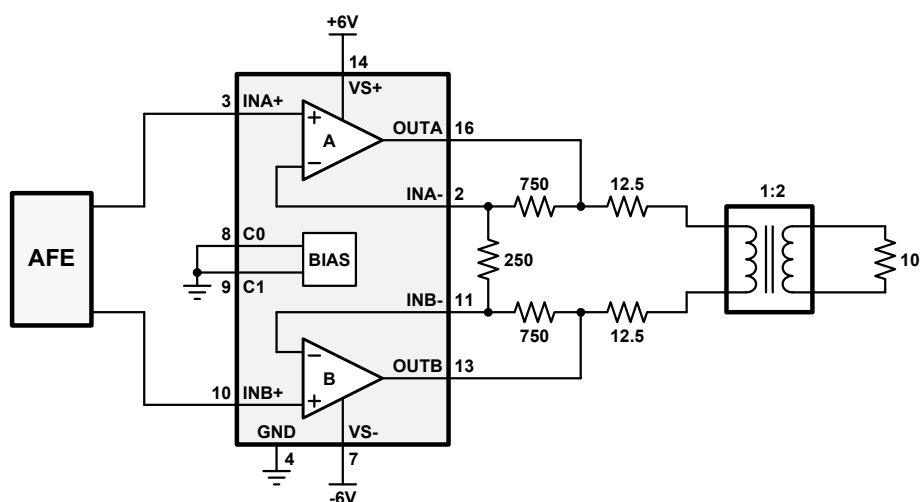

FIGURE 1. TYPICAL OPERATING CIRCUIT

## Ordering Information

| PART NUMBER<br>(Notes 2, 3) | PART MARKING     | TEMP. RANGE (°C) | TAPE AND REEL (UNITS) (Note 1) | PACKAGE (RoHS COMPLIANT) | PKG. DWG. # |
|-----------------------------|------------------|------------------|--------------------------------|--------------------------|-------------|
| ISL1557FRZ                  | 155 7FRZ         | -40 to +125      | -                              | 16 Ld 4x4 QFN            | L16.4x4H    |
| ISL1557FRZ-T7               | 155 7FRZ         | -40 to +125      | 1k                             | 16 Ld 4x4 QFN            | L16.4x4H    |
| ISL1557IRZ                  | 155 7IRZ         | -40 to +85       | -                              | 16 Ld 4x4 QFN            | L16.4x4H    |
| ISL1557IRZ-T7               | 155 7IRZ         | -40 to +85       | 1k                             | 16 Ld 4x4 QFN            | L16.4x4H    |
| ISL1557IUEZ                 | BBVAA            | -40 to +85       | -                              | 10 Ld HMSOP              | M10.118B    |
| ISL1557IUEZ-T7              | BBVAA            | -40 to +85       | 1.5k                           | 10 Ld HMSOP              | M10.118B    |
| ISL1557IRZ-EVAL             | Evaluation Board |                  |                                |                          |             |

### NOTES:

1. Refer to [TB347](#) for details about reel specifications.
2. These Pb-free plastic packaged products employ special Pb-free material sets; molding compounds/die attach materials and 100% matte tin plate PLUS ANNEAL - e3 termination finish, which is RoHS compliant and compatible with both SnPb and Pb-free soldering operations. Pb-free products are MSL classified at Pb-free peak reflow temperatures that meet or exceed the Pb-free requirements of IPC/JEDEC J STD-020.
3. For Moisture Sensitivity Level (MSL), refer to the [ISL1557](#) product information page. For more information about MSL, refer to [TB363](#).

## Pin Configurations

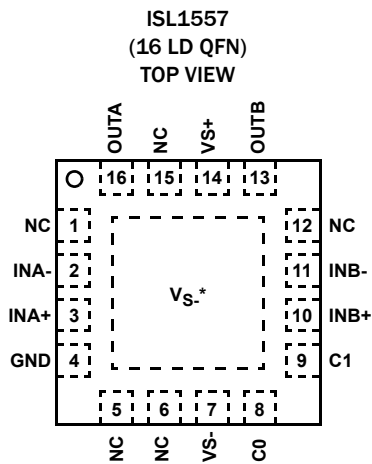

\*THERMAL PAD MUST BE CONNECTED TO NEGATIVE SUPPLY:  $V_{S-}$ .  
QFN PACKAGE CAN BE USED IN SINGLE AND DUAL SUPPLY APPLICATIONS.

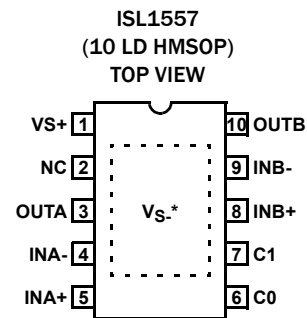

\*THERMAL PAD MUST BE CONNECTED TO NEGATIVE SUPPLY:  $V_{S-}$ .  
HMSOP PACKAGE CAN BE USED IN SINGLE SUPPLY APPLICATIONS ONLY.

## Pin Descriptions

| 16 LD QFN<br>(Note 4) | 10 LD HMSOP<br>(Note 5) | PIN NAME | FUNCTION                           |
|-----------------------|-------------------------|----------|------------------------------------|
| 1, 5, 6, 12, 15       | 2                       | NC       | No Connect                         |
| 2                     | 4                       | INA-     | Inverting Input of Amplifier A     |
| 3                     | 5                       | INA+     | Non-Inverting Input of Amplifier A |
| 4                     | -                       | GND      | Ground Connect                     |
| 7                     | -                       | VS-      | Negative Supply                    |
| 8                     | 6                       | CO       | Bias Control Pin 0                 |
| 9                     | 7                       | C1       | Bias Control Pin 1                 |
| 10                    | 8                       | INB+     | Non-Inverting Input of Amplifier B |
| 11                    | 9                       | INB-     | Inverting Input of Amplifier B     |
| 13                    | 10                      | OUTB     | Output of Amplifier B              |
| 14                    | 1                       | VS+      | Positive Supply                    |
| 16                    | 3                       | OUTA     | Output of Amplifier A              |

## NOTE:

4. Thermal pad must be connected to negative supply:  $V_{S-}$ . QFN package can be used in single and dual supply applications.
5. Thermal pad must be connected to negative supply:  $V_{S-}$ . HMSOP package can be used in single supply applications only.

TABLE 1. BIAS MODE CONTROL

| CONTROL INPUTS |        | BIAS MODES | TYPICAL SUPPLY CURRENT PER AMPLIFIER (mA) |
|----------------|--------|------------|---|
| CO (V)         | C1 (V) |            |   |
| 0              | 0      | Full       | 15  |
| 0              | 5      | Medium     | 11  |
| 5              | 0      | Low        | 6.0                                       |
| 5              | 5      | Power Down | 0.6                                       |

**Absolute Maximum Ratings** ( $T_A = +25^\circ\text{C}$ )

|                            |                 |
|----------------------------|-----------------|
| $V_{S+}$ Voltage to Ground | -0.3V to +13.2V |
| $V_{IN+}$ Voltage          | GND to $V_{S+}$ |
| Current into any Input     | 8mA             |
| Continuous Output Current  | 75mA            |
| $C_0, C_1$ to Ground       | +6.6V           |
| ESD Rating                 |                 |
| Human Body Model           | 3kV             |
| Machine Model              | 250V            |

**Thermal Information**

|                                     |   |   |
|-------------------------------------|---|---|
| Thermal Resistance                  | $\theta_{JA}$ ( $^\circ\text{C}/\text{W}$ )   | $\theta_{JC}$ ( $^\circ\text{C}/\text{W}$ ) |
| 10 Ld HMSOP Package (Notes 6, 7)    | 62  | 14  |
| 16 Ld QFN Package (Notes 6, 7)      | 52  | 14  |
| Ambient Operating Temperature Range |   |   |
| ISL1557FRZ                          | -40 $^\circ\text{C}$ to +125 $^\circ\text{C}$ |   |
| ISL1557IRZ, ISL1557IUEZ             | -40 $^\circ\text{C}$ to +85 $^\circ\text{C}$  |   |
| Storage Temperature Range           | -60 $^\circ\text{C}$ to +150 $^\circ\text{C}$ |   |
| Operating Junction Temperature      | +150 $^\circ\text{C}$                         |   |
| Power Dissipation                   | See Figure 24 on page 9                       |   |
| Pb-Free reflow profile              | see TB493                                     |   |

**CAUTION:** Do not operate at or near the maximum ratings listed for extended periods of time. Exposure to such conditions may adversely impact product reliability and result in failures not covered by warranty.

**NOTES:**

- $\theta_{JA}$  is measured in free air with the component mounted on a high-effective thermal conductivity test board with "direct attach" features. See TB379.
- For  $\theta_{JC}$ , the "case temp" location is the center of the exposed metal pad on the package underside.

**Electrical Specifications**  $V_S = 12\text{V}$ ,  $R_F = 750\Omega$ ,  $R_{L-DIFF} = 50\Omega$ ,  $T_A = +25^\circ\text{C}$ , unless otherwise specified.

| PARAMETER                                      | SYMBOL       | CONDITIONS   | MIN<br>(Note 8) | TYP       | MAX<br>(Note 8) | UNIT                         |
|--|--------------|--|-----------------|-----------|-----------------|------------------------------|
| <b>AC PERFORMANCE</b>                          |              |  |                 |           |                 |                              |
| -3dB Bandwidth                                 | BW           | $R_F = 499\Omega$ , $A_V = +5$                                     |                 | 300       |                 | MHz                          |
|  |              | $R_F = 750\Omega$ , $A_V = +5$                                     |                 | 250       |                 | MHz                          |
|  |              | $R_F = 750\Omega$ , $A_V = +10$                                    |                 | 200       |                 | MHz                          |
| Total Harmonic Distortion, Differential        | THD          | $f = 200\text{kHz}$ , $V_O = 16V_{P-P}$ , $R_{L-DIFF} = 100\Omega$ | -72             | -83       |                 | dBc                          |
|  |              | $f = 4\text{MHz}$ , $V_O = 2V_{P-P}$ , $R_{L-DIFF} = 100\Omega$    |                 | -75       |                 | dBc                          |
|  |              | $f = 10\text{MHz}$ , $V_O = 2V_{P-P}$ , $R_{L-DIFF} = 100\Omega$   |                 | -71       |                 | dBc                          |
|  |              | $f = 17\text{MHz}$ , $V_O = 2V_{P-P}$ , $R_{L-DIFF} = 100\Omega$   |                 | -75       |                 | dBc                          |
| Slew Rate, Single-Ended                        | SR           | $V_{OUT}$ from -3V to +3V  | 750             | 1200      |                 | V/ $\mu\text{s}$             |
| <b>DC PERFORMANCE</b>                          |              |  |                 |           |                 |                              |
| Offset Voltage Common-Mode                     | $V_{OS\_CM}$ |  | -40             |           | +40             | mV                           |
| Offset Voltage Differential Mode               | $V_{OS\_DM}$ |  | -7.5            |           | +7.5            | mV                           |
| Differential Transimpedance                    | $R_{OL}$     | $V_{OUT} = 12V_{P-P}$ differential, unloaded                       |                 | 3.0       |                 | M $\Omega$                   |
| <b>INPUT CHARACTERISTICS</b>                   |              |  |                 |           |                 |                              |
| Non-Inverting Input Bias Current               | $I_{B+}$     |  | -7.0            |           | +7.0            | $\mu\text{A}$                |
| Inverting Input Bias Current Differential Mode | $I_{B-DM}$   |  | -75             | 3         | +75             | $\mu\text{A}$                |
| Input Noise Voltage                            | $e_N$        |  |                 | 6         |                 | $\text{nV}/\sqrt{\text{Hz}}$ |
| -Input Noise Current                           | $i_N$        |  |                 | 13        |                 | $\text{pA}/\sqrt{\text{Hz}}$ |
| <b>OUTPUT CHARACTERISTICS</b>                  |              |  |                 |           |                 |                              |
| Loaded Output Swing (Single-Ended)             | $V_{OUT}$    | $V_S = \pm 6\text{V}$ , $R_{L-DIFF} = 50\Omega$ (FRZ)              | $\pm 4.75$      | $\pm 5.0$ |                 | V                            |
|  |              | $V_S = \pm 6\text{V}$ , $R_{L-DIFF} = 20\Omega$ (FRZ)              | $\pm 4.20$      | $\pm 4.7$ |                 | V                            |
|  |              | $V_S = \pm 6\text{V}$ , $R_{L-DIFF} = 50\Omega$ (IRZ, IUEZ)        | $\pm 4.85$      | $\pm 5.0$ |                 | V                            |
|  |              | $V_S = \pm 6\text{V}$ , $R_{L-DIFF} = 20\Omega$ (IRZ, IUEZ)        | $\pm 4.4$       | $\pm 4.7$ |                 | V                            |
| Output Current                                 | $I_{OUT}$    | $R_L = 0\Omega$  |                 | 1000      |                 | mA                           |

**Electrical Specifications (Continued)**  $V_S = 12V$ ,  $R_F = 750\Omega$ ,  $R_{L-DIFF} = 50\Omega$ ,  $T_A = +25^\circ C$ , unless otherwise specified.

| PARAMETER                             | SYMBOL                     | CONDITIONS                                 | MIN<br>(Note 8) | TYP | MAX<br>(Note 8) | UNIT    |
|---------------------------------------|----------------------------|--|-----------------|-----|-----------------|---------|
| <b>SUPPLY</b>                         |                            |  |                 |     |                 |         |
| Supply Voltage                        | $V_S$                      | Single supply                              | 4.5             |     | 13.2            | V       |
| Positive Supply Current per Amplifier | $I_{S+}$ (Full Bias)       | All outputs at 0V, $C_0 = C_1 = 0V$        | 13              | 15  | 19              | mA      |
| Positive Supply Current per Amplifier | $I_{S+}$ (Medium Bias)     | All outputs at 0V, $C_0 = 5V$ , $C_1 = 0V$ |                 | 11  |                 | mA      |
| Positive Supply Current per Amplifier | $I_{S+}$ (Low Bias)        | All outputs at 0V, $C_0 = 0V$ , $C_1 = 5V$ |                 | 6.0 |                 | mA      |
| Positive Supply Current per Amplifier | $I_{S+}$ (Power-down)      | All outputs at 0V, $C_0 = C_1 = 5V$        |                 | 0.6 | 1.0             | mA      |
| $C_0$ , $C_1$ Input Current, High     | $I_{INH}$ , $C_0$ or $C_1$ | $C_0$ , $C_1 = 6V$                         | 100             | 175 | 250             | $\mu A$ |
| $C_0$ , $C_1$ Input Current, Low      | $I_{INL}$ , $C_0$ or $C_1$ | $C_0$ , $C_1 = 0V$                         | -5              |     | +5              | $\mu A$ |
| $C_0$ , $C_1$ Input Voltage, High     | $V_{INH}$ , $C_0$ or $C_1$ |  | 2.0             |     |                 | V       |
| $C_0$ , $C_1$ Input Voltage, Low      | $V_{INL}$ , $C_0$ or $C_1$ |  |                 |     | 0.8             | V       |

**NOTE:**

8. Compliance to datasheet limits is assured by one or more methods: production test, characterization and/or design. Unless otherwise noted, all tests are at the specified temperature and are pulsed tests, therefore:  $T_J = T_C = T_A$

# Typical Performance Curves

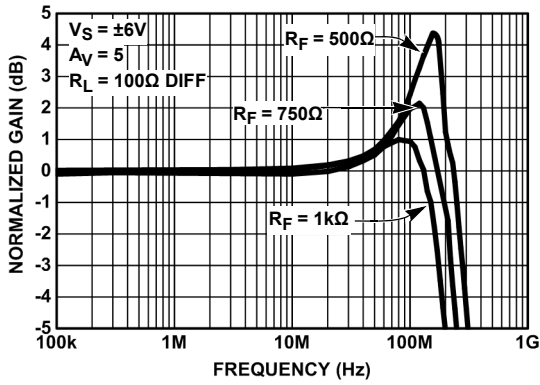

FIGURE 2. DIFFERENTIAL FREQUENCY RESPONSE WITH VARIOUS  $R_F$  (FULL BIAS MODE)

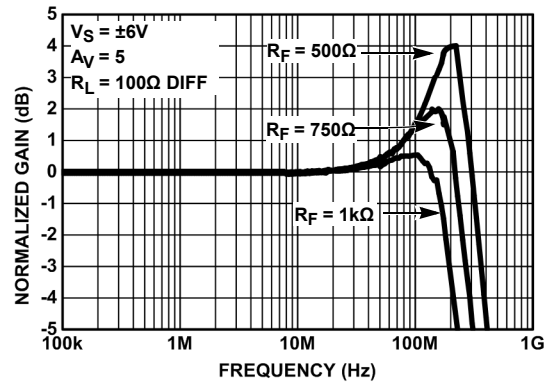

FIGURE 3. DIFFERENTIAL FREQUENCY RESPONSE WITH VARIOUS  $R_F$  (MEDIUM BIAS MODE)

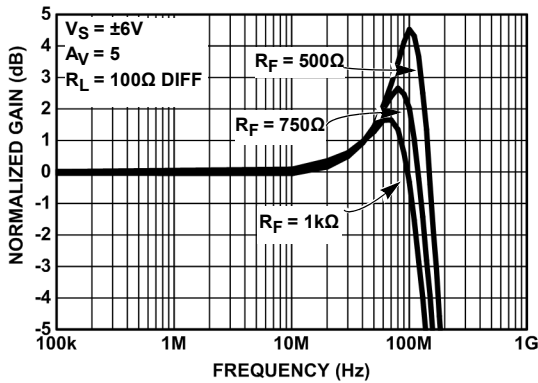

FIGURE 4. DIFFERENTIAL FREQUENCY RESPONSE WITH VARIOUS  $R_F$  (LOW BIAS MODE)

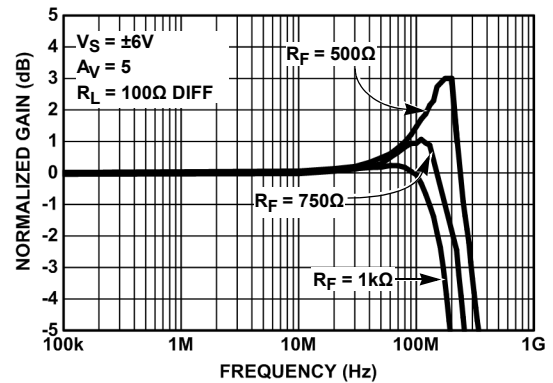

FIGURE 5. DIFFERENTIAL FREQUENCY RESPONSE WITH VARIOUS  $R_F$  (FULL BIAS MODE)

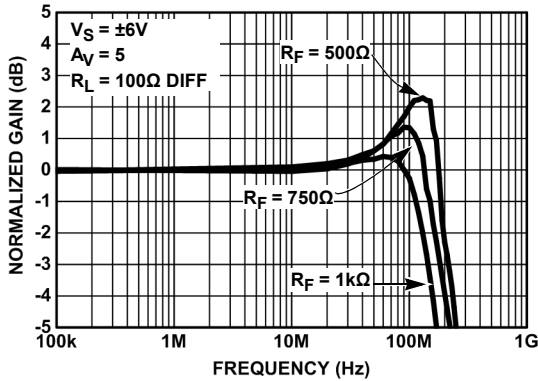

FIGURE 6. DIFFERENTIAL FREQUENCY RESPONSE WITH VARIOUS  $R_F$  (MEDIUM BIAS MODE)

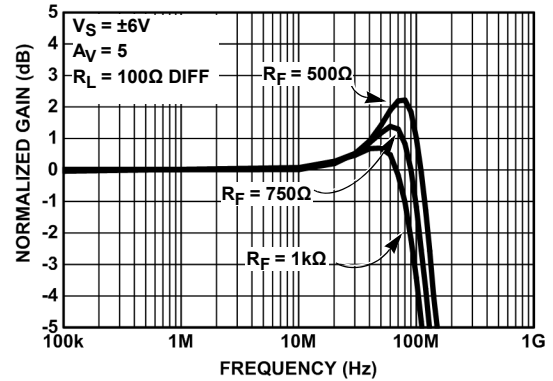

FIGURE 7. DIFFERENTIAL FREQUENCY RESPONSE WITH VARIOUS  $R_F$  (LOW BIAS MODE)

## Typical Performance Curves (Continued)

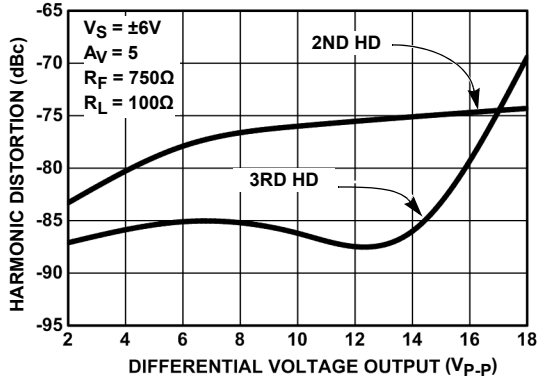

FIGURE 8. HARMONIC DISTORTION AT 2MHZ

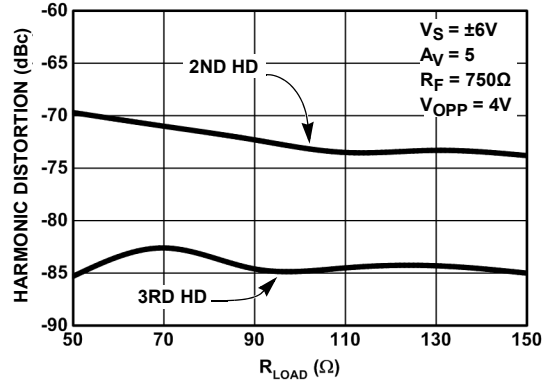

FIGURE 9. 2ND AND 3RD HARMONIC DISTORTION vs R<sub>LOAD</sub> AT 2MHZ

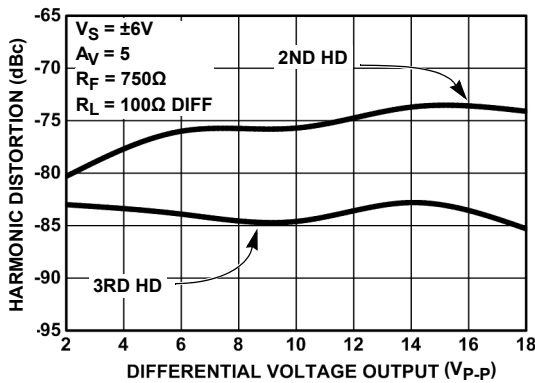

FIGURE 10. HARMONIC DISTORTION AT 3MHZ

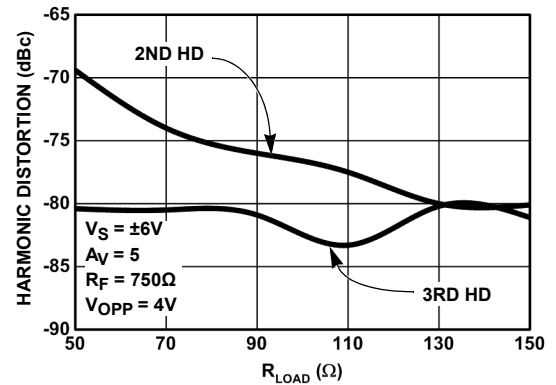

FIGURE 11. 2ND AND 3RD HARMONIC DISTORTION vs R<sub>LOAD</sub> AT 3MHZ

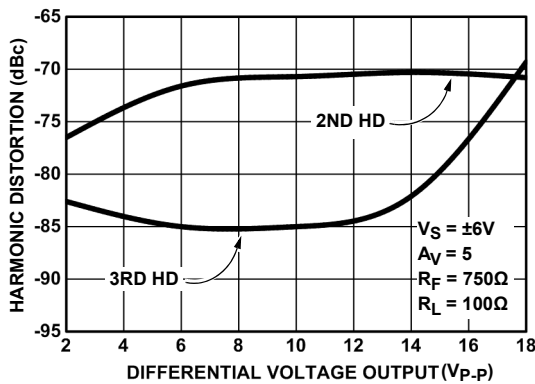

FIGURE 12. HARMONIC DISTORTION AT 5MHZ

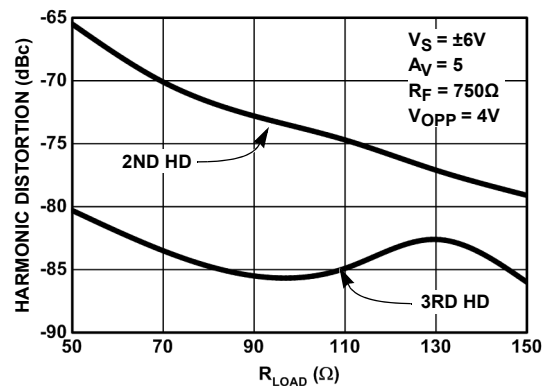

FIGURE 13. 2ND AND 3RD HARMONIC DISTORTION vs R<sub>LOAD</sub> AT 5MHZ

## Typical Performance Curves (Continued)

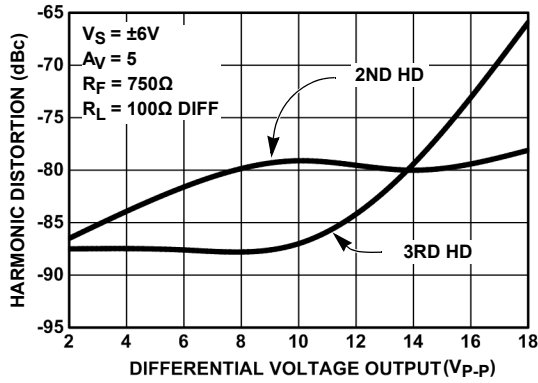

FIGURE 14. HARMONIC DISTORTION AT 10MHz

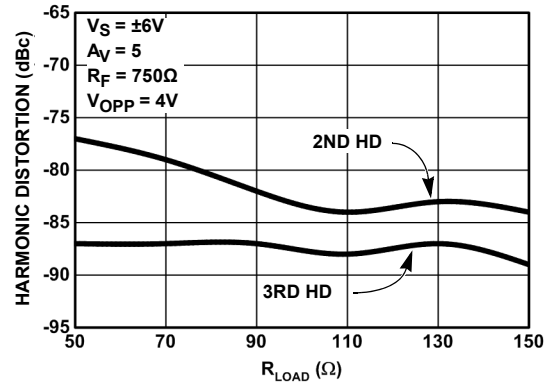

FIGURE 15. 2ND AND 3RD HARMONIC DISTORTION vs  $R_{LOAD}$  AT 10MHz

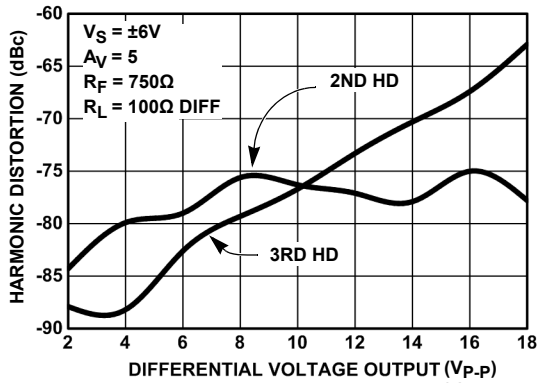

FIGURE 16. HARMONIC DISTORTION AT 17MHz

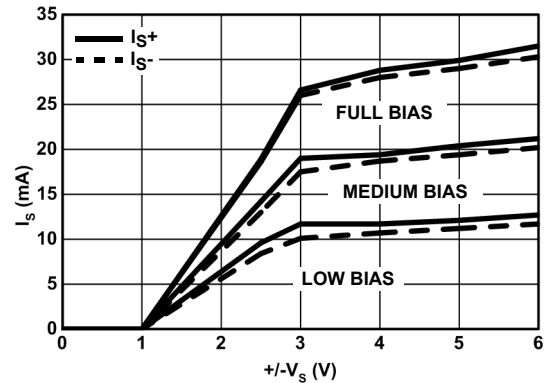

FIGURE 17. SUPPLY CURRENT vs SUPPLY VOLTAGE

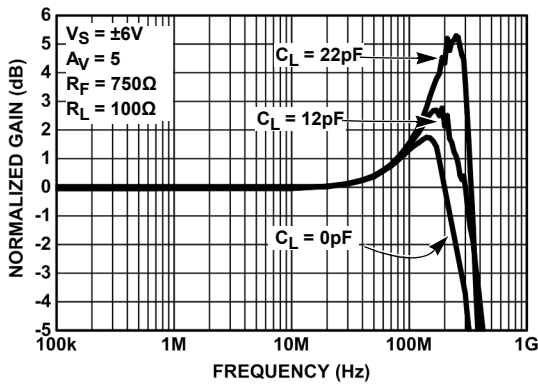

FIGURE 18. FREQUENCY RESPONSE WITH VARIOUS  $C_L$  (FULL BIAS MODE)

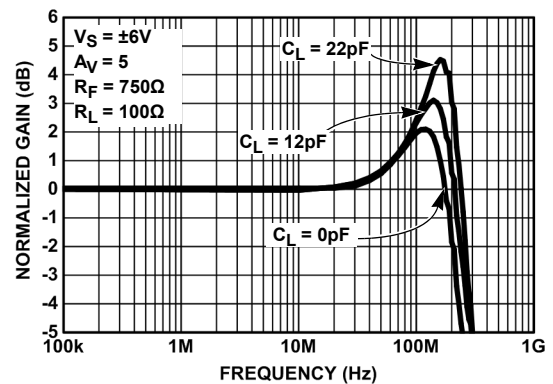

FIGURE 19. FREQUENCY RESPONSE vs VARIOUS  $C_L$  (MEDIUM BIAS MODE)



## Typical Performance Curves (Continued)

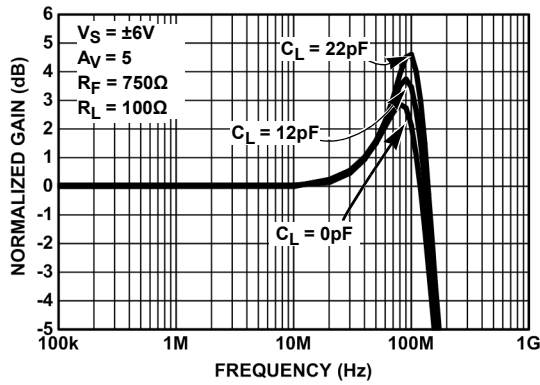

FIGURE 20. FREQUENCY RESPONSE WITH VARIOUS  $C_L$  (LOW BIAS MODE)

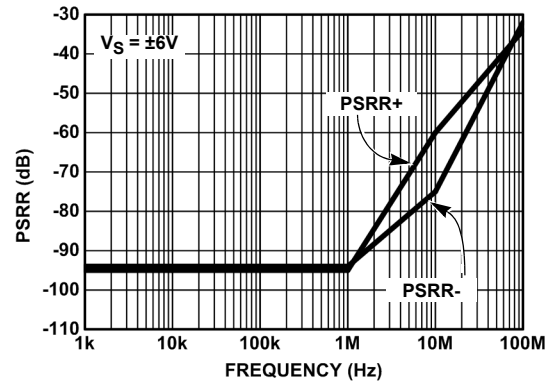

FIGURE 21. PSRR vs FREQUENCY

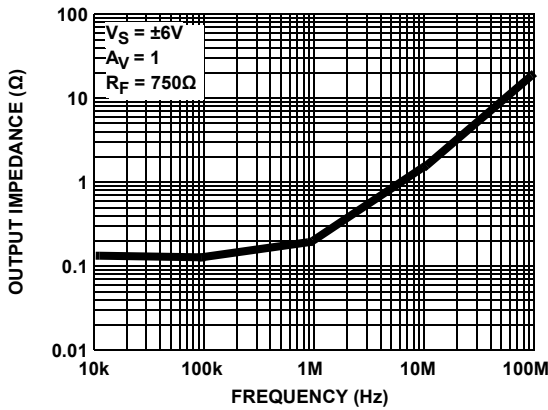

FIGURE 22. OUTPUT IMPEDANCE vs FREQUENCY

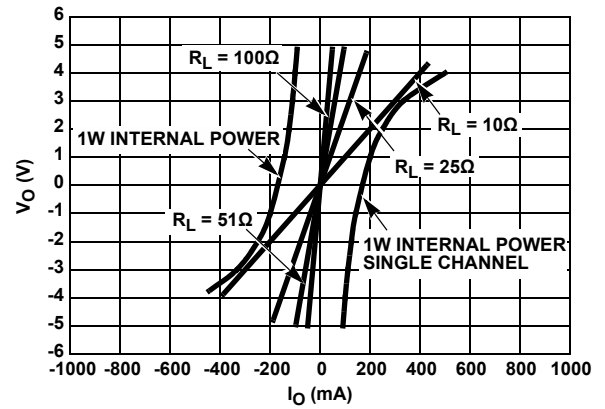

FIGURE 23. OUTPUT VOLTAGE AND CURRENT LIMITATIONS

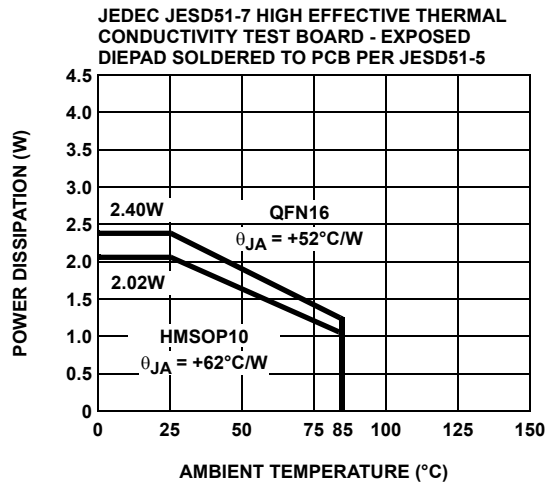

FIGURE 24. PACKAGE POWER DISSIPATION vs AMBIENT TEMPERATURE

## Applications Information

### Product Description

The ISL1557 is a dual operational amplifier designed for line driving in DMT ADSL2+ and VDSL solutions. It is a dual current mode feedback amplifier with low distortion while drawing moderately low supply current. It is built using the Renesas proprietary complimentary bipolar process and is offered in industry standard pinouts. Due to the current feedback architecture, the ISL1557 closed-loop 3dB bandwidth is dependent on the value of the feedback resistor. First, select the desired bandwidth by choosing the feedback resistor,  $R_F$ , then set the gain by choosing the gain resistor,  $R_G$ . The curves at the beginning of the “Typical Performance Curves” section, on [page 6](#), show the effect of varying both  $R_F$  and  $R_G$ . The 3dB bandwidth is somewhat dependent on the power supply voltage.

### Power Supply Bypassing and Printed Circuit Board Layout

As with any high frequency device, good printed circuit board layout is necessary for optimum performance. Ground plane construction is highly recommended. Lead lengths should be as short as possible (below 0.25”). The power supply pins must be well bypassed to reduce the risk of oscillation. A 4.7 $\mu$ F tantalum capacitor in parallel with a 0.1 $\mu$ F ceramic capacitor is adequate for each supply pin. During power-up, it is necessary to limit the slew rate of the rising power supply to within 1V/ $\mu$ s. If the power supply rising time is undetermined, a series 10 $\Omega$  resistor on the power supply line can be used to ensure the proper power supply rise time.

For good AC performance, parasitic capacitances should be kept to a minimum, especially at the inverting input. This implies keeping the ground plane away from this pin. Carbon resistors are acceptable, but avoid using wire-wound resistors because of their parasitic inductance. Similarly, capacitors should be low inductance for best performance.

### Capacitance at the Inverting Input

Due to the topology of the current feedback amplifier, stray capacitance at the inverting input will effect the AC and transient

performance of the ISL1557 when operating in the non-inverting configuration.

In the inverting gain mode, added capacitance at the inverting input has little effect because this point is at a virtual ground and stray capacitance is therefore not “detected” by the amplifier.

### Feedback Resistor Values

The ISL1557 has been designed and specified with  $R_F = 750\Omega$  for  $A_V = +5$ . This value of feedback resistor yields extremely flat frequency response with 1dB peaking out to 250MHz. As with all current feedback amplifiers, wider bandwidth, at the expense of slight peaking, can be obtained by reducing the value of the feedback resistor. Inversely, larger values of feedback resistor will cause rolloff to occur at a lower frequency. See the curves in the “Typical Performance Curves” section, beginning on [page 6](#), which shows 3dB bandwidth and peaking vs frequency for various feedback resistors and various supply voltages.

### Bandwidth vs Temperature

Whereas many amplifier's supply current and consequently 3dB bandwidth drop off at high temperature, the ISL1557 is designed to have little supply current variations with temperature. An immediate benefit is the 3dB bandwidth does not drop off drastically with temperature.

### Supply Voltage Range

The ISL1557IRZ is designed to operate with supply voltages from  $\pm 2.25V$  to  $\pm 6V$  nominal. Optimum bandwidth, slew rate, and video characteristics are obtained at higher supply voltages.

### Single Supply Operation

If a single supply is desired, values from +4.5V to +12V nominal can be used as long as the input common mode range is not exceeded. When using a single supply, be sure to either:

- DC bias the inputs at an appropriate common mode voltage and AC couple the signal ([Figure 25](#)), or:
- Ensure the driving signal is within the common mode range of the ISL1557. The ISL1557IUEZ must be used in single supply applications.

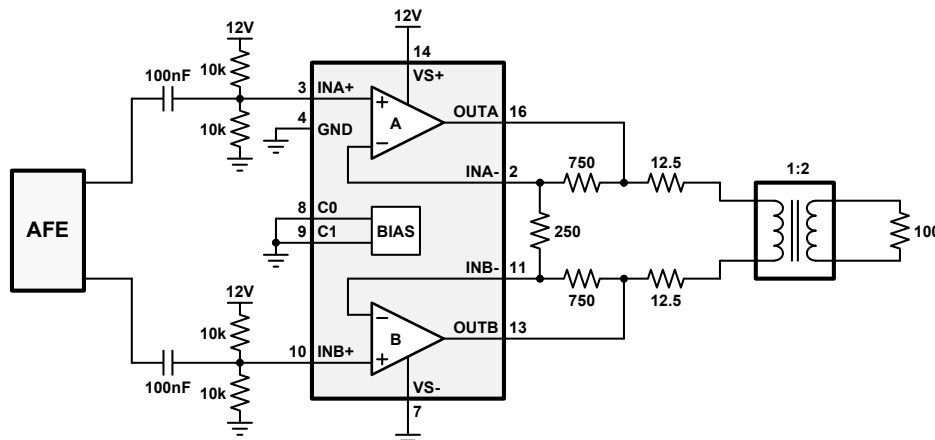

FIGURE 25. SINGLE SUPPLY OPERATION WITH INPUT COMMON-MODE BIASING

**ADSL CPE Applications**

The ISL1557 is designed as a line driver for ADSL CPE modems. It is capable of outputting 450mA of output current with a typical supply voltage headroom of 1.3V. It can achieve -85dBc of distortion at low 7.1mA of supply current per amplifier.

The average line power requirement for the ADSL CPE application is 14.5dBm (28mW) into a 100Ω line. The average

line voltage is  $1.67V_{RMS}$ . The ADSL DMT peak to average ratio (crest factor) of 5.3 implies peak voltage of 7.5V into the line. Using a differential drive configuration and transformer coupling with standard back termination, a transformer ratio of 1:2 is selected. The circuit configuration is shown in [Figure 26](#).

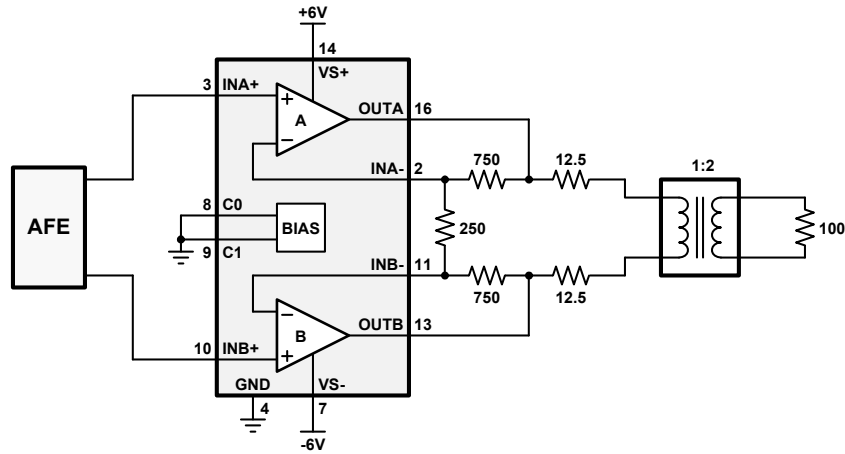

**FIGURE 26. ADSL CPE DRIVER**

**Revision History** The revision history provided is for informational purposes only and is believed to be accurate, but not warranted. Please visit our website to make sure you have the latest revision.

| DATE        | REVISION | CHANGE  |
|-------------|----------|---|
| Nov 7, 2019 | FN7522.5 | Updated links throughout.<br>Replaced POD MDP0050 with POD M10.118B in the ordering information table and the Package Outline Drawings section.<br>Updated disclaimer   |
| May 2, 2018 | FN7522.4 | Added Figure 1.<br>Added ISL1557FRZ part information throughout document.<br>Added Pin Description table<br>Added Table 1.<br>Added Theta JA and JC information under the Thermal Information section.<br>Updated Figures 8 through 16.<br>Added Figure 25.<br>Updated Figure 26. |
| Apr 6, 2018 | FN7522.3 | Added Related Literature section.<br>Updated Ordering information table.<br>Added Note 3.<br>Moved and updated Note 4 to end of EC table.<br>Added Revision History.<br>Replaced POD MDP0046 (multiple lead counts) with L16.4x4H POD.<br>Updated Disclaimer.                     |

# Package Outline Drawings

For the most recent package outline drawing, see [L16.4x4H](#).

L16.4x4H  
 16 LEAD QUAD FLAT NO-LEAD PLASTIC PACKAGE  
 Rev 0, 1/12

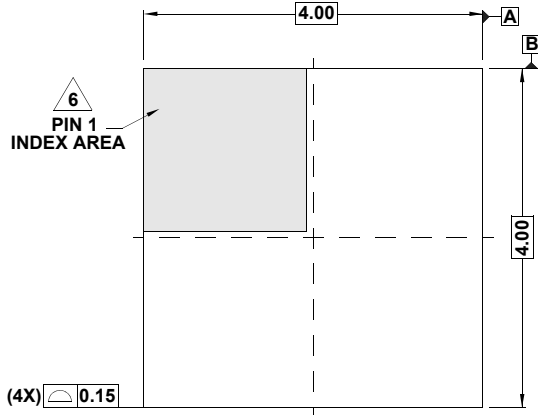

**TOP VIEW**

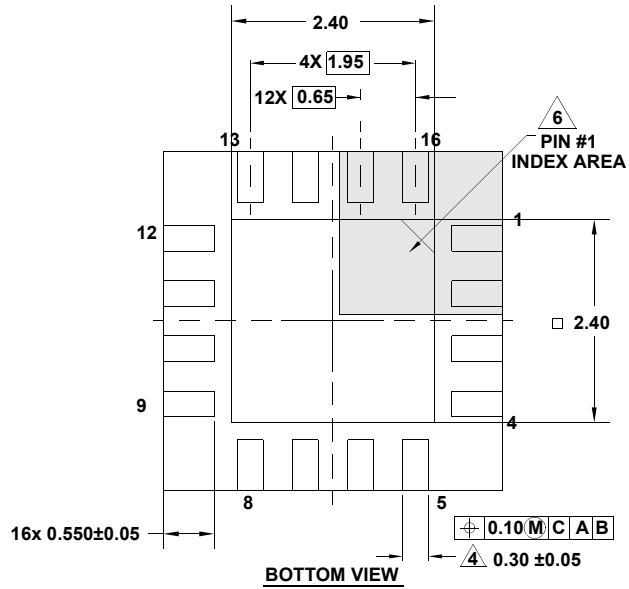

**BOTTOM VIEW**

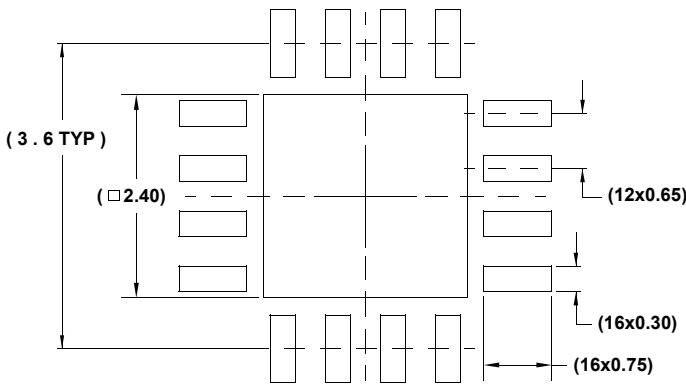

**TYPICAL RECOMMENDED LAND PATTERN**

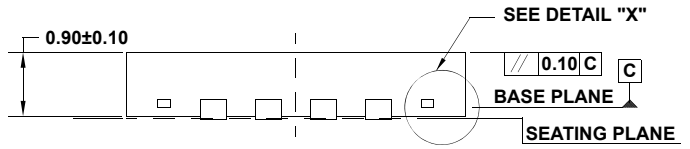

**SIDE VIEW**

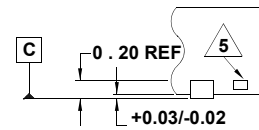

**DETAIL "X"**

**NOTES:**

1. Dimensions are in millimeters.  
Dimensions in ( ) for Reference Only.
2. Dimensioning and tolerancing conform to ASME Y14.5m-1994.
3. Unless otherwise specified, tolerance : Decimal ± 0.05
4. Dimension applies to the metallized terminal and is measured between 0.15mm and 0.30mm from the terminal tip.
5. Tiebar shown (if present) is a non-functional feature.
6. The configuration of the pin #1 identifier is optional, but must be located within the zone indicated. The pin #1 identifier may be either a mold or mark feature.

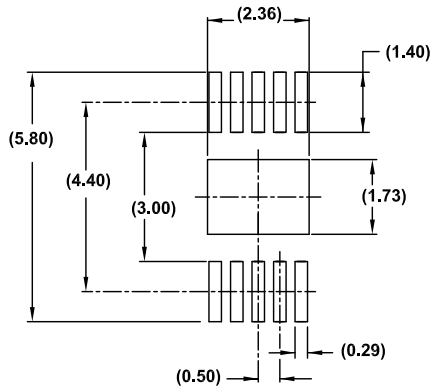
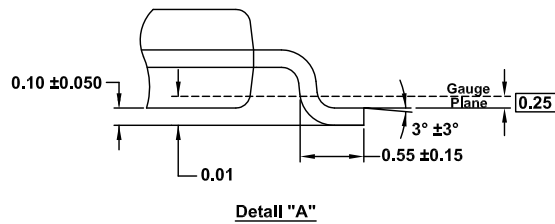
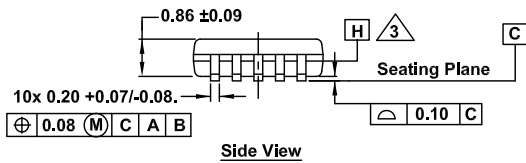
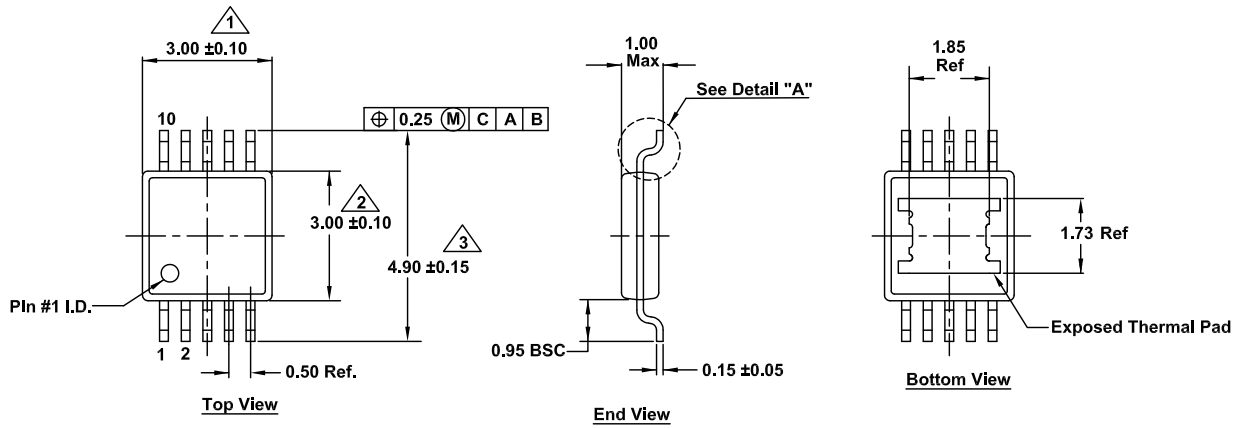

Recommended Land Pattern

Notes:

- 1. Plastic or metal protrusions of 0.15 maximum per side are not included.
- 2. Plastic Interlead protrusions of 0.25 maximum per side are not included.
- 3. Package body length and width dimensions are measured at Datum Plane "H".
- 4. Dimensioning and tolerancing conform to ASME Y14.5M-1994.
- 5. Dimensions are in millimeters.  
 Dimensions in ( ) for reference only.

## Notice

1. Descriptions of circuits, software and other related information in this document are provided only to illustrate the operation of semiconductor products and application examples. You are fully responsible for the incorporation or any other use of the circuits, software, and information in the design of your product or system. Renesas Electronics disclaims any and all liability for any losses and damages incurred by you or third parties arising from the use of these circuits, software, or information.
  2. Renesas Electronics hereby expressly disclaims any warranties against and liability for infringement or any other claims involving patents, copyrights, or other intellectual property rights of third parties, by or arising from the use of Renesas Electronics products or technical information described in this document, including but not limited to, the product data, drawings, charts, programs, algorithms, and application examples.
  3. No license, express, implied or otherwise, is granted hereby under any patents, copyrights or other intellectual property rights of Renesas Electronics or others.
  4. You shall not alter, modify, copy, or reverse engineer any Renesas Electronics product, whether in whole or in part. Renesas Electronics disclaims any and all liability for any losses or damages incurred by you or third parties arising from such alteration, modification, copying or reverse engineering.
  5. Renesas Electronics products are classified according to the following two quality grades: "Standard" and "High Quality". The intended applications for each Renesas Electronics product depends on the product's quality grade, as indicated below.
    - "Standard": Computers; office equipment; communications equipment; test and measurement equipment; audio and visual equipment; home electronic appliances; machine tools; personal electronic equipment; industrial robots; etc.
    - "High Quality": Transportation equipment (automobiles, trains, ships, etc.); traffic control (traffic lights); large-scale communication equipment; key financial terminal systems; safety control equipment; etc.Unless expressly designated as a high reliability product or a product for harsh environments in a Renesas Electronics data sheet or other Renesas Electronics document, Renesas Electronics products are not intended or authorized for use in products or systems that may pose a direct threat to human life or bodily injury (artificial life support devices or systems; surgical implantations; etc.), or may cause serious property damage (space system; undersea repeaters; nuclear power control systems; aircraft control systems; key plant systems; military equipment; etc.). Renesas Electronics disclaims any and all liability for any damages or losses incurred by you or any third parties arising from the use of any Renesas Electronics product that is inconsistent with any Renesas Electronics data sheet, user's manual or other Renesas Electronics document.
  6. When using Renesas Electronics products, refer to the latest product information (data sheets, user's manuals, application notes, "General Notes for Handling and Using Semiconductor Devices" in the reliability handbook, etc.), and ensure that usage conditions are within the ranges specified by Renesas Electronics with respect to maximum ratings, operating power supply voltage range, heat dissipation characteristics, installation, etc. Renesas Electronics disclaims any and all liability for any malfunctions, failure or accident arising out of the use of Renesas Electronics products outside of such specified ranges.
  7. Although Renesas Electronics endeavors to improve the quality and reliability of Renesas Electronics products, semiconductor products have specific characteristics, such as the occurrence of failure at a certain rate and malfunctions under certain use conditions. Unless designated as a high reliability product or a product for harsh environments in a Renesas Electronics data sheet or other Renesas Electronics document, Renesas Electronics products are not subject to radiation resistance design. You are responsible for implementing safety measures to guard against the possibility of bodily injury, injury or damage caused by fire, and/or danger to the public in the event of a failure or malfunction of Renesas Electronics products, such as safety design for hardware and software, including but not limited to redundancy, fire control and malfunction prevention, appropriate treatment for aging degradation or any other appropriate measures. Because the evaluation of microcomputer software alone is very difficult and impractical, you are responsible for evaluating the safety of the final products or systems manufactured by you.
  8. Please contact a Renesas Electronics sales office for details as to environmental matters such as the environmental compatibility of each Renesas Electronics product. You are responsible for carefully and sufficiently investigating applicable laws and regulations that regulate the inclusion or use of controlled substances, including without limitation, the EU RoHS Directive, and using Renesas Electronics products in compliance with all these applicable laws and regulations. Renesas Electronics disclaims any and all liability for damages or losses occurring as a result of your noncompliance with applicable laws and regulations.
  9. Renesas Electronics products and technologies shall not be used for or incorporated into any products or systems whose manufacture, use, or sale is prohibited under any applicable domestic or foreign laws or regulations. You shall comply with any applicable export control laws and regulations promulgated and administered by the governments of any countries asserting jurisdiction over the parties or transactions.
  10. It is the responsibility of the buyer or distributor of Renesas Electronics products, or any other party who distributes, disposes of, or otherwise sells or transfers the product to a third party, to notify such third party in advance of the contents and conditions set forth in this document.
  11. This document shall not be reprinted, reproduced or duplicated in any form, in whole or in part, without prior written consent of Renesas Electronics.
  12. Please contact a Renesas Electronics sales office if you have any questions regarding the information contained in this document or Renesas Electronics products.
- (Note1) "Renesas Electronics" as used in this document means Renesas Electronics Corporation and also includes its directly or indirectly controlled subsidiaries.
- (Note2) "Renesas Electronics product(s)" means any product developed or manufactured by or for Renesas Electronics.

(Rev.4.0-1 November 2017)

## Corporate Headquarters

TOYOSU FORESIA, 3-2-24 Toyosu,  
Koto-ku, Tokyo 135-0061, Japan  
[www.renesas.com](http://www.renesas.com)

## Contact Information

For further information on a product, technology, the most up-to-date version of a document, or your nearest sales office, please visit:  
[www.renesas.com/contact/](http://www.renesas.com/contact/)

## Trademarks

Renesas and the Renesas logo are trademarks of Renesas Electronics Corporation. All trademarks and registered trademarks are the property of their respective owners.



Компания «ЭлектроПласт» предлагает заключение долгосрочных отношений при поставках импортных электронных компонентов на взаимовыгодных условиях!

Наши преимущества:

- Оперативные поставки широкого спектра электронных компонентов отечественного и импортного производства напрямую от производителей и с крупнейших мировых складов;
- Поставка более 17-ти миллионов наименований электронных компонентов;
- Поставка сложных, дефицитных, либо снятых с производства позиций;
- Оперативные сроки поставки под заказ (от 5 рабочих дней);
- Экспресс доставка в любую точку России;
- Техническая поддержка проекта, помощь в подборе аналогов, поставка прототипов;
- Система менеджмента качества сертифицирована по Международному стандарту ISO 9001;
- Лицензия ФСБ на осуществление работ с использованием сведений, составляющих государственную тайну;
- Поставка специализированных компонентов (Xilinx, Altera, Analog Devices, Intersil, Interpoint, Microsemi, Aeroflex, Peregrine, Syfer, Eurofarad, Texas Instrument, Miteq, Cobham, E2V, MA-COM, Hittite, Mini-Circuits, General Dynamics и др.);

Помимо этого, одним из направлений компании «ЭлектроПласт» является направление «Источники питания». Мы предлагаем Вам помощь Конструкторского отдела:

- Подбор оптимального решения, техническое обоснование при выборе компонента;
- Подбор аналогов;
- Консультации по применению компонента;
- Поставка образцов и прототипов;
- Техническая поддержка проекта;
- Защита от снятия компонента с производства.



#### Как с нами связаться

**Телефон:** 8 (812) 309 58 32 (многоканальный)

**Факс:** 8 (812) 320-02-42

**Электронная почта:** [org@eplast1.ru](mailto:org@eplast1.ru)

**Адрес:** 198099, г. Санкт-Петербург, ул. Калинина, дом 2, корпус 4, литера А.