

LOC		DIST		REVISIONS			
ES	00	P	LTH	DESCRIPTION	DATE	DWN	APVD
		J9		REV PER ECR-12-020199	22NOV2012	CZ	SZ



THIS DRAWING IS A CONTROLLED DOCUMENT.		DWN D. ZHU	Z0DEC2007		TE Connectivity
DIMENSIONS: INCHES		CHK S. ZHAO	Z0DEC2007		NAME VER RECEP ASSEMBLY SHORT GUIDES, PRESS FIT MULTI-BEAM XLE
TOLERANCES UNLESS OTHERWISE SPECIFIED:		APVD S. ZHAO	-	PRODUCT SPEC	
0 PLC ± .01		PRODUCT SPEC		108-2292	
2 PLC ± .01		APPLICATION SPEC		114-13251	
3 PLC ± .005		WEIGHT		A100779C=6450860	
4 PLC ± .0020		SCALE		N/A	
ANGLES ± .2°		SHEET		1 OF 28	
FINISH		REV		K2	
MATERIAL		CUSTOMER DRAWING		SCALE N/A SHEET 1 OF 28 REV K2	

LOC	DIST	REV	DATE	BY	APPR
ES	00				

- 1 "AMP", PART NUMBER AND DATE CODE TO BE MARKED IN AREA SHOWN
PARTS UNDER 2.00 LONG MAY BE MARKED ON BOTH SIDES
- 2 MATERIAL: HOUSING - GLASS FILLED HIGH TEMP THERMO PLASTIC, UL94 V-0, BLACK.
SIGNAL CONTACT - HIGH CONDUCTIVITY COPPER ALLOY
POWER CONTACT - HIGH CONDUCTIVITY COPPER ALLOY
LP CONTACT - HIGH CONDUCTIVITY COPPER ALLOY
- 3 CONTACT PLATING - NOBLE METAL PLATING ON CONTACT FUNCTIONAL AREA
OF POWER AND SIGNAL CONTACTS
- 4 MECHANICAL CONNECTOR KEEP OUT ZONE
- 5 DATUM AND BASIC DIMENSIONS ESTABLISHED BY CUSTOMER
- 6 PCB - ALL HOLE DIAMETERS ARE FINISHED HOLE SIZES
- 7 PCB - 0.0453 ±.0010 DRILLED HOLES PLATED WITH .0003 MIN Sn
OVER .001 TO .003 Cu PLATING TO ACHIEVE A .040 HOLE
- 8 FOR P/S/LP CONFIGURATION, PLEASE REFER TO SHEET 3.
- 9 FOR LP/S/P CONFIGURATION, PLEASE REFER TO SHEET 3.
- 10 VARIABLE DIMENSIONS SHOW ON TABLE.
- 11 FOR LP/S/LP CONFIGURATION, PLEASE REFER TO SHEET 3.
- 12 SPECIAL DIMENSIONS SEE SHEET 3
- 13 RECOMMEND USING CUSTOMER SUPPLIED SCREWS TO SECURE TO BOARD
TYCO P/N: 19024-2. RECOMMEND TORQUE IS TBD.
ASSUMING A CARD THICKNESS OF TBD, FINAL SCREW LENGTH AND CARD THICKNESS ARE FACTORS TO BE
CONSIDERED IF APPLYING A SCREW FOR AN APPLICATION AND MAY VARY FOR EACH APPLICATION.

W	U	K	S	T	D	R	L	DESCRIPTION	PART NUMBER
1.850	.250	.250	.170	1.690	.425	1.100	2.040	2P + 24S + 2P	5-6450860-2
1.185	-	-	.1025	1.025	.2725	.705	1.375	2LP + 16S + 2LP	4-6450860-8
2.850	.250	.250	.170	2.690	.925	1.600	3.040	4P + 24S + 4P	4-6450860-7
2.150	.250	.250	.170	1.990	.475	1.400	2.340	2P + 32S + 2P	4-6450860-6
2.705	.115	.170	.170	2.545	1.800	2.1575	2.895	3ACP+3P+12S+2LP	4-6450860-5
4.450	.250	.250	.170	4.290	1.925	2.200	4.640	8P + 8S + 8P	4-6450860-4
1.400	.250	.250	.145	1.240	.425	.700	1.590	2P + 8S + 2P	4-6450860-3
1.330	.250	-	.1275	1.170	.2725	.5725	1.520	2LP + 8S + 2P	4-6450860-2
2.400	.200	.200	.145	2.240	.775	1.350	2.590	4HDP + 20S + 4HDP	4-6450860-1
1.350	-	-	.170	1.190	.175	.850	1.540	1P + 24S + 1P	4-6450860-0
1.360	-	.230	.1275	1.200	.4775	.8525	1.550	4LP + 12S + 1P	3-6450860-9
2.550	.250	.250	.170	2.390	.475	1.800	2.740	2P + 48S + 2P	3-6450860-6
3.850	.250	.250	.170	3.690	1.425	2.100	4.040	6P + 24S + 6P	3-6450860-5
1.075	-	-	.1025	.915	.2725	.480	1.265	2LP + 8S + 3LP	3-6450860-4
1.330	.250	-	.1275	1.170	.2725	.5725	1.520	2LP + 8S + 2P	3-6450860-3
1.800	.250	.250	.220	1.640	.450	.950	1.990	2P + 16S + 2P	3-6450860-2
2.870	.230	.230	.1525	2.710	.6550	2.2125	3.060	4LP + 60S + 4LP	3-6450860-1
.975	-	-	.1025	.815	.2725	.380	1.165	2LP + 4S + 3LP	3-6450860-0
1.950	.250	.250	.170	1.790	.475	1.200	2.140	2P + 24S + 2P	2-6450860-9
2.550	.250	.250	.170	2.390	.925	1.300	2.740	4P + 12S + 4P	2-6450860-8
5.635	.250	.250	.170	5.475	.475	1.885	5.825	2P + 32S + 4LP + 14P	2-6450860-6
3.570	.250	.230	.1525	3.410	2.1125	2.8375	3.760	18LP + 24S + 2P	2-6450860-5
6.050	.250	.250	.145	5.890	1.950	3.850	6.240	8P + 72S + 8P	2-6450860-1
1.950	.250	.250	.170	1.790	.475	1.200	2.140	2P + 24S + 2P	2-6450860-0
3.350	.200	.200	.170	3.190	1.175	1.850	3.540	6HDP + 24S + 6HDP	1-6450860-7
-	.250	.230	.1275	2.205	.7325	1.4075	2.555	6LP + 24S + 3P	1-6450860-6
2.450	.200	.200	.170	2.290	.775	1.350	2.640	4HDP + 20S + 4HDP	1-6450860-5
2.150	.200	.200	.170	1.990	.775	1.050	2.340	4HDP + 8S + 4HDP	1-6450860-4
2.450	-	.250	.170	2.290	.925	1.200	2.640	4P + 8S + 4P	1-6450860-3
3.450	-	.250	.170	3.290	1.425	1.700	3.640	6P + 8S + 6P	1-6450860-2
2.800	.300	.250	.170	2.640	.925	1.700	2.990	4P + 28S + 3ACP	1-6450860-0
2.510	-	-	.170	2.350	.455	1.6875	2.700	1P+2LP+48S+2LP+1P	6450860-9
2.800	.300	.250	.170	2.640	.925	1.700	2.990	4P + 28S + 3ACP	6450860-7
2.425	.250	.300	.170	2.265	.500	1.175	2.615	2ACP + 24S + 4P	6450860-6
3.665	-	.230	.1025	3.505	.7325	1.4075	3.855	6LP + 24S + 10P	6450860-5
2.530	-	.250	.170	2.370	1.175	1.9825	2.720	5P + 32S + 2LP	6450860-4
5.545	.230	.250	.195	5.385	2.975	4.2325	5.735	12P + 48S + 8LP	6450860-3
5.200	.200	.300	.195	5.040	1.150	2.475	5.390	4ACP + 48S + 12HDP	6450860-2
.985	-	-	.1025	.825	.2725	.505	1.175	2LP + 8S + 2LP	6450860-1
D	T	S	K	U	W	R	L	DESCRIPTION	PART NUMBER

THIS DRAWING IS A CONTROLLED DOCUMENT.

DIMENSIONS: INCHES

TOLERANCES UNLESS OTHERWISE SPECIFIED:

0 PLC	±
1 PLC	±.01
2 PLC	±.005
3 PLC	±.002
4 PLC	±.002
ANGLES	±.002
FINISH	±.002

MATERIAL: - FINISH: -

OWN: D. ZHU Z0DEC2007
 CH: S. ZHAO Z0DEC2007
 AP: S. ZHAO
 PRODUCT SPEC: 108-2292
 APPLICATION SPEC: 114-13251
 WEIGHT: -
 CUSTOMER DRAWING

STE TE Connectivity

NAME: VER RECEPT ASSEMBLY SHORT GUIDES, PRESS FIT MULTI-BEAM XLE

SIZE: A1 CAGE CODE: 100779 DRAWING NO: 6450860

SCALE: N/A SHEET: 2 OF 28 REV: K2

LOC	DIST	REVISIONS					
ES	00	P	LTH	DESCRIPTION	DATE	DWN	APVD
-	-	-	-	SEE SHEET 1	-	-	-



FOR P/S/LP CONFIGURATION
 UNSPECIFIED DIMENSION REFER TO SHEET 1



FOR LP/S/P CONFIGURATION
 UNSPECIFIED DIMENSION REFER TO SHEET 1



FOR PART 2-6450860-6



FOR LP/S/LP(6450860-1 AND 3-6450860-0) CONFIGURATION
 UNSPECIFIED DIM REFER TO SHEET 1

THIS DRAWING IS A CONTROLLED DOCUMENT.		DWN: D. ZHU CHK: S. ZHAO APVD: S. ZHAO	20DEC2007 20DEC2007	TE Connectivity VER RECEP ASSEMBLY SHORT GUIDES, PRESS FIT MULTI-BEAM XLE
DIMENSIONS: INCHES	TOLERANCES UNLESS OTHERWISE SPECIFIED: 0 PLC ±. 1 PLC ±.01 2 PLC ±.01 3 PLC ±.005 4 PLC ±.0020 ANGLES ±.7°	PRODUCT SPEC: 108-2292 APPLICATION SPEC: 114-13251	SIZE: A1 CAGE CODE: 6450860 DRAWING NO: 100779	
MATERIAL: -	FINISH: -	WEIGHT: -	CUSTOMER DRAWING	SCALE: N/A SHEET 3 OF 28 REV: K2

LOC		DIST		REVISIONS			
ES	00	REV	DATE	BY	CHKD	APVD	
-	-	SEE SHEET 1	-	-	-	-	-

PART NUMBER	ROWS	POWER				SIGNAL					POWER		HD	
		P6	P5	P4	P3	6	5	4	3	2	1	P2		P1
6450860-6	D	GS	GS	GS	GS	AP	AP	AP	AP	AP	AP	GS	GS	HD
	C					AP	AP	AP	AP	AP	AP			
	B					AP	AP	AP	AP	AP	AP			
	A					AP	AP	AP	AP	AP	AP			
2ACP + 24S + 4P														

PART NUMBER	ROWS	LP2	LPI	SIGNAL								POWER					HD	
				8	7	6	5	4	3	2	1	P5	P4	P3	P2	P1		
6450860-4	D	LSI		AP	AP	AP	AP	AP	AP	AP	AP	AP	GS	GP	GS	GP	GP	HD
	C			AP	AP	AP	AP	AP	AP	AP	AP							
	B			AP	AP	AP	AP	AP	AP	AP	AP							
	A			AP	AP	AP	AP	AP	AP	AP	AP							
5P + 32S + 2LP																		

NO CONTACT LOADED



THIS DRAWING IS A CONTROLLED DOCUMENT.

DIMENSIONS: INCHES	TOLERANCES UNLESS OTHERWISE SPECIFIED: 0 PLC ±. 1 PLC ±.01 2 PLC ±.01 3 PLC ±.005 4 PLC ±.002 ANGLES ±.2°	FINISH	FINISH
-----------------------	---	--------	--------

OWN: D. ZHU	20DEC2007	TE Connectivity VER RECEP ASSEMBLY SHORT GUIDES, PRESS FIT MULTI-BEAM XLE
CHK: S. ZHAO	20DEC2007	
APVD: S. ZHAO		
NAME		
PRODUCT SPEC	108-2292	SIZE: CAGE CODE: DRAWING NO:
APPLICATION SPEC	114-13251	RESTRICTED TO:
WEIGHT		A100779C=6450860
CUSTOMER DRAWING	SCALE: N/A	SHEET 6 OF 28

LOC		DIST		REVISIONS			
ES	00	P	LTN	DESCRIPTION	DATE	DMN	APVD
-	-	-	-	SEE SHEET 1	-	-	-

PART NUMBER	ROWS	POWER										SIGNAL						POWER					
		P10	P9	P8	P7	P6	P5	P4	P3	P2	P1	6	5	4	3	2	1	LP6	LP5	LP4	LP3	LP2	LP1
6450860-5	D C B A	GS	GS	GS	GS	GS	GS	GS	GS	GS	GS	AP	AP	AP	AP	AP	AP	LSI	LSI	LSI	LSI	LSI	LSI
		GS	GS	GS	GS	GS	GS	GS	GS	GS	GS	AP	AP	AP	AP	AP	AP	LSI	LSI	LSI	LSI	LSI	LSI
		GS	GS	GS	GS	GS	GS	GS	GS	GS	GS	AP	AP	AP	AP	AP	AP	LSI	LSI	LSI	LSI	LSI	LSI
		GS	GS	GS	GS	GS	GS	GS	GS	GS	GS	AP	AP	AP	AP	AP	AP	LSI	LSI	LSI	LSI	LSI	LSI

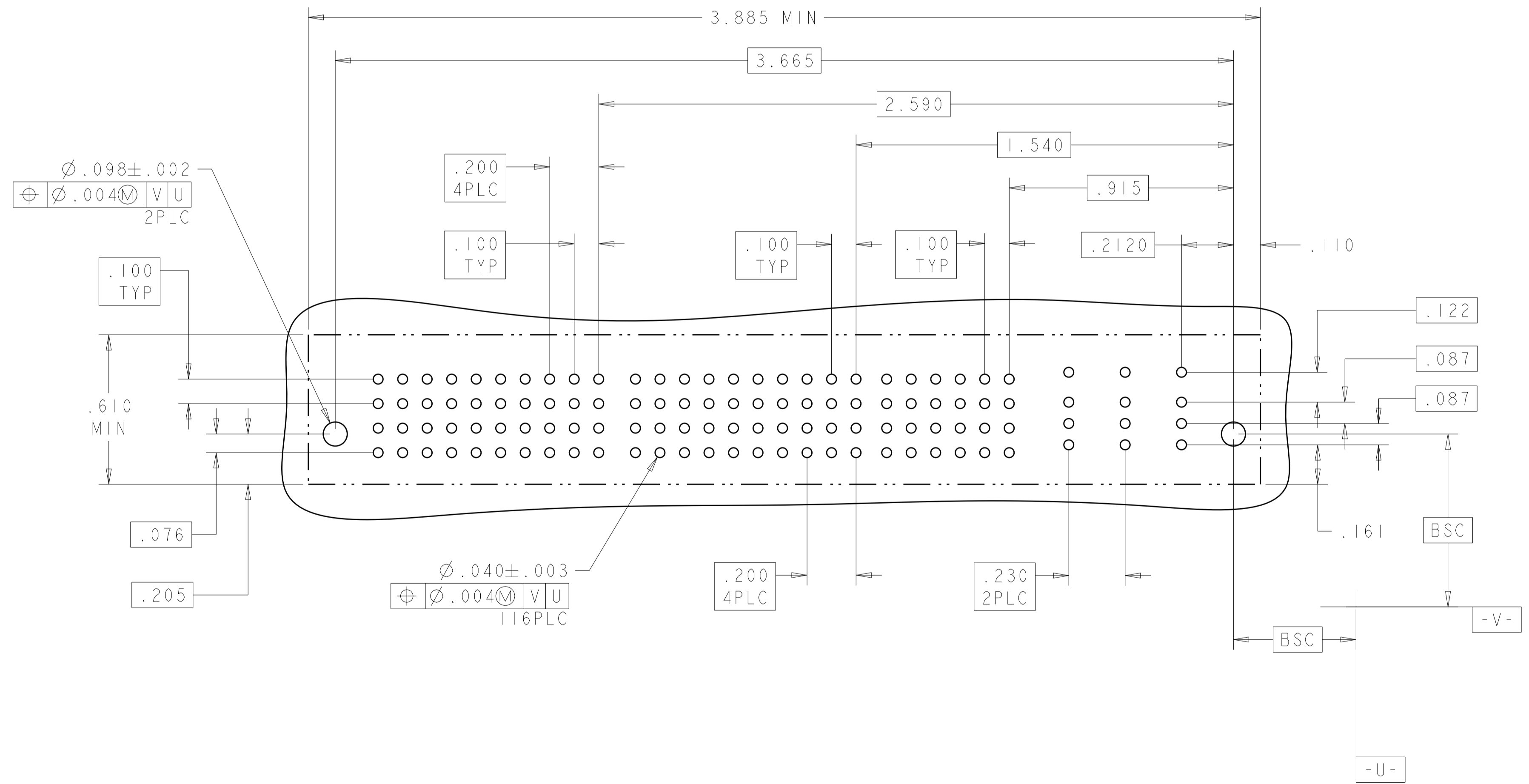

THIS DRAWING IS A CONTROLLED DOCUMENT.		DMN D. ZHU	20DEC2007	 TE Connectivity
DIMENSIONS: INCHES		CHK S. ZHAO	20DEC2007	
		TOLERANCES UNLESS OTHERWISE SPECIFIED: 0 PLC ± 1 PLC ±.01 2 PLC ±.01 3 PLC ±.005 4 PLC ±.0020 ANGLES ±.2°		NAME VER RECEP ASSEMBLY SHORT GUIDES, PRESS FIT MULTI-BEAM XLE
MATERIAL		APVD S. ZHAO	PRODUCT SPEC 108-2292 APPLICATION SPEC 114-13251	SIZE A100779
FINISH		WEIGHT -		CAGE CODE C=6450860
CUSTOMER DRAWING		SCALE N/A		SHEET 7 OF 28 REV K2

LOC	DIST	REVISIONS			
P	LTN	DESCRIPTION	DATE	DMN	APVD
-	-	SEE SHEET 1	-	-	-

PART NUMBER	ROWS	POWER				SIGNAL					POWER					
		P7	P6	P5		7	6	5	4	3	2	1	P4	P3	P2	P1
6450860-7	D C B A	HD	GS	GS			AP	AP	AP	AP	AP		GS	GS	GS	GS
							AP	AP	AP	AP	AP					
							AP	AP	AP	AP	AP					
							AP	AP	AP	AP	AP					
4P + 28S + 3ACP																

PART NUMBER	ROWS	POWER		SIGNAL		POWER	
		P4	P3	2	1	P2	P1
6450860-1	D C B A	LSI	LSI	AP	AP	LSI	LSI
				AP	AP		
				AP	AP		
				AP	AP		
2LP + 8S + 2LP							

NO CONTACTS LOADED



THIS DRAWING IS A CONTROLLED DOCUMENT.

DIMENSIONS: INCHES	TOLERANCES UNLESS OTHERWISE SPECIFIED: 0 PLC ±. 1 PLC ±.01 2 PLC ±.01 3 PLC ±.005 4 PLC ±.0020 ANGLES ±.2°	FINISH	DMN: D. ZHU CHK: S. ZHAO APVD: S. ZHAO	PRODUCT SPEC: 108-2292 APPLICATION SPEC: 114-13251	DATE: 20DEC2007	REV: 2
-----------------------	--	--------	--	---	-----------------	--------

MATERIAL: -

WEIGHT: -



VER RECEP ASSEMBLY
 SHORT GUIDES, PRESS FIT
 MULTI-BEAM XLE

SIZE: A1
 CAGE CODE: 100779
 DRAWING NO: 6450860

LOC	DIST	REVISIONS				
ES	00	REV	DATE	BY	APPV	
		1				
		SEE SHEET 1				

PART NUMBER	ROWS	POWER			SIGNAL										POWER					
		P2	LP4	LP3	12	11	10	9	8	7	6	5	4	3	2	1	LP2	LPI	PI	
6450860-9	D	GP	LSI	LSI	AP	AP	AP	AP	AP	AP	AP	AP	AP	AP	AP	AP	AP	LSI	LSI	GP
	C				AP	AP	AP	AP	AP	AP	AP	AP	AP	AP	AP	AP	AP	LSI	LSI	GP
	B				AP	AP	AP	AP	AP	AP	AP	AP	AP	AP	AP	AP	AP	LSI	LSI	GP
	A				AP	AP	AP	AP	AP	AP	AP	AP	AP	AP	AP	AP	AP	LSI	LSI	GP
IP + 2LP + 48S + 2LP + IP																				

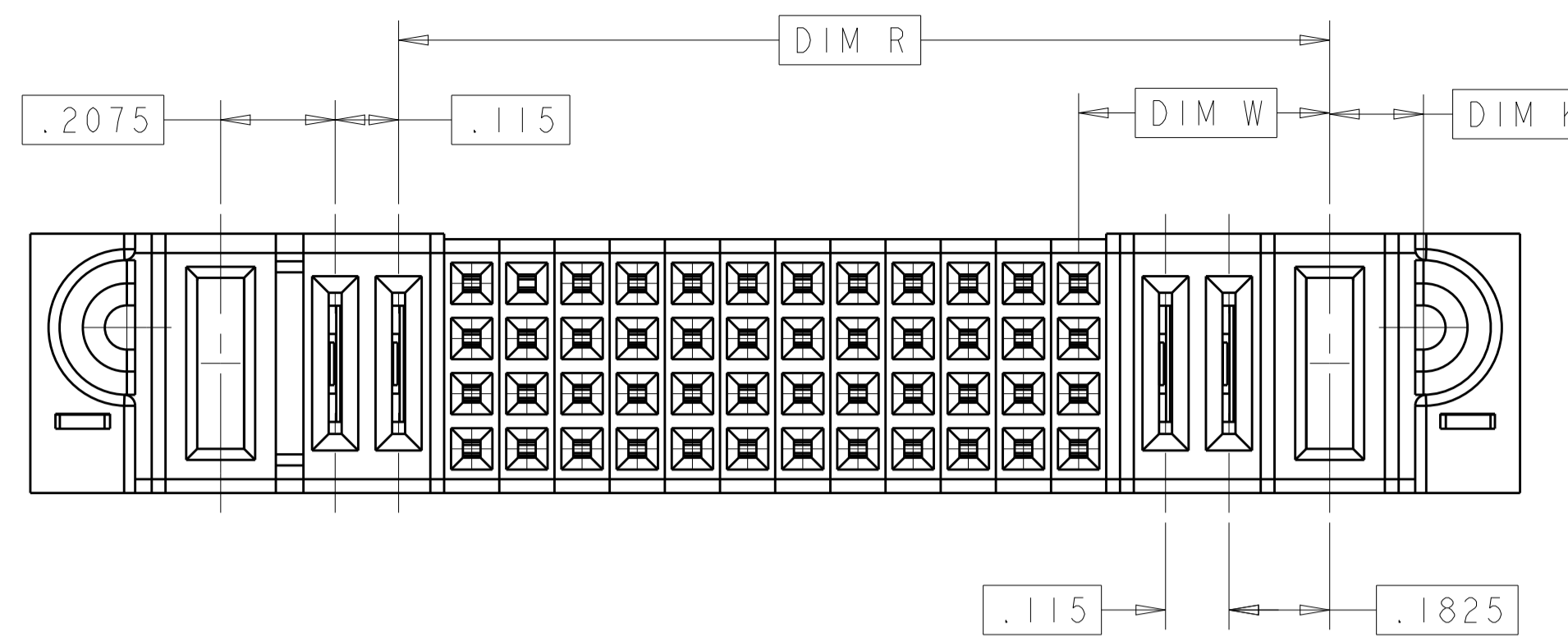

P/N: 6450860-9 CONFIGURATION
 UNSPECIFIED DIMENSION REFER TO SHEET 1

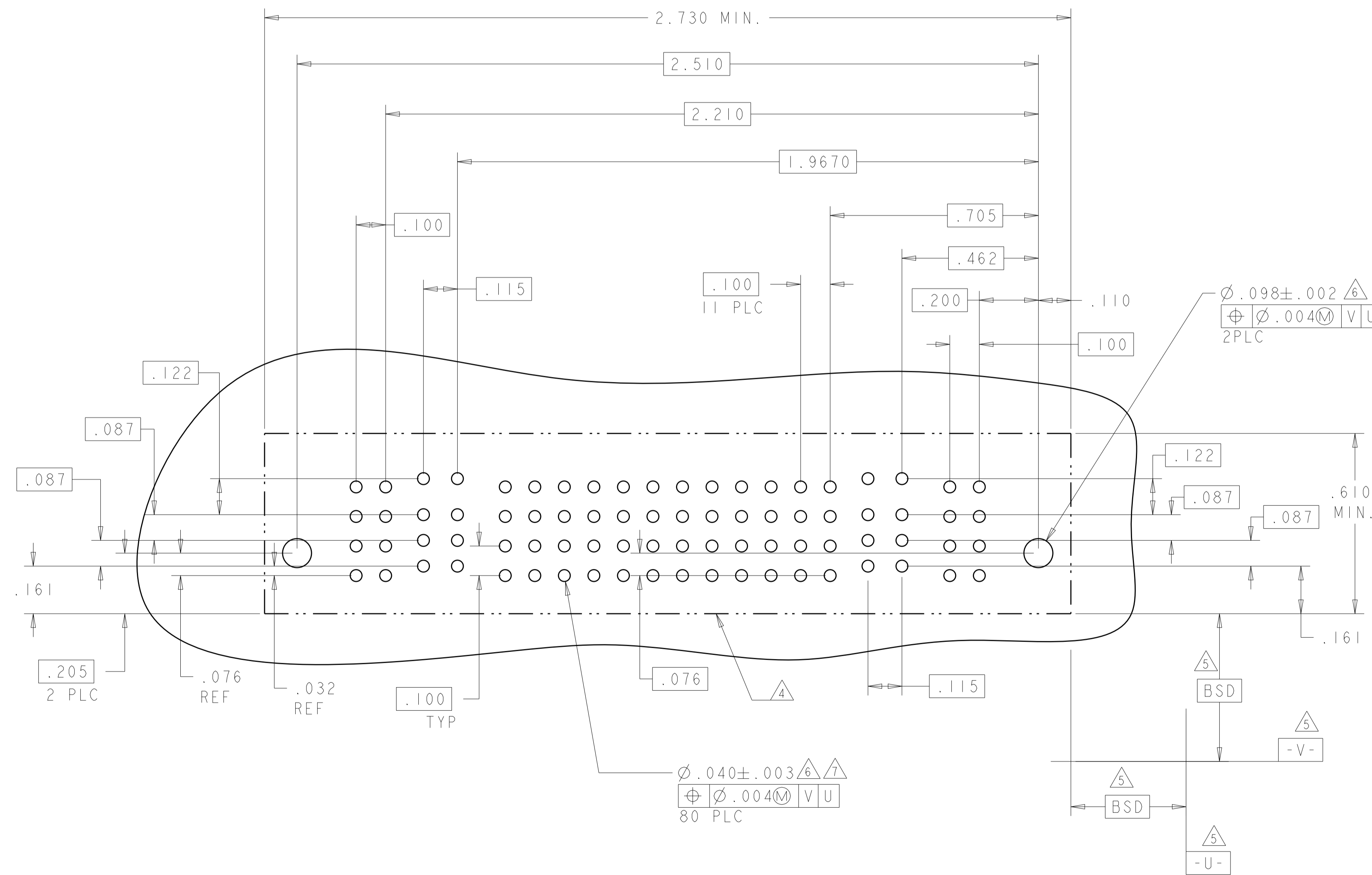

THIS DRAWING IS A CONTROLLED DOCUMENT.		OWN: D. ZHU CHK: S. ZHAO APPV: S. ZHAO	20DEC2007 20DEC2007	TE Connectivity VER RECEP ASSEMBLY SHORT GUIDES, PRESS FIT MULTI-BEAM XLE
DIMENSIONS: INCHES	TOLERANCES UNLESS OTHERWISE SPECIFIED:	PRODUCT SPEC: 108-2292 APPLICATION SPEC: 114-13251 WEIGHT: - CUSTOMER DRAWING		
0 PLC ± 1 PLC ±.01 2 PLC ±.01 3 PLC ±.005 4 PLC ±.0020 ANGLES ±.2°	0 PLC ± 1 PLC ±.01 2 PLC ±.01 3 PLC ±.005 4 PLC ±.0020 ANGLES ±.2°	SIZE: A1 CAGE CODE: 100779 DRAWING NO: 6450860 SCALE: N/A SHEET: 9 of 28 REV: K2		

LOC	DIST	REVISIONS			
		REV	DATE	BY	APPV
ES	00	-	-	-	-
		SEE SHEET 1			

PART NUMBER	ROWS	POWER			SIGNAL							POWER			
		P7	P6	P5	7	6	5	4	3	2	1	P4	P3	P2	P1
1-6450860-0	D	GS	GS	GS		AP	AP	AP	AP	AP		GS	GS	GS	GS
	C					AP	AP	AP	AP	AP					
	B					AP	AP	AP	AP	AP					
	A					AP	AP	AP	AP	AP					
		4P + 28S + 3ACP													

NO CONTACTS LOADED



THIS DRAWING IS A CONTROLLED DOCUMENT.		DWN: D.ZHU	Z0DEC2007		TE Connectivity
DIMENSIONS: INCHES		CHK: S.ZHAO	Z0DEC2007		VER RECEP ASSEMBLY SHORT GUIDES, PRESS FIT MULTI-BEAM XLE
TOLERANCES UNLESS OTHERWISE SPECIFIED:		APV: S.ZHAO	-	NAME	
0 PLC ±		PRODUCT SPEC		SIZE CAGE CODE DRAWING NO RESTRICTED TO	
1 PLC ±.01		108-2292		A100779C=6450860	
2 PLC ±.01		APPLICATION SPEC		SCALE N/A SHEET 10 OF 28 REV K2	
3 PLC ±.005		114-13251			
4 PLC ±.0020		WEIGHT			
ANGLES ±.2°		CUSTOMER DRAWING			
FINISH					

LOC		DIST		REVISIONS				
ES	00	P	LTN	DESCRIPTION	DATE	OWN	APVD	
		-		SEE SHEET 1				

PART NUMBER	ROWS	POWER						SIGNAL		POWER					
		P12	P11	P10	P9	P8	P7	2	1	P6	P5	P4	P3	P2	P1
1-6450860-2	D C B A	GS	GS	GS	GS	GS	GS	AP	AP	GS	GS	GS	GS	GS	GS
		HD								HD					
		6P + 8S + 6P													

PART NUMBER	ROWS	POWER				SIGNAL		POWER			
		P8	P7	P6	P5	2	1	P4	P3	P2	P1
1-6450860-3	D C B A	GS	GS	GS	GS	AP	AP	GS	GS	GS	GS
		HD						HD			
		4P + 8S + 4P									

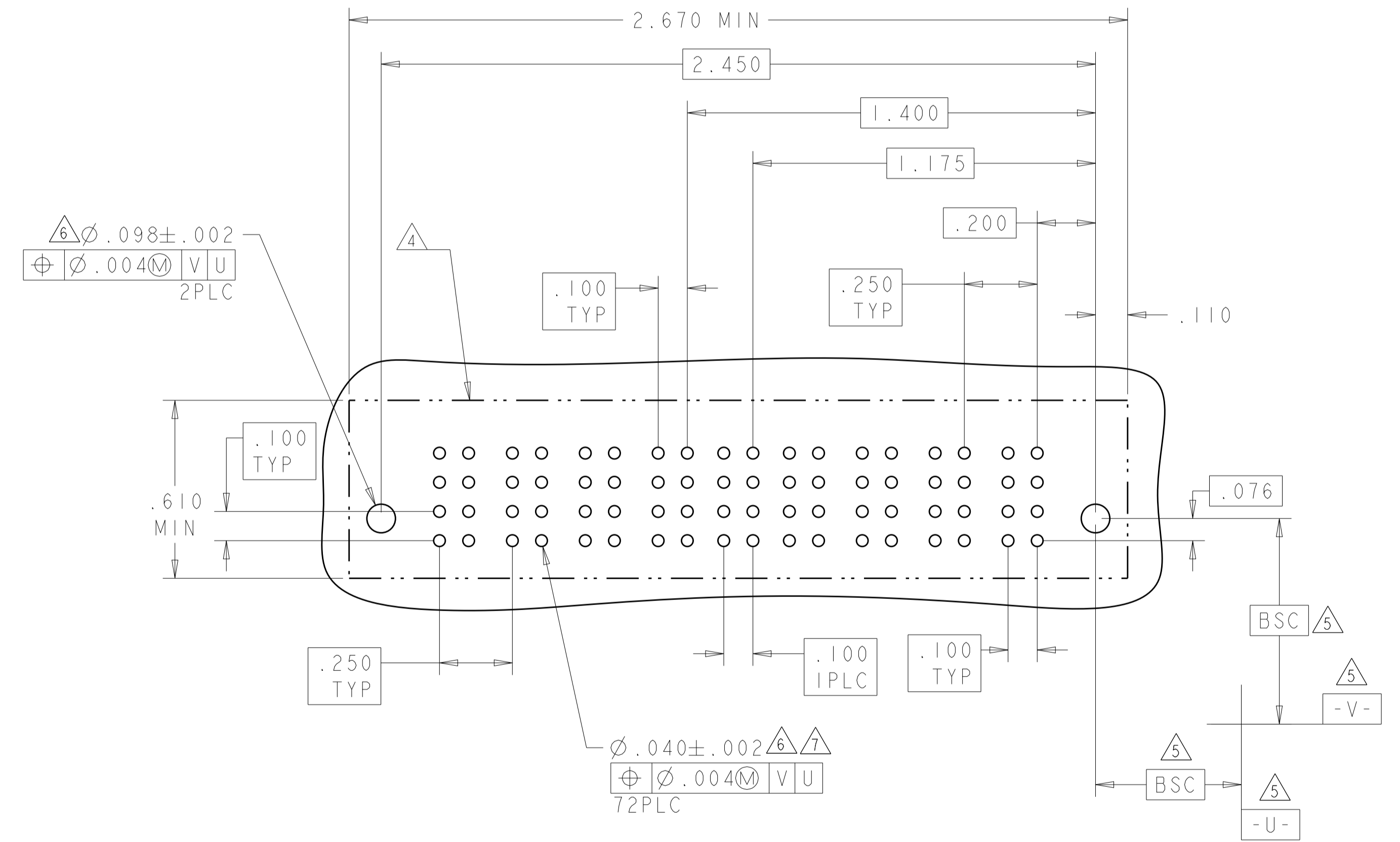

THIS DRAWING IS A CONTROLLED DOCUMENT.		OWN: D. ZHU	20DEC2007	TE Connectivity
DIMENSIONS: INCHES		CHK: S. ZHAO	20DEC2007	
TOLERANCES UNLESS OTHERWISE SPECIFIED:		APVD: S. ZHAO		VER RECEP ASSEMBLY SHORT GUIDES, PRESS FIT MULTI-BEAM XLE
0 PLC ± .01		PRODUCT SPEC	108-2292	
2 PLC ± .01		APPLICATION SPEC	114-13251	
4 PLC ± .002		WEIGHT		
ANGLES ± .020		CUSTOMER DRAWING	SCALE: N/A	SHEET 11 OF 28
MATERIAL: -		A100779C=6450860		REV: K2

LOC	DIST	REVISIONS			
P	LTN	DESCRIPTION	DATE	DMN	APVD
ES	00	SEE SHEET 1			

PART NUMBER	ROWS	POWER				SIGNAL		POWER			
		P8	P7	P6	P5	2	1	P4	P3	P2	P1
1-6450860-4	D C B A	GS	GS	GS	GS	AP	AP	GS	GS	GS	GS
						AP	AP				
						AP	AP				
						AP	AP				
4HDP + 8S + 4HDP											

PART NUMBER	ROWS	POWER				SIGNAL					POWER			
		P8	P7	P6	P5	5	4	3	2	1	P4	P3	P2	P1
1-6450860-5	D C B A	GS	GS	GS	GS	AP	AP	AP	AP	AP	GS	GS	GS	GS
						AP	AP	AP	AP	AP				
						AP	AP	AP	AP	AP				
						AP	AP	AP	AP	AP				
4HDP + 20S + 4HDP														



THIS DRAWING IS A CONTROLLED DOCUMENT.

DIMENSIONS: INCHES	TOLERANCES UNLESS OTHERWISE SPECIFIED: 0 PLC ±. 1 PLC ±.01 2 PLC ±.01 3 PLC ±.005 4 PLC ±.0020 ANGLES ±7°	FINISH	FINISH
-----------------------	---	--------	--------

DMN: D. ZHU	20DEC2007	TE Connectivity
CHK: S. ZHAO	20DEC2007	
APVD: S. ZHAO		NAME: VER RECEP ASSEMBLY SHORT GUIDES, PRESS FIT MULTI-BEAM XLE
PRODUCT SPEC: 108-2292	APPLICATION SPEC: 114-13251	SIZE: A
WEIGHT: -	CAGE CODE: 100779	DRAWING NO: C=6450860
CUSTOMER DRAWING	SCALE: N/A	SHEET 12 OF 28

LOC	DIST	REV	DATE	BY	APP'D
ES	00				

REVISIONS		DATE	BY	APP'D
1	SEE SHEET 1			

PART NUMBER	ROWS	POWER			SIGNAL						POWER						
		P3	P2	P1	6	5	4	3	2	1	LP6	LP5	LP4	LP3	LP2	LP1	
I-6450860-6	D C B A	GS	GS	GS	AP	AP	AP	AP	AP	AP	LSI	LSI	LSI	LSI	LSI	LSI	LSI
					AP	AP	AP	AP	AP	AP							
					AP	AP	AP	AP	AP	AP							
6LP + 24S + 3P																	

PART NUMBER	ROWS	POWER						SIGNAL						POWER					
		P12	P11	P10	P9	P8	P7	6	5	4	3	2	1	P6	P5	P4	P3	P2	P1
I-6450860-7	D C B A	GS	GS	GS	GS	GS	GS	AP	AP	AP	AP	AP	AP	GS	GS	GS	GS	GS	GS
								AP	AP	AP	AP	AP	AP						
								AP	AP	AP	AP	AP	AP						
6HDP + 24S + 6HDP																			

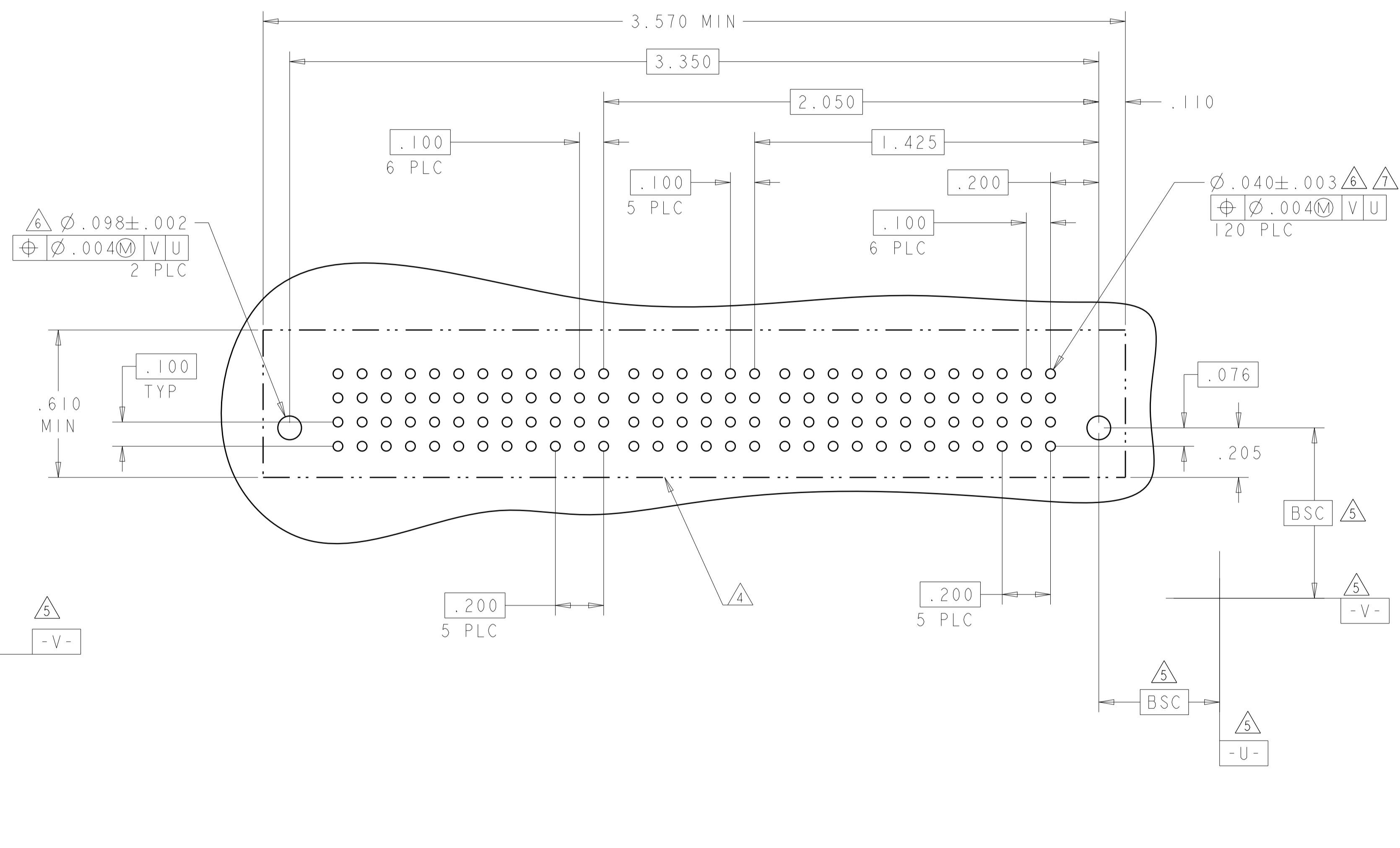

THIS DRAWING IS A CONTROLLED DOCUMENT.		OWN: D. ZHU	20DEC2007	 TE Connectivity
DIMENSIONS: INCHES		CHK: S. ZHAO	20DEC2007	
TOLERANCES UNLESS OTHERWISE SPECIFIED:		APVD: S. ZHAO		VER RECEP ASSEMBLY SHORT GUIDES, PRESS FIT MULTI-BEAM XLE
0 PLC ± .01		PRODUCT SPEC		
1 PLC ± .01		108-2292		SIZE: CAGE CODE: DRAWING NO: RESTRICTED TO A100779 C=6450860
2 PLC ± .01		APPLICATION SPEC		
3 PLC ± .005		114-13251		SCALE: N/A SHEET 13 OF 28 REV: K2
4 PLC ± .0020		WEIGHT		
ANGLES ± .020		CUSTOMER DRAWING		
FINISH				

LOC	DIST	REVISIONS			
P	LTN	DESCRIPTION	DATE	DWN	APVD
-	-	SEE SHEET 1	-	-	-

PART NUMBER	ROWS	POWER		SIGNAL						POWER	
		P4	P3	6	5	4	3	2	1	P2	P1
2-6450860-0	D	GS	GS	AP	AP	AP	AP	AP	AP	GS	GS
	C			AP	AP	AP	AP	AP			
	B			AP	AP	AP	AP	AP			
	A			AP	AP	AP	AP	AP			
2P + 24S + 2P											

PART NUMBER	ROWS	POWER				SIGNAL			POWER			
		P8	P7	P6	P5	3	2	1	P4	P3	P2	P1
2-6450860-8	D	GS	GS	GS	GS	AP	AP	AP	GS	GS	GS	GS
	C					AP	AP	AP				
	B					AP	AP	AP				
	A					AP	AP	AP				
4P + 12S + 4P												

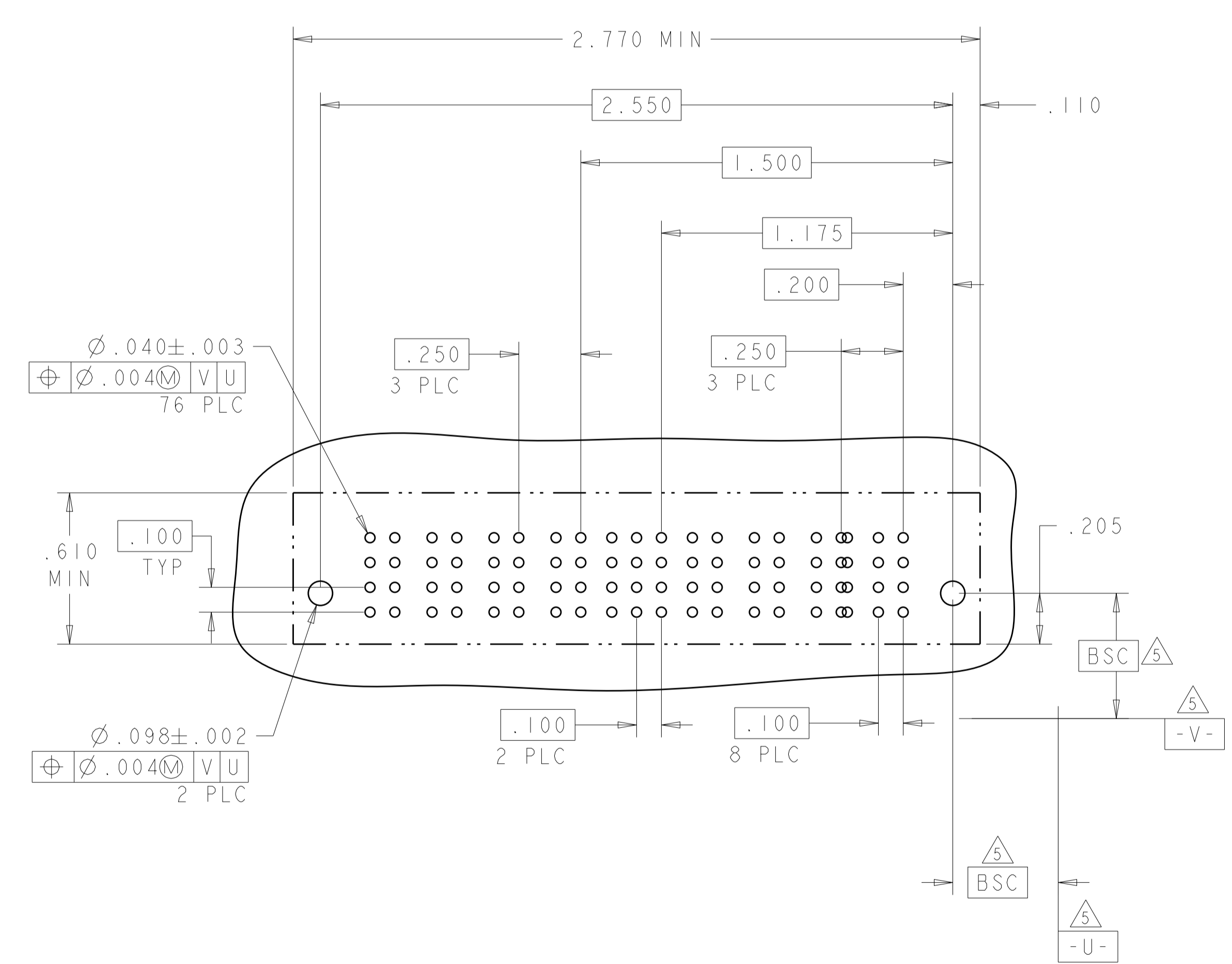
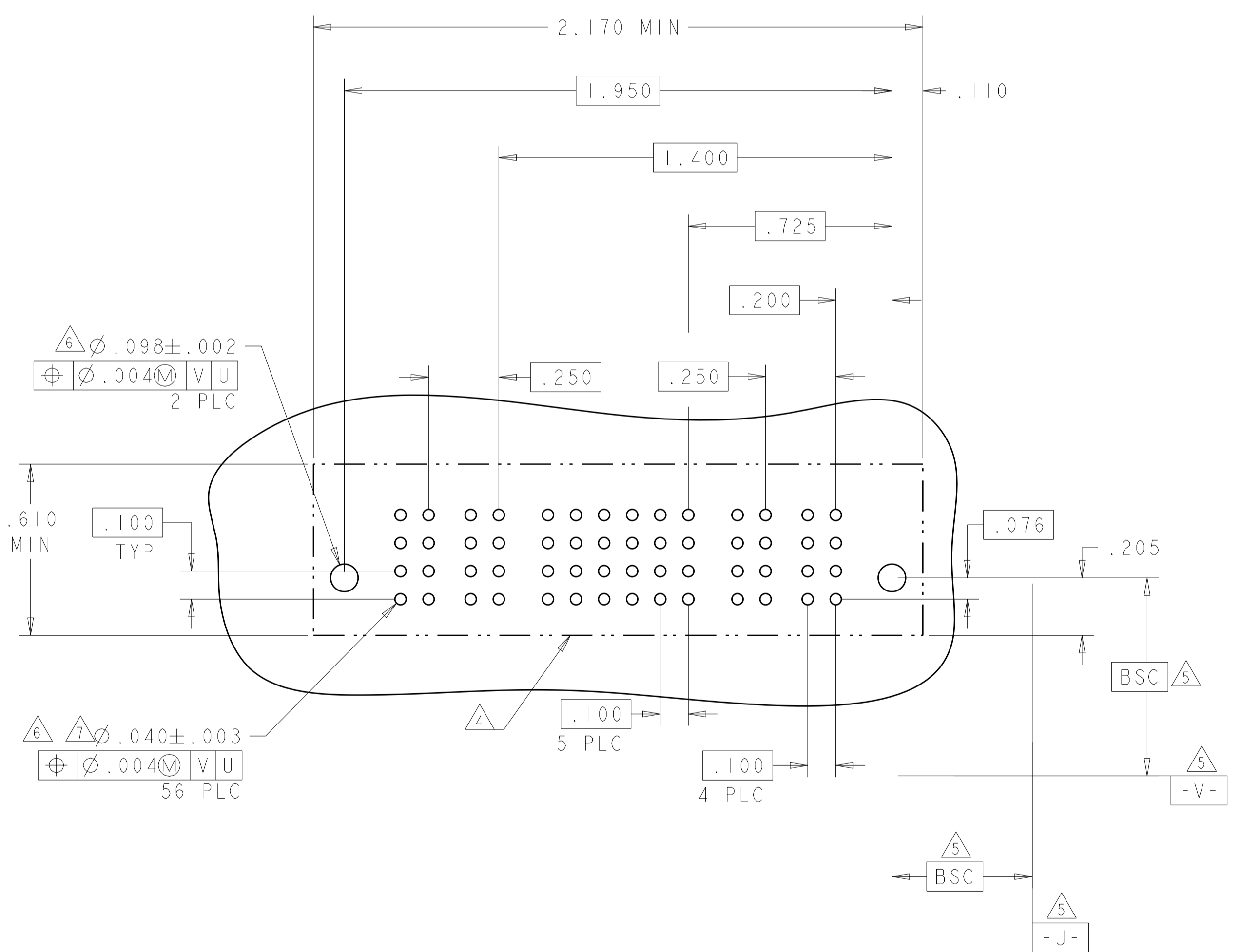

THIS DRAWING IS A CONTROLLED DOCUMENT.

DWN: D. ZHU	20DEC2007	STE TE Connectivity
CHK: S. ZHAO	20DEC2007	
APVD: S. ZHAO		NAME: VER RECEP ASSEMBLY SHORT GUIDES, PRESS FIT MULTI-BEAM XLE
DIMENSIONS: INCHES	TOLERANCES UNLESS OTHERWISE SPECIFIED:	PRODUCT SPEC: 108-2292
0 PLC ± .01	1 PLC ± .01	APPLICATION SPEC: 114-13251
2 PLC ± .01	3 PLC ± .005	SIZE: A100779
4 PLC ± .002	ANGLES ± .2°	CAGE CODE: C=6450860
MATERIAL: -	FINISH: -	WEIGHT: -
CUSTOMER DRAWING		SCALE: N/A
		SHEET 14 OF 28
		REV: K2

LOC	DIST	REVISIONS			
P	LTN	DESCRIPTION	DATE	OWN	APVD
ES	00	SEE SHEET 1			

PART NUMBER	ROWS	POWER		SIGNAL						POWER	
		P4	P3	6	5	4	3	2	1	P2	P1
2-6450860-9	D	GS	GS	AP	AP	AP	AP	AP	AP	GS	GS
	C			AP	AP	AP	AP	AP			
	B			AP	AP	AP	AP	AP			
	A			AP	AP	AP	AP	AP			
2P + 24S + 2P		HD								HD	

PART NUMBER	ROWS	POWER			SIGNAL	POWER	
		P5	P4	P3	1	P2	P1
3-6450860-0	D	LSI	LSI	LSI	AP	LSI	LSI
	C				AP		
	B				AP		
	A				AP		
2LP + 4S + 3LP							



THIS DRAWING IS A CONTROLLED DOCUMENT.

DIMENSIONS: INCHES	TOLERANCES UNLESS OTHERWISE SPECIFIED: 0 PLC ±. 1 PLC ±.01 2 PLC ±.01 3 PLC ±.005 4 PLC ±.002 ANGLES ±.020 FINISH	OWN: D. ZHU CHK: S. ZHAO APVD: S. ZHAO	20DEC2007 20DEC2007	 TE Connectivity	
MATERIAL		NAME: VER RECEPT ASSEMBLY SHORT GUIDES, PRESS FIT MULTI-BEAM XLE	PRODUCT SPEC: 108-2292 APPLICATION SPEC: 114-13251 WEIGHT: -		
CUSTOMER DRAWING		SIZE: A1	CAGE CODE: 100779	DRAWING NO: 6450860	RESTRICTED TO: -
		SCALE: N/A	SHEET: 17	OF: 28	REV: K2

LOC	DIST	REVISIONS					
		P	LTN	DESCRIPTION	DATE	DWN	APVD
ES	00	-	-	SEE SHEET 1	-	-	-

G4

PART NUMBER	ROWS	POWER				SIGNAL																POWER						
		P8	P7	P6	P5	15	14	13	12	11	10	9	8	7	6	5	4	3	2	1	P4	P3	P2	P1				
3-6450860-1	D	LSI	LSI	LSI	LSI	AP	AP	AP	AP	AP	AP	AP	AP	AP	AP	AP	AP	AP	AP	AP	AP	AP	LSI	LSI	LSI	LSI		
	C					AP	AP	AP	AP	AP	AP	AP	AP	AP	AP	AP	AP	AP	AP	AP	AP	AP	AP	LSI	LSI	LSI	LSI	
	B					AP	AP	AP	AP	AP	AP	AP	AP	AP	AP	AP	AP	AP	AP	AP	AP	AP	AP	AP	LSI	LSI	LSI	LSI
	A					AP	AP	AP	AP	AP	AP	AP	AP	AP	AP	AP	AP	AP	AP	AP	AP	AP	AP	AP	LSI	LSI	LSI	LSI
4LP + 60S + 4LP																												



THIS DRAWING IS A CONTROLLED DOCUMENT.		DWN: D. ZHU	Z0DEC2007	TE Connectivity
DIMENSIONS: INCHES		CHK: S. ZHAO	Z0DEC2007	
DIMENSIONS: INCHES TOLERANCES UNLESS OTHERWISE SPECIFIED: 0 PLC ±. 1 PLC ±.01 2 PLC ±.01 3 PLC ±.005 4 PLC ±.0020 ANGLES ±.2°		APVD: S. ZHAO PRODUCT SPEC: 108-2292 APPLICATION SPEC: 114-13251 WEIGHT: -		NAME: VER RECEP ASSEMBLY SHORT GUIDES, PRESS FIT MULTI-BEAM XLE
MATERIAL: -		SIZE: A100779 CAGE CODE: C=6450860 CUSTOMER DRAWING		RESTRICTED TO: - SCALE: N/A SHEET: 18 OF 28 REV: K2

LOC	DIST	REV	DATE	BY	APPV
ES	00				
REVISIONS			DESCRIPTION	DATE	BY
			SEE SHEET 1		



3-6450860-2

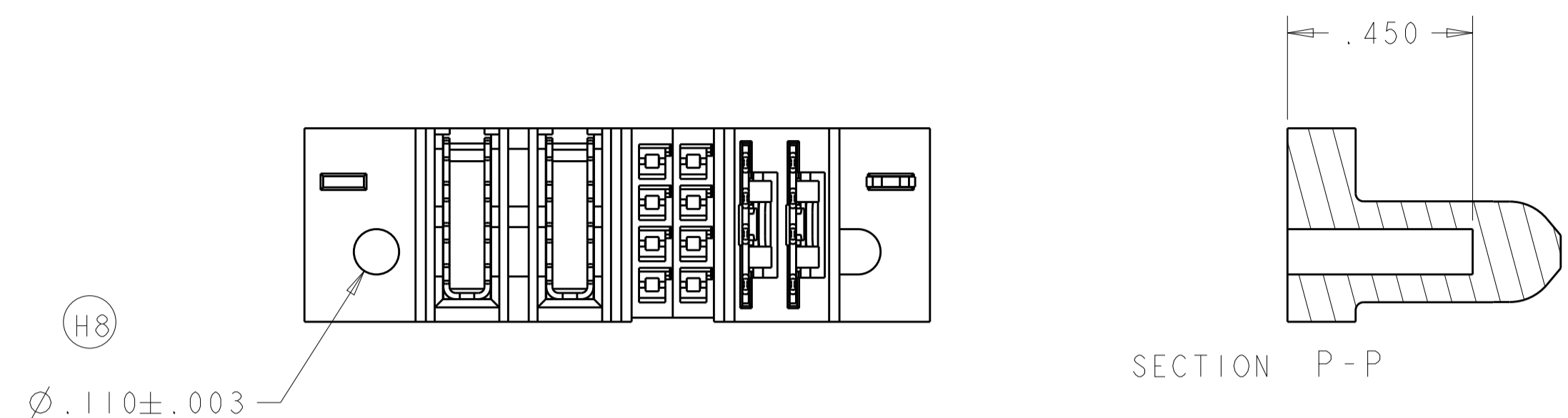

3-6450860-3

PART NUMBER	ROWS	POWER		SIGNAL				POWER	
		P4	P3	3	2	1	2	P2	P1
3-6450860-2	D C B A	GS	GS	AP	AP	AP	AP	GS	GS
		2P + 16S + 2P							

PART NUMBER	ROWS	POWER		SIGNAL		POWER	
		P4	P3	2	1	P2	P1
3-6450860-3	D C B A	GS	GS	AP	AP	LSI	LSI
		2LP + 8S + 2P					

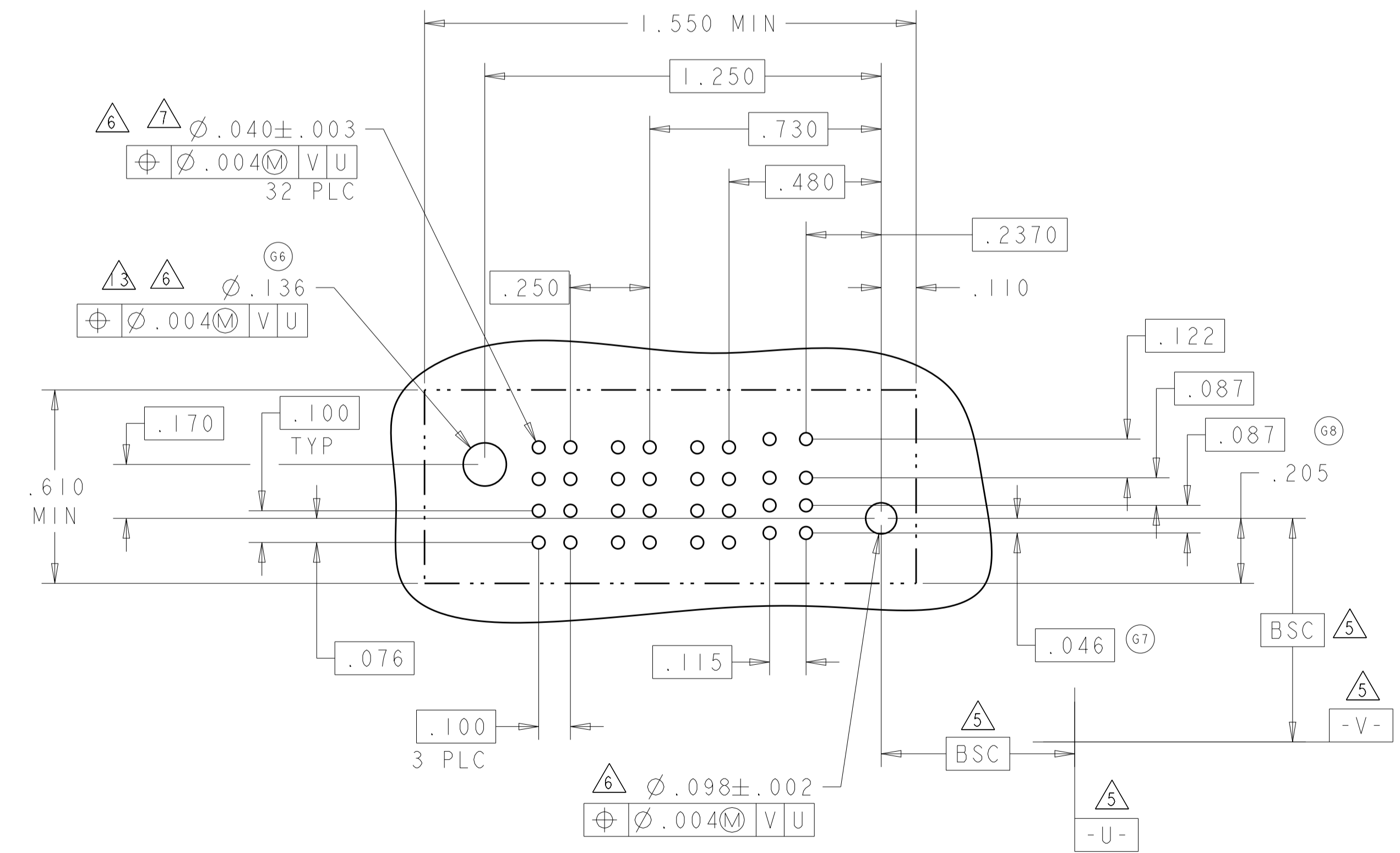
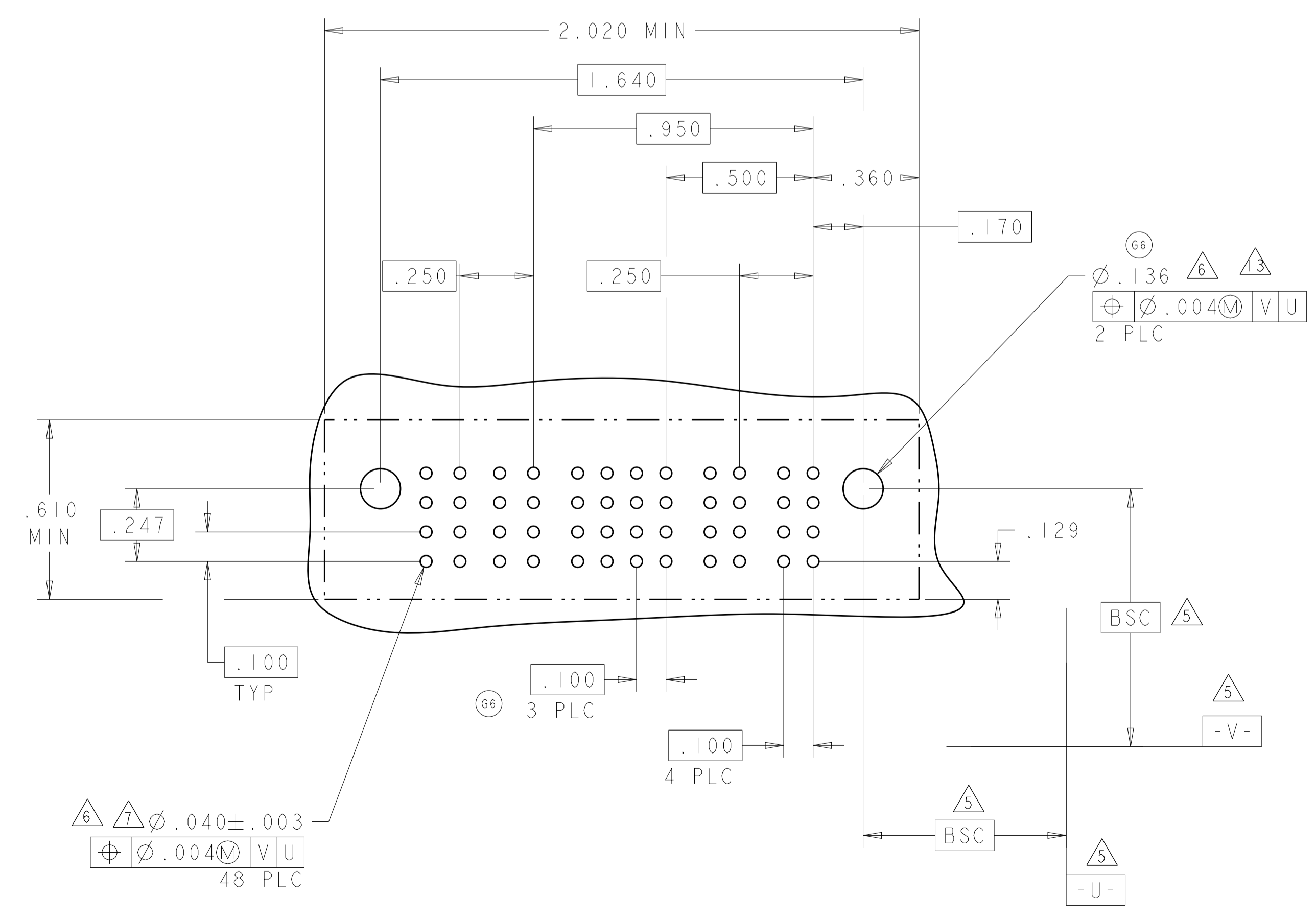

THIS DRAWING IS A CONTROLLED DOCUMENT.

DIMENSIONS:	TOLERANCES UNLESS OTHERWISE SPECIFIED:	DRW: D. ZHU	20DEC2007	STE TE Connectivity
INCHES	0 PLC ± .01 1 PLC ± .01 2 PLC ± .01 3 PLC ± .005 4 PLC ± .002 ANGLES ± .020	CHK: S. ZHAO	20DEC2007	
MATERIAL:	FINISH:	APVD: S. ZHAO	NAME: VER RECP ASSEMBLY	RESTRICTED TO
		PRODUCT SPEC: 108-2292	SHORT GUIDES, PRESS FIT	
		APPLICATION SPEC: 114-13251	MULTI-BEAM XLE	
		WEIGHT:	SIZE: A1	
		CUSTOMER DRAWING	CAGE CODE: 100779	
			DRAWING NO: 6450860	
			SCALE: N/A	
			SHEET: 19	
			OF: 28	
			REV: K2	

LOC	DIST	REVISIONS			
P	LTN	DESCRIPTION	DATE	DMN	APVD
ES	00	SEE SHEET 1	-	-	-

PART NUMBER	ROWS	POWER						SIGNAL						POWER					
		P12	P11	P10	P9	P8	P7	6	5	4	3	2	1	P6	P5	P4	P3	P2	P1
3-6450860-5	D	GS	GS	GS	GS	GS	GS	AP	AP	AP	AP	AP	AP	GS	GS	GS	GS	GS	GS
	AP							AP	AP	AP	AP	AP							
	AP							AP	AP	AP	AP	AP							
	AP							AP	AP	AP	AP	AP							
A	HD																		
6P + 24S + 6P																			

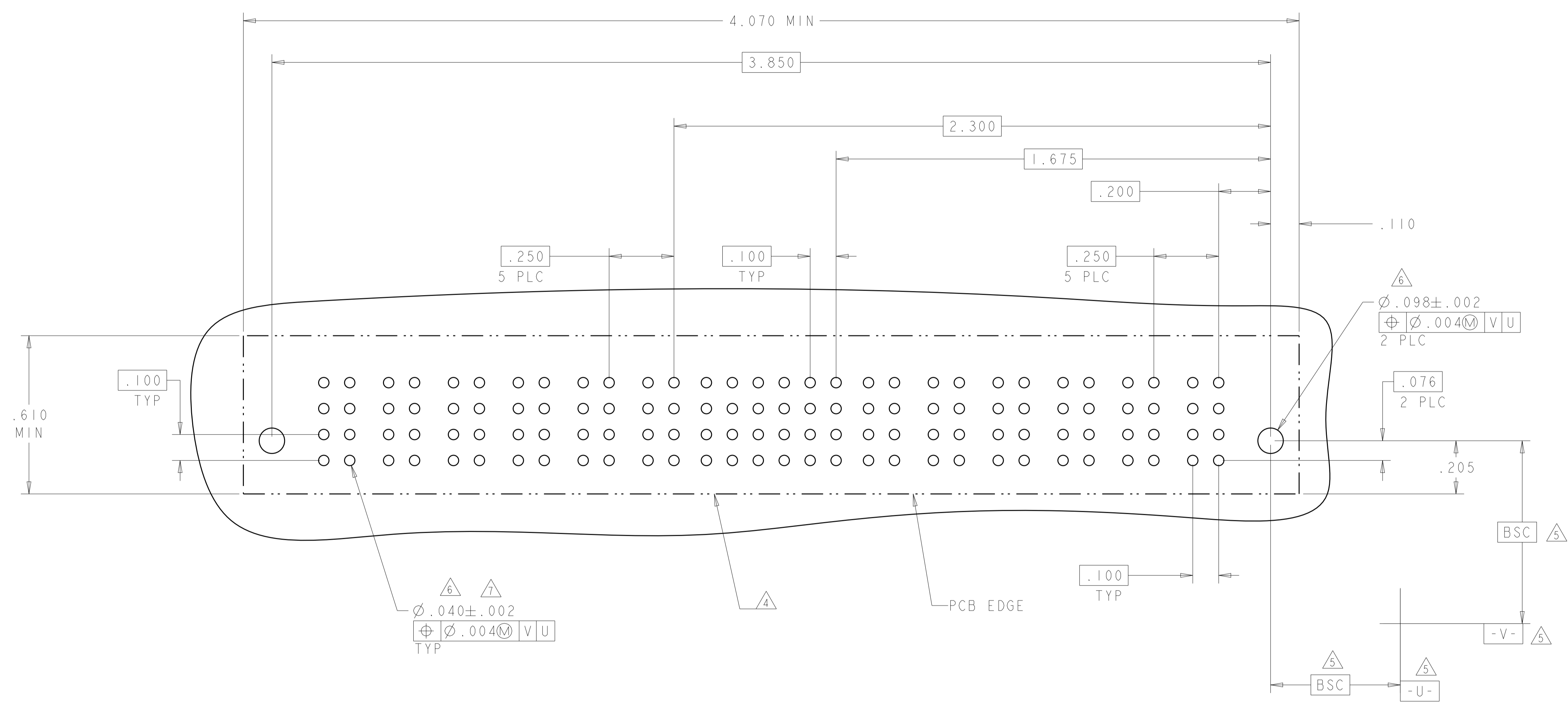

THIS DRAWING IS A CONTROLLED DOCUMENT.		DMN D. ZHU	Z0DEC2007	STE TE Connectivity
DIMENSIONS: INCHES		CHK S. ZHAO	Z0DEC2007	
TOLERANCES UNLESS OTHERWISE SPECIFIED:		APVD S. ZHAO	NAME	VER RECEP ASSEMBLY SHORT GUIDES, PRESS FIT MULTI-BEAM XLE
0 PLC ±		PRODUCT SPEC	108-2292	
1 PLC ±.01		APPLICATION SPEC	114-13251	SIZE CAGE CODE DRAWING NO
2 PLC ±.05		WEIGHT	-	A100779C=6450860
3 PLC ±.0020		FINISH	-	SCALE N/A SHEET 20 OF 28 REV K2
4 PLC ±.0020		CUSTOMER DRAWING	-	
ANGLES ±.75°				

LOC	DIST	REV	DATE	BY	APPV
ES	00				

REVISIONS		DATE	BY	APPV
1	SEE SHEET 1			

PART NUMBER	ROWS	POWER			SIGNAL		POWER	
		P5	P4	P3	2	1	P2	P1
3-6450860-4	D	LSI	LSI	LSI	AP	AP	LSI	LSI
	C				AP	AP		
	B				AP	AP		
	A				AP	AP		

2LP + 8S + 3LP

G3

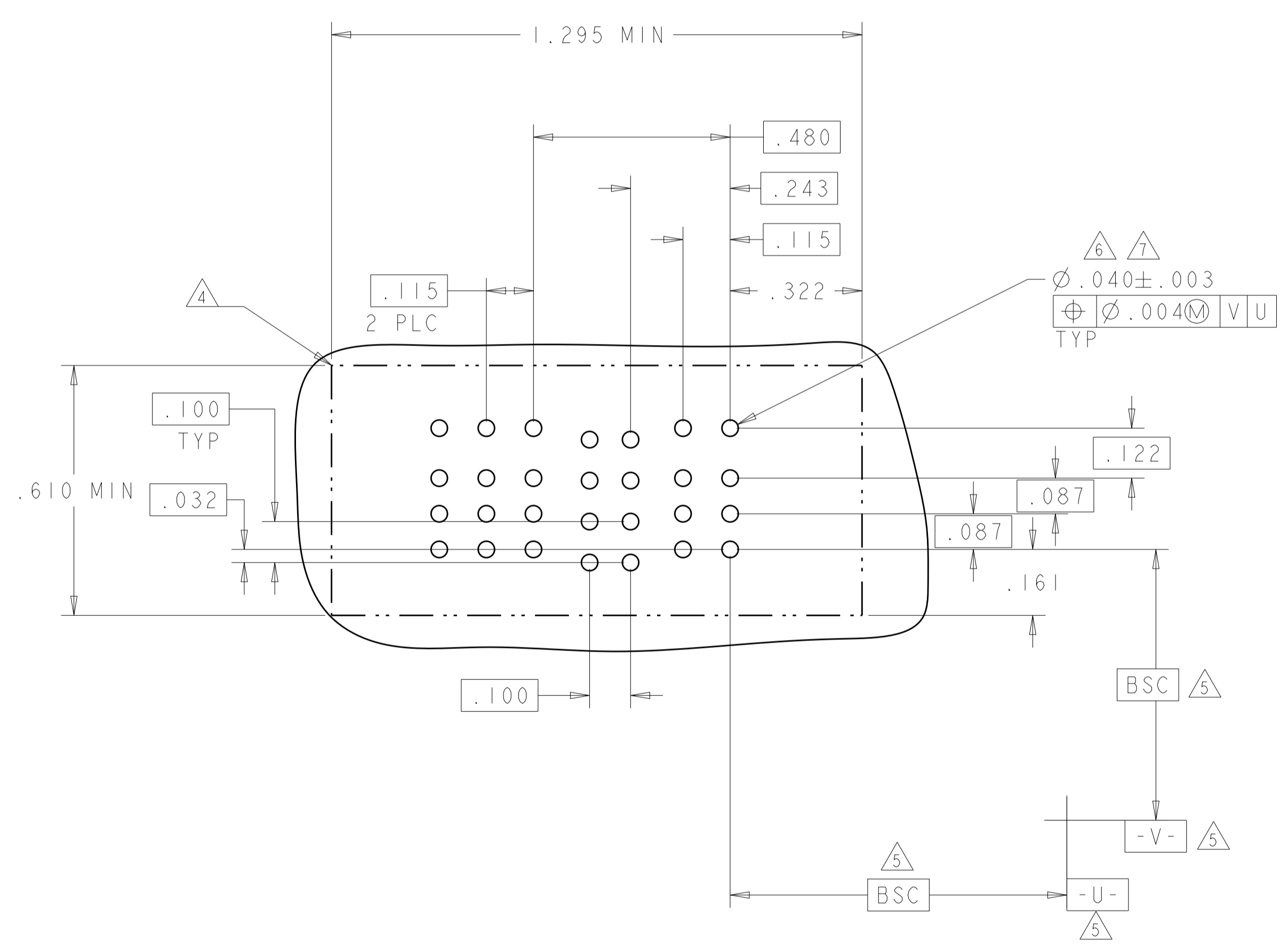

PART NUMBER	ROWS	POWER		SIGNAL												POWER		
		P4	P3	12	11	10	9	8	7	6	5	4	3	2	1	P2	P1	
3-6450860-6	D	GS	GS	AP	AP	AP	AP	AP	AP	AP	AP	AP	AP	AP	AP	AP	AP	AP
	C			AP	AP	AP	AP	AP	AP	AP	AP	AP	AP	AP	AP	AP	AP	AP
	A			AP	AP	AP	AP	AP	AP	AP	AP	AP	AP	AP	AP	AP	AP	AP

2P + 48S + 2P



THIS DRAWING IS A CONTROLLED DOCUMENT.		OWN: D. ZHU	20DEC2007	 TE Connectivity
DIMENSIONS: INCHES		CHK: S. ZHAO	20DEC2007	
TOLERANCES UNLESS OTHERWISE SPECIFIED:		APV: S. ZHAO		NAME: VER RECEP ASSEMBLY SHORT GUIDES, PRESS FIT MULTI-BEAM XLE
0 PLC ± 1 PLC ±.01 2 PLC ±.01 3 PLC ±.005 4 PLC ±.0020 ANGLES ±.7°		PRODUCT SPEC: 108-2292	APPLICATION SPEC: 114-13251	SIZE: A1
MATERIAL: -		FINISH: -	WEIGHT: -	CAGE CODE: 6450860
CUSTOMER DRAWING		SCALE: N/A		SHEET 21 OF 28

LOC		DIST		REVISIONS			
ES	00	P	LTN	DESCRIPTION	DATE	DMN	APVD
		-		SEE SHEET 1			

PART NUMBER	ROWS		POWER			SIGNAL				POWER					
			PI	3	2	1	LP4	LP3	LP2	LP1					
3-6450860-9	D C B A	GS	AP	AP	AP										
			AP	AP	AP										
			AP	AP	AP										
			AP	AP	AP										
4LP + 12S + IP															

PART NUMBER	ROWS		POWER		SIGNAL						POWER			
			P2	P1	6	5	4	3	2	1	PI			
4-6450860-0	D C B A	GS	AP	AP	AP	AP	AP	AP	AP	AP	AP	AP	AP	AP
			AP	AP	AP	AP	AP	AP	AP	AP	AP	AP	AP	AP
			AP	AP	AP	AP	AP	AP	AP	AP	AP	AP	AP	AP
			AP	AP	AP	AP	AP	AP	AP	AP	AP	AP	AP	AP
IP + 24S + IP														

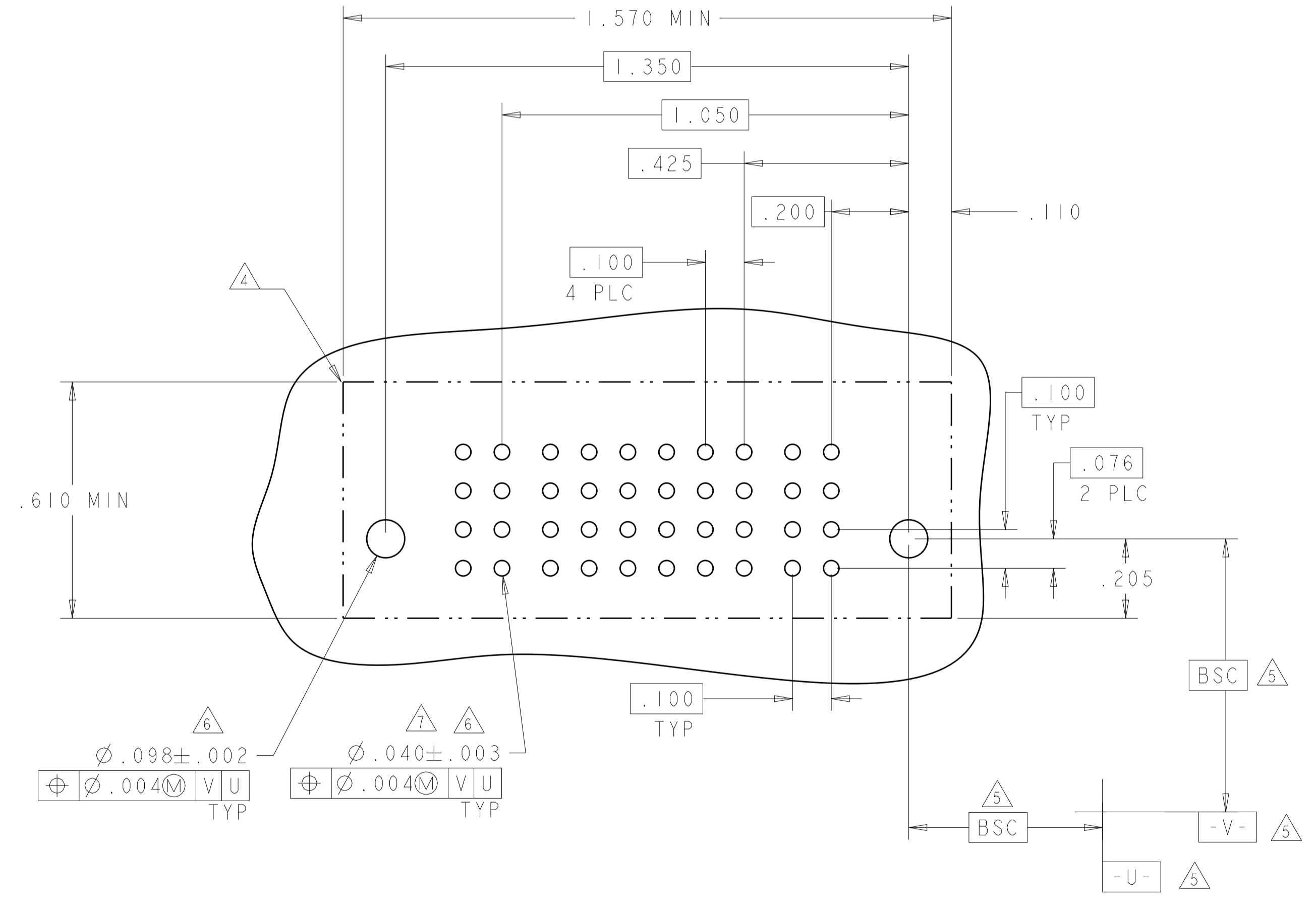

THIS DRAWING IS A CONTROLLED DOCUMENT.

DIMENSIONS:	TOLERANCES UNLESS OTHERWISE SPECIFIED:	DMN: D. ZHU	20DEC2007	 TE Connectivity
INCHES	0 PLC ±.01	CHK: S. ZHAO	20DEC2007	
	1 PLC ±.01	APVD: S. ZHAO		NAME: VER RECEPT ASSEMBLY SHORT GUIDES, PRESS FIT MULTI-BEAM XLE
	2 PLC ±.01	PRODUCT SPEC	108-2292	
MATERIAL:	3 PLC ±.005	APPL SPEC	114-13251	SIZE: CAGE CODE DRAWING NO
FINISH:	4 PLC ±.0020	WEIGHT		A100779C=6450860
	ANGLES ±.020	CUSTOMER DRAWING	SCALE: N/A	SHEET 22 OF 28
				REV: K2

LOC	DIST	REVISIONS			
P	LTN	DESCRIPTION	DATE	DWN	APVD
ES	00	SEE SHEET 1			



4-6450860-2

PART NUMBER	ROWS	POWER		SIGNAL		POWER	
		P4	P3	2	1	P2	P1
4-6450860-2	D C B A	GS	GP	AP	AP	LSI	LSI
				AP	AP		
				AP	AP		
				AP	AP		
							HD
2LP + 8S + 2P							



RECOMMENDED PCB LAYOUT

THIS DRAWING IS A CONTROLLED DOCUMENT.		DWN D. ZHU	20DEC2007	TE Connectivity
DIMENSIONS: INCHES		CHK S. ZHAO	20DEC2007	
DIMENSIONS: INCHES TOLERANCES UNLESS OTHERWISE SPECIFIED: 0 PLC ± 1 PLC ±.01 2 PLC ±.01 3 PLC ±.005 4 PLC ±.0020 ANGLES ±.2°		APVD S. ZHAO		NAME VER RECEP ASSEMBLY SHORT GUIDES, PRESS FIT MULTI-BEAM XLE
MATERIAL		PRODUCT SPEC 108-2292	APPLICATION SPEC 114-13251	SIZE A100779
		WEIGHT		CAGE CODE C=6450860
		CUSTOMER DRAWING		RESTRICTED TO SCALE N/A SHEET 24 OF 28 REV K2

LOC	DIST	REV	DATE	BY	APPV
ES	00				

REVISIONS					
REV	DATE	DESCRIPTION	BY	APPV	DATE
-	-	SEE SHEET 1	-	-	-

PART NUMBER	ROWS	POWER								SIGNAL		POWER							
		P16	P15	P14	P13	P12	P11	P10	P9	2	1	P8	P7	P6	P5	P4	P3	P2	P1
4-6450860-4	D C B A	GS	GS	GS	GS	GS	GS	GS	GS	GS	GS	GS	GS	GS	GS	GS	GS	GS	GS
8P + 8S + 8P																			

J2

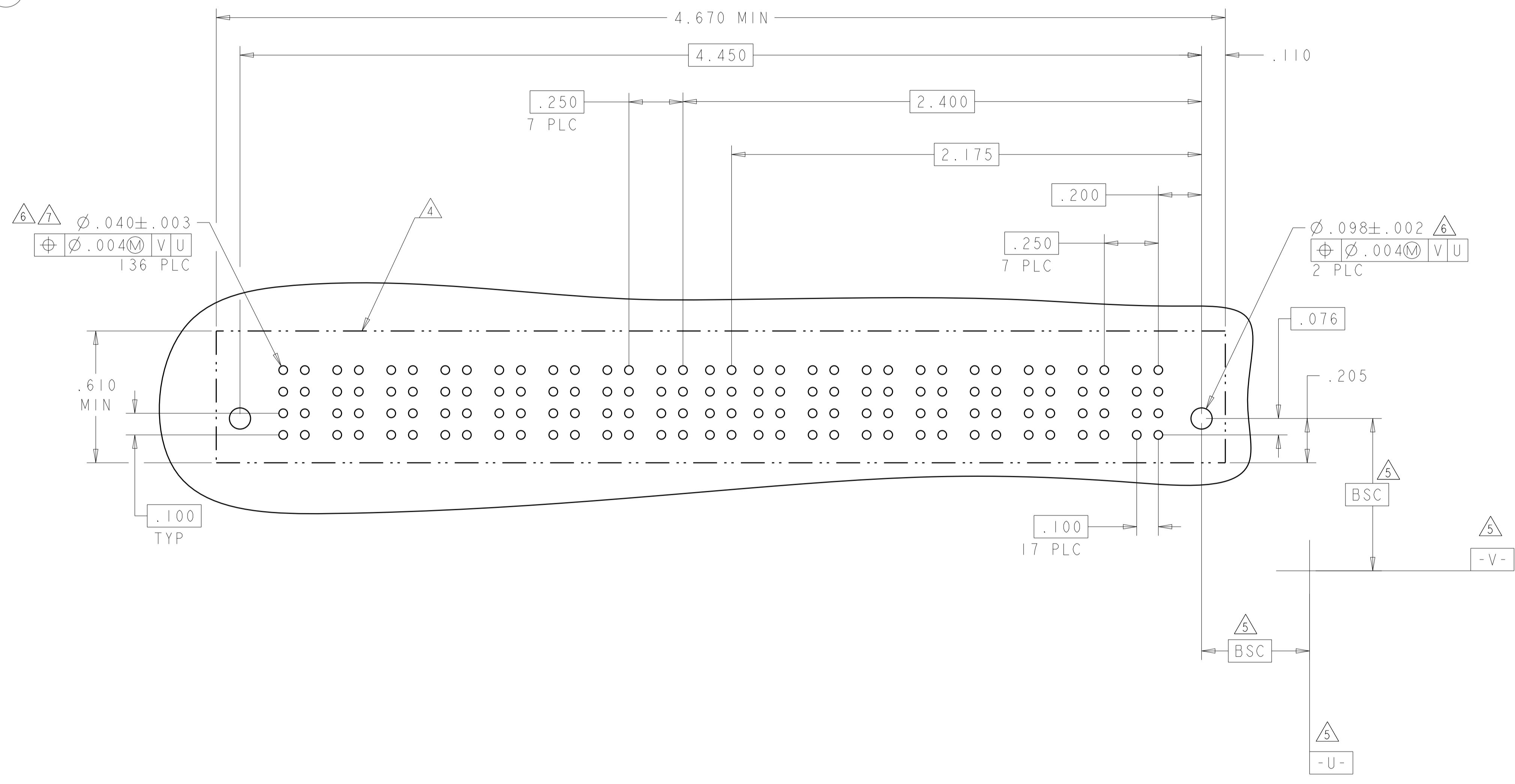

THIS DRAWING IS A CONTROLLED DOCUMENT.		OWN: D. ZHU	20DEC2007	TE Connectivity
DIMENSIONS: INCHES		CHK: S. ZHAO	20DEC2007	
TOLERANCES UNLESS OTHERWISE SPECIFIED:		APVD: S. ZHAO		VER RECEP ASSEMBLY SHORT GUIDES, PRESS FIT MULTI-BEAM XLE
0 PLC ±		PRODUCT SPEC		
1 PLC ±.01		APPLICATION SPEC	108-2292	
2 PLC ±.005		APPLIC. SPEC	114-13251	
3 PLC ±.0020		WEIGHT		SIZE: A100779C=6450860 SCALE: N/A SHEET 25 OF 28 REV: K2
4 PLC ±.0020		CUSTOMER DRAWING		
ANGLES ±.2°				

LOC		DIST		REVISIONS			
ES	00	P	LTN	DESCRIPTION	DATE	DMN	APVD
		-		SEE SHEET 1			

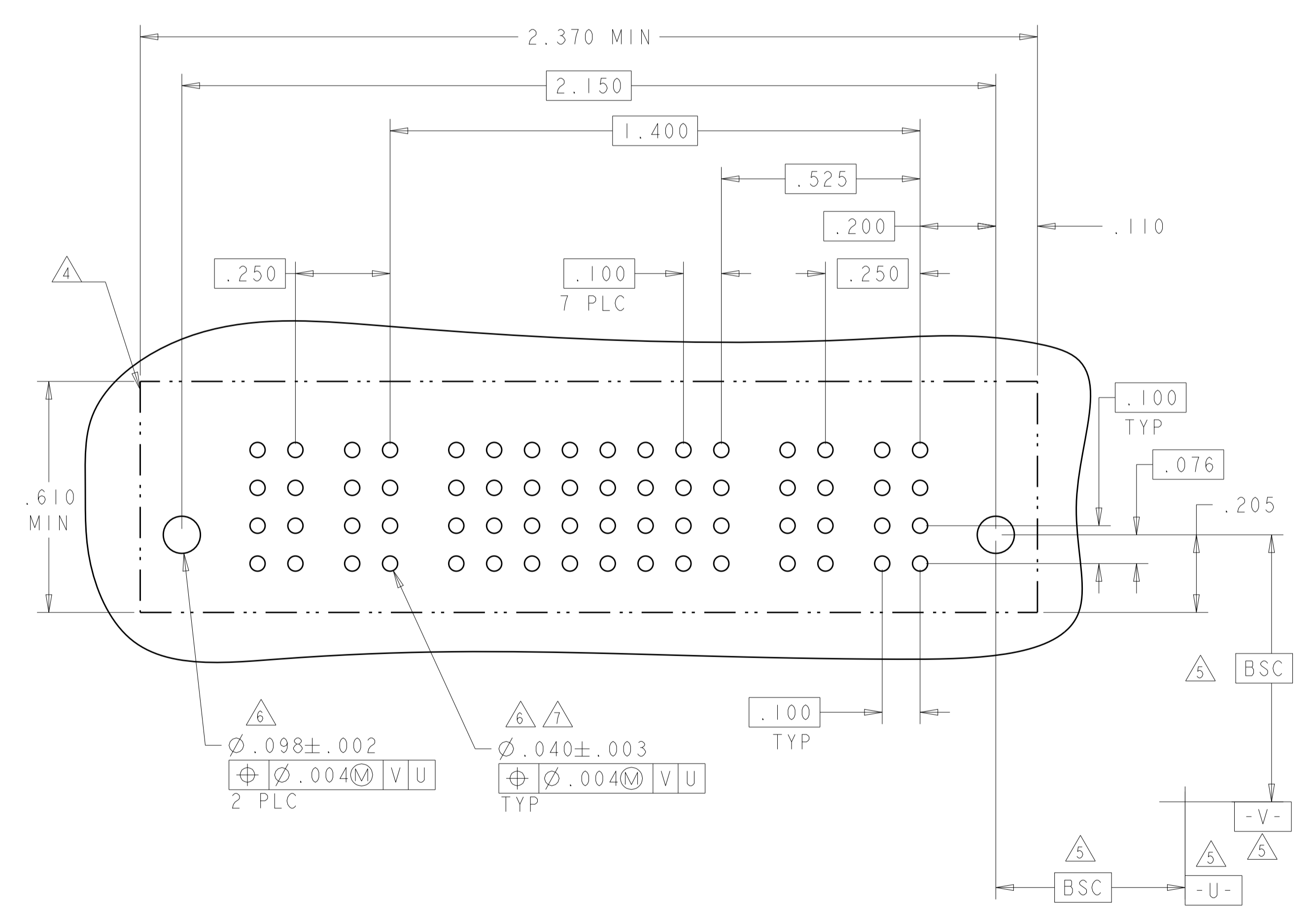
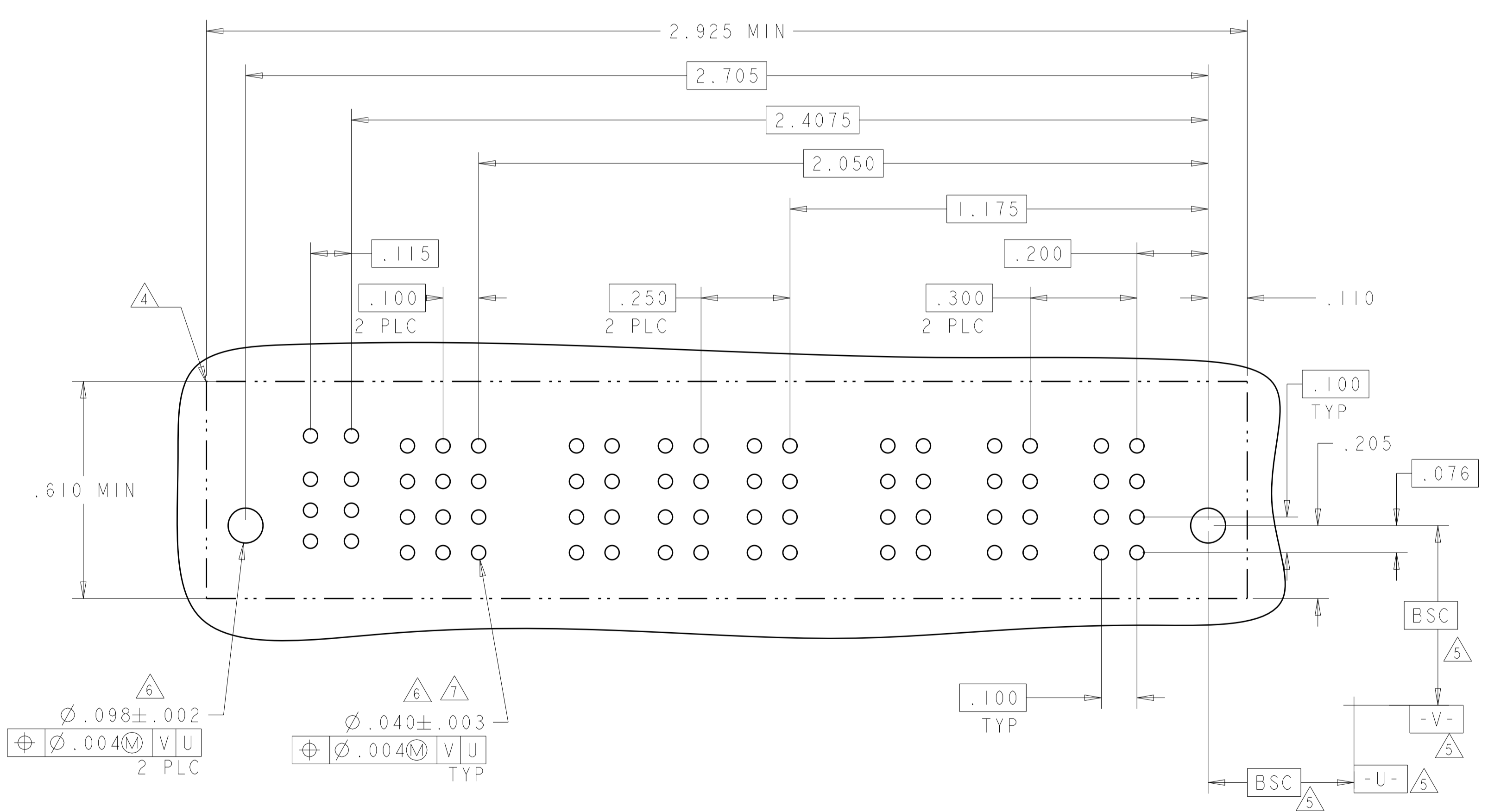

THIS DRAWING IS A CONTROLLED DOCUMENT.

DIMENSIONS:	TOLERANCES UNLESS OTHERWISE SPECIFIED:	DMN: D. ZHU	20DEC2007	 TE Connectivity
INCHES	0 PLC ± .01 1 PLC ± .01 2 PLC ± .01 3 PLC ± .005 4 PLC ± .002 ANGLES ± .020	CHK: S. ZHAO	20DEC2007	
MATERIAL:	FINISH:	APVD: S. ZHAO	NAME:	VER RECEPT ASSEMBLY SHORT GUIDES, PRESS FIT MULTI-BEAM XLE
		PRODUCT SPEC: 108-2292	APPLICATION SPEC: 114-13251	SIZE: A1
		WEIGHT:	CAGE CODE: 6450860	RESTRICTED TO:
		CUSTOMER DRAWING		SCALE: N/A SHEET 26 OF 28 REV: K2

LOC	DIST	REVISIONS			
P	LTN	DESCRIPTION	DATE	OWN	APVD
-	-	SEE SHEET 1	-	-	-

PART NUMBER	ROWS	POWER				SIGNAL					POWER					
		P8	P7	P6	P5	6	5	4	3	2	1	P4	P3	P2	P1	
4-6450860-7	D	GS	GS	GS	GS	AP	AP	AP	AP	AP	AP	GS	GS	GS	GS	
	C					AP	AP	AP	AP	AP						
	B					AP	AP	AP	AP	AP						
	A					AP	AP	AP	AP	AP						
4P + 24S + 4P		HD														HD

PART NUMBER	ROWS	LOW POWER		SIGNAL				LOW POWER	
		P4	P3	4	3	2	1	P2	P1
4-6450860-8	D	LS1	LS1	AP	AP	AP	AP	LS1	LS1
	C			AP	AP	AP	AP		
	B			AP	AP	AP	AP		
	A			AP	AP	AP	AP		
2LP + 16S + 2LP									

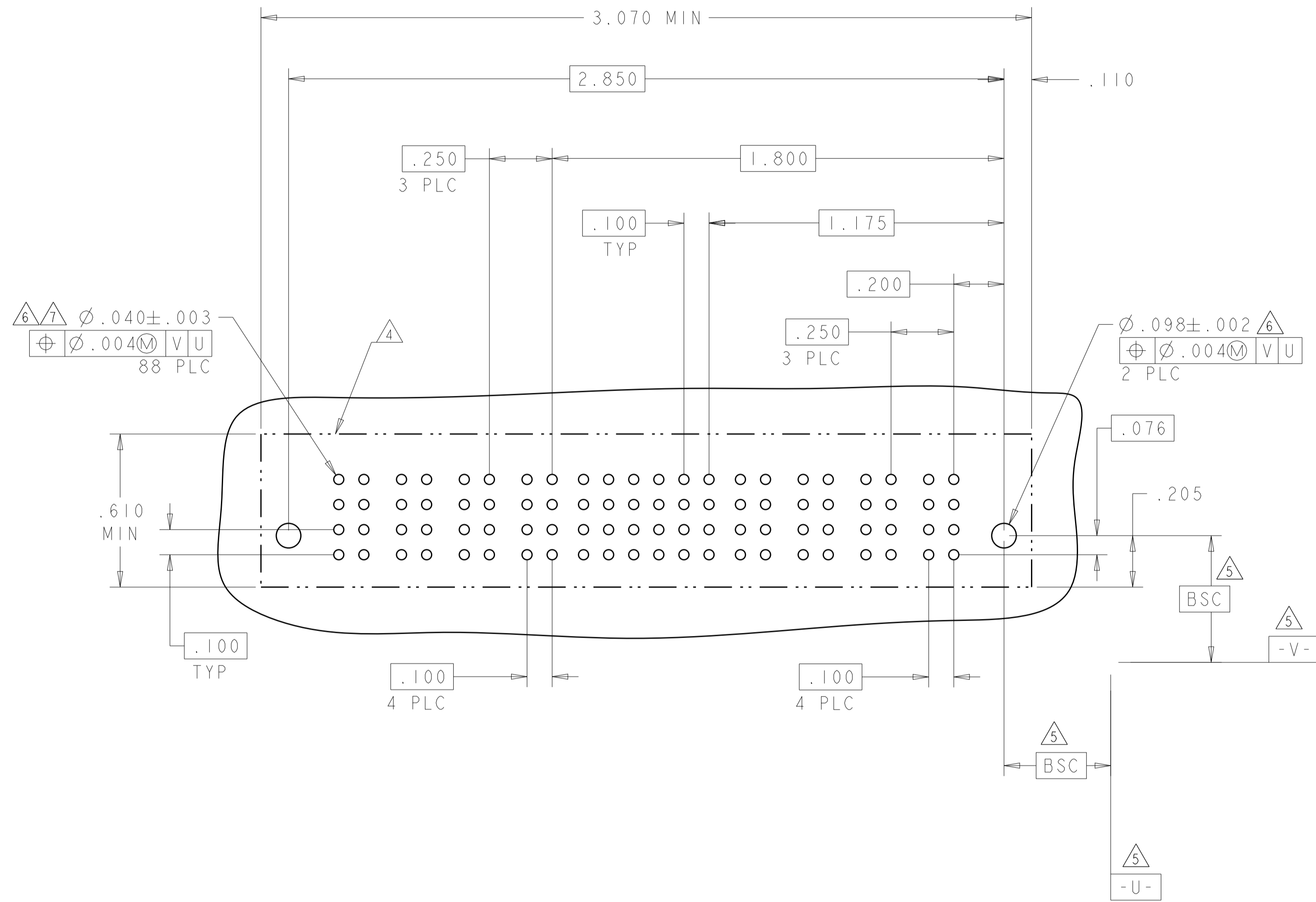

J9

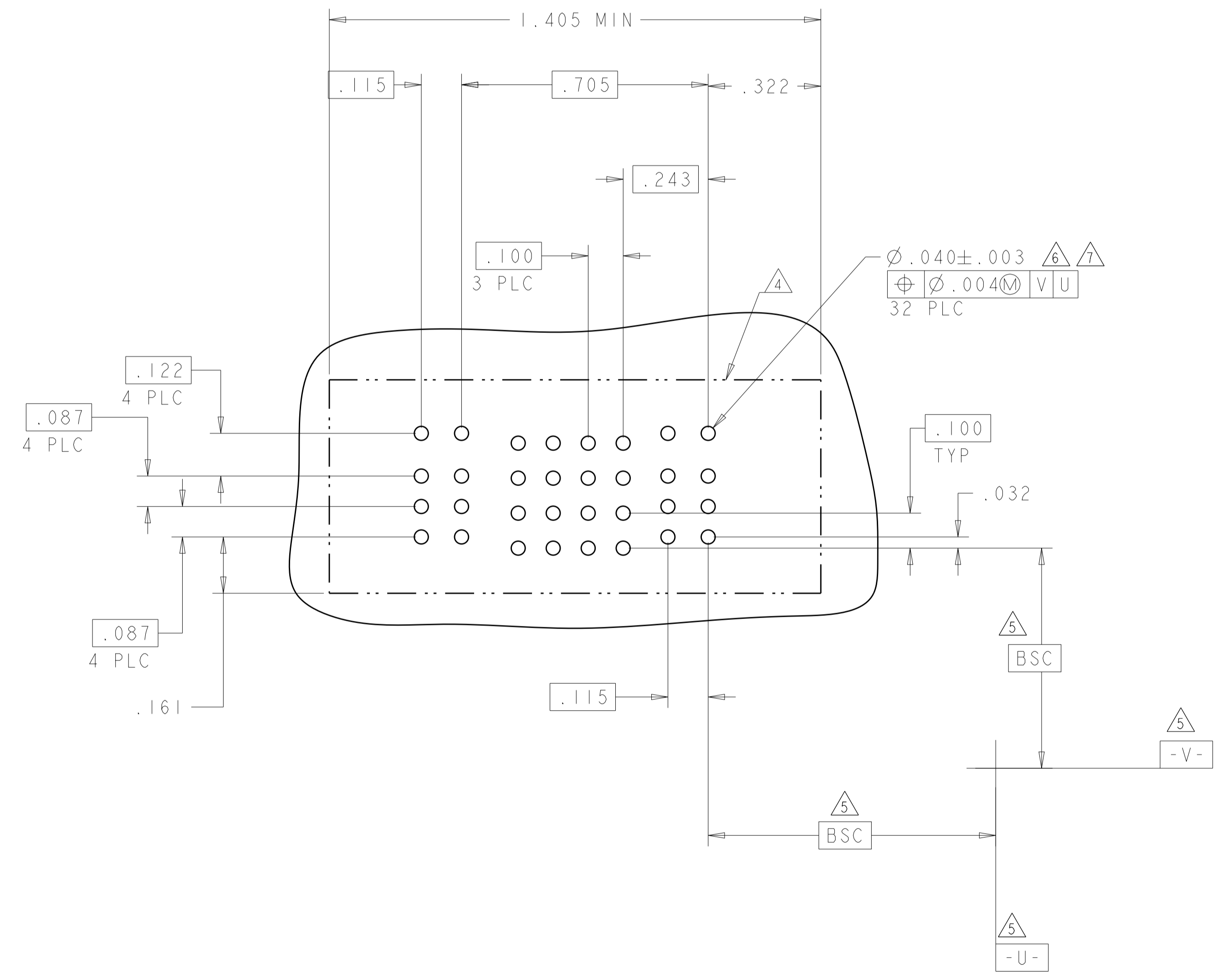

THIS DRAWING IS A CONTROLLED DOCUMENT.		OWN: D. ZHU	20DEC2007	 TE Connectivity
DIMENSIONS: INCHES		CHK: S. ZHAO	20DEC2007	
TOLERANCES UNLESS OTHERWISE SPECIFIED:		APVD: S. ZHAO		NAME: VER RECEPT ASSEMBLY SHORT GUIDES, PRESS FIT MULTI-BEAM XLE
0 PLC ±. 1 PLC ±.01 2 PLC ±.01 3 PLC ±.005 4 PLC ±.0020 ANGLES ±.2° FINISH		PRODUCT SPEC: 108-2292	APPLICATION SPEC: 114-13251	SIZE: A1
MATERIAL: -		WEIGHT: -	CAGE CODE: 6450860	RESTRICTED TO: -
CUSTOMER DRAWING		SCALE: N/A	SHEET: 27 OF 28	REV: K2



Компания «ЭлектроПласт» предлагает заключение долгосрочных отношений при поставках импортных электронных компонентов на взаимовыгодных условиях!

Наши преимущества:

- Оперативные поставки широкого спектра электронных компонентов отечественного и импортного производства напрямую от производителей и с крупнейших мировых складов;
- Поставка более 17-ти миллионов наименований электронных компонентов;
- Поставка сложных, дефицитных, либо снятых с производства позиций;
- Оперативные сроки поставки под заказ (от 5 рабочих дней);
- Экспресс доставка в любую точку России;
- Техническая поддержка проекта, помощь в подборе аналогов, поставка прототипов;
- Система менеджмента качества сертифицирована по Международному стандарту ISO 9001;
- Лицензия ФСБ на осуществление работ с использованием сведений, составляющих государственную тайну;
- Поставка специализированных компонентов (Xilinx, Altera, Analog Devices, Intersil, Interpoint, Microsemi, Aeroflex, Peregrine, Syfer, Eurofarad, Texas Instrument, Miteq, Cobham, E2V, MA-COM, Hittite, Mini-Circuits, General Dynamics и др.);

Помимо этого, одним из направлений компании «ЭлектроПласт» является направление «Источники питания». Мы предлагаем Вам помощь Конструкторского отдела:

- Подбор оптимального решения, техническое обоснование при выборе компонента;
- Подбор аналогов;
- Консультации по применению компонента;
- Поставка образцов и прототипов;
- Техническая поддержка проекта;
- Защита от снятия компонента с производства.



Как с нами связаться

Телефон: 8 (812) 309 58 32 (многоканальный)

Факс: 8 (812) 320-02-42

Электронная почта: org@eplast1.ru

Адрес: 198099, г. Санкт-Петербург, ул. Калинина, дом 2, корпус 4, литера А.