

# Power Line Filters

*Compact design requires minimal real estate and delivers excellent filtering characteristics for both differential and common mode. RoHS compliant, easily installed for a broad array of applications.*



Appliance Filters .....	PF50-PF53
Single Stage.....	PF54-PF69
With Wire Leads .....	PF56-PF57
With Wire Leads for Medical Applications .....	PF58-PF59
Higher Current .....	PF66-PF69
DC – Higher Current .....	PF70-PF71
Dual Stage.....	PF72-PF79

# Power Line Filters Appliance Filters



## 11-MPC Series

### Features

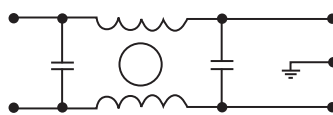
- Miniature general purpose PCB mounted filter
- Requires minimal PCB real estate space
- Low cost
- Operating temperature: -25°C to +70°C
- Two forms of cases are available: metal case and plastic case

### Applications

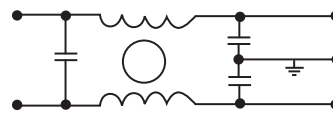
- Personal computers and peripherals
- Digital equipment
- Measuring instruments and medical equipment
- TV & VCR monitors and display units
- Home appliances

### Circuit Diagram

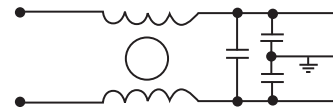
Circuit 1



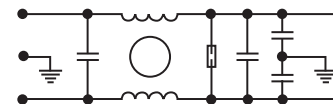
Circuit 2



Circuit 3



Circuit 4



### Specifications

Model	Rated Voltage (@ 50/60Hz)	Rated Current	Leakage Current (Max.)	Circuit Diagram	Figure	Temperature Rise (Max.)
11-MPC-001-2-B	120/250VAC	1A	0.50mA	1	A1	30°C
11-MPC-001-5-A				A		
11-MPC-001-5-B				A1		
11-MPC-002-5-B		2A		D		
11-MPC-002-5-D					E	
11-MPC-003-5-E					A1	
11-MPC-006-5-B		6A		C		
11-MPC-006-5-C						
11-MPC-016-5-B					B	
		16A	0.2mA	4		

Note: Test voltage: 1500VAC one minute, line to ground  
 Insulation resistance: 300 Mohm min. at 500VDC  
 Voltage drop: 1V max. at rated current  
 Weight: 17.5g

# PCB Power Filters Miniature Printed Circuit Board

## 11-MPC Series

**Figure A**



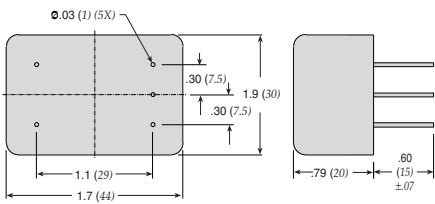
**Figure A1**



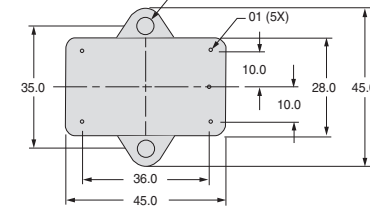
**Figure B**



**Figure C**



**Figure D**



**Figure E**



Dimensions in inches (mm)

### Common Mode



#### 11-MPC-001;-002



#### 11-MPC-003;-006;-016



### Normal Mode



#### 11-MPC-001;-002



#### 11-MPC-003;-006;-016



# Power Line Filters Appliance Filters

## 62-AL/62-AC Series

### Features

- Low-cost plastic case
- Compact design requires minimal real estate space
- Suitable for products that must conform to FCC regulations
- Wide variety of circuit and filtering options
- Good filtering characteristics for both normal mode and common mode
- Epoxy molded for reliability
- Operating temperature: -25°C to +85°C (including temperature rise, see graph on page PF53)

### Applications

- Personal computers and peripherals
- Digital equipment
- Industrial equipment
- Vending machines
- Home appliances
- Office equipment

### Specifications

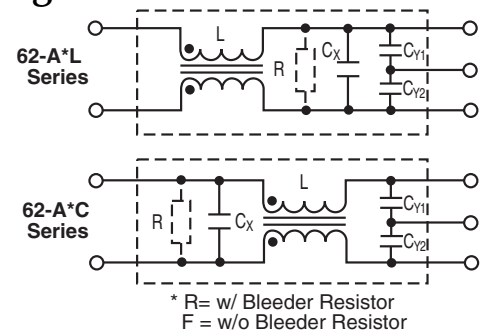
Model*	Rated Voltage (@ 50/60Hz)	Rated Current	Leakage Current (Max.)	Capacitance		Inductance (L <sub>1</sub> )	Temperature Rise (Max.)
				C <sub>Y</sub>	C <sub>X</sub>		
62-AFL-010-3-11	250VAC	1.0A	0.35mA	2200pF	0.1uF	11.0mH	40°C
62-AFC-010-3-11			0.50mA	3300pF			
62-AFL-010-5-11			0.35mA	2200pF			
62-AFC-010-5-11				3300pF			
62-AFL-016-3-11		1.6A	0.35mA	2200pF			
62-AFC-016-3-11				3300pF			
62-AFL-016-5-11		0.50mA	0.35mA	2200pF			
62-AFC-016-5-11				3300pF			
62-AFL-030-3-11		3.0A	0.35mA	2200pF			
62-AFC-030-3-11				0.50mA		3300pF	
62-AFL-030-5-11						2.4mH	
62-AFC-030-5-11				3300pF			
62-AFL-045-3-11		4.5A	0.35mA	2200pF			
62-AFC-045-3-11				0.50mA		3300pF	
62-AFL-045-5-11						1.0mH	
62-AFC-045-5-11				3300pF			
62-AFL-060-3-11		6.0A	0.35mA	2200pF			
62-AFC-060-3-11				0.50mA		3300pF	
62-AFL-060-5-11						0.53mH	
62-AFC-060-5-11				3300pF			

Note: All types are designed to meet the requirement of UL 1283, CSA 22.2. VDE 0565-3  
 Test voltage: 1500VAC one minute, line to ground  
 Insulation resistance: 300 Mohm min. at 500VDC  
 Voltage drop: 1V max.

\* Available with bleeder resistor  
 Replace F with R for part number



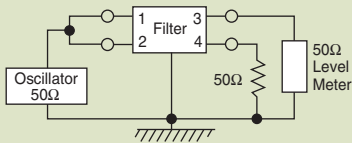
### Circuit Diagrams



# Power Line Filters Appliance Filters

## 62-AL/62-AC Series

### Common Mode



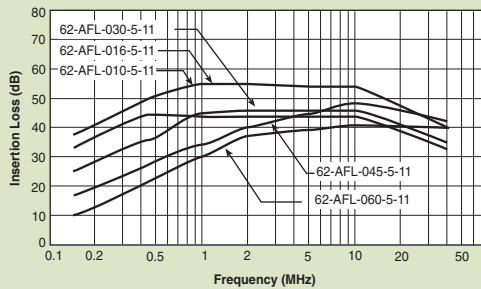
#### 62-AFL-xxx-3-11



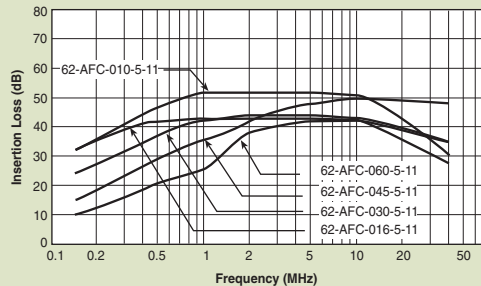
#### 62-AFC-xxx-3-11



#### 62-AFL-xxx-5-11



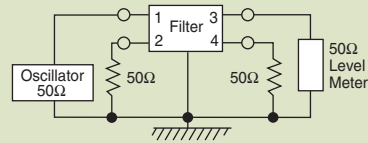
#### 62-AFC-xxx-5-11



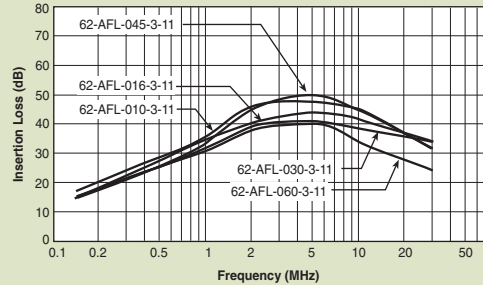
## Temperature Characteristics



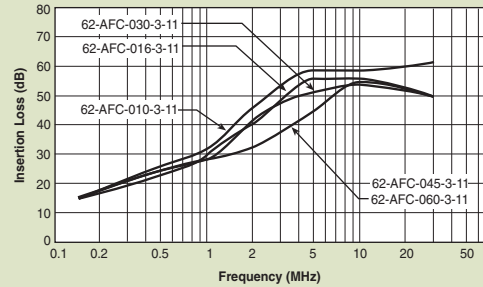
### Normal Mode



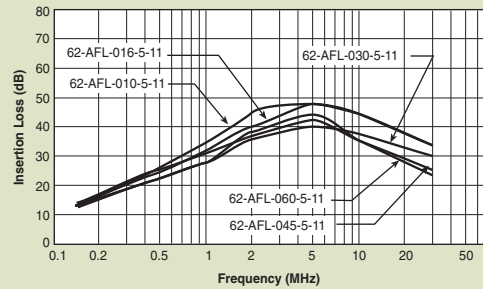
#### 62-AFL-XXX-3-11



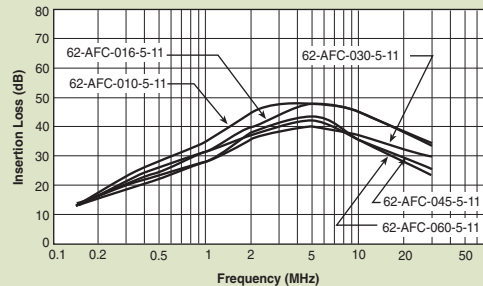
#### 62-AFC-XXX-3-11



#### 62-AFL-xxx-5-11



#### 62-AFC-xxx-5-11



# Power Line Filters Single Stage

## 62-PPF/PQF/PRF Series



Tested and found to be  
IAW VDE 0565 Part 3

### Features

- Low-cost plastic case
- Compact design requires minimal real estate space
- Suitable for products that must conform to FCC and FTZ regulations
- Wide variety of circuit and filtering options
- Good filtering characteristics for both normal mode and common mode
- Epoxy molded for reliability
- Operating temperature: -25°C to +85°C (including temperature rise, see graph on page PF55)

### Applications

- Personal computers and peripherals
- Digital equipment
- Industrial equipment
- Vending machines
- Office equipment



### Circuit Diagrams



\* Bleeder Resistor is available only for  
62-P(Q/R/P)F-XXX-X-12

### Specifications

Model	Rated Voltage (@ 50/60Hz)	Rated Current	Leakage Current (Max.)	Capacitance		Inductance (L <sub>1</sub> )	Temperature Rise (Max.)		
				C <sub>Y</sub>	C <sub>X</sub>				
62-PQF-020-5-11	250VAC	2A	0.50mA	3300pF	0.1uF	15mH	30°C		
62-PQF-020-5-12					.22uF				
62-PPF-020-5-11					0.1uF				
62-PPF-020-5-12					.22uF				
62-PQF-030-5-11					0.1uF			8mH	
62-PQF-030-5-12					.22uF				
62-PPF-030-5-11		0.1uF							
62-PPF-030-5-12		.22uF							
62-PQF-060-5-11		6A			3A	0.1uF		2.1mH	
62-PQF-060-5-12						.22uF			
62-PPF-060-5-11						0.1uF			
62-PPF-060-5-12						.22uF			
62-PRF-010-5-11						0.1uF			486uH
62-PRF-010-5-12						.22uF			
62-PRF-020-5-11		2A			2A	0.1uF		181uH	
62-PRF-020-5-12						.22uF			
62-PRF-030-5-11						0.1uF			97uH
62-PRF-030-5-12						.22uF			

Note: All types are designed to meet the requirement of UL 1283, CSA 22.2, VDE 0565-3

Test voltage: 1500VAC one minute, line to ground

Insulation resistance: 300 Mohm min. at 500VDC

Voltage drop: 1V max. (except 62-PRF-010-5-11) at rated current

62-PRF-010-5-11: 1.5V max. at rated current

Weight: 62-PPF & PQF Series: 2.11 ounces (60 grams)

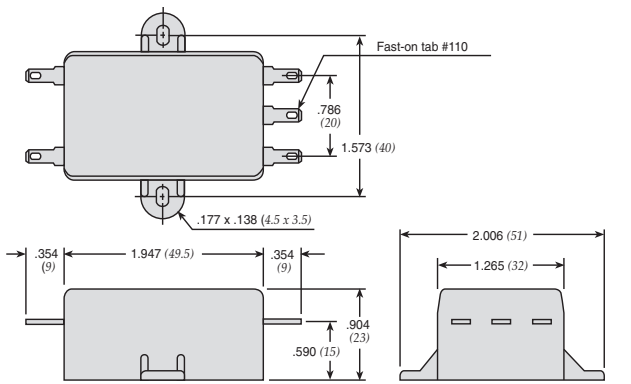
62-PRF Series: 1.76 ounces (50 grams)



# Power Line Filters Single Stage

## 62-PPF/PQF/PRF Series

### Temperature Characteristics



Also available with .250 Fast-ons

Dimensions in inches (mm)

### Normal Mode



#### 62-PQF Series



#### 62-PPF Series



### Common Mode



#### 62-P(Q/R)F Series



#### 62-PRF Series



# Power Line Filters Single Stage Wire Leads



## 62-PML Series



Tested and found to be  
IAW VDE 0565 Part 3

### Features

- Compact design requires minimal real estate space
- Suitable for products that must conform to FCC and FTZ regulations
- Excellent attenuation for high voltage impulse
- Metal case provides effective shielding
- Excellent filtering characteristics for both normal mode and common mode
- Structure provides effective shielding for noise generated externally and internally
- Operating temperature: -25°C to +85°C (including temperature rise, see graph on page PF57)

### Applications

- Digital equipment
- Personal computers and peripherals
- Measuring instruments
- Medical equipment
- Factory automation equipment

### Circuit Diagram



## Specifications

Model	Rated Voltage (@ 50/60Hz)	Rated Current	Leakage Current (Max.)	Capacitance		Inductance (L <sub>1</sub> )	Temperature Rise (Max.)
				C <sub>Y</sub>	C <sub>X</sub>		
62-PML-015-3-11	250VAC	1.5A	0.35mA	2200pF	0.1uF	10.0mH	30°C
62-PML-015-5-11			0.50mA	3300pF		4.3mH	
62-PML-030-3-11		3A	0.35mA	2200pF		2.4mH	
62-PML-030-5-11			0.50mA	3300pF			
62-PML-050-3-11		5A	0.35mA	2200pF			
62-PML-050-5-11			0.50mA	3300pF			

Note: All types are designed to meet the requirement of UL 1283, CSA 22.2. VDE 0565-3

Test voltage: 1500VAC one minute, line to ground

Insulation resistance: 300 Mohm min. at 500VDC

Voltage drop: 1V max. at rated current

Weight: 62-PML-015 Series: 3.06 ounces (87 grams)

62-PML-030 Series: 3.17 ounces (90 grams)

62-PML-050 Series: 3.28 ounces (93 grams)

Discharge time: 0.4 sec. max.



# Power Line Filters Single Stage Wire Leads

## 62-PML Series

### Temperature Characteristics

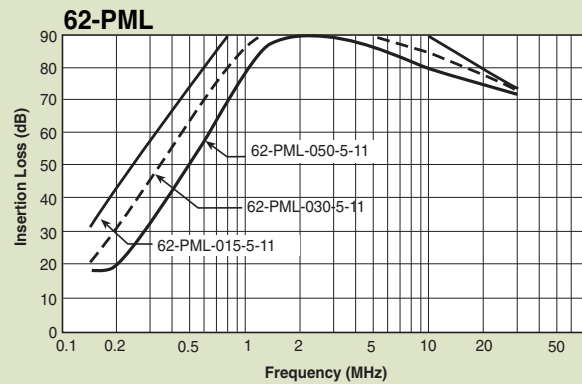


\* Custom lengths available upon request. Dimensions in inches (mm)

### Common Mode



### Normal Mode



# Power Line Filters Single Stage Wire Leads

for Medical Purpose Applications

## 12-PML & 12-PMF Series



### Features

- Compact design requires minimal real estate space
- Suitable for products that must conform to FCC and FTZ regulations
- Excellent attenuation for high voltage impulse
- Metal case provides effective shielding
- Excellent filtering characteristics for both normal mode and common mode
- Structure provides effective shielding for noise generated externally and internally
- Operating temperature: -25°C to +70°C
- Low leakage current

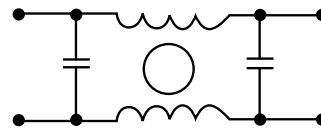
### Applications

- Digital equipment
- Personal computers and peripherals
- Measuring instruments
- Medical equipment
- Factory automation equipment

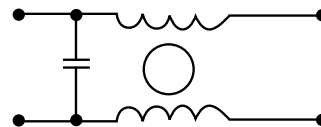


### Circuit Diagram

Circuit 1



Circuit 2



### Specifications

Model	Rated Voltage (@ 50/60Hz)	Rated Current	Leakage Current (Max.)	Circuit Diagram	Figure	Temperature Rise (Max.)
12-PML-001-2-A	120/250VAC	1A	5uA	1	A	30°C
12-PML-002-2-A		2A				
12-PML-006-2-A		6A				
12-PML-010-2-A		10A		2	B	
12-PMF-001-2-B		1A				
12-PMF-002-2-B		2A				
12-PMF-006-2-B		6A		1	C	
12-PML-001-2-C		1A				

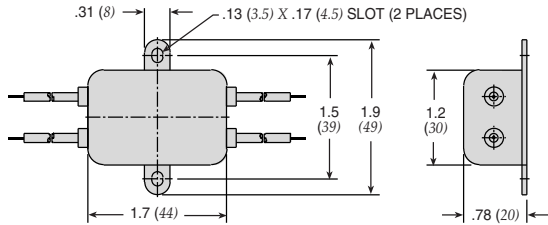
Note: All types are designed to meet the requirement of UL 1283, CSA 22.2. VDE 0565-3  
 Test voltage: 1500VAC one minute, line to ground  
 Insulation resistance: 300 Mohm min. at 500VDC  
 Voltage drop: 1V max. at rated current  
 Discharge time: 0.4 sec. max.

# Power Line Filters Single Stage Wire Leads

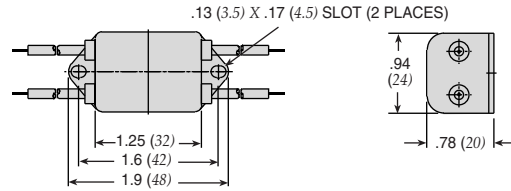
for Medical Purpose Applications

## 12-PML & 12-PMF Series

**Figure A**



**Figure C**



**Figure B**



Dimensions in inches (mm)

### Common Mode



#### 12-PML-001;-002;-006;-010



#### 12-PMF-001;-002;-006;-010



### Normal Mode



#### 12-PML-001;-002;-006;-010



#### 12-PMF-001;-002;-006;-010



# Power Line Filters Single Stage



## 62-LMF & LMB Series



Tested and found to be  
IAW VDE 0565 Part 3

### Features

- Space saving, compact designs
- Suitable for products that must conform to FCC and FTZ regulations
- Excellent filtering characteristics for both normal mode and common mode
- Structure provides effective shielding for noise generated externally and internally
- Metal case provides effective shielding
- Rugged construction
- Operating temperature: -25°C to +85°C (including temperature rise, see graph on page PF61)

### Applications

- Digital equipment
- Office automation equipment, such as copy and fax machines
- Computers and peripherals
- Instrumentation and controls

### Circuit Diagram



## Specifications

Model*	Rated Voltage (@ 50/60Hz)	Rated Current	Leakage Current (Max.)	Capacitance		Inductance (L <sub>1</sub> )	Temperature Rise (Max.)	
				C <sub>Y</sub>	C <sub>X</sub>			
62-LMB-030-5-11	250VAC	3A	0.50mA	3300pF	0.1uF	14mH	45°C	
62-LMF-030-5-11		5A			0.1uF & .22uF	7.0mH		
62-LMB-050-5-11					8A	.22uF		4.2mH
62-LMF-050-5-11		10A				.33uF		2.2mH
62-LMB-080-5-11					.33uF	2.2mH		2.2mH
62-LMF-080-5-11								
62-LMB-100-5-11					.33uF	2.2mH		2.2mH
62-LMF-100-5-11		.33uF						

Note: Test voltage: 1500VAC one minute, line to ground  
Insulation resistance: 300 Mohm min. at 500VDC  
Voltage drop: 1V max. at rated current  
Discharge time: 0.4 sec. max.  
Weight: 5.3 ounces (150 grams)

\*62-LMF - designates Fast-on terminals  
62-LMB - designates Bolt-in terminals  
62-LML - wire lead in/outputs also available

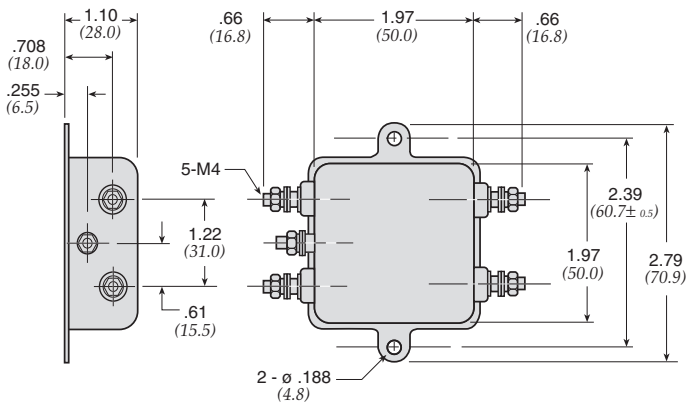
# Power Line Filters Single Stage

## 62-LMF & LMB Series

### Temperature Characteristics



### 62-LMB



### 62-LMF



Dimensions in inches (mm)

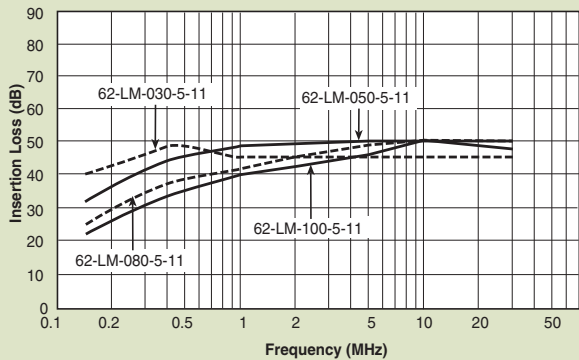
### Common Mode



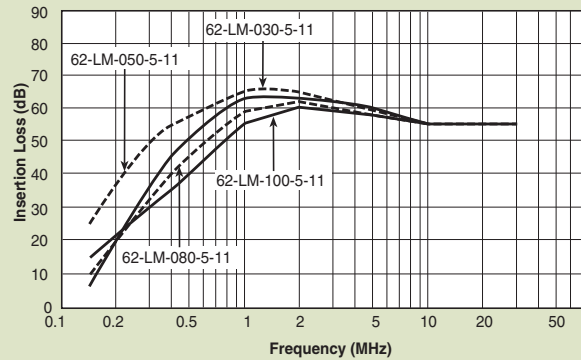
### Normal Mode



### 62-LMF & LMB



### 62-LMF & LMB



# Power Line Filters Single Stage

## 62-PMF & PMB Series



Tested and found to be  
IAW VDE 0565 Part 3

### Features

- Space-saving, compact designs
- Suitable for products that must conform to FCC regulations
- Excellent attenuation for high voltage impulse
- Metal case provides effective EMI shielding
- Excellent filtering characteristics for both normal mode and common mode
- Epoxy molded for internal component reliability
- Structure provides effective shielding for noise generated externally and internally
- Operating temperature: -25°C to +85°C (including temperature rise, see graph on page PF63)

### Applications

- Digital equipment
- Computers and peripherals
- Measuring instruments
- Medical equipment
- Equipment requiring very high impulse attenuation
- Factory automation equipment
- Industrial equipment such as UPS, inverters and converters
- Telecommunications equipment
- Office automation equipment, such as copy and fax machines



### Circuit Diagram



## Specifications

Model*	Rated Voltage (@ 50/60Hz)	Rated Current	Leakage Current (Max.)	Capacitance		Inductance (L <sub>1</sub> )	Temperature Rise (Max.)				
				C <sub>Y</sub>	C <sub>X</sub>						
62-PMB-050-5-11	250VAC	5A	0.50mA	3300pF	0.1uF	14mH	30°C				
62-PMF-050-5-11		8A						.1uF	7.0mH		
62-PMB-080-5-11										10A	.22uF
62-PMF-080-5-11		15A			.33uF	2.2mH		35°C			
62-PMB-100-5-12									20A	1.8mH	45°C**
62-PMF-100-5-12											
62-PMB-150-5-13											
62-PMF-150-5-13											
62-PMB-200-5-13											
62-PMF-200-5-13											

Note: Test voltage: 1500VAC one minute, line to ground  
Insulation resistance: 300 Mohm min. at 500VDC  
Voltage drop: 1V max.  
Discharge time: 0.4 sec. max.  
Weight: 8.82 ounces ( 250 grams)

\* PMF - designates Fast-on terminals

PMB - designates Bolt-in terminals

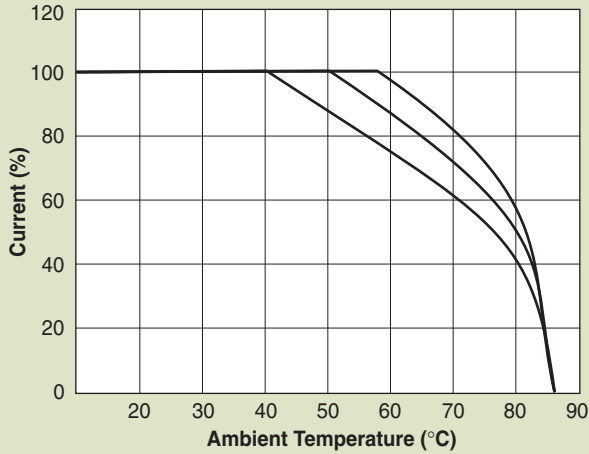
\*\* The temperature rise of 20 amp units can be decreased to 30°C by mounting on 200 X 200 x 1.0(mm) steel chassis



# Power Line Filters Single Stage

## 62-PMF & PMB Series

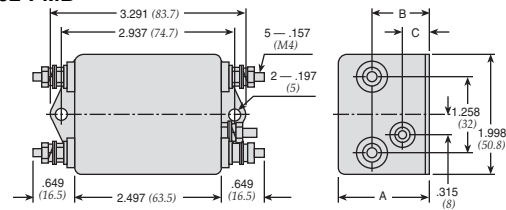
### Temperature Characteristics



### 62-PMF



### 62-PMB



MODEL	A	B	C
62-PMF/PMB-100-200	1.490 (38)	.944 (24)	.433 (11)
62-PMF/PMB-050-080	1.258 (32)	.786 (20)	0 (0)

Dimensions in inches (mm)

### Common Mode



### Normal Mode



# Power Line Filters Single Stage

## 12-PMF Series



### Features

- Space-saving, compact designs
- Suitable for products that must conform to FCC regulations
- Excellent attenuation for high voltage impulse
- Metal case provides effective EMI shielding
- Excellent filtering characteristics for both normal mode and common mode
- Epoxy molded for internal component reliability
- Structure provides effective shielding for noise generated externally and internally
- Operating temperature: -25°C to +85°C

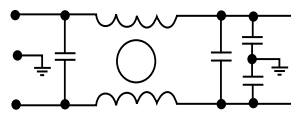
### Applications

- Digital equipment
- Computers and peripherals
- Measuring instruments
- Medical equipment
- Equipment requiring very high impulse attenuation
- Factory automation equipment
- Industrial equipment such as UPS, inverters and converters
- Telecommunications equipment
- Office automation equipment, such as copy and fax machines



### Circuit Diagram

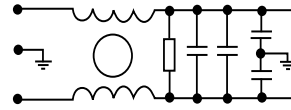
Circuit 1



Circuit 2



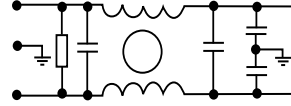
Circuit 3



Circuit 4



Circuit 5



Circuit 6



### Specifications

Model	Rated Voltage (@ 50/60Hz)	Rated Current	Leakage Current (Max.)	Circuit Diagram	Figure	Temperature Rise (Max.)
12-PMF-001-5-A	120/250VAC	1A	0.5mA	1	A	30°C
12-PMF-002-5-B		2A		2	B	
12-PMF-003-5-A		3A		4	A	
12-PMF-003-5-B		2		B		
12-PMF-006-5-A		6A		4	A	
12-PMF-006-5-C		1		C		
12-PMF-006-5-D		6		D		
12-PMF-010-5-A		10A		2	A	
12-PMF-010-5-C		3		C		
12-PMF-015-5-C		15A		5	E	
12-PMF-015-5-E		C				
12-PMF-020-5-C		20A			D	
12-PMF-020-5-D		D				
12-PMF-020-5-E		E				

Note: Test voltage: 1500VAC one minute, line to ground  
 Insulation resistance: 300 Mohm min. at 500VDC  
 Voltage drop: 1V max.  
 Discharge time: 0.4 sec. max.

# Power Line Filters Single Stage

## 12-PMF Series

Figure A

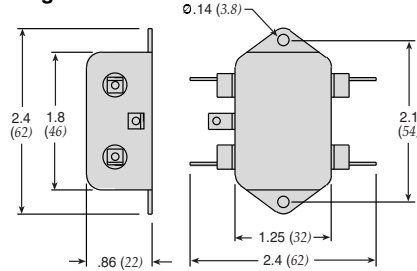


Figure B



Figure C



Figure D



Figure E

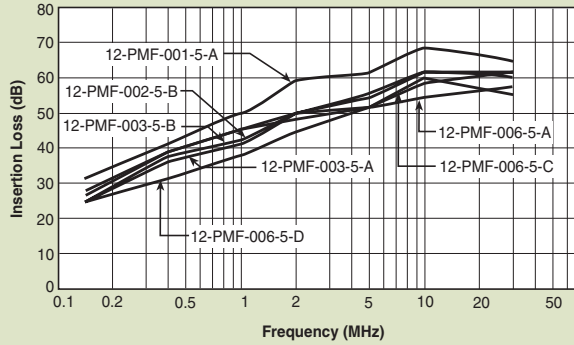


Dimensions in inches (mm)

### Common Mode



#### 12-PMF-001;-002;-003;-006



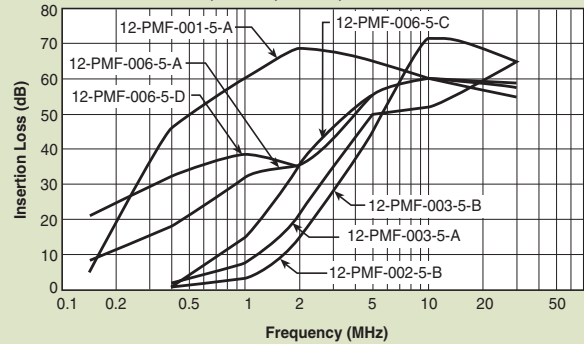
#### 12-PMF-001;-002;-003;-006



### Normal Mode



#### 12-PMF-001;-002;-003;-006



#### 12-PMF-010;-015;-020



# Power Line Filters Single Stage - Higher Current



## 62-PMB Series

### Features

- Space-saving, compact designs
- Suitable for products that must conform to FCC regulations
- Excellent attenuation for high voltage impulse
- Metal case provides effective shielding
- Excellent filtering characteristics for both normal mode and common mode
- Epoxy molded for internal component reliability
- Structure provides effective shielding for noise generated externally and internally
- Safety agency approvals pending
- Designed to be in accordance with VDE 0565 Part 3
- Operating temperature: -25°C to +85°C (including temperature rise)

### Applications

- Digital equipment
- Computers and peripherals
- Measuring instruments
- Medical equipment
- Equipment requiring very high impulse attenuation
- Factory automation equipment
- Industrial equipment such as UPS, inverters and converters
- Telecommunications equipment
- Office automation equipment, such as copy and fax machines

### Circuit Diagram



### Specifications

Model	Rated Voltage (@ 50/60Hz)	Rated Current	Leakage Current (Max.)	Capacitance		Inductance (L <sub>1</sub> )	Temperature Rise (Max.)
				C <sub>Y</sub>	C <sub>X</sub>		
62-PMB-300-5-14	250VAC	30A	0.50mA	3300pF	.47uF	1.6mH	45°C
62-PMB-400-5-14		40A				0.8mH	

Note: Test voltage: 1500VAC one minute, line to earth  
 Insulation resistance: 300 Mohm min. at 500VDC  
 Voltage drop: 1V max.  
 Discharge time: 0.4 sec. max.  
 Weight: 8.82 ounces (250 grams)

# Power Line Filters Single Stage - Higher Current

## 62-PMB Series

### 62-PMB-300-5-14 and 62-PMB-400-5-14



Dimensions in inches (mm)

### Normal Mode



### Common Mode



# Power Line Filters Single Stage - Higher Current



## 12-PMB Series

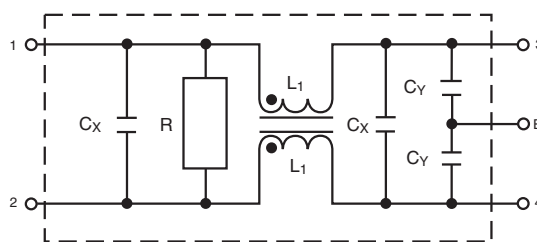
### Features

- Space-saving, compact designs
- Suitable for products that must conform to FCC regulations
- Excellent attenuation for high voltage impulse
- Metal case provides effective shielding
- Excellent filtering characteristics for both normal mode and common mode
- Epoxy molded for internal component reliability
- Structure provides effective shielding for noise generated externally and internally
- Designed to be in accordance with VDE 0565 Part 3
- Operating temperature: -25°C to +85°C

### Applications

- Digital equipment
- Computers and peripherals
- Measuring instruments
- Medical equipment
- Equipment requiring very high impulse attenuation
- Factory automation equipment
- Industrial equipment such as UPS, inverters and converters
- Telecommunications equipment
- Office automation equipment, such as copy and fax machines

### Circuit Diagram



## Specifications

Model	Rated Voltage (@ 50/60Hz)	Rated Current	Leakage Current (Max.)	Circuit Diagram	Figure	Temperature Rise (Max.)
12-PMB-025-5-A	120/250VAC	25A	0.5mA	1	A	30°C
12-PMB-030-5-A		30A				
12-PMB-035-5-B		35A				
12-PMB-050-5-B		50A	1.0mA		B	
12-PMB-100-8-C		100A				
12-PMB-120-8-C	120A	C				

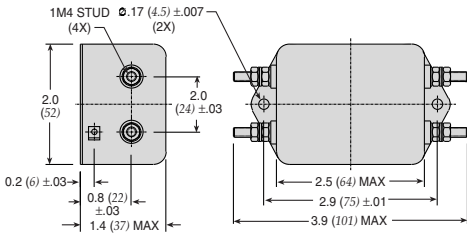
Note: Test voltage: 1500VAC one minute, line to earth  
 Insulation resistance: 300 Mohm min. at 500VDC  
 Voltage drop: 1V max.  
 Discharge time: 0.4 sec. max.  
 Weight: 8.82 ounces (250 grams)



# Power Line Filters Single Stage - Higher Current

## 12-PMB Series

**Figure A**



**Figure B**

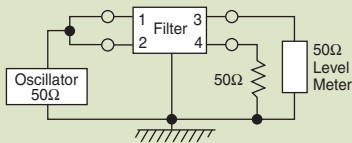


**Figure C**



Dimensions in inches (mm)

### Common Mode



#### 12-PMB-025;-030;-035



#### 12-PMB-050;-100;-120



### Normal Mode



#### 12-PMB-025;-030;-035



#### 12-PMB-050;-100;-120



# Power Line Filters DC - Higher Current



## 12-PMF & 12 PMB DC Series

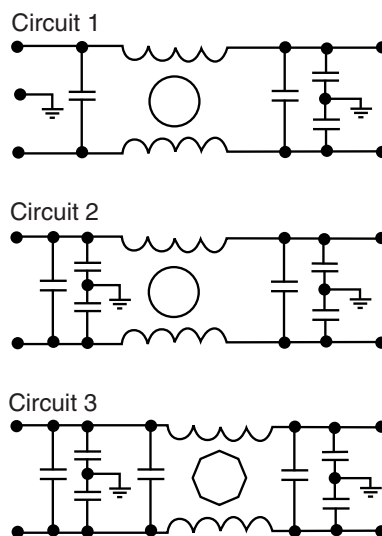
### Features

- Space-saving, compact designs
- Suitable for products that must conform to FCC regulations
- Excellent attenuation for high voltage impulse
- Metal case provides effective shielding
- Excellent filtering characteristics for both normal mode and common mode
- Epoxy molded for internal component reliability
- Structure provides effective shielding for noise generated externally and internally
- Designed to be in accordance with VDE 0565 Part 3
- Operating temperature: -40°C to +85°C

### Applications

- Digital equipment
- Computers and peripherals
- Measuring instruments
- Equipment requiring very high impulse attenuation
- Factory automation equipment
- Industrial equipment such as UPS, inverters and converters
- Telecommunications equipment

### Circuit Diagram



### Specifications

Model	Rated Voltage (@ 50/60Hz)	Rated Current	Circuit Diagram	Figure	Temperature Rise (Max.)	
12-PMF-006-DC-C	48/250 VDC	6A	1	A	30°C	
12-PMF-010-DC-C		10A				
12-PMF-015-DC-C		15A				
12-PMF-020-DC-C		20A				
12-PMF-025-DC-D		25A		1		B
12-PMB-025-DC-F						
12-PMB-030-DC-F		30A		1		C
12-PMB-035-DC-F		35A				
12-PMB-040-DC-F		40A				
12-PMB-040-DC-B		40A				
12-PMB-050-DC-B		50A		1		D
12-PMB-060-DC-B		60A				
12-PMB-080-DC-G		80A		2		E
12-PMB-080-DC-C						
12-PMB-100-DC-C		100A	3	F		
12-PMB-120-DC-C		120A				
12-PMB-140-DC-C		140A				
12-PMB-180-DC-E		180A	2	G		
12-PMB-200-DC-E		200A				
12-PMB-260-DC-E		260A				

Note: Test voltage: 1500VAC one minute, line to earth  
Insulation resistance: 300 Mohm min. at 500VDC  
Voltage drop: 1V max.

Discharge time: 0.4 sec. max.  
Weight: 8.82 ounces (250 grams)

# Power Line Filters DC - Higher Current

## 12-PMF & 12-PMB DC Series

Figure B

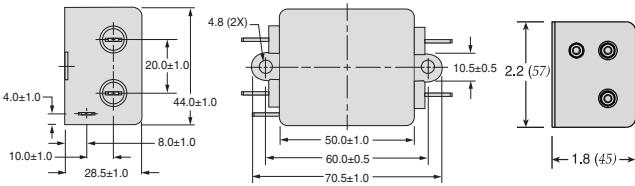


Figure C

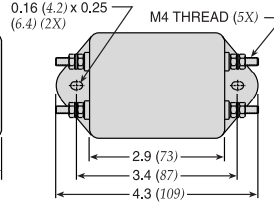


Figure A



Figure D



Figure E

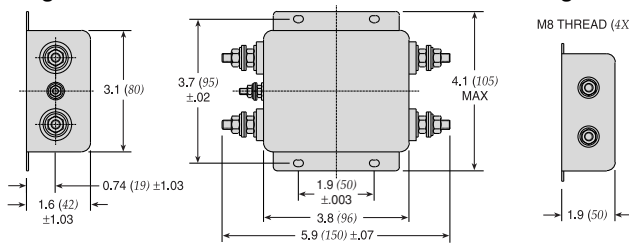


Figure F

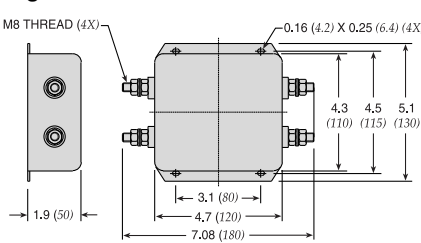
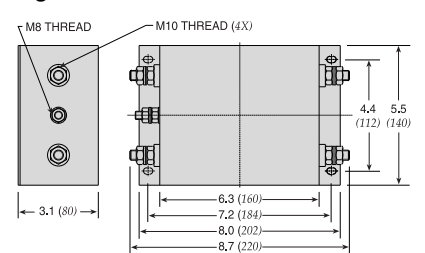


Figure G



Dimensions in inches (mm)

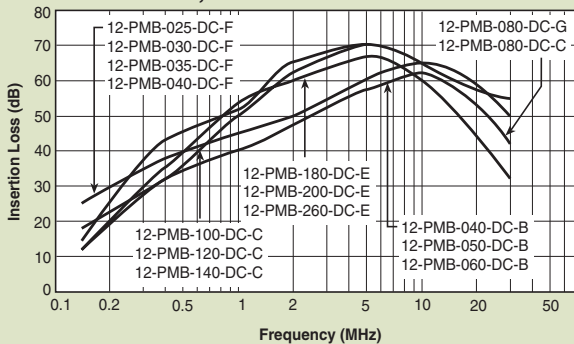
### Common Mode



#### 12-PMF-006;-010;-015;-020;-025



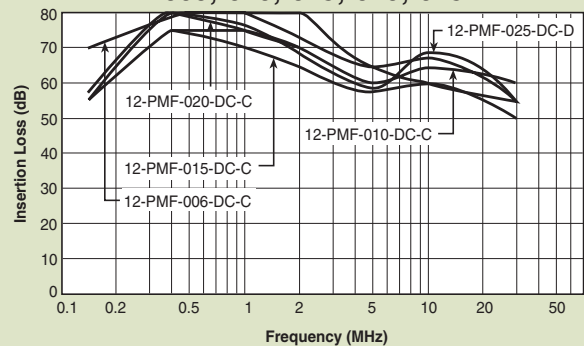
#### 12-PMB-025; thru -260



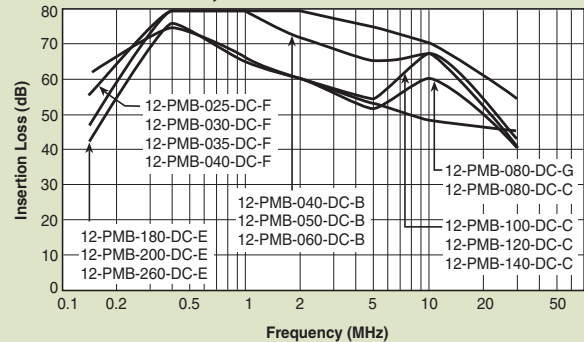
### Normal Mode



#### 12-PMF-006;-010;-015;-020;-025



#### 12-PMB-025; thru -260



# Power Line Filters Dual Stage



## 62-MMF Series

### Features

- Suitable for products that must conform to FCC regulations
- Excellent attenuation for high voltage impulse
- Metal case provides effective EMI shielding
- Two stages for excellent filtering characteristics
- Epoxy molded for reliability
- Structure provides effective shielding for noise generated both externally and internally
- Operating temperature: -25°C to +85°C (including temperature rise, see graph on page PF73)

### Applications

- Digital equipment
- Personal computers and peripherals
- Measuring instruments and medical equipment
- Telecommunications equipment
- Equipment requiring very high noise attenuation

## Circuit Diagram

62-MMF-XXX-7-11



## Specifications

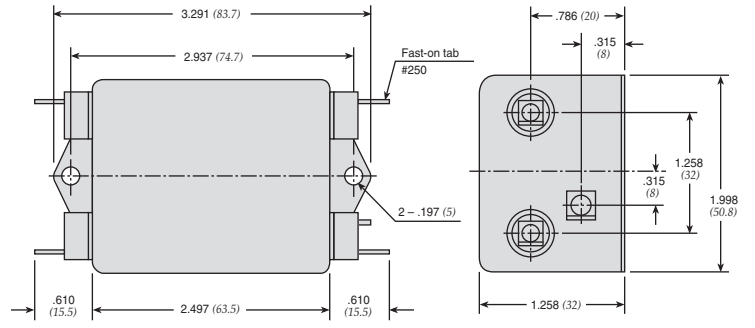
Model	Rated Voltage (@ 50/60Hz)	Rated Current	Leakage Current (Max.)	Capacitance			Inductance (L <sub>1</sub> ) (2X)	Temperature Rise (Max.)
				C <sub>Y1</sub>	C <sub>Y2</sub>	C <sub>X</sub>		
62-MMF-030-7-11	250VAC	3A	.7mA	3300pF	1000pF	0.1uF	3.7mH	30°C
62-MMF-050-7-11	250VAC	5A	.7mA	3300pF	1000pF	0.1uF	2.9mH	30°C

Note: All types are designed to meet the requirement of UL 1283, CSA 22.2, VDE 0565-3  
 Test voltage: 1500VAC one minute, line to ground  
 Insulation resistance: 300 Mohm min. at 500VDC  
 Leakage current: 0.7 mA max.  
 Voltage drop: 1V max.  
 Discharge time: 0.4 sec. max.  
 Weight: 6.0 ounces (170 grams)

# Power Line Filters Dual Stage

## 62-MMF Series

### Temperature Characteristics



### Common Mode



#### 62-MMF



### Normal Mode



#### 62-MMF



# Power Line Filters Dual Stage



## 12-MMF & 12-MMB Series

### Features

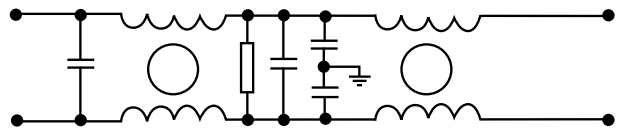
- Suitable for products that must conform to FCC regulations
- Excellent attenuation for high voltage impulse
- Metal case provides effective EMI shielding
- Two stages for excellent filtering characteristics
- Structure provides effective shielding for noise generated both externally and internally
- Operating temperature: -40°C to +85°C
- High performance
- Low leakage current

### Applications

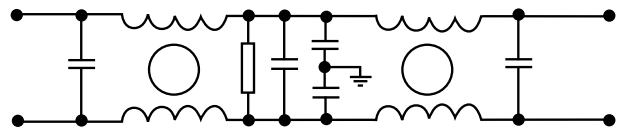
- Digital equipment
- Switching power supplies
- Personal computers and peripherals
- Measuring instruments and medical equipment
- Telecommunications equipment
- Equipment requiring very high noise attenuation

### Circuit Diagram

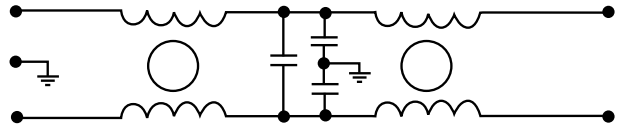
Circuit 1



Circuit 2



Circuit 3



### Specifications

Model	Rated Voltage (@ 50/60Hz)	Rated Current	Leakage Current (Max.)	Circuit Diagram	Figure	Temperature Rise (Max.)	
12-MMF-002-5-F	120/250VAC	2A	0.25mA@120VAC/ 0.5mA@250VAC	1	A	30°C	
12-MMF-003-5-F		3A			A		
12-MMF-003-5-A					B		
12-MMF-006-5-F		6A		A	2		
12-MMF-006-5-G				C			
12-MMF-008-5-B		8A		A			
12-MMF-010-5-F		10A		A1			
12-MMF-010-5-G							C
12-MMF-010-5-B							D
12-MMF-012-5-B		12A		G			
12-MMB-015-5-E		15A		E			
12-MMB-020-5-F		20A		F			
12-MMB-030-5-D		30A					
12-MMB-050-5-C		50A					

Note: All types are designed to meet the requirement of UL 1283, CSA 22.2, VDE 0565-3  
 Test voltage: 1500VAC one minute, line to ground  
 Insulation resistance: 300 Mohm min. at 500VDC  
 Voltage drop: 1V max.  
 Discharge time: 0.4 sec. max.



# Power Line Filters Dual Stage

## 12-MMF & 12-MMB Series

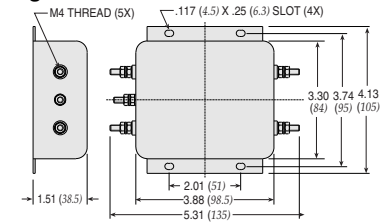
**Figure B**



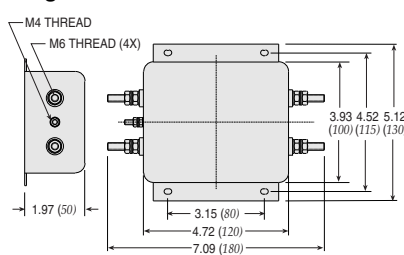
**Figure C**



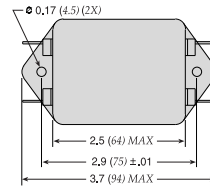
**Figure E**



**Figure F**



**Figure A**



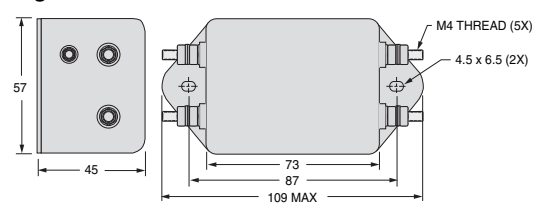
**Figure A1**



**Figure D**

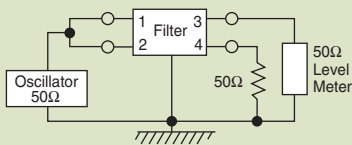


**Figure G**

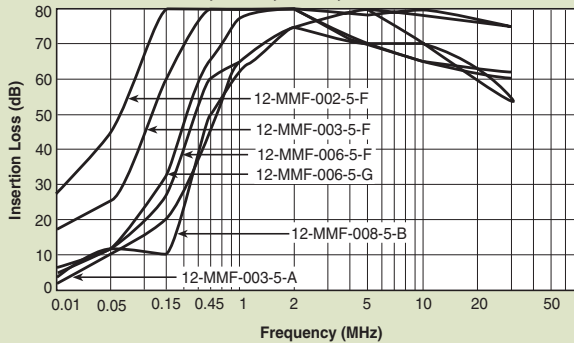


Dimensions in inches (mm)

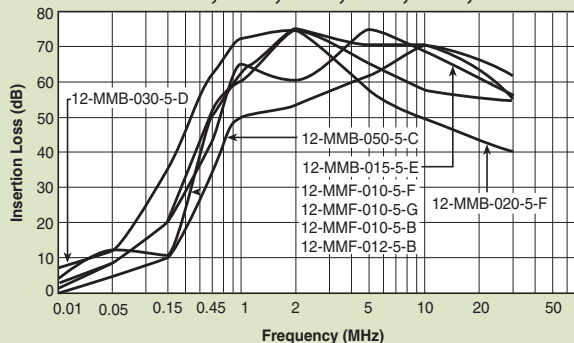
### Common Mode



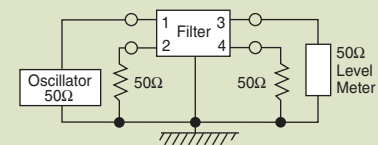
#### 12-MMF-002;-003;-006;-008



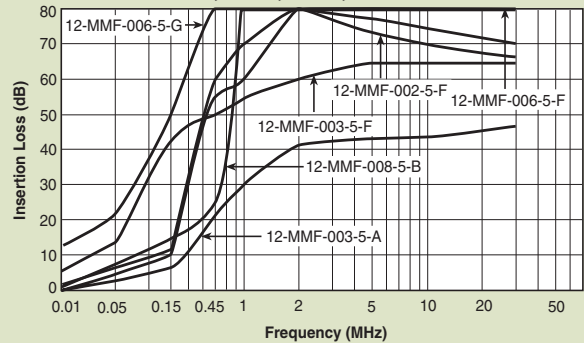
#### 12-MMF-010;-012;-015;-020;-030;-050



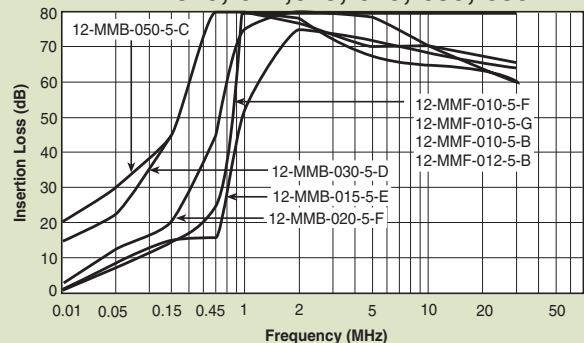
### Normal Mode



#### 12-MMF-002;-003;-006;-008



#### 12-MMF-010;-012;-015;-020;-030;-050



# Power Line Filters Dual Stage



## 12-MMF & 12-MMB Series

### Features

- Suitable for products that must conform to FCC regulations
- Excellent attenuation for high voltage impulse
- Metal case provides effective EMI shielding
- Two stages for excellent filtering characteristics
- Structure provides effective shielding for noise generated both externally and internally
- Operating temperature: -40°C to +85°C
- High performance

### Applications

- Digital equipment
- Personal computers and peripherals
- Measuring instruments and medical equipment
- Telecommunications equipment
- Equipment requiring very high noise attenuation

### Circuit Diagram

Circuit 1



Circuit 2



### Specifications

Model	Rated Voltage (@ 50/60Hz)	Rated Current	Leakage Current (Max.)	Circuit Diagram	Figure	Temperature Rise (Max.)
12-MMF-003-11-F	120/250VAC	3A	1.5mA	1	A	30°C
12-MMF-006-11-F		6A			C	
12-MMF-010-11-F		10A			B	
12-MMB-015-11-G		15A		2	D	
12-MMB-020-11-D		20A			E	
12-MMB-030-11-D		30A			F	
12-MMB-040-11-B		40A		1		
12-MMB-040-11-E						
12-MMB-050-11-H		50A				

Note: All types are designed to meet the requirement of UL 1283, CSA 22.2. VDE 0565-3  
 Test voltage: 1500VAC one minute, line to ground  
 Insulation resistance: 300 Mohm min. at 500VDC  
 Leakage current: 0.7 mA max.  
 Voltage drop: 1V max.  
 Discharge time: 0.4 sec. max.  
 Weight: 6.0 ounces (170 grams)

# Power Line Filters Dual Stage

## 12-MMF & 12-MMB Series

Figure A



Figure B



Figure C



Figure D



Figure E



Figure F



Dimensions in inches (mm)

### Common Mode



#### 12-MMF/MMB-003;-006;-010;-012;-015



#### 12-MMB-020;-030;-040;-050



### Normal Mode



#### 12-MMF/MMB-003;-006;-010;-012;-015



#### 12-MMB-020;-030;-040;-050



# Power Line Filters Dual Stage



## 12-MMF & 12-MMB Series

### Features

- Suitable for products that must conform to FCC regulations
- Excellent attenuation for high voltage impulse
- Metal case provides effective EMI shielding
- Two stages for excellent filtering characteristics
- Epoxy molded for reliability
- Structure provides effective shielding for noise generated both externally and internally
- Operating temperature: -25°C to +85°C

### Applications

- Digital equipment
- Personal computers and peripherals
- Measuring instruments and medical equipment
- Telecommunications equipment
- Equipment requiring very high noise attenuation

### Circuit Diagram

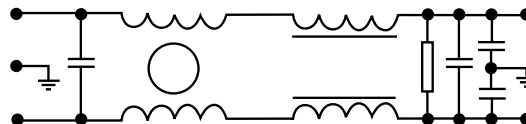
Circuit 1



Circuit 2



Circuit 3



### Specifications

Model	Rated Voltage (@ 50/60Hz)	Rated Current	Leakage Current (Max.)	Circuit Diagram	Figure	Temperature Rise (Max.)	
12-MMF-001-5-F	120/250VAC	1A	0.5mA	3	A	30°C	
12-MMF-003-5-G		3A			5uA		1
12-MMF-003-2-G			6A				
12-MMF-006-5-G		10A	0.5mA	D			
12-MMB-010-5-D		15A					
12-MMB-015-5-E		20A					
12-MMB-020-5-E		30A					

Note: All types are designed to meet the requirement of UL 1283, CSA 22.2. VDE 0565-3  
 Test voltage: 1500VAC one minute, line to ground  
 Insulation resistance: 300 Mohm min. at 500VDC  
 Leakage current: 0.7 mA max.  
 Voltage drop: 1V max.  
 Discharge time: 0.4 sec. max.  
 Weight: 6.0 ounces (170 grams)

# Power Line Filters Dual Stage

## 12-MMF & 12-MMB Series

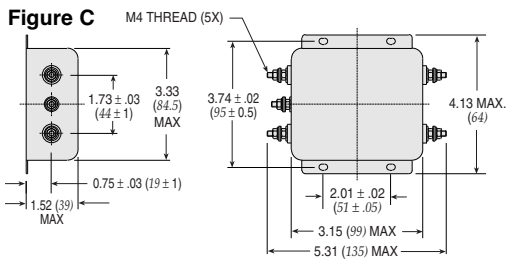
**Figure A**



**Figure B**



**Figure C**



**Figure D**



Dimensions in inches (mm)





Компания «ЭлектроПласт» предлагает заключение долгосрочных отношений при поставках импортных электронных компонентов на взаимовыгодных условиях!

Наши преимущества:

- Оперативные поставки широкого спектра электронных компонентов отечественного и импортного производства напрямую от производителей и с крупнейших мировых складов;
- Поставка более 17-ти миллионов наименований электронных компонентов;
- Поставка сложных, дефицитных, либо снятых с производства позиций;
- Оперативные сроки поставки под заказ (от 5 рабочих дней);
- Экспресс доставка в любую точку России;
- Техническая поддержка проекта, помощь в подборе аналогов, поставка прототипов;
- Система менеджмента качества сертифицирована по Международному стандарту ISO 9001;
- Лицензия ФСБ на осуществление работ с использованием сведений, составляющих государственную тайну;
- Поставка специализированных компонентов (Xilinx, Altera, Analog Devices, Intersil, Interpoint, Microsemi, Aeroflex, Peregrine, Syfer, Eurofarad, Texas Instrument, Miteq, Cobham, E2V, MA-COM, Hittite, Mini-Circuits, General Dynamics и др.);

Помимо этого, одним из направлений компании «ЭлектроПласт» является направление «Источники питания». Мы предлагаем Вам помощь Конструкторского отдела:

- Подбор оптимального решения, техническое обоснование при выборе компонента;
- Подбор аналогов;
- Консультации по применению компонента;
- Поставка образцов и прототипов;
- Техническая поддержка проекта;
- Защита от снятия компонента с производства.



#### Как с нами связаться

**Телефон:** 8 (812) 309 58 32 (многоканальный)

**Факс:** 8 (812) 320-02-42

**Электронная почта:** [org@eplast1.ru](mailto:org@eplast1.ru)

**Адрес:** 198099, г. Санкт-Петербург, ул. Калинина, дом 2, корпус 4, литера А.