

Aluminum Capacitors Axial High Temperature, High Ripple Current



Fig. 1

QUICK REFERENCE DATA	
DESCRIPTION	VALUE
Nominal case sizes (Ø D x L in mm)	10 x 30 to 21 x 38
Rated capacitance range, C_R	47 μ F to 6800 μ F
Tolerance on C_R	± 20 %
Rated voltage range, U_R	16 V to 100 V
Category temperature range	- 40 °C to + 125 °C
Endurance test at 150 °C	1000 h
Endurance test at 125 °C	4000 h
Useful life at 125 °C	8000 h
Useful life at 85 °C, 1.4 x I_R applied	40 000 h
Shelf life at 0 V, 125 °C	1000 h (100 V: 500 h)
Shelf life at 0 V, 150 °C	≤ 63 V: 500 h
Based on sectional specification	IEC 60384-4/EN 130300
Climatic category IEC 60068	40/125/56

FEATURES

- Extra long useful life: Up to 8000 h at 125 °C
- Extended temperature range: Usable up to 150 °C
- Lowest ESR levels providing very high ripple current capability
- Miniaturized, high CV-product per unit volume
- Polarized aluminum electrolytic capacitors, non-solid electrolyte
- Axial leads, cylindrical aluminum case, insulated with a blue sleeve
- Taped versions up to case Ø 15 mm x 30 mm available for automatic insertion
- Lead diameter Ø d = 1.0 mm, available on request
- Material categorization: For definitions of compliance please see www.vishay.com/doc?99912

**RoHS
COMPLIANT**

APPLICATIONS

- Automotive, industrial and telecommunication
- Smoothing, filtering, buffering
- Low mounting height applications, vibration and shock resistant
- SMPS and standard power supplies

MARKING

The capacitors are marked (where possible) with the following information:

- Rated capacitance (in μ F)
- Tolerance on rated capacitance, code letter in accordance with IEC 60062 (M for ± 20 %)
- Rated voltage (in V)
- Upper category temperature (125 °C)
- Date code in accordance with IEC 60062
- Code for factory of origin
- Name of manufacturer
- Negative terminal identification
- Series number (120)

SELECTION CHART FOR C_R , U_R , AND RELEVANT NOMINAL CASE SIZE (Ø D x L in mm)					
C_R (μ F)	U_R (V)				
	16	25	40	63	100
47	-	-	-	-	10 x 30
68	-	-	-	-	12.5 x 30
100	-	-	-	10 x 30	12.5 x 30
150	-	-	-	12.5 x 30	15 x 30
220	-	-	10 x 30	12.5 x 30	18 x 30
330	-	-	12.5 x 30	15 x 30	18 x 38
470	-	10 x 30	12.5 x 30	18 x 30	21 x 38
680	10 x 30	12.5 x 30	15 x 30	18 x 38	-
1000	12.5 x 30	12.5 x 30	18 x 30	21 x 38	-
1500	12.5 x 30	15 x 30	18 x 38	-	-
2200	15 x 30	18 x 30	21 x 38	-	-
3300	18 x 30	18 x 38	-	-	-
4700	18 x 38	21 x 38	-	-	-
6800	21 x 38	-	-	-	-

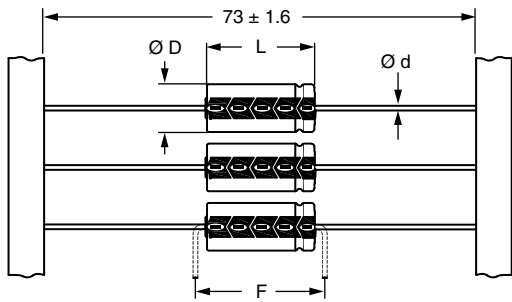
DIMENSIONS in millimeters AND AVAILABLE FORMS

Form BR: Taped on reel
Case $\varnothing D \times L = 6.5 \text{ mm} \times 18 \text{ mm}$ to $15 \text{ mm} \times 30 \text{ mm}$

Fig. 2 - Form BR



Form AA: Axial in box
Case $\varnothing D \times L = 10 \text{ mm} \times 30 \text{ mm}$ to $21 \text{ mm} \times 38 \text{ mm}$

Fig. 3 - Form AA

Table 1

AXIAL; DIMENSIONS in millimeters, MASS, AND PACKAGING QUANTITIES								
NOMINAL CASE SIZE $\varnothing D \times L$ (mm)	AXIAL: FORM AA AND BR					MASS (g)	PACKAGING QUANTITIES	
	$\varnothing d$ (1)	I	$\varnothing D_{\text{max.}}$	$L_{\text{max.}}$	$F_{\text{min.}}$		FORM AA	FORM BR
10 x 30	0.8	55 ± 1	10.5	30.5	35	≈ 4.8	340	500
12.5 x 30	0.8	55 ± 1	13.0	30.5	35	≈ 7.4	260	400
15 x 30	0.8	55 ± 1	15.5	30.5	35	≈ 11.7	200	250
18 x 30	0.8	55 ± 1	18.5	30.5	35	≈ 12.9	120	-
18 x 38	0.8	34 ± 1	18.5	39.5	44	≈ 19.0	125	-
21 x 38	0.8	34 ± 1	21.5	39.5	44	≈ 24.0	100	-

Notes

- (1) Lead diameter $\varnothing d = 1.0 \text{ mm}$, available on request.
- For detailed tape dimensions, please see www.vishay.com/doc?28361.



Mounting holes

Case $\varnothing D \times L = 15 \text{ mm} \times 30 \text{ mm}$ to $21 \text{ mm} \times 38 \text{ mm}$
Especially for applications with severe shocks and vibrations

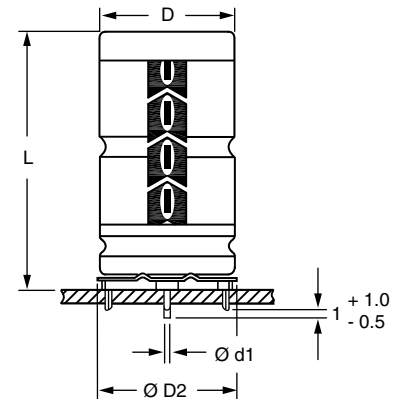

 Fig. 4 - Mounting hole diagram and outline; **form MR:** With mounting ring and pins

Table 2

MOUNTING RING; DIMENSIONS in millimeters, MASS, AND PACKAGING QUANTITIES									
NOMINAL CASE SIZE $\varnothing D \times L$	CASE CODE	MOUNTING RING: FORM MR						MASS (g)	PACKAGING QUANTITIES
		$\varnothing d1$	$\varnothing d2$	$\varnothing D_{\text{max.}}$	$\varnothing D2_{\text{max.}}$	D3	$L_{\text{max.}}$		
15 x 30	02	0.8	$1.0 + 0.4$	15.5	17.5	16.5 ± 0.2	33	≈ 8.6	200
18 x 30	03	0.8	$1.0 + 0.4$	18.5	19.5	18.5 ± 0.2	33	≈ 11.5	240
18 x 38	04	0.8	$1.0 + 0.4$	18.5	19.5	18.5 ± 0.2	42	≈ 14.0	100
21 x 38	05	0.8	$1.0 + 0.4$	21.5	22.5	21.5 ± 0.2	42	≈ 19.2	100



ELECTRICAL DATA	
SYMBOL	DESCRIPTION
C _R	Rated capacitance at 100 Hz, tolerance ± 20 %
I _R	Rated RMS ripple current at 10 kHz, 125 °C
I _{L1}	Max. leakage current after 1 min at U _R
I _{L5}	Max. leakage current after 5 min at U _R
ESR	Equivalent series resistance at 100 Hz (calculated from tan δ _{max.} and C _R)
Z	Max. impedance at 10 kHz

ORDERING EXAMPLE

Electrolytic capacitor 120 series

1000 µF/16 V; ± 20 %

Nominal case size: Ø 12.5 mm x 30 mm; form BR

Ordering code: MAL212025102E3

Former 12NC: 2222 120 25102

Note

- Unless otherwise specified, all electrical values in Table 3 apply at T_{amb} = 20 °C, P = 86 kPa to 106 kPa, RH = 45 % to 75 %.

Table 3

ELECTRICAL DATA AND ORDERING INFORMATION													
U _R (V)	C _R 100 Hz (µF)	NOMINAL CASE SIZE Ø D x L (mm)	I _R 10 kHz 125 °C (mA)	I _{L1} 1 min (µA)	I _{L5} 5 min (µA)	TYP. ESR 100 Hz (mΩ)	MAX. ESR 100 Hz (mΩ)	TYP. ESR 10 kHz (mΩ)	MAX. ESR 10 kHz (mΩ)	Z MAX. 10 kHz (mΩ)	ORDERING CODE MAL2120.....		
											IN BOX FORM AA	TAPED ON REEL FORM BR	MOUNTING RING FORM MR
16	680	10 x 30	2100	171	84	106	177	44	74	78	15681E3	25681E3	-
	1000	12.5 x 30	2550	232	104	77	128	35	58	61	15102E3	25102E3	-
	1500	12.5 x 30	2650	328	136	60	100	32	53	53	15152E3	25152E3	-
	2200	15 x 30	2940	462	181	48	79	28	46	46	15222E3	25222E3	45222E3
	3300	18 x 30	3430	674	251	41	68	26	43	43	15332E3	-	45332E3
	4700	18 x 38	4350	942	341	27	45	18	29	29	15472E3	-	45472E3
	6800	21 x 38	4590	1346	475	26	43	18	29	29	15682E3	-	45682E3
25	470	10 x 30	2100	181	87	112	187	45	74	84	16471E3	26471E3	-
	680	12.5 x 30	2550	244	108	81	136	35	59	64	16681E3	26681E3	-
	1000	12.5 x 30	2600	340	140	64	107	32	53	55	16102E3	26102E3	-
	1500	15 x 30	2890	490	190	49	82	28	46	46	16152E3	26152E3	46152E3
	2200	18 x 30	3310	700	260	43	71	27	44	44	16222E3	-	46222E3
	3300	18 x 38	4350	1030	370	28	47	18	29	29	16332E3	-	46332E3
	4700	21 x 38	4470	1450	510	27	44	18	29	29	16472E3	-	46472E3
40	220	10 x 30	1990	146	75	192	320	52	87	124	17221E3	27221E3	-
	330	12.5 x 30	2430	198	93	130	216	37	62	83	17331E3	27331E3	-
	470	12.5 x 30	2550	266	115	101	169	35	58	70	17471E3	27471E3	-
	680	15 x 30	2840	366	149	75	125	30	50	55	17681E3	27681E3	47681E3
	1000	18 x 30	3150	520	200	59	99	28	47	49	17102E3	-	47102E3
	1500	18 x 38	4130	760	280	39	65	19	31	32	17152E3	-	47152E3
	2200	21 x 38	4170	1096	392	34	56	19	31	31	17222E3	-	47222E3
63	100	10 x 30	1560	116	65	297	495	92	154	249	18101E3	28101E3	-
	150	12.5 x 30	2050	153	78	195	325	61	102	162	18151E3	28151E3	-
	220	12.5 x 30	2150	206	95	149	249	55	92	126	18221E3	28221E3	-
	330	15 x 30	2510	289	123	105	175	44	73	91	18331E3	28331E3	48331E3
	470	18 x 30	2860	395	158	81	135	38	64	74	18471E3	-	48471E3
	680	18 x 38	3720	554	211	55	92	26	43	49	18681E3	-	48681E3
	1000	21 x 38	3780	796	292	44	74	25	41	43	18102E3	-	48102E3
100	47	10 x 30	760	96	59	760	1269	349	581	720	19479E3	29479E3	-
	68	12.5 x 30	1030	122	67	531	885	246	410	503	19689E3	29689E3	-
	100	12.5 x 30	1140	160	80	389	648	196	327	381	19101E3	29101E3	-
	150	15 x 30	1480	220	100	266	443	137	229	262	19151E3	29151E3	49151E3
	220	18 x 30	1960	304	128	181	302	95	158	179	19221E3	-	49221E3
	330	18 x 38	2550	436	172	120	200	62	104	117	19331E3	-	49331E3
	470	21 x 38	2800	604	228	92	154	52	86	94	19471E3	-	49471E3



ADDITIONAL ELECTRICAL DATA			
PARAMETER	CONDITIONS	VALUE	
		AXIAL	MOUNTING RING
Voltage			
Surge voltage		$U_s \leq 1.15 \times U_R$	
Reverse voltage		$U_{rev} \leq 1 \text{ V}$	
Current			
Leakage current	After 1 min at U_R	$I_{L1} \leq 0.012 C_R \times U_R + 40 \mu\text{A}$	
	After 5 min at U_R	$I_{L5} \leq 0.004 C_R \times U_R + 40 \mu\text{A}$	
Inductance			
Equivalent series inductance (ESL)	Case $\varnothing D \times L$ mm:		
	10 x 30	Typ. 38 nH	
	12.5 x 30	Typ. 46 nH	
	15 x 30	Typ. 48 nH	Typ. 39 nH
	18 x 30	Typ. 50 nH	Typ. 39 nH
	18 x 38	Typ. 54 nH	Typ. 39 nH
	21 x 38	Typ. 59 nH	Typ. 39 nH

CAPACITANCE (C)

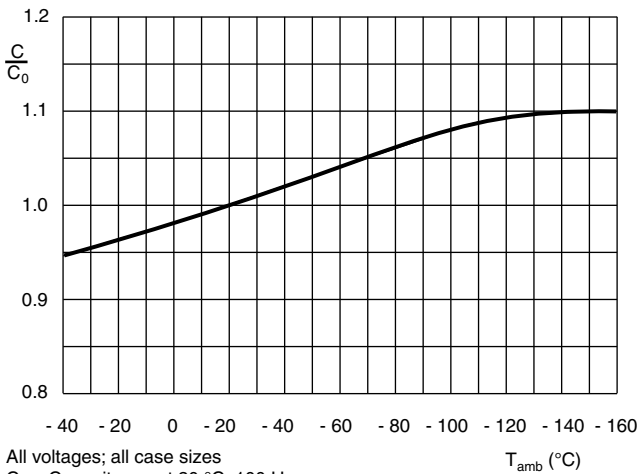

Fig. 5 - Typical multiplier of capacitance as a function of ambient temperature

EQUIVALENT SERIES RESISTANCE (ESR)

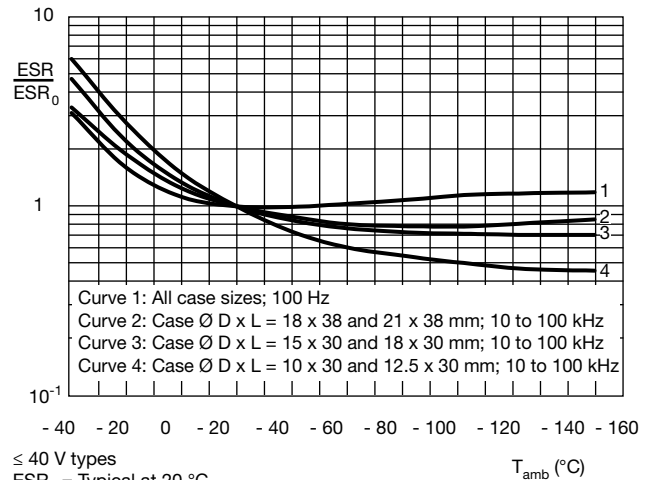

Fig. 6 - Typical multiplier of ESR as a function of ambient temperature at different frequencies

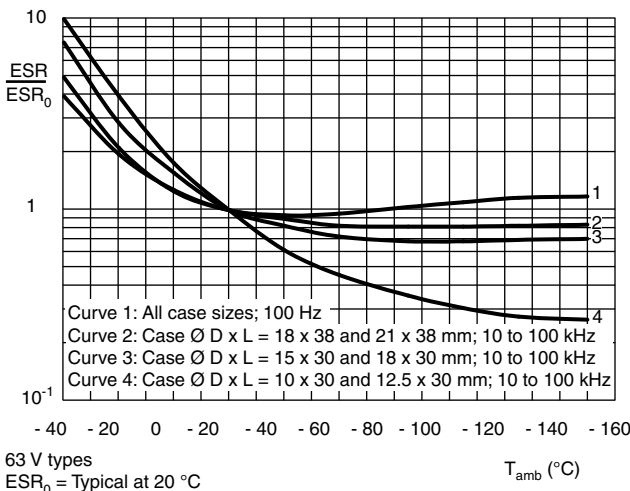

Fig. 7 - Typical multiplier of ESR as a function of ambient temperature at different frequencies

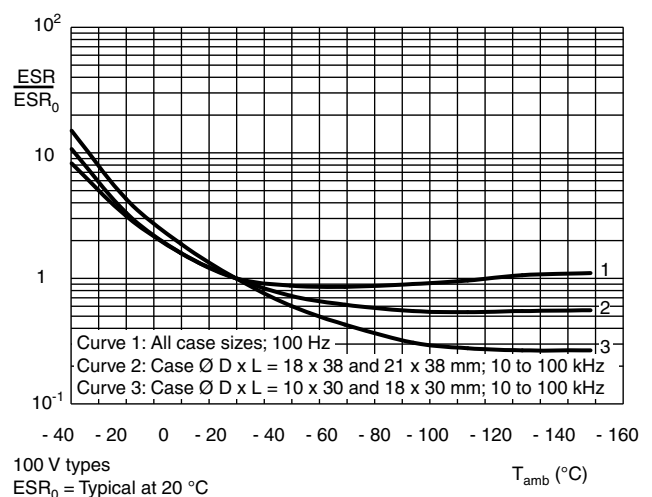
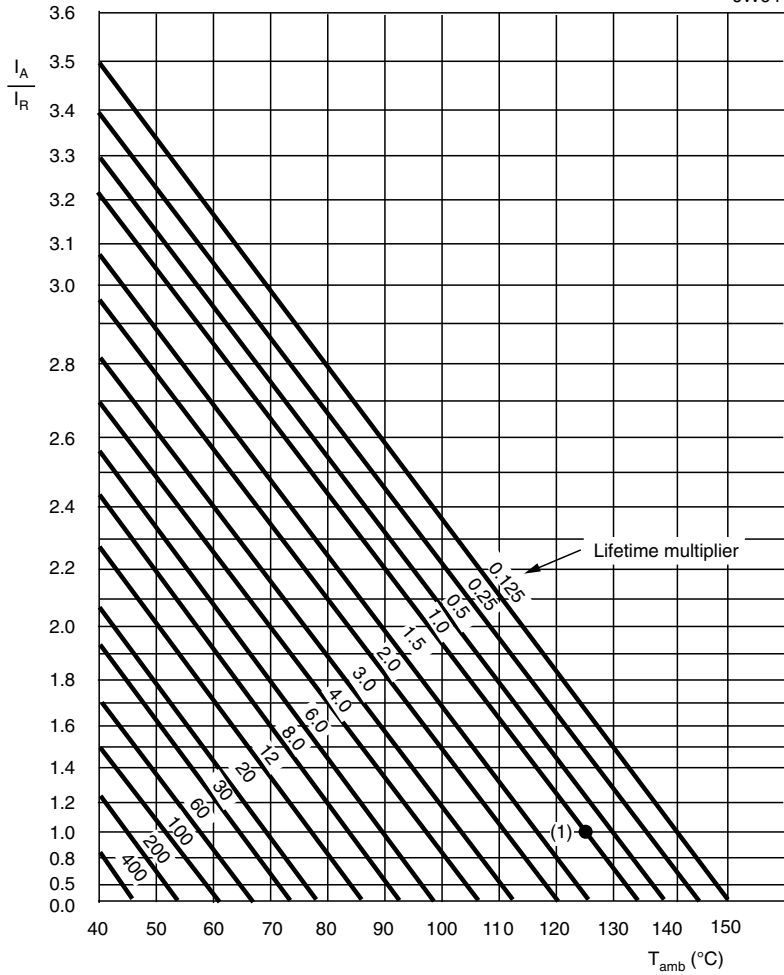

Fig. 8 - Typical multiplier of ESR as a function of ambient temperature at different frequencies

RIPPLE CURRENT AND USEFUL LIFE

JW64



I_A = Actual ripple current at 10 kHz
 I_R = Rated ripple current at 10 kHz, 125 °C
 (1) Useful life at 125 °C and I_R applied: 8000 h

Fig. 9 - Multiplier of useful life as a function of ambient temperature and ripple current load

Table 4

MULTIPLIER OF RIPPLE CURRENT (I_R) AS A FUNCTION OF FREQUENCY				
FREQUENCY (Hz)	I_R MULTIPLIER			
	$U_R = 16\text{ V TO }40\text{ V}$ CASE SIZES (10 x 30 to 15 x 30) mm	$U_R = 16\text{ V TO }40\text{ V}$ CASE SIZES (18 x 30 to 21 x 38) mm	$U_R = 63\text{ V AND }100\text{ V}$ CASE SIZES (10 x 30 to 15 x 30) mm	$U_R = 63\text{ V AND }100\text{ V}$ CASE SIZES (18 x 30 to 21 x 38) mm
50	0.37	0.54	0.23	0.44
100	0.48	0.63	0.32	0.56
300	0.69	0.75	0.53	0.76
1000	0.86	0.81	0.77	0.88
3000	0.96	0.87	0.93	0.94
$\geq 10\ 000$	1.00	1.00	1.00	1.00



Table 5

TEST PROCEDURES AND REQUIREMENTS			
TEST		PROCEDURE (quick reference)	REQUIREMENTS
NAME OF TEST	REFERENCE		
Endurance	IEC 60384-4/ EN 130300 subclause 4.13	$T_{amb} = 125\text{ }^{\circ}\text{C}$; U_R applied; 4000 h $T_{amb} = 150\text{ }^{\circ}\text{C}$; U_R applied; 1000 h	$\Delta C/C$: $\pm 15\%$ $\tan \delta \leq 1.3 \times \text{spec. limit}$ $Z \leq 2 \times \text{spec. limit}$ $I_{L5} \leq \text{spec. limit}$
Useful life	CECC 30301 subclause 1.8.1	$T_{amb} = 125\text{ }^{\circ}\text{C}$; U_R and I_R applied; 8000 h	$\Delta C/C$: $\pm 45\%$ $\tan \delta \leq 3 \times \text{spec. limit}$ $Z \leq 3 \times \text{spec. limit}$ $I_{L5} \leq \text{spec. limit}$ no short or open circuit total failure percentage: $\leq 1\%$
Shelf life (storage at high temperature)	IEC 60384-4/ EN 130300 subclause 4.17	$T_{amb} = 125\text{ }^{\circ}\text{C}$; no voltage applied; 1000 h (100 V: 500 h) $T_{amb} = 150\text{ }^{\circ}\text{C}$; no voltage applied; 500 h for voltages: $\leq 63\text{ V}$ After test: U_R to be applied for 30 min, 24 h to 48 h before measurement	$\Delta C/C$, $\tan \delta$, Z : For requirements see "Endurance test" above $I_{L5} \leq 2 \times \text{spec. limit}$
Reverse voltage	IEC 60384-4/ EN 130300 subclause 4.15	$T_{amb} = 125\text{ }^{\circ}\text{C}$: 125 h at $U = -1\text{ V}$ Followed by 125 h at U_R	$\Delta C/C$: $\pm 20\%$ $\tan \delta \leq \text{spec. limit}$ $I_{L5} \leq \text{spec. limit}$



Disclaimer

ALL PRODUCT, PRODUCT SPECIFICATIONS AND DATA ARE SUBJECT TO CHANGE WITHOUT NOTICE TO IMPROVE RELIABILITY, FUNCTION OR DESIGN OR OTHERWISE.

Vishay Intertechnology, Inc., its affiliates, agents, and employees, and all persons acting on its or their behalf (collectively, "Vishay"), disclaim any and all liability for any errors, inaccuracies or incompleteness contained in any datasheet or in any other disclosure relating to any product.

Vishay makes no warranty, representation or guarantee regarding the suitability of the products for any particular purpose or the continuing production of any product. To the maximum extent permitted by applicable law, Vishay disclaims (i) any and all liability arising out of the application or use of any product, (ii) any and all liability, including without limitation special, consequential or incidental damages, and (iii) any and all implied warranties, including warranties of fitness for particular purpose, non-infringement and merchantability.

Statements regarding the suitability of products for certain types of applications are based on Vishay's knowledge of typical requirements that are often placed on Vishay products in generic applications. Such statements are not binding statements about the suitability of products for a particular application. It is the customer's responsibility to validate that a particular product with the properties described in the product specification is suitable for use in a particular application. Parameters provided in datasheets and/or specifications may vary in different applications and performance may vary over time. All operating parameters, including typical parameters, must be validated for each customer application by the customer's technical experts. Product specifications do not expand or otherwise modify Vishay's terms and conditions of purchase, including but not limited to the warranty expressed therein.

Except as expressly indicated in writing, Vishay products are not designed for use in medical, life-saving, or life-sustaining applications or for any other application in which the failure of the Vishay product could result in personal injury or death. Customers using or selling Vishay products not expressly indicated for use in such applications do so at their own risk. Please contact authorized Vishay personnel to obtain written terms and conditions regarding products designed for such applications.

No license, express or implied, by estoppel or otherwise, to any intellectual property rights is granted by this document or by any conduct of Vishay. Product names and markings noted herein may be trademarks of their respective owners.

Material Category Policy

Vishay Intertechnology, Inc. hereby certifies that all its products that are identified as RoHS-Compliant fulfill the definitions and restrictions defined under Directive 2011/65/EU of The European Parliament and of the Council of June 8, 2011 on the restriction of the use of certain hazardous substances in electrical and electronic equipment (EEE) - recast, unless otherwise specified as non-compliant.

Please note that some Vishay documentation may still make reference to RoHS Directive 2002/95/EC. We confirm that all the products identified as being compliant to Directive 2002/95/EC conform to Directive 2011/65/EU.

Vishay Intertechnology, Inc. hereby certifies that all its products that are identified as Halogen-Free follow Halogen-Free requirements as per JEDEC JS709A standards. Please note that some Vishay documentation may still make reference to the IEC 61249-2-21 definition. We confirm that all the products identified as being compliant to IEC 61249-2-21 conform to JEDEC JS709A standards.



Компания «ЭлектроПласт» предлагает заключение долгосрочных отношений при поставках импортных электронных компонентов на взаимовыгодных условиях!

Наши преимущества:

- Оперативные поставки широкого спектра электронных компонентов отечественного и импортного производства напрямую от производителей и с крупнейших мировых складов;
- Поставка более 17-ти миллионов наименований электронных компонентов;
- Поставка сложных, дефицитных, либо снятых с производства позиций;
- Оперативные сроки поставки под заказ (от 5 рабочих дней);
- Экспресс доставка в любую точку России;
- Техническая поддержка проекта, помощь в подборе аналогов, поставка прототипов;
- Система менеджмента качества сертифицирована по Международному стандарту ISO 9001;
- Лицензия ФСБ на осуществление работ с использованием сведений, составляющих государственную тайну;
- Поставка специализированных компонентов (Xilinx, Altera, Analog Devices, Intersil, Interpoint, Microsemi, Aeroflex, Peregrine, Syfer, Eurofarad, Texas Instrument, Miteq, Cobham, E2V, MA-COM, Hittite, Mini-Circuits, General Dynamics и др.);

Помимо этого, одним из направлений компании «ЭлектроПласт» является направление «Источники питания». Мы предлагаем Вам помощь Конструкторского отдела:

- Подбор оптимального решения, техническое обоснование при выборе компонента;
- Подбор аналогов;
- Консультации по применению компонента;
- Поставка образцов и прототипов;
- Техническая поддержка проекта;
- Защита от снятия компонента с производства.



Как с нами связаться

Телефон: 8 (812) 309 58 32 (многоканальный)

Факс: 8 (812) 320-02-42

Электронная почта: org@eplast1.ru

Адрес: 198099, г. Санкт-Петербург, ул. Калинина, дом 2, корпус 4, литера А.